

# PRICE LIST 2024

## FURNITURE

SWEDISH KRONA, EXCL. VAT / 11.2023

FRITZ HANSEN

# SENAB

## Färgmarkeringar och/eller symboler för hållbara alternativ i prislistan:

### Mörkgrön markering eller symbol

Miljömärkt produkt – Möbler där hela den sammansatta varan har en typ 1 miljömärkning enligt ISO 14024 med Svanen, Möbelfakta, EU Ecolabel eller annan likvärdig märkning.

### Ljusgrön markering eller symbol

Hållbarhetsmärkt produkt eller beståndsdel – Möbler där hela eller delar av den sammansatta varan är hållbarhetsmärkt, exempelvis med FSC, EU Ecolabel eller OEKO-TEX®. Leverantören ska kunna ge mer detaljerad information om vilka delar eller variationer som är hållbarhetsmärka vid begäran.

### Orange markering eller symbol

Klimatberäknad produkt – Produkt med dokumenterad miljövarudeklaration (EPD) enligt ISO 14025.

### Lila markering eller symbol

Produkt med återvunnet eller förnybart material (enligt definitionerna i ISO 14021). Leverantören ska kunna ge information om andel (%) återvunnet och/eller förnybart (biobaserat) vid begäran. Märkning av återvinningsbart material utgår.

### Blå markering eller symbol

Demonterbar produkt – Produkt som är demonterbar till olika komponenter och beståndsdelar som i första hand möjliggör återbruk och i andra hand materialåtervinning när produkten nått sin fulla livslängd. Produkten ska vara designad för renovering, det vill säga att det ska vara enkelt att reparera och byta ut moduler, komponenter och beståndsdelar som slits över tid. Exempelvis ska ytskikt, som bordsskivor, textil och stoppning kunna tas isär, avlägsnas och ersättas med hjälp av vanligt förekommande manuella verktyg, ej specialverktyg. Enklare reparationer och utbytesarbeten ska kunna utföras av en lekman. Om det krävs fackmanakunskap för mer avancerade arbeten ska det framgå av anvisningarna som leverantören ska kunna ge vid begäran. Anvisningarna ska innehålla en sprängskiss, steg för steg beskrivning inklusive vilka verktyg som krävs samt hur möbelns ingående delar bör källsorteras.

# CONTENT

## 03 • GENERAL TERMS AND CONDITIONS

### CHAIRS

- 05 • Ant™
- 06 • Series 7™
- 07 • Series 7™
- 08 • Series 7™
- 09 • Children's Chairs / Junior
- 10 • Dot™ / High Dot™
- 11 • Grand Prix™
- 12 • Grand Prix™
- 13 • Grand Prix™
- 14 • Lily™
- 15 • Drop™
- 16 • Little Giraffe™
- 17 • Oxford™
- 18 • Oxford™
- 19 • NO1™
- 20 • NO2™ Recycle
- 21 • NAP™
- 22 • Vico Duo™
- 23 • Vico Duo™
- 24 • China Chair™
- 25 • Carimate™
- 26 • Taburet

### LOUNGE

- 27 • Series 3300™
- 28 • Egg™
- 29 • Swan™
- 30 • Oksen™
- 31 • Pot™
- 32 • Lissoni Sofa™
- 33 • Ro™
- 34 • Fri™
- 35 • VIA57™
- 36 • Fred™
- 37 • Let™

### SOFAS

- 38 • Series 3300™
- 39 • Swan Sofa™
- 40 • Lissoni Sofa™
- 41 • Lissoni Sofa™
- 42 • Alphabet™ Sofa Series
- 43 • Alphabet™ Sofa Series
- 44 • Favn™
- 45 • Lune™
- 46 • Lune™
- 47 • Ro™ Sofa
- 48 • Plenum™

### TABLES

- 49 • Superellipse™
- 50 • Superellipse™
- 51 • Supercircular™
- 52 • Circular
- 53 • Rectangular
- 54 • Egg™ Table
- 55 • FH3605™
- 56 • AJ Trolley™
- 57 • Stub™
- 58 • Essay™
- 59 • Essay™
- 60 • Analog™
- 61 • Join™
- 62 • Pluralis™
- 63 • Pluralis™
- 64 • Pluralis™
- 65 • Little Friend™
- 66 • Planner™ Table Series

### SHELVING

- 67 • Planner™ Shelving

### OTHER

- 68 • Coat Tree™ / Coat Tree™ Wall

### SPARE PARTS

- 69 • Spare Parts
- 70 • Spare Parts

### SURFACE SELECTION

- 71 • Surface Selection



**ANT™**  
**ARNE JACOBSEN 1952**

**11.2023**

The Ant™ comes in clear lacquered, coloured ash or lacquered veneer. All chairs are made of pressure moulded veneer and are stackable. The shell is also available in front upholstered versions in a wide range of textiles and leather types. The base comes with 3 or 4 legs made of chromed or powder coated tubular steel.

MODEL	DESCRIPTION	COLOURED ASH VENEER	LACQUERED VENEER	CLEAR LACQUERED VENEER
3101	Chair, 4 legs, stackable (max 12 pcs), seat height 44 cm or 46 cm, chromed or powder coated tubular steel base	3.359	3.519	4.959

COLOURED ASH AND LACQUERED VENEER - SEE THE SURFACE SELECTION  
PALE ROSE (610/615), WILD ROSE (630/635), VENETIAN RED (670/675), PARADISE ORANGE (570/575), BURNT YELLOW (470/475), TRUE YELLOW (460/465), LIGHT BEIGE (130/135), DEEP CLAY (140/145), OLIVE GREEN (920/925), LAVENDER BLUE (810/815), DUSK BLUE (850/855), MIDNIGHT BLUE (890/895), EVERGREEN (950/955), BLACK (190/195), NINE GREY (150/155), WHITE (100/105)

CLEAR LACQUERED VENEER - SEE THE SURFACE SELECTION  
MAPLE, BEECH, ASH, CHERRY, OREGON PINE, ELM, OAK, WALNUT, OAK - DARK STAINED, OAK - FULL DARK STAINED

BASE COLOURS  
SILVER GREY, WARM GRAPHITE, BROWN BRONZE, BLACK, WHITE (ONLY WITH WHITE SHELL), NINE GREY, CHROME

**FRONT UPHOLSTERED - COLOURED ASH VENEER**

MODEL	DESCRIPTION	CHRISTIANSHAVN	CATEGORY 1	CATEGORY 2	CATEGORY 3	CATEGORY 4	CATEGORY 5
3101	Chair, 4 legs, seat height 44 cm or 46 cm, chromed or powder coated tubular steel base	5.119	5.599	5.999	8.399	9.999	13.199

**FRONT UPHOLSTERED - LACQUERED VENEER**

MODEL	DESCRIPTION	CHRISTIANSHAVN	CATEGORY 1	CATEGORY 2	CATEGORY 3	CATEGORY 4	CATEGORY 5
3101	Chair, 4 legs, seat height 44 cm or 46 cm, chromed or powder coated tubular steel base	5.279	5.759	6.159	8.399	9.999	13.599

**FRONT UPHOLSTERED - CLEAR LACQUERED VENEER**

MODEL	DESCRIPTION	CHRISTIANSHAVN	CATEGORY 1	CATEGORY 2	CATEGORY 3	CATEGORY 4	CATEGORY 5
3101	Chair, 4 legs, seat height 44 cm or 46 cm, chromed or powder coated tubular steel base	6.799	7.279	7.679	9.999	11.599	14.799

CATEGORY 1: BELFAST, CANVAS, CAPTURE, DIABLO, FAME, REMIX, TONUS  
CATEGORY 2: DIVINA, DIVINA MELANGE, DIVINA MD, FIORD, HALLINGDAL, RE-WOOL, STEELCUT, STEELCUT TRIO, SUNNIVA, VANIR, VIDAR  
CATEGORY 3: COMFORT, ESSENTIAL  
CATEGORY 4: Soft  
CATEGORY 5: Grace, Embrace, Natural  
SELECTED TEXTILE COLOURS - SEE THE SURFACE SELECTION  
BELFAST (770593, 770660, 771772, 772062, 772143, 772150, 772255, 774232, 774926, 775139)  
VANIR (193, 243, 373,393, 413, 443, 473, 693, 733, 773, 913, 983)

DESCRIPTION	PRICE
Linking device for 3101	767
Felt glides (3 or 4 pcs.)	79
Small transport dolly for 8 chairs (3100) or 12 chairs (3101)	4.639
Large transport dolly for 40 chairs	8.799
Chair rack, mounted under a table top	687

**3100      3101      SMALL AND LARGE TRANSPORT DOLLY FOR STACKABLE CHAIRS**

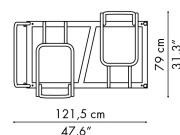
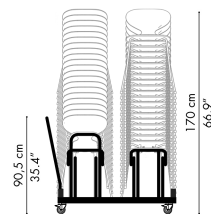
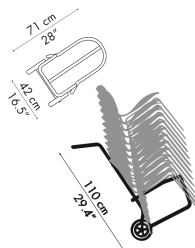
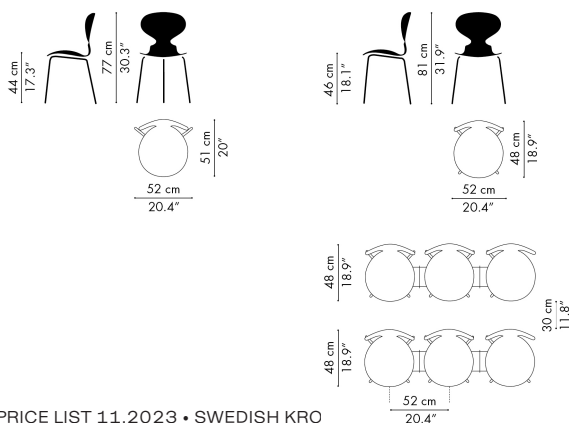



**SERIES 7™**  
**ARNE JACOBSEN 1955**

**11.2023**

The Series 7™ chair comes in three different finishes: Clear lacquered, coloured ash or lacquered veneer. All chairs are made of pressure moulded veneer. The shell is also available in front or fully upholstered versions in a wide range of textiles and leather types. Besides a base with four legs made of tubular steel, it also comes with a height-adjustable swivel base and castors, a counter or a bar stool. The bases of the Series 7™ are available with either a chromed or powder coated finish.

MODEL	DESCRIPTION	COLOURED ASH VENEER	LACQUERED VENEER	CLEAR LACQUERED VENEER
3107	Chair, stackable (max 12 pcs.), seat height 43 cm, 46 cm or 48 cm, chromed or powder coated tubular steel base	4.799	4.959	5.839
3207	Armchair, seat height 43 cm or 46 cm, chromed or powder coated tubular steel base	7.999	9.199	9.999
3187	Counter stool, seat height 64 cm, chromed or powder coated tubular steel base	6.799	6.959	7.759
3197	Bar stool, seat height 76 cm, chromed or powder coated tubular steel base	6.799	6.959	7.759
3117	Swivel chair, adjustable seat height 44-56 cm, 5 castors, chromed or powder coated tubular steel base	10.399	11.199	11.999
3217	Swivel armchair, adjustable seat height 44-56 cm, 5 castors, chromed or powder coated tubular steel base	13.599	14.799	15.599

**COLOURED ASH AND LACQUERED VENEER - SEE THE SURFACE SELECTION**

PALE ROSE (610/615), WILD ROSE (630/635), VENETIAN RED (670/675), PARADISE ORANGE (570/575), BURNT YELLOW (470/475), TRUE YELLOW (460/465), LIGHT BEIGE (130/135), DEEP CLAY (140/145), OLIVE GREEN (920/925), LAVENDER BLUE (810/815), DUSK BLUE (850/855), MIDNIGHT BLUE (890/895), EVERGREEN (950/955), BLACK (190/195), NINE GREY (150/155), WHITE (100/105)

**CLEAR LACQUERED VENEER - SEE THE SURFACE SELECTION**

MAPLE, BEECH, ASH, CHERRY, OREGON PINE, ELM, OAK, WALNUT, OAK - DARK STAINED, OAK - FULL DARK STAINED

**BASE COLOURS**

SILVER GREY, WARM GRAPHITE, BROWN BRONZE, BLACK, WHITE (ONLY WITH WHITE SHELL), NINE GREY, CHROME

**FRONT UPHOLSTERED - COLOURED ASH VENEER**

MODEL	DESCRIPTION	CHRISTIANSHAVN	CATEGORY 1	CATEGORY 2	CATEGORY 3	CATEGORY 4	CATEGORY 5
3107	Chair, seat height 43 cm, 46 cm or 48 cm, chromed or powder coated tubular steel base	6.639	7.119	7.519	9.599	11.599	14.799
3207	Armchair, seat height 43 cm or 46 cm, chromed or powder coated tubular steel base	9.999	10.399	10.799	12.799	14.799	17.999
3187	Counter stool, seat height 64 cm, chromed or powder coated tubular steel base	8.799	9.199	9.599	11.599	13.599	16.799
3197	Bar stool, seat height 76 cm, chromed or powder coated tubular steel base	8.799	9.199	9.599	11.599	13.599	16.799
3117	Swivel chair, adjustable seat height 44-56 cm, 5 castors, chromed or powder coated tubular steel base	12.399	12.799	13.199	15.599	17.199	20.399
3217	Swivel armchair, adjustable seat height 44-56 cm, 5 castors, chromed or powder coated tubular steel base	15.599	15.999	16.399	18.399	20.399	23.599

**FRONT UPHOLSTERED - LACQUERED VENEER**

MODEL	DESCRIPTION	CHRISTIANSHAVN	CATEGORY 1	CATEGORY 2	CATEGORY 3	CATEGORY 4	CATEGORY 5
3107	Chair, seat height 43 cm, 46 cm or 48 cm, chromed or powder coated tubular steel base	6.799	7.279	7.679	9.999	11.599	14.799
3207	Armchair, seat height 43 cm or 46 cm, chromed or powder coated tubular steel base	10.799	11.599	11.999	13.999	15.599	19.199
3187	Counter stool, seat height 64 cm, chromed or powder coated tubular steel base	8.799	9.599	9.999	11.999	13.599	16.799
3197	Bar stool, seat height 76 cm, chromed or powder coated tubular steel base	8.799	9.599	9.999	11.999	13.599	16.799
3117	Swivel chair, adjustable seat height 44-56 cm, 5 castors, chromed or powder coated tubular steel base	12.799	13.599	13.999	15.999	17.599	21.199
3217	Swivel armchair, adjustable seat height 44-56 cm, 5 castors, chromed or powder coated tubular steel base	16.799	17.199	17.599	19.599	21.199	24.799

**FRONT UPHOLSTERED - CLEAR LACQUERED VENEER**

MODEL	DESCRIPTION	CHRISTIANSHAVN	CATEGORY 1	CATEGORY 2	CATEGORY 3	CATEGORY 4	CATEGORY 5
3107	Chair, seat height 43 cm, 46 cm or 48 cm, chromed or powder coated tubular steel base	7.599	8.399	8.799	10.799	12.399	15.999
3207	Armchair, seat height 43 cm or 46 cm, chromed or powder coated tubular steel base	11.599	12.399	12.799	14.799	16.399	19.999
3187	Counter stool, seat height 64 cm, chromed or powder coated tubular steel base	9.599	10.399	10.799	12.799	14.399	17.999
3197	Bar stool, seat height 76 cm, chromed or powder coated tubular steel base	9.599	10.399	10.799	12.799	14.399	17.999
3117	Swivel chair, adjustable seat height 44-56 cm, 5 castors, chromed or powder coated tubular steel base	13.599	14.399	14.799	16.799	18.399	21.999
3217	Swivel armchair, adjustable seat height 44-56 cm, 5 castors, chromed or powder coated tubular steel base	17.599	17.999	18.399	20.399	22.399	25.599

**CATEGORY 1: BELFAST, CANVAS, CAPTURE, DIABLO, FAME, REMIX, TONUS**

**CATEGORY 2: DIVINA, DIVINA MELANGE, DIVINA MD, FIORD, HALLINGDAL, RE-WOOL, STEELCUT, STEELCUT TRIO, SUNNIVA, VANIR**

**CATEGORY 3: COMFORT, ESSENTIAL**

**CATEGORY 4: SOFT**

**CATEGORY 5: GRACE, EMBRACE, NATURAL**

**SELECTED TEXTILE COLOURS - SEE THE SURFACE SELECTION**

BELFAST (770593, 770660, 771772, 772062, 772143, 772150, 772255, 774232, 774926, 775139)  
VANIR (193, 243, 373, 393, 413, 443, 473, 693, 733, 773, 913, 983)



FULLY UPHOLSTERED

MODEL	DESCRIPTION	CHRISTIANSHAVN	CATEGORY 1	CATEGORY 2	CATEGORY 3	CATEGORY 4	CATEGORY 5
3107	Chair, seat height 43 cm, 46 cm or 48 cm, chromed or powder coated tubular steel base	7.599	7.999	8.399	11.599	13.999	19.199
3207	Armchair, seat height 43 cm or 46 cm, chromed or powder coated tubular steel base	10.399	10.799	11.599	14.399	16.799	21.199
3187	Counter stool, seat height 64 cm, chromed or powder coated tubular steel base	10.399	10.799	11.199	13.999	16.399	19.599
3197	Bar stool, seat height 76 cm, chromed or powder coated tubular steel base	10.399	10.799	11.199	13.999	16.399	19.599
3117	Swivel chair, adjustable seat height 44-56 cm, 5 castors, chromed or powder coated tubular steel base	12.799	13.199	13.999	16.399	19.199	22.399
3217	Swivel armchair, adjustable seat height 44-56 cm, 5 castors, chromed or powder coated tubular steel base	15.999	16.799	17.999	20.399	23.199	26.799

CATEGORY 1: BELFAST, CANVAS, CAPTURE, DIABLO, FAME, REMIX, TONUS

CATEGORY 2: DIVINA, DIVINA MELANGE, DIVINA MD, FIORD, HALLINGDAL, RE-WOOL, STEELCUT, STEELCUT TRIO, SUNNIVA, VANIR

CATEGORY 3: COMFORT, ESSENTIAL

CATEGORY 4: SOFT

CATEGORY 5: GRACE, EMBRACE, RUSTIK, NATURAL

SELECTED TEXTILE COLOURS - SEE THE SURFACE SELECTION

BELFAST (770593, 770660, 771772, 772062, 772143, 772150, 772255, 774232, 774926, 775139)

VANIR (193, 243, 373, 393, 413, 443, 473, 693, 733, 773, 913, 983)

OPTIONS

DESCRIPTION	PRICE
Hard castors for soft floors with or without brake	No surcharge
Soft castor for hard floors with or without brake	No surcharge
Linking device for 3107, short	767
Linking device for 3107 w/writing tablet and 3207, long	767
Writing tablet for 3107, fold-away, white laminated surface, chromed arm	3.519
Writing tablet for 3107, coloured veneer: black, chromed arm, Made to order (MOQ: 25 pcs)	3.519
Small transport dolly for 12 pcs. 3107 chairs, non-upholstered	4.639
Large transport dolly for 40 pcs. 3107 chairs, non-upholstered	8.799
Felt glides (4 pcs.)	79
Chair rack for 3107 chairs, mounted under a table top, for non-upholstered chairs only	687
3107SC Seat cushion, Wild leather, walnut (colli 4 pcs)	1.119
3107SC Seat cushion, Raw leather, black (colli 4 pcs)	783
3107SC Seat cushion, Intense leather, brown (colli 4 pcs.)	783



3107

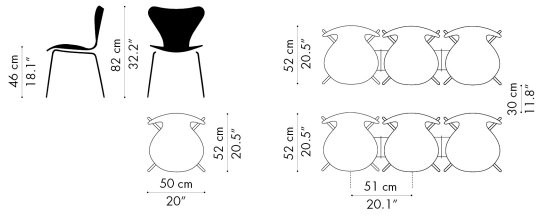

3107 WITH WRITING TABLET

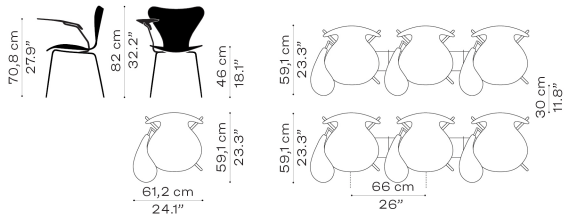

3207

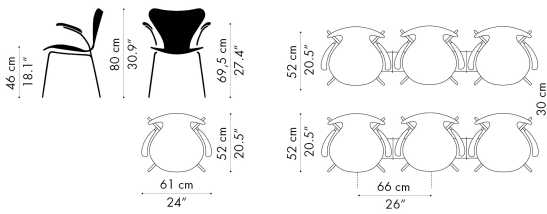

3117

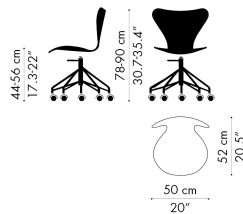

3217

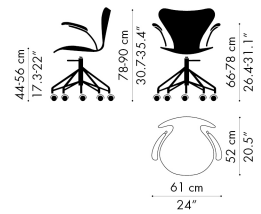

3187

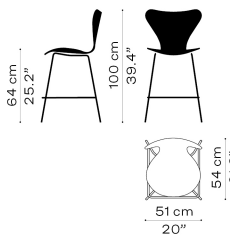

3197

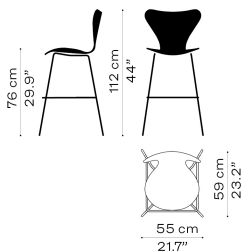

SMALL AND LARGE TRANSPORT DOLLY FOR STACKABLE CHAIRS

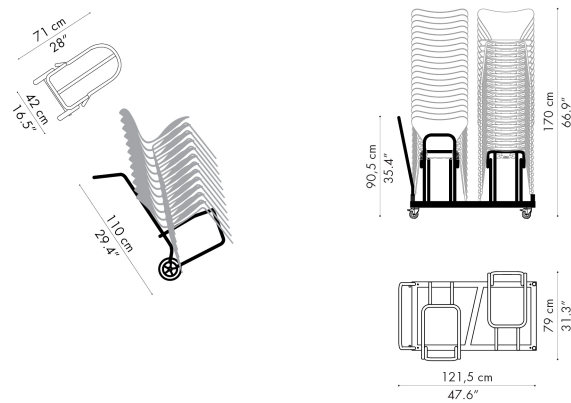



## CHILDREN'S CHAIRS / JUNIOR ARNE JACOBSEN 2005/2019

11.2023

The Children's Chairs are available in three variants: Coloured ash veneer (Wild Rose and Midnight Blue) and clear lacquered Oregon Pine. The base comes with 4 legs (stackable) and is made of chromed steel tubes. The Junior chair is available in clear lacquered oak veneer or black coloured ash veneer with a chromed steel base, coloured ash veneer in Evergreen or Burned Yellow with a Brown Bronze base.

### CHILDREN'S CHAIRS / JUNIOR

MODEL	DESCRIPTION	PRICE
840224	Ant™ Children's Chair, stackable (max 10 pcs.), seat height 34 cm, Midnight Blue (895), chromed tubular steel base - colli 1 (2 pcs)	3.039
840225	Ant™ Children's Chair, stackable (max 10 pcs.), seat height 34 cm, Wild Rose (635), chromed tubular steel base - colli 1 (2 pcs)	3.039
840226	Ant™ Children's Chair, stackable (max 10 pcs.), seat height 34 cm, Oregon Pine, chromed tubular steel base - colli 1 (2 pcs)	3.039
840221	Grand Prix™ Children's Chair, stackable (max 10 pcs.), seat height 34 cm, Midnight Blue (895), chromed tubular steel base - colli 1 (2 pcs)	3.039
840222	Grand Prix™ Children's Chair, stackable (max 10 pcs.), seat height 34 cm, Wild Rose (635), chromed tubular steel base - colli 1 (2 pcs)	3.039
840223	Grand Prix™ Children's Chair, stackable (max 10 pcs.), seat height 34 cm, Oregon Pine, chromed tubular steel base - colli 1 (2 pcs)	3.039
840243	Lily™ Children's Chair, stackable (max 10 pcs.), seat height 34 cm, Midnight Blue (895), chromed tubular steel base - colli 1 (2 pcs)	3.039
840242	Lily™ Children's Chair, stackable (max 10 pcs.), seat height 34 cm, Wild Rose (635), chromed tubular steel base - colli 1 (2 pcs)	3.039
840241	Lily™ Children's Chair, stackable (max 10 pcs.), seat height 34 cm, Oregon Pine, chromed tubular steel base - colli 1 (2 pcs)	3.039
840227	Series 7™ Children's Chair, stackable (max 10 pcs.), seat height 34 cm, Midnight Blue (895), chromed tubular steel base - colli 1 (2 pcs)	3.039
840228	Series 7™ Children's Chair, stackable (max 10 pcs.), seat height 34 cm, Wild Rose (635), chromed tubular steel base - colli 1 (2 pcs)	3.039
840229	Series 7™ Children's Chair, stackable (max 10 pcs.), seat height 34 cm, Oregon Pine, chromed tubular steel base - colli 1 (2 pcs)	3.039
840236	Junior chair, seat height 52 cm, Black, chromed tubular steel base	3.679
840237	Junior chair, seat height 52 cm, Oak veneer, chromed tubular steel base	3.679
840238	Junior chair, seat height 52, Burnt Yellow, Brown Bronze powder coated tubular steel base	3.679
840239	Junior chair, seat height 52, Evergreen, Brown Bronze powder coated tubular steel base	3.679

#### ANT™ CHILDREN'S CHAIR

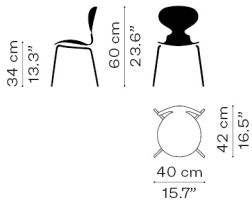

#### GRAND PRIX™ CHILDREN'S CHAIR

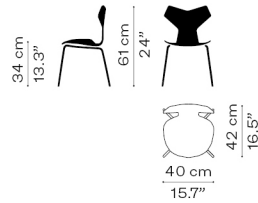

#### LILY™ CHILDREN'S CHAIR

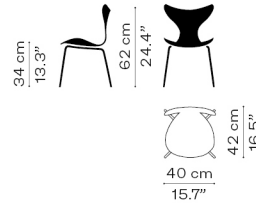

#### SERIES 7™ CHILDREN'S CHAIR

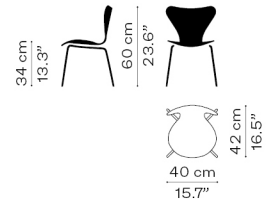

#### SERIES 7™ JUNIOR

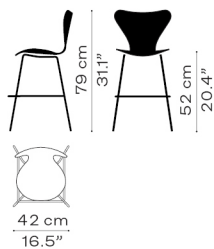





**DOT™ / HIGH DOT™**  
ARNE JACOBSEN 1954

11.2023

The Dot™ and the High Dot™ stools are available in selected leather and veneer variants: Black coloured ash or clear lacquered walnut. All stools come with four legs, while the High Dot™ Counter also comes with a three-legged base. The bases are made of chromed or powder coated tubular steel.

**DOT™, 46CM**

MODEL	DESCRIPTION	PRICE
840128	4 legs, black coloured ash (195), chromed tubular steel base	2.639
840132	4 legs, Walnut veneer, chromed tubular steel base	2.639
840105	4 legs, Intense matt black leather, black powder coated tubular steel base	3.119
840100	4 legs, Wild Walnut leather, chromed tubular steel base	3.119

**HIGH DOT™ COUNTER, 65 CM**

MODEL	DESCRIPTION	PRICE
840130	4 legs, black coloured ash (195), chromed tubular steel base	3.599
840134	4 legs, Walnut veneer, chromed tubular steel base	3.599
840136	4 legs, Intense Matt black leather, black powder coated tubular steel base	3.999
840138	4 legs, Wild Walnut leather, chromed tubular steel base	3.999

**HIGH DOT™ BAR, 76 CM**

MODEL	DESCRIPTION	PRICE
840131	4 legs, black coloured ash (195), chromed tubular steel base	3.599
840135	4 legs, Walnut veneer, chromed tubular steel base	3.599
840137	4 legs, Intense Matt black leather, black powder coated tubular steel base	3.999
840139	4 legs, Wild leather Walnut, chromed tubular steel base	3.999

**HIGH DOT™ COUNTER**

**HIGH DOT™ BAR**

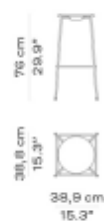
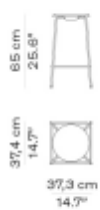



**GRAND PRIX™**  
**ARNE JACOBSEN 1957**

**11.2023**

The Grand Prix™ comes in clear lacquered (oak or walnut), coloured ash or lacquered (only 3130) veneer. All chairs are made of pressure moulded veneer. Front upholstery or full upholstery is available in a wide range of textiles and leather types. The base comes with four legs in several variants: Chromed or powder coated tubular steel (stackable max 5 pcs.) and wooden legs (non-stackable). Besides a base with four legs made of tubular steel, it also comes with a height-adjustable swivel base and castors, a counter or a bar stool.

MODEL	DESCRIPTION	COLOURED ASH VENEER	LACQUERED VENEER	CLEAR LACQUERED VENEER
3130	Chair, stackable (max 5 pcs.), seat height 43 cm, 46 cm or 48 cm, chromed or powder coated tubular steel base	4.799	4.959	5.839
4130	Chair, seat height 43 cm or 46 cm, wooden legs	6.639		6.879
3138	Counter stool, seat height 64 cm, chromed or powder coated tubular steel base	6.479	6.639	7.439
3139	Bar stool, seat height 76 cm, chromed or powder coated tubular steel base	6.479	6.639	7.439
3131	Swivel chair, adjustable seat height 44-56 cm, 5 castors, chromed or powder coated tubular steel base	9.999	10.399	11.199

**COLOURED ASH AND LACQUERED VENEER - SEE THE SURFACE SELECTION**

PALE ROSE (610/615), WILD ROSE (630/635), VENETIAN RED (670/675), PARADISE ORANGE (570/575), BURNT YELLOW (470/475), TRUE YELLOW (460/465), LIGHT BEIGE (130/135), DEEP CLAY (140/145), OLIVE GREEN (920/925), LAVENDER BLUE (810/815), DUSK BLUE (850/855), MIDNIGHT BLUE (890/895), EVERGREEN (950/955), BLACK (190/195), NINE GREY (150/155), WHITE (100/105)

CLEAR LACQUERED VENEER - SEE THE SURFACE SELECTION  
OAK, WALNUT

**BASE COLOURS**

3130, 3131, 3138, 3139: SILVER GREY, WARM GRAPHITE, BROWN BRONZE, BLACK, WHITE (ONLY WITH WHITE SHELL), NINE GREY, CHROME  
4130: OAK, WALNUT, BLACK, NINE GREY, WHITE (ONLY WITH WHITE SHELL)

[\*OAK/WALNUT VENEER SHELLS ARE ONLY AVAILABLE WITH MATCHING WOODEN BASE]

**FRONT UPHOLSTERED - COLOURED ASH VENEER**

MODEL	DESCRIPTION	CHRISTIANSHAVN	CATEGORY 1	CATEGORY 2	CATEGORY 3	CATEGORY 4	CATEGORY 5
3130	Chair, stackable (max 5 pcs.), seat height 43 cm, 46 cm or 48 cm, chromed or powder coated tubular steel base	6.639	7.119	7.519	9.599	11.599	14.799
4130	Chair, seat height 43 cm or 46 cm, wooden legs	8.399	9.199	9.599	11.599	13.199	16.799
3138	Counter stool, seat height 64 cm, chromed or powder coated tubular steel base	8.399	8.799	9.199	11.199	12.799	15.999
3139	Bar stool, seat height 76 cm, chromed or powder coated tubular steel base	8.399	8.799	9.199	11.199	12.799	15.999
3131	Swivel chair, adjustable seat height 44-56 cm, 5 castors, chromed or powder coated tubular steel base	11.999	12.399	12.799	14.799	16.399	19.599

**FRONT UPHOLSTERED - LACQUERED VENEER**

MODEL	DESCRIPTION	CHRISTIANSHAVN	CATEGORY 1	CATEGORY 2	CATEGORY 3	CATEGORY 4	CATEGORY 5
3130	Chair, stackable (max 5 pcs.), seat height 43 cm, 46 cm or 48 cm, chromed or powder coated tubular steel base	6.799	7.279	7.679	9.999	11.599	14.799
3138	Counter stool, seat height 64 cm, chromed or powder coated tubular steel base	8.399	8.799	9.199	11.199	12.799	15.999
3139	Bar stool, seat height 76 cm, chromed or powder coated tubular steel base	8.399	8.799	9.199	11.199	12.799	15.999
3131	Swivel chair, adjustable seat height 44-56 cm, 5 castors, chromed or powder coated tubular steel base	12.399	12.799	13.199	15.199	16.799	19.999

**FRONT UPHOLSTERED - CLEAR LACQUERED VENEER**

MODEL	DESCRIPTION	CHRISTIANSHAVN	CATEGORY 1	CATEGORY 2	CATEGORY 3	CATEGORY 4	CATEGORY 5
3130	Chair, stackable (max 5 pcs.), seat height 43 cm, 46 cm or 48 cm, chromed or powder coated tubular steel base	7.599	8.399	8.799	10.799	12.399	15.999
4130	Chair, seat height 43 cm or 46 cm, wooden legs	8.799	9.199	9.599	11.999	13.599	16.799
3138	Counter stool, seat height 64 cm, chromed or powder coated tubular steel base	9.199	9.599	9.999	11.999	13.599	16.799
3139	Bar stool, seat height 76 cm, chromed or powder coated tubular steel base	9.199	9.599	9.999	11.999	13.599	16.799
3131	Swivel chair, adjustable seat height 44-56 cm, 5 castors, chromed or powder coated tubular steel base	13.199	13.599	13.999	15.999	17.599	20.799

**CATEGORY 1: CANVAS, CAPTURE, DIABLO, FAME, REMIX, TONUS**

**CATEGORY 2: DIVINA, DIVINA MELANGE, DIVINA MD, FIORD, HALLINGDAL, RE-WOOL, STEELCUT, STEELCUT TRIO, SUNNIVA, VANIR**

**CATEGORY 3: COMFORT, ESSENTIAL**

**CATEGORY 4: SOFT**

**CATEGORY 5: GRACE, EMBRACE, NATURAL**

**SELECTED TEXTILE COLOURS - SEE THE SURFACE SELECTION**

VANIR (193, 243, 373, 393, 413, 443, 473, 693, 733, 773, 913, 983)



FULLY UPHOLSTERED

MODEL	DESCRIPTION	CHRISTIANSHAVN	CATEGORY 1	CATEGORY 2	CATEGORY 3	CATEGORY 4	CATEGORY 5
3130	Chair, seat height 43 cm, 46 or 48 cm, chromed or powder coated tubular steel base	7.599	7.999	8.399	11.599	13.999	19.199
4130	Chair, seat height 43 cm or 46 cm, wooden legs	9.599	9.999	10.399	13.199	15.999	21.199
3138	Counter stool, seat height 64 cm, chromed or powder coated tubular steel base	9.599	10.399	10.799	13.599	15.599	18.799
3139	Bar stool, seat height 76 cm, chromed or powder coated tubular steel base	9.599	10.399	10.799	13.599	15.599	18.799
3131	Swivel chair, adjustable seat height 44-56 cm, 5 castors, chromed or powder coated tubular steel base	11.999	12.799	13.199	15.599	17.999	21.199

CATEGORY 1: CANVAS, CAPTURE, DIABLO, FAME, REMIX, TONUS  
 CATEGORY 2: DIVINA, DIVINA MELANGE, DIVINA MD, FIORD, HALLINGDAL, RE-WOOL, STEELCUT, STEELCUT TRIO, SUNNIVA, VANIR  
 CATEGORY 3: COMFORT, ESSENTIAL  
 CATEGORY 4: SOFT  
 CATEGORY 5: GRACE, EMBRACE, RUSTIK, NATURAL

SELECTED TEXTILE COLOURS - SEE THE SURFACE SELECTION  
 VANIR (193, 243, 373,393, 413, 443, 473, 693, 733, 773, 913, 983)

OPTIONS

DESCRIPTION	PRICE
Hard castors for soft floors with or without brake	No surcharge
Soft castor for hard floors with or without brake	No surcharge
Linking device for 3130 chairs	767
Small transport dolly for 5 pcs. 3130 chairs, non-upholstered	4.639
Chair rack for 3130 chairs, mounted under a table top, for non-upholstered chairs only	687
Felt glides (4 pcs.)	79



3130

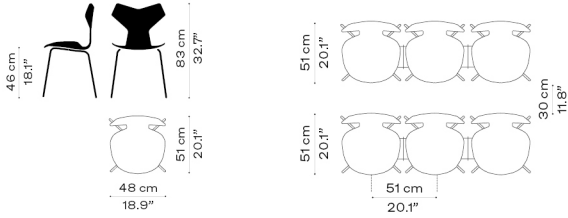

4130

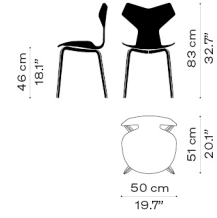

3131

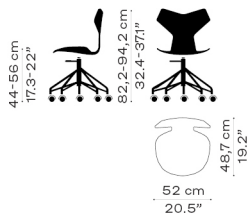

3138

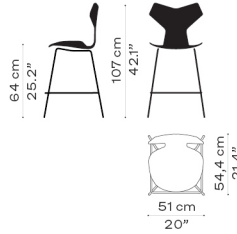

3139

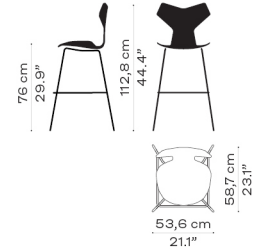

SMALL TRANSPORT DOLLY FOR STACKABLE CHAIRS

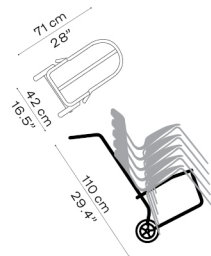



The Lily™ chair comes in two variants; with or without arms, in clear lacquered walnut veneer or fully upholstered in a wide range of textiles and leather types. All chairs are made of pressure moulded veneer. The base comes with four legs made of chromed tubular steel.

MODEL	DESCRIPTION	CLEAR LACQUERED WALNUT
3108	Chair, stackable, seat height 43 cm or 46 cm, chromed tubular steel base	7.359
3208	Armchair, seat height 43 cm or 46 cm, chromed tubular steel base	13.199

FULLY UPHOLSTERED

MODEL	DESCRIPTION	CHRISTIANSHAVN	CATEGORY 1	CATEGORY 2	CATEGORY 3	CATEGORY 4	CATEGORY 5
3108	Chair, stackable, seat height 43 cm or 46 cm, chromed tubular steel base	12.399	13.199	13.199	18.399	22.399	31.199
3208	Armchair, seat height 43 cm or 46 cm, chromed tubular steel base	25.999	27.599	27.599	30.799	35.599	44.799

CATEGORY 1: CANVAS, CAPTURE, DIABLO, FAME, REMIX, TONUS  
 CATEGORY 2: DIVINA, DIVINA MELANGE, DIVINA MD, FIORD, HALLINGDAL, RE-WOOL, STEELCUT, STEELCUT TRIO, SUNNIVA, VANIR  
 CATEGORY 3: COMFORT, ESSENTIAL  
 CATEGORY 4: SOFT  
 CATEGORY 5: GRACE, EMBRACE, RUSTIK, NATURAL

SELECTED TEXTILE COLOURS - SEE THE SURFACE SELECTION  
 VANIR (193, 243, 373,393, 413, 443, 473, 693, 733, 773, 913, 983)

OPTIONS

DESCRIPTION	PRICE
Felt glides (4 pcs.)	79
Linking device for 3108	767
Small transport dolly for 8 pcs. 3108 chairs, non-upholstered	4.639
Chair rack for 3108 chairs, mounted under a table top, for non-upholstered chairs only	687

3108

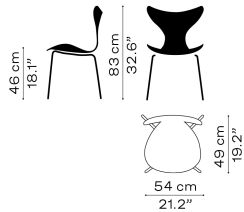

3208

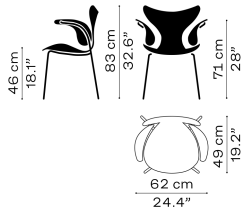

SMALL TRANSPORT DOLLY

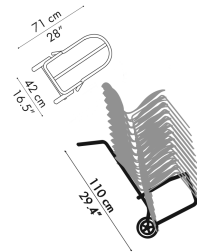



**DROP™**  
ARNE JACOBSEN 1958/2014

11.2023

The Drop™ chair comes with a shell made of ABS plastic and four legs in chromed or powder coated tubular steel. The chair is also available upholstered in a wide range of textile and leather types.

**PLASTIC**

MODEL	DESCRIPTION	PLASTIC (ABS)
3110	Chair, 43 cm or 46 cm, chromed or powder coated tubular steel base	3.439

PLASTIC COLOURS - SEE THE SURFACE SELECTION  
DEEP CLAY, LIGHT BEIGE, PALE ROSE, OLIVE GREEN, BLACK, WHITE

BASE COLOURS  
WARM GRAPHITE, BROWN BRONZE, BLACK, WHITE (ONLY WITH WHITE SHELL), CHROME

**FULLY UPHOLSTERED**

MODEL	DESCRIPTION	CHRISTIANSHAVN	CATEGORY 1	CATEGORY 2	CATEGORY 3	CATEGORY 4	CATEGORY 5
3110	Chair, 43 cm or 46 cm, handstitched, chromed or powder coated tubular steel base	10.399	11.199	11.999	18.399	19.999	23.599
3110UB	Chair, 43 cm or 46 cm, Essential leather with front stitching and piping, chrome or powder coated tubular steel base				11.599		

CATEGORY 1: CANVAS, CAPTURE, DIABLO, FAME, REMIX, TONUS  
CATEGORY 2: DIVINA, DIVINA MELANGE, DIVINA MD, FIORD, HALLINGDAL, RE-WOOL, STEELCUT, STEELCUT TRIO, SUNNIVA  
CATEGORY 3: COMFORT, ESSENTIAL  
CATEGORY 4: AURA  
CATEGORY 5: GRACE, EMBRACE, RUSTIK, NATURAL

**OPTIONS**

DESCRIPTION	PRICE
Felt glides (4 pcs.)	95
3110SC Seat cushion, Salsa 3 textile, grey (36)	623
3110SC Seat cushion, Salsa 3 textile, black (39)	623

3110/3110UB

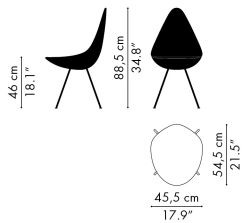



**LITTLE GIRAFFE™**  
**ARNE JACOBSEN 1959/2018**

**11.2023**

The Little Giraffe™ chair is upholstered with either a fixed or a removable cover in a wide selection of textiles and leather types. Seat and backrest of the chair are made from PUR-foam moulded around an inner steel frame. Its base is available either with four tubular steel legs or a five-star base made of die-cast aluminium.

MODEL	DESCRIPTION	CHRISTIANSHAVN	CATEGORY 1	CATEGORY 2	CATEGORY 3	CATEGORY 4	CATEGORY 5
3201	Chair, fixed cover, 4 legs, chromed or black powder coated tubular steel base	12.399	12.799	14.799	21.599	26.399	31.599
3201R	Chair, removable cover, 4 legs, chromed or black powder coated tubular steel base	13.599	13.999	15.999			
3211	Swivel chair, fixed cover, height-adjustable, satin brushed or black powder coated aluminium base, 5 castors	14.799	15.599	17.199	23.999	29.199	34.399
3211R	Swivel chair, removable cover, height-adjustable, satin brushed or black powder coated aluminium base, 5 castors	15.999	16.799	18.799			
32C	Removable cover, in textile only	3.599	3.759	4.319			

CATEGORY 1: CANVAS, CAPTURE, DIABLO, FAME, REMIX, TONUS  
 CATEGORY 2: DIVINA, DIVINA MELANGE, DIVINA MD, FIORD, HALLINGDAL, RE-WOOL, STEELCUT, STEELCUT TRIO, SUNNIVA  
 CATEGORY 3: COMFORT (3201 & 3211), ESSENTIAL  
 CATEGORY 4: AURA  
 CATEGORY 5: GRACE, EMBRACE, RUSTIK, NATURAL

**BASE COLOURS**  
 3201, 3201R: BLACK, CHROME  
 3211, 3211R: BLACK, BRUSHED ALUMINIUM

**OPTIONS**

DESCRIPTION	PRICE
Hard castors for soft floors with or without brake	No surcharge
Soft castor for hard floors with or without brake	No surcharge

**3201**

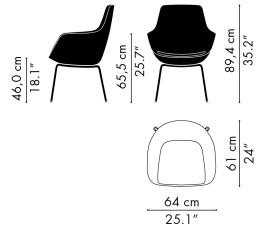

**3211**

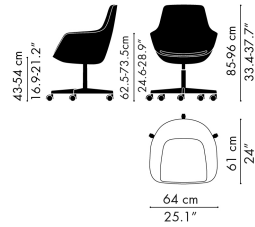



**OXFORD™**  
**ARNE JACOBSEN 1965**

11.2023

The Oxford™ chair comes fully upholstered in a wide range of textile or leather types and is available with a low or medium back, with or without armrests. The inner shell of the chair is made of a pressure moulded veneer shell covered with cut HR foam. The base of the chair is made of die-cast aluminium and available either as a fixed four-star or five-star base with or without castors, either fixed or height adjustable with tilt mechanism. The bases come in two finishes; satin brushed or powder coated aluminium, while the five-star base is also optionally available in mirror chrome. Optional comfort-enhancing arm pads are available for armrest configurations.

**4-STAR BASE**

MODEL	DESCRIPTION	CHRISTIANSHAVN	CATEGORY 1	CATEGORY 2	CATEGORY 3	CATEGORY 4	CATEGORY 5
3141T	Chair, low back, fixed seat height, toes	20.399	21.599	22.799	25.999	29.599	40.799
3143T	Chair, medium back, fixed seat height, toes	22.799	23.999	25.199	28.799	32.799	44.799
3241T	Armchair, low back, fixed seat height, toes	22.799	23.999	25.199	28.399	32.799	43.199
3243T	Armchair, medium back, fixed seat height, toes	25.199	26.399	27.999	31.199	35.199	47.199

**5-STAR BASE**

MODEL	DESCRIPTION	CHRISTIANSHAVN	CATEGORY 1	CATEGORY 2	CATEGORY 3	CATEGORY 4	CATEGORY 5
3171T	Chair, low back, fixed seat height, glides or toes	21.999	23.199	24.399	27.199	31.199	42.399
3173T	Chair, medium back, fixed height, glides or toes	24.399	25.599	26.799	30.399	34.399	45.999
3191T	Chair, low back, height adjustable, tilt, glides or toes	22.799	23.599	25.199	27.999	31.999	43.199
3193T	Chair, medium back, height adjustable, tilt, glides or toes	25.199	26.399	27.599	31.199	35.199	46.799
3271T	Armchair, low back, fixed seat height, glides or toes	24.399	25.599	26.799	29.599	33.599	44.799
3273T	Armchair, medium back, fixed seat height, glides or toes	26.799	27.999	29.199	32.799	36.799	48.799
3291T	Armchair, low back, height adjustable, tilt, glides or toes	25.199	26.399	27.599	30.399	34.399	45.599
3293T	Armchair, medium back, height adjustable, tilt, glides or toes	27.599	28.799	29.999	33.599	37.599	49.199

**5-STAR BASE WITH CASTORS**

MODEL	DESCRIPTION	CHRISTIANSHAVN	CATEGORY 1	CATEGORY 2	CATEGORY 3	CATEGORY 4	CATEGORY 5
3171W	Chair, low back, fixed seat height, castors	25.199	26.399	27.599	30.799	34.399	45.999
3173W	Chair, medium back, fixed seat height, castors	27.599	28.799	30.399	33.599	37.599	49.599
3191W	Chair, low back, height adjustable, tilt, castors	25.999	27.199	28.399	31.599	35.199	46.399
3193W	Chair, medium back, height adjustable, tilt, castors	28.399	29.599	30.799	34.399	38.399	50.399
3271W	Armchair, low back, fixed seat height, castors	27.599	28.799	29.999	33.199	36.799	48.399
3273W	Armchair, medium back, fixed seat height, castors	29.999	31.199	32.799	35.999	40.399	51.999
3291W	Armchair, low back, height adjustable, tilt, castors	28.399	29.599	30.799	33.999	37.599	48.799
3293W	Armchair, medium back, height adjustable, tilt, castors	30.799	31.999	33.199	36.799	40.799	52.799

CATEGORY 1: CANVAS, CAPTURE, DIABLO, FAME, REMIX, TONUS  
 CATEGORY 2: DIVINA, DIVINA MELANGE, DIVINA MD, FIORD, HALLINGDAL, STEELCUT, STEELCUT TRIO, SUNNIVA, RE-WOOL, VIDAR  
 CATEGORY 3: COMFORT, ESSENTIAL, SONAR  
 CATEGORY 4: SOFT  
 CATEGORY 5: GRACE, EMBRACE, RUSTIK, NATURAL

BASE COLOURS: WARM GRAPHITE, BROWN BRONZE, BLACK, SATIN BRUSHED ALUMINIUM

**OPTIONS**

DESCRIPTION	PRICE
Hard castors for soft floors with or without brake	No surcharge
Soft castor for hard floors with or without brake	No surcharge
Automatic return for chairs with fixed seat height	1.839
Arm pads in black plastic for chairs upholstered in textile	695
Arm pads in matching leather for chairs upholstered in leather	2.079
Mirror chromed base (5-star bases)	1.159
Mirror chromed base and armrests (5-star bases)	2.319





3141T

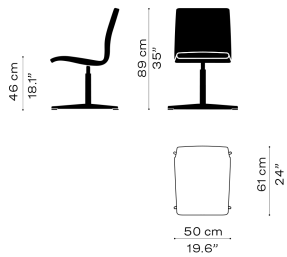

3143T

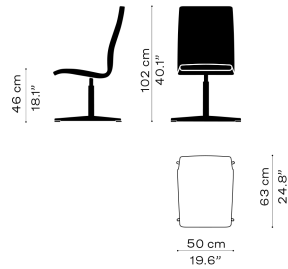

3241T

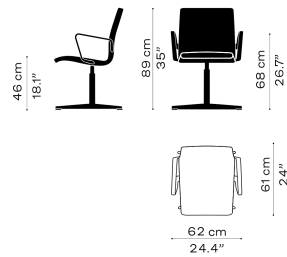

3243T

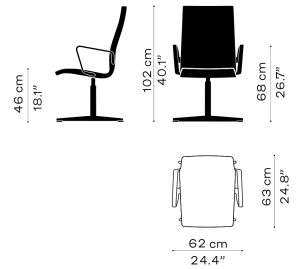

3171T

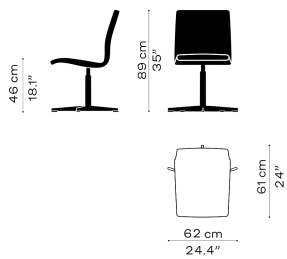

3173T

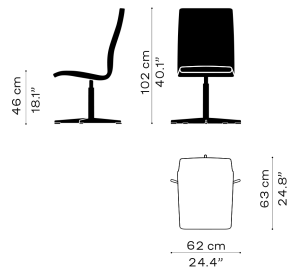

3191T

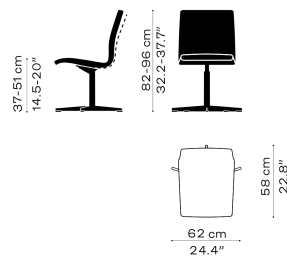

3193T

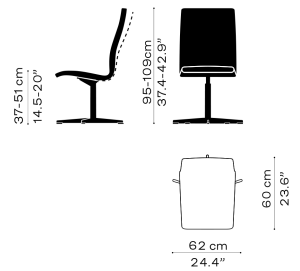

3271T

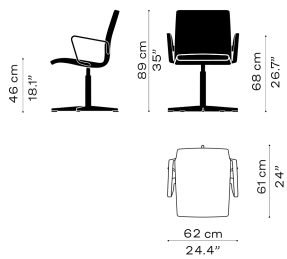

3273T

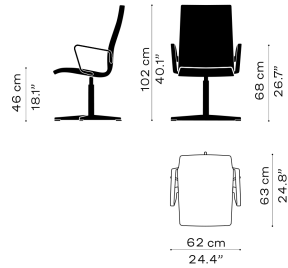

3291T

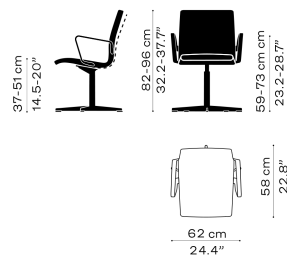

3293T

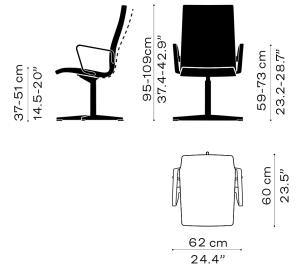

3171W

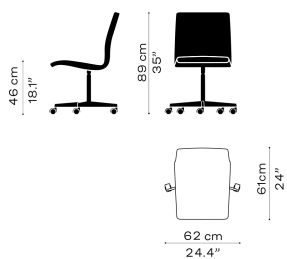

3173W

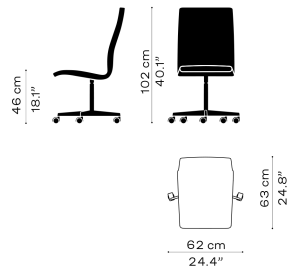

3191W

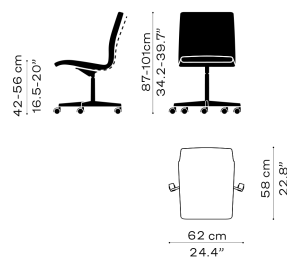

3193W

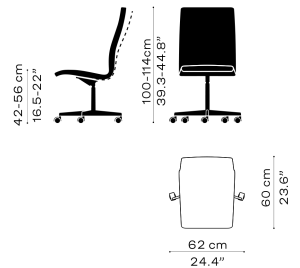

3271W

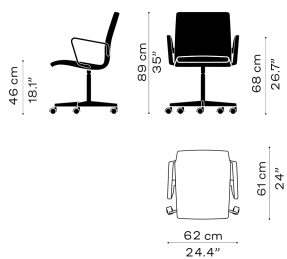

3273W

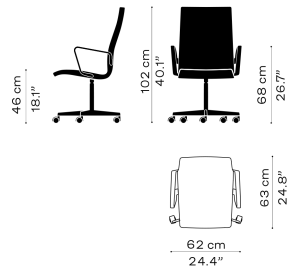

3291W

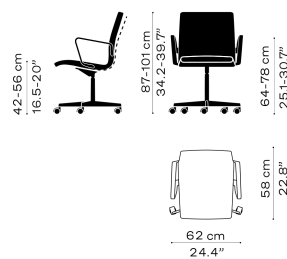

3293W

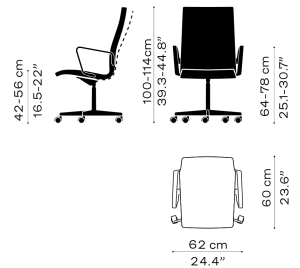



**N01™**  
**NENDO 2018**

**11.2023**

The N01™ armchair is made of a solid wood base with seat and backrest in pressure moulded veneer. The fully wooden chair is available in clear lacquered beech, clear lacquered oak and black coloured oak. Optionally, a seat cushion made of textile or leather is available, which can either be mounted with a Velcro fastener or purchased separately as a loose cushion.

MODEL	DESCRIPTION	CLEAR LACQUERED BEECH	BLACK COLOURED OAK	CLEAR LACQUERED OAK
N01	Armchair, seat height 44 cm or 46,5 cm, solid wood base	7.679	8.799	8.799

**OPTIONS**

DESCRIPTION	PRICE
Seat cushion (loose) in Remix textile dark blue/grey (173), beige (233) or dark brown (393)	879
Seat cushion (loose) in Raw leather, black	1.079
Seat cushion (fixed, incl. Velcro) in Remix textile dark blue/grey (173), beige (233) or dark brown (393)	1.199
Seat cushion (fixed, incl. Velcro), in Raw leather, black	1.559

**N01**

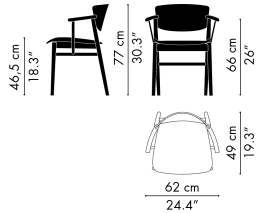



# NO2™ RECYCLE NENDO 2019

11.2023

NO2™ Recycle is made from recycled plastic (PP) from household waste. It is available in seven shell colours with four legs made of tubular steel, a sledge base made of solid steel or a die-cast aluminium swivel base. The NO2™ Recycle is also configurable as counter or bar stool with a four-legged base. The chair is available with an optional seat cushion in textile, mounted or sold separately.

MODEL	DESCRIPTION	RECYCLED PLASTIC (PP)	PRICE
N02-10	Chair, stackable (max 10 pcs.), seat height 46 cm, 4 legs, chromed or powder coated tubular steel		3.039
N02-11	Armchair, stackable (max 10 pcs.), seat height 46 cm, 4 legs, chromed or powder coated tubular steel		4.079
N02-20	Chair, stackable (max 10 pcs.), seat height 46 cm, chromed solid steel sledge base		3.039
N02-21	Chair w/welded linking device, stackable (max 10 pcs.), seat height 46 cm, chromed steel sledge base		3.599
N02-30	Swivel chair, polished aluminium base, 5 castors		5.439
N02-31	Swivel armchair, polished aluminium base, 5 castors		6.479
N02-40	Counter stool, stackable (max 4 pcs.), seat height 64 cm, chromed or powder coated tubular steel base		3.679
N02-50	Bar stool, stackable (max 4 pcs.), seat height 76 cm, chromed or powder coated tubular steel base		4.319

**SHELL AND BASE COLOURS**  
OFF WHITE, GREY, BLACK, DARK ORANGE, DARK RED, LIGHT BLUE, DARK BLUE

## OPTIONS

DESCRIPTION	PRICE
Hard castors for soft floors with or without brake	No surcharge
Soft castor for hard floors with or without brake	No surcharge
N02-70 Seat cushion, Just textile in black (60999), dark grey (60121) or light grey (60118)	671
Linking device for N02-20	359
Felt glides (4 pcs.)	95
Small transport dolly for 10 pcs. N02-10, N02-11 or N02-20 chairs	4.639
Chair rack for N02 chairs, mounted under a table top	687

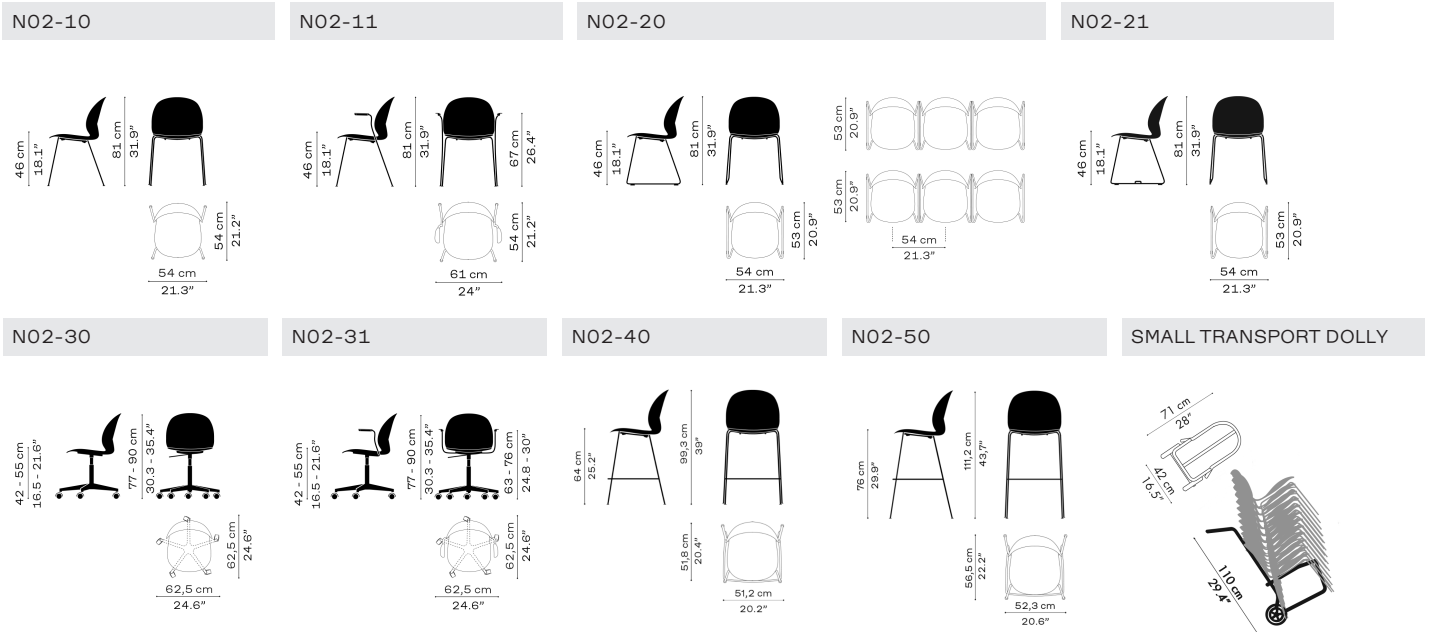

**CERTIFICATION**  
 The NO2™ Recycle models N02-10 and N02-11 with powder coated legs have achieved the EU-Ecolabel.

**EU Ecolabel**  
[www.ecolabel.eu](http://www.ecolabel.eu)

EU Ecolabel : DK/049/009



**VICO DUO™**  
VICO MAGISTRETTI 1997/2020

11.2023

The Vico Duo™ chair comes with a pressure moulded veneer shell and is available in two different finishes: Clear lacquered (oak or walnut) or black coloured ash (195) veneer. The shell is also available in front or fully upholstered versions in a wide range of textiles and leather types. Besides a four-legged tubular steel base, the Vico Duo™ is configurable with a sledge base made of solid steel, or as counter or bar stool with a four-legged tubular steel base. The chair is also available with a seat cushion in textile, mounted or purchased separately. Armrests are available on the models detailed below.

MODEL	DESCRIPTION	BLACK COLOURED ASH	CLEAR LACQUERED VENEER
VM110	Chair, stackable (max 10 pcs.), seat height 46 cm, 4 legs, chromed or black powder coated tubular steel base	3.439	3.439
VM111	Armchair, stackable (max 8 pcs.), seat height 46 cm, 4 legs, chromed or black powder coated tubular steel base	4.159	4.159
VM112	Chair w/welded linking device, stackable (max 8 pcs.), seat height 46 cm, 4 legs, chromed or black powder coated tubular steel base	4.559	4.559
VM113	Armchair w/welded linking device, stackable (max 8 pcs.), seat height 46 cm, 4 legs, chromed or black powder coated tubular steel base	5.599	5.599
VM114	Chair, stackable (max 8 pcs.), seat height 46 cm, chromed steel sledge base	3.439	3.439
VM115	Chair w/welded linking device, stackable (max 8 pcs.), seat height 46 cm, chromed steel sledge base	4.079	4.079
VM116	Counter stool, stackable (max 4 pcs.), seat height 64 cm, chromed or black powder coated tubular steel base	4.239	4.239
VM118	Bar stool, stackable (max 4 pcs.), seat height 76 cm, chromed or black powder coated tubular steel base	5.039	5.039

CLEAR LACQUERED VENEER - SEE THE SURFACE SELECTION  
OAK, WALNUT

**FRONT UPHOLSTERED - BLACK COLOURED ASH**

MODEL	DESCRIPTION	CHRISTIANSHAVN	CATEGORY 1	CATEGORY 2	CATEGORY 3	CATEGORY 4	CATEGORY 5
VM110	Chair, seat height 46 cm, 4 legs with arms, chromed or black powder coated tubular steel base	4.479	4.879	5.439	6.479	7.759	9.999
VM111	Armchair, seat height 46 cm, 4 legs, chromed or black powder coated tubular steel base	5.199	5.599	6.159	7.199	8.399	10.399
VM112	Chair w/welded linking device, seat height 46 cm, 4 legs, chromed or black powder coated tubular steel base	5.599	5.999	6.639	7.599	8.799	11.199
VM113	Armchair w/welded linking device, seat height 46 cm, 4 legs, chromed or black powder coated tubular steel base	6.639	7.039	7.599	8.799	9.999	11.999
VM114	Chair, seat height 46 cm, chromed steel sledge base	4.479	4.879	5.439	6.479	7.759	9.999
VM115	Chair w/welded linking device, seat height 46 cm, chromed steel sledge base	5.039	5.519	6.079	7.119	8.399	10.399
VM116	Counter stool, seat height 64 cm, chromed or black powder coated tubular steel base	5.279	5.679	6.319	7.359	8.799	10.799
VM118	Bar stool, seat height 76 cm, chromed or black powder coated tubular steel base	6.079	6.479	7.119	8.399	9.599	11.599

**FRONT UPHOLSTERED - CLEAR LACQUERED VENEER**

MODEL	DESCRIPTION	CHRISTIANSHAVN	CATEGORY 1	CATEGORY 2	CATEGORY 3	CATEGORY 4	CATEGORY 5
VM110	Chair, seat height 46 cm, 4 legs with arms, chromed or black powder coated tubular steel base	4.479	4.879	5.439	6.479	7.759	9.999
VM111	Armchair, seat height 46 cm, 4 legs, chromed or black powder coated tubular steel base	5.199	5.599	6.159	7.199	8.399	10.399
VM112	Chair w/welded linking device, seat height 46 cm, 4 legs, chromed or black powder coated tubular steel base	5.599	5.999	6.639	7.599	8.799	11.199
VM113	Armchair w/welded linking device, seat height 46 cm, 4 legs, chromed or black powder coated tubular steel base	6.639	7.039	7.599	8.799	9.999	11.999
VM114	Chair, seat height 46 cm, chromed steel sledge base	4.479	4.879	5.439	6.479	7.759	9.999
VM115	Chair w/welded linking device, seat height 46 cm, chromed steel sledge base	5.039	5.519	6.079	7.119	8.399	10.399
VM116	Counter stool, seat height 64 cm, chromed or black powder coated tubular steel base	5.279	5.679	6.319	7.359	8.799	10.799
VM118	Bar stool, seat height 76 cm, chromed or black powder coated tubular steel base	6.079	6.479	7.119	8.399	9.599	11.599

CATEGORY 1: BELFAST, CANVAS, CAPTURE, DIABLO, FAME, REMIX, TONUS  
 CATEGORY 2: DIVINA, DIVINA MELANGE, DIVINA MD, FIORD, HALLINGDAL, RE-WOOL, STEELCUT, STEELCUT TRIO, SUNNIVA  
 CATEGORY 3: COMFORT, ESSENTIAL  
 CATEGORY 4: SOFT  
 CATEGORY 5: GRACE, EMBRACE, NATURAL

SELECTED TEXTILE COLOURS - SEE THE SURFACE SELECTION  
 BELFAST (770593, 770660, 771772, 772062, 772143, 772150, 772255, 774232, 774926, 775139)  
 VANIR (193, 243, 373, 393, 413, 443, 473, 693, 733, 773, 913, 983)



FULLY UPHOLSTERED

MODEL	DESCRIPTION	CHRISTIANSHAVN	CATEGORY 1	CATEGORY 2	CATEGORY 3	CATEGORY 4	CATEGORY 5
VM110	Chair, seat height 46 cm, 4 legs with arms, chromed or black powder coated tubular steel base	4.959	5.359	5.999	7.599	9.599	13.599
VM111	Armchair, seat height 46 cm, 4 legs, chromed or black powder coated tubular steel base	5.679	6.079	6.719	8.399	10.399	13.999
VM112	Chair w/welded linking device, seat height 46 cm, 4 legs, chromed or black powder coated tubular steel base	6.079	6.479	7.119	8.799	10.799	14.799
VM113	Armchair w/welded linking device, seat height 46 cm, 4 legs, chromed or black powder coated tubular steel base	7.119	7.519	8.399	9.999	11.999	15.599
VM114	Chair, seat height 46 cm, chromed steel sledge base	4.959	5.359	5.999	7.599	9.599	13.599
VM115	Chair w/welded linking device, seat height 46 cm, chromed steel sledge base	5.599	5.999	6.639	8.399	10.399	13.999
VM116	Counter stool, seat height 64 cm, chromed or black powder coated tubular steel base	5.759	6.159	6.799	8.399	10.799	14.399
VM118	Bar stool, seat height 76 cm, chromed or black powder coated tubular steel base	6.639	7.039	7.599	9.199	11.599	15.199

CATEGORY 1: BELFAST, CANVAS, CAPTURE, DIABLO, FAME, REMIX, TONUS  
 CATEGORY 2: DIVINA, DIVINA MELANGE, DIVINA MD, FIORD, HALLINGDAL, RE-WOOL, STEELCUT, STEELCUT TRIO, SUNNIVA  
 CATEGORY 3: COMFORT, ESSENTIAL  
 CATEGORY 4: SOFT  
 CATEGORY 5: GRACE, EMBRACE, RUSTIK, NATURAL

SELECTED TEXTILE COLOURS - SEE THE SURFACE SELECTION  
 BELFAST (770593, 770660, 771772, 772062, 772143, 772150, 772255, 774232, 774926, 775139)  
 VANIR (193, 243, 373, 393, 413, 443, 473, 693, 733, 773, 913, 983)

OPTIONS

DESCRIPTION	PRICE
Small transport dolly for 10 pcs. Vico Duo chairs without arms (except counter and bar stool) and 8 pcs. with arms, non-upholstered	4.639
Felt glides (4 pcs.)	95
VM170 seat cushion, Just textile black (60999) or dark grey (60121)	655

VM110

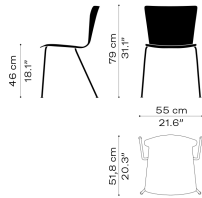

VM111

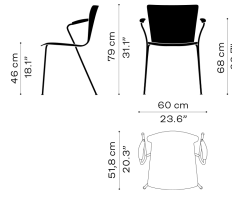

VM112

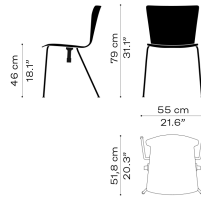

VM113

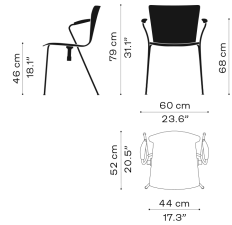

VM114

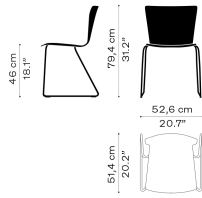

VM115

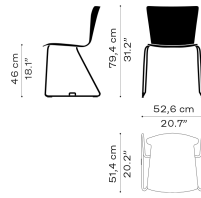

VM116

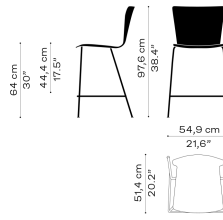

VM118

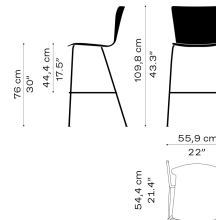

SMALL TRANSPORT DOLLY

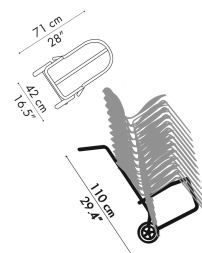



The Egg™ lounge chair comes fully upholstered in a wide range of textiles and leather types. The four-star base consists either of a satin chromed steel column connected to a base in satin brushed aluminium or a powder coated steel column connected to a base in powder coated aluminium. The inner shell is made of a hard moulded foam, padded with a softer foam structure to increase comfort. A matching Egg™ footstool is available in the same base and upholstery options as the Egg™ lounge chair.

MODEL	DESCRIPTION	CHRISTIANSHAVN	CATEGORY 1	CATEGORY 2	CATEGORY 3	CATEGORY 4	CATEGORY 5
3316	Lounge chair, 4-star base, tilt and swivel	70.799	74.799	79.199	104.399	132.399	153.599
3127	Footstool, 4-star base	21.599	22.799	23.199	25.199	28.399	32.399

CATEGORY 1: CANVAS, CAPTURE, DIABLO, FAME, TONUS  
 CATEGORY 2: DIVINA, DIVINA MELANGE, DIVINA MD, FIORD, HALLINGDAL, RE-WOOL, STEELCUT, STEELCUT TRIO, SUNNIVA  
 CATEGORY 3: COMFORT, ESSENTIAL  
 CATEGORY 4: AURA  
 CATEGORY 5: GRACE, EMBRACE, RUSTIK, NATURAL

BASE COLOURS  
 SILVER GREY, WARM GRAPHITE, BROWN BRONZE, BLACK, BRUSHED ALUMINIUM

**OPTIONS**

DESCRIPTION	PRICE
Automatic return for 3316	1.999

3316

3127

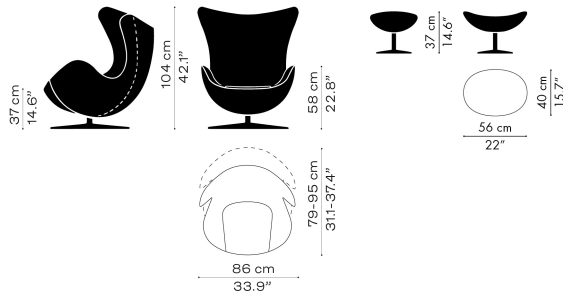



The Swan™ lounge chair comes fully upholstered in a wide range of textiles and leather types. The four-star base consists either of a satin chromed steel column connected to a base in satin brushed aluminium or a powder coated steel column connected to a base in powder coated aluminium. The inner shell is made of a hard moulded foam, padded with a softer foam structure to increase comfort.

MODEL	DESCRIPTION	CHRISTIANSHAVN	CATEGORY 1	CATEGORY 2	CATEGORY 3	CATEGORY 4	CATEGORY 5
3320	Lounge chair, 4-star base, swivel	39.999	42.399	44.799	60.799	70.799	82.799

CATEGORY 1: CAPTURE, DIABLO, FAME, TONUS  
 CATEGORY 2: DIVINA, DIVINA MELANGE, DIVINA MD, FIORD, HALLINGDAL, RE-WOOL, STEELCUT, STEELCUT TRIO, SUNNIVA  
 CATEGORY 3: COMFORT, ESSENTIAL  
 CATEGORY 4: AURA  
 CATEGORY 5: GRACE, EMBRACE, RUSTIK, NATURAL

**BASE COLOURS**  
 SILVER GREY, WARM GRAPHITE, BROWN BRONZE, BLACK, BRUSHED ALUMINIUM

DESCRIPTION	PRICE
Automatic return for 3320	1.999
Special seat height: 48 cm	535

**3320**

**3320 + 8 CM**

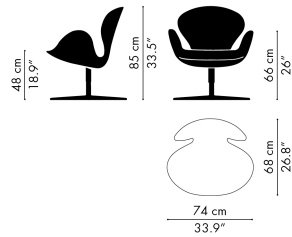
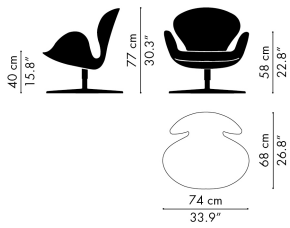



**OKSEN™**  
**ARNE JACOBSEN 1968/2017**

**11.2023**

Oksen™ lounge chair comes in three different leather types: Aura and Grace in the colours black and walnut as well as in Essential leather. The five-star base is available in black powder coated aluminium or satin brushed aluminium with a satin brushed steel column. A matching Oksen™ footstool is available in the same base and upholstery options as the Oksen™ lounge chair.

MODEL	DESCRIPTION	CATEGORY 3	CATEGORY 4	CATEGORY 5
4201	Lounge chair, swivel, satin brushed aluminium or black powder coated aluminium	104.399	130.399	147.999
4210	Footstool, satin brushed aluminium or black powder coated aluminium	26.399	31.599	34.799

CATEGORY 3: ESSENTIAL  
 CATEGORY 4: AURA (Black or Walnut)  
 CATEGORY 5: GRACE (Black or Walnut)

**OPTIONS**

DESCRIPTION	PRICE
Automatic return for 4201	1.999

4201

4210

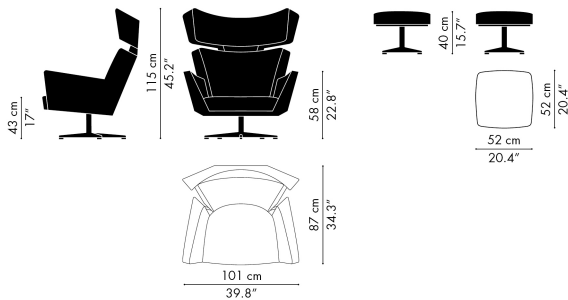





**POT™**  
**ARNE JACOBSEN 1959/2017**

**11.2023**

The Pot™ lounge chair comes fully upholstered in a wide range of textiles and leather types. The inner shell is made of a hard moulded foam, padded with a softer foam structure to increase comfort. The lounge chair's base consists of four legs in chromed or Brown Bronze powder coated tubular steel.

MODEL	DESCRIPTION	CHRISTIANSHAVN	CATEGORY 1	CATEGORY 2	CATEGORY 3	CATEGORY 4	CATEGORY 5
3318	Lounge chair, chromed or Brown Bronze powder coated tubular steel base	17.999	18.799	20.399	27.199	32.399	37.599

CATEGORY 1: CANVAS, CAPTURE, DIABLO, FAME, REMIX, TONUS  
 CATEGORY 2: DIVINA, DIVINA MELANGE, DIVINA MD, FIORD, HALLINGDAL, RE-WOOL, STEELCUT, STEELCUT TRIO, SUNNIVA  
 CATEGORY 3: COMFORT, ESSENTIAL  
 CATEGORY 4: AURA  
 CATEGORY 5: GRACE, EMBRACE, RUSTIK, NATURAL

**3318**

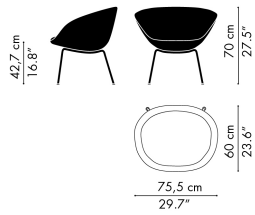



The Ro™ lounge chair comes fully upholstered in a wide range of textiles. Single textile or a mix of two textiles; one textile for the shell and one for the cushions. The base is available with four legs in brushed aluminium or solid oak with a clear lacquer finish. A matching Ro™ footstool is available in the same base and upholstery options as the Ro™ lounge chair. In 2022, designer Jaime Hayon has curated a new and exclusive textile selection for his Ro™ and Fri™ lounge chairs for Fritz Hansen, resting on four legs in brushed aluminium.

MODEL	DESCRIPTION	CHRISTIANSHAVN	CATEGORY 1	CATEGORY 2	CATEGORY 3
JH1	Lounge chair, brushed aluminium legs	31.599	33.199	33.199	42.799
JH2	Lounge chair, solid oak legs	31.599	33.199	33.199	42.799
JH11	Footstool, brushed aluminium legs	9.599	9.999	9.999	11.999
JH12	Footstool, solid oak legs	9.599	9.999	9.999	11.999

CATEGORY 1: CANVAS (ONLY CUSHIONS & FOOTSTOOL), CAPTURE, DIABLO (ONLY CUSHIONS & FOOTSTOOL), FAME, MOOD, REMIX (ONLY CUSHIONS & FOOTSTOOL), TONUS  
 CATEGORY 2: DIVINA, DIVINA MD, DIVINA MELANGE, FIORD, HALLINGDAL, NABIS, RE-WOOL, SAFIRE, STEELCUT, STEELCUT TRIO, SUNNIVA, TWILL WEAVE, VIDAR  
 CATEGORY 3: RAAS

JH1

JH2

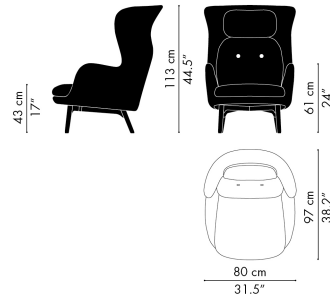
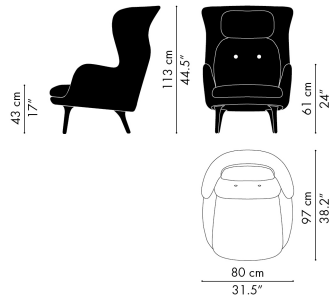

JH11

JH12

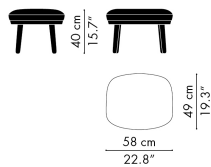
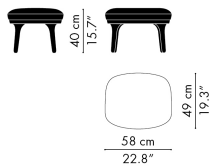



**FRI™**  
**JAIME HAYON 2015**

The Fri™ lounge chair comes fully upholstered in a wide range of textiles. Single textile or a mix of two textiles; one textile for the shell and one for the cushions. The base is available with four legs in brushed aluminium or solid oak with a clear lacquer finish. A matching Fri™ footstool is available in the same base and upholstery options as the Fri™ lounge chair. In 2022, designer Jaime Hayon has curated a new and exclusive textile selection for his Ro™ and Fri™ lounge chairs for Fritz Hansen, resting on four legs in brushed aluminium.

MODEL	DESCRIPTION	CHRISTIANSHAVN	CATEGORY 1	CATEGORY 2
JH4	Lounge chair, brushed aluminium legs	28.399	29.999	29.999
JH5	Lounge chair, solid oak legs	28.399	29.999	29.999
JH14	Footstool, brushed aluminium legs	9.599	9.999	9.999
JH15	Footstool, solid oak legs	9.599	9.999	9.999

CATEGORY 1: CANVAS, CAPTURE, FAME, REMIX, TONUS  
 CATEGORY 2: DIVINA, DIVINA MD, DIVINA MELANGE, FIORD, HALLINGDAL, RE-WOOL, SAFIRE, STEELCUT, STEELCUT TRIO, SUNNIVA, VIDAR

**JH4**

**JH5**

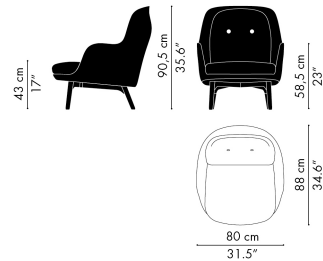
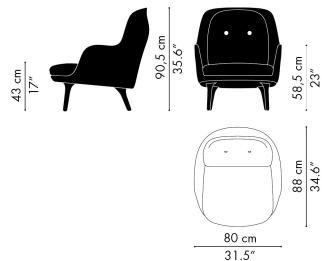

**JH14**

**JH15**

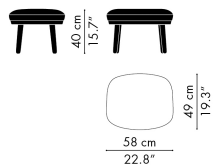
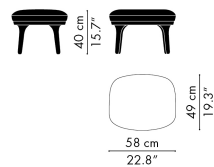



VIA57™  
BJARKE INGELS IN COLLABORATION WITH KIBISI 2016

11.2023

VIA57™ lounge chair comes fully upholstered in a range of textiles. The wooden base is made of solid oak with a clear lacquer finish. Seat and back are composed of soft moulded PE foam around an inner steel frame.

MODEL	DESCRIPTION	CHRISTIANSHAVN	CATEGORY 1	CATEGORY 2	CATEGORY 3
BIO1	Lounge chair, solid oak base	25.199	25.599	26.399	31.599

CATEGORY 1: CAPTURE, MESSENGER, TONUS

CATEGORY 2: DIVINA, DIVINA MD, DIVINA MELANGE, FIORD, HALLINGDAL, MERIT, RE-WOOL, STEELCUT, STEELCUT TRIO, SUNNIVA

CATEGORY 3: GENTLE

BIO1

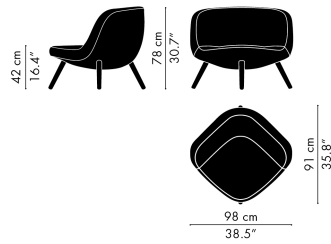



**FRED™**  
**JAIME HAYON 2019**

The Fred™ lounge chair is available in two types of solid wood and a total of four different finishes: Black coloured ash, clear lacquered (oak or walnut stained oak) or oiled oak. The upholstered cushions are available in a variety of textile and leather types.

MODEL	DESCRIPTION	CHRISTIANSHAVN	CATEGORY 1	CATEGORY 2	CATEGORY 3	CATEGORY 4
JH97	Lounge chair, Black coloured ash	21.999	23.199	24.399	28.399	32.799
JH97	Lounge chair, Walnut stained oak	21.999	23.199	24.399	28.399	32.799
JH97	Lounge chair, Clear lacquered oak	23.199	23.999	25.199	29.199	33.599
JH97	Lounge chair, Natural oiled oak	23.199	23.999	25.199	29.199	33.599

CATEGORY 1: BELFAST  
 CATEGORY 2: HARALD, HALLINGDAL, RE-WOOL  
 CATEGORY 3: ESSENTIAL  
 CATEGORY 4: RIA

SELECTED TEXTILE COLOURS - SEE THE SURFACE SELECTION  
 BELFAST (770593, 770660, 771772, 772062, 772143, 772150, 772255, 774232, 774926, 775139)

**JH97**

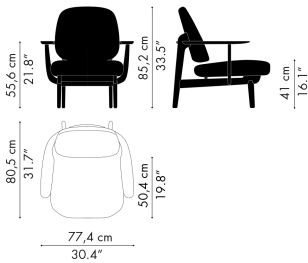



**LET™**  
**SEBASTIAN HERKNER 2020**

**11.2023**

The Let™ lounge chair comes fully upholstered and is available in a wide range of textiles and leather. Inner seat and backrest of the chair are made from PUR-foam moulded around an inner steel frame. The four-legged base of the Let™ lounge chair is available either in solid wood or tubular steel. The wooden bases come with a clear lacquered oak, clear lacquered ash or black coloured ash finish, while steel bases are available in chrome or powder coated in Black, Warm Graphite or Brown Bronze.

MODEL	DESCRIPTION	CHRISTIANSHAVN	CATEGORY 1	CATEGORY 2	CATEGORY 3
SH200	Lounge chair, wooden base	18.399	19.199	19.999	21.999
SH210	Lounge chair, chromed or powder coated tubular steel base	17.599	18.399	19.199	20.799

CATEGORY 1: CANVAS, REMIX, FAME, TONUS, HUE

CATEGORY 2: DIVINA, DIVINA MD, DIVINA MELANGE, FIORD, HALLINGDAL, RE-WOOL, STEELCUT, STEELCUT TRIO, SUNNIVA, VIDAR

CATEGORY 3: ESSENTIAL

**BASE COLOURS**

SH200: CLEAR LACQUERED OAK, CLEAR LACQUERED ASH OR BLACK COLOURED ASH

SH210: WARM GRAPHITE, BROWN BRONZE, BLACK, CHROME

**SH200**

**SH210**

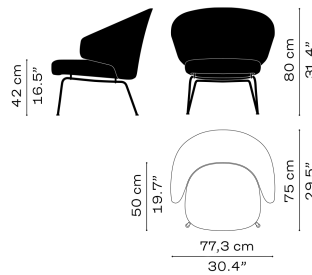
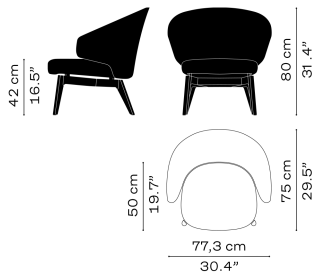



## ALPHABET™ SOFA SERIES PIERO LISSONI 2008

11.2023

The Alphabet™ Sofa Series is a modular sofa system with units that can be combined in a variety of ways. The fully upholstered seat, back and armrest units come in a wide range of textiles, which can be removed for cleaning or replacement. You can choose to include a piping along the edges on both seat, back and armrests.

MODEL	DESCRIPTION	CHRISTIANSHAVN	CATEGORY 1	CATEGORY 2
PL210-1	2-seater sofa, 1 corner backrest, 1 backrest, 1 armrest	52.399	55.199	57.999
PL210-2	2-seater sofa, 1 corner backrest, 1 backrest, 1 armrest	52.399	55.199	57.999
PL210-3	2-seater sofa, 1 corner backrest, 1 backrest	45.999	48.399	51.199
PL210-4	2-seater sofa, 1 corner backrest, 1 backrest	45.999	48.399	51.199
PL240-1	2-seater sofa, 1 backrest, 2 armrests	53.199	55.999	58.799
PL240-2	2-seater sofa, 1 corner backrest, 1 backrest, 1 armrest	55.999	58.799	61.999
PL240-3	2-seater sofa, 1 corner backrest, 1 backrest, 1 armrest	55.999	58.799	61.999
PL240-4	2-seater sofa, 1 corner backrest, 1 backrest	48.399	51.199	53.999
PL240-5	2-seater sofa, 1 corner backrest, 1 backrest	48.399	51.199	53.999
PL255-1	3-seater sofa, 1 backrest, 2 armrests	62.399	65.599	68.799
PL270-1	3-seater sofa, 1 backrest, 2 armrests	63.999	67.599	70.799
PL300-1	3-seater sofa, 1 corner backrest, 2 backrests, 1 armrest	72.399	76.399	80.399
PL300-2	3-seater sofa, 1 corner backrest, 2 backrests, 1 armrest	72.399	76.399	80.399
PL300-3	4-seater sofa, 1 corner backrest, 2 backrests	82.399	86.799	91.599
PL300-4	4-seater sofa, 1 corner backrest, 2 backrests	82.399	86.799	91.599

MODEL	DESCRIPTION	CHRISTIANSHAVN	CATEGORY 1	CATEGORY 2
PL75-105	Sofa seat unit	11.999	12.799	13.199
PL90-105	Sofa seat unit	13.199	13.999	14.799
PL120-105	Sofa seat unit	14.799	15.599	16.399
PL120-120	Sofa seat unit	16.399	17.199	18.399

### BASE UNITS - BACK

MODEL	DESCRIPTION	CHRISTIANSHAVN	CATEGORY 1	CATEGORY 2
PL75-30	Sofa back unit	6.399	6.719	6.959
PL90-30	Sofa back unit	7.039	7.359	7.759
PL120-30	Sofa back unit	7.759	8.399	8.799
PL150-30	Sofa back unit	9.599	9.999	10.399
PL180-30	Sofa back unit	10.399	11.199	11.599
PL240-30	Sofa back unit	11.999	12.799	13.599
PL255-30	Sofa back unit	12.799	13.599	14.399
PL270-30	Sofa back unit	13.599	14.399	15.199
PL90-90-30	Corner backrest	9.599	9.999	10.799

### BASE UNITS - ARMREST

MODEL	DESCRIPTION	CHRISTIANSHAVN	CATEGORY 1	CATEGORY 2
PL60-30	Armrest	5.679	5.999	6.239

MODEL	DESCRIPTION	CHRISTIANSHAVN	CATEGORY 1	CATEGORY 2
PL001	Additional sofa cushion (1 pcs.)	1.759	1.839	1.999

CATEGORY 1: CANVAS, CAPTURE, DIABLO, FAME, HUE, REMIX, TONUS  
CATEGORY 2: DIVINA, DIVINA MELANGE, DIVINA MD, FIORD, HALLINGDAL, KARAKORUM, RE-WOOL, STEELCUT, STEELCUT TRIO, SUNNIVA

ALPHABET COVERS ARE AVAILABLE FOR ALL MODULES AT 35% OF THE MODULE PRICE  
PIPING ALONG THE EDGES ON BOTH SEAT, BACK AND ARMRESTS IS AVAILABLE AT NO ADDITIONAL COST



PL210-1

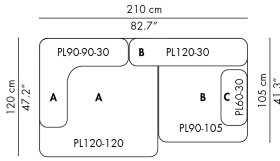

PL210-2

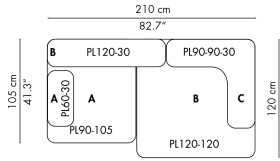

PL210-3

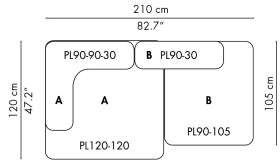

PL210-4

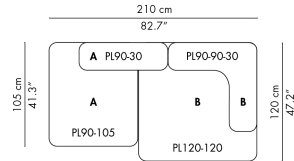

PL240-1

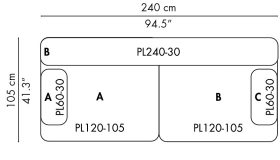

PL240-2

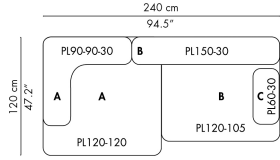

PL240-3

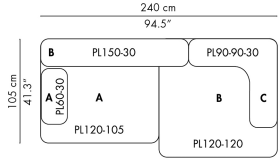

PL240-4

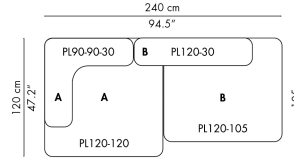

PL240-5

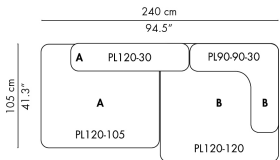

PL255-1

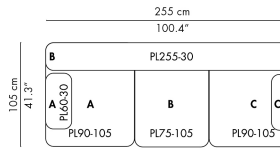

PL270-1

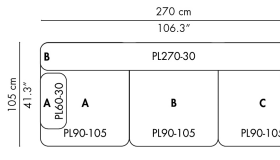

PL300-1

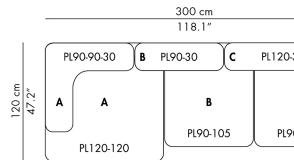

PL300-2

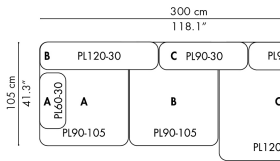

PL300-3

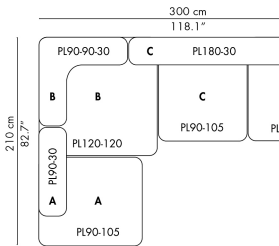

PL300-4

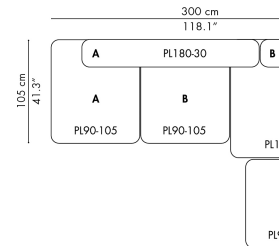

PL75-105

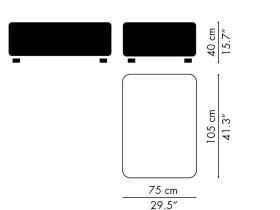

PL90-105

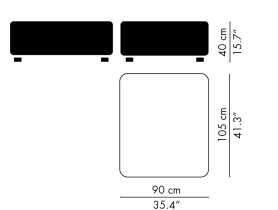

PL120-105

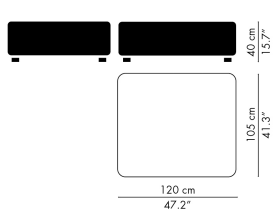

PL120-120

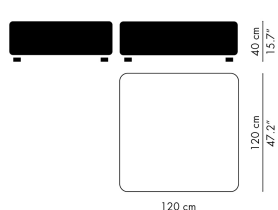

PL90-90-30

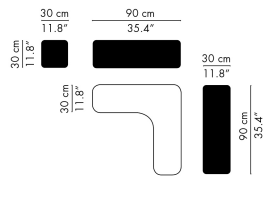

PL75-30

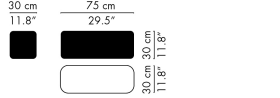

PL90-30



PL120-30

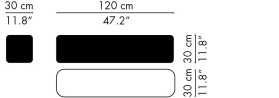

PL150-30

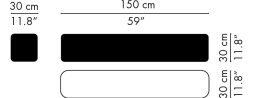

PL180-30

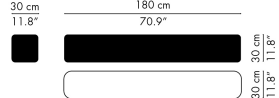

PL240-30

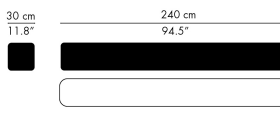

PL255-30

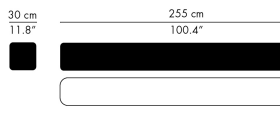

PL270-30

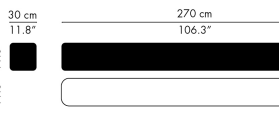

PL60-30

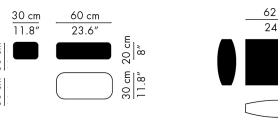

PL001

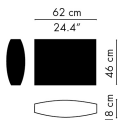





**FAVN™**  
**JAIME HAYON 2011**

**11.2023**

The Favn™ sofa comes in a wide range of textiles. It is available with a single coherent textile or a mix of up to three textiles; one textile for the shell and base, a second for the seat and back cushions and third textile for the small decorative cushions. The inner shell of the sofa is made of a hard moulded foam, padded with a soft, comfort-enhancing foam structure. The legs are made of brushed aluminium and a set of felt glides (for soft wooden floors) comes with the sofa as a standard.

MODEL	DESCRIPTION	CHRISTIANSHAVN	CATEGORY 1	CATEGORY 2
JH3	3-seater sofa, brushed aluminium legs incl. 2 loose decorative cushions	103.199	108.799	108.799

**OPTIONS**

MODEL	DESCRIPTION	CHRISTIANSHAVN	CATEGORY 1	CATEGORY 2
JH9	Additional decorative sofa cushion (1 pcs.)	2.879	2.959	2.959

CATEGORY 1: CANVAS (ONLY SEAT/BACK & DECORATIVE CUSHIONS), CAPTURE, DIABLO (ONLY SEAT/BACK & DECORATIVE CUSHIONS), FAME, REMIX (ONLY SEAT/BACK & DECORATIVE CUSHIONS), TONUS  
 CATEGORY 2: DIVINA, DIVINA MELANGE, DIVINA MD, FIORD, HALLINGDAL, RE-WOOL, STEELCUT, STEELCUT TRIO, SUNNIVA

**JH3**

**JH9**

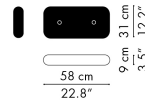
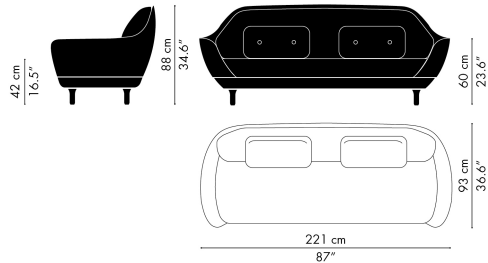



**LUNE™**  
JAIME HAYON 2017

11.2023

Lune™ is a modular sofa available in nine standard configurations featuring six different modules. The various modules can also be individually combined to create customised configurations. Lune™ comes fully upholstered in a variety of textiles and leather types. The base is available in brushed aluminium, or in two solid wood options: Clear lacquered oak or black coloured oak.

MODEL	DESCRIPTION	CHRISTIANSHAVN	CATEGORY 1	CATEGORY 2	CATEGORY 4	CATEGORY 5
JH200	Sofa, 2-seater, wooden or aluminium base	45.599	47.999	53.199	104.399	139.199
JH300	Sofa, 3-seater, wooden or aluminium base	63.599	67.199	73.999	139.199	191.599
JH301	Sofa, 3-seater with left chaise longue, wooden or aluminium base	73.599	77.599	85.999	151.599	212.399
JH302	Sofa, 3-seater with right chaise longue, wooden or aluminium base	73.599	77.599	85.999	151.599	212.399
JH400	Sofa, 4-seater, wooden or aluminium base	81.999	85.999	94.799	173.999	243.599
JH500	Sofa, 5-seater, wooden or aluminium base	99.999	105.199	115.599	208.799	295.599
JH510	Sofa, 5-seater with corner, wooden or aluminium base	118.399	124.399	136.799	234.799	347.999
JH600	Sofa, 6-seater, wooden or aluminium base	127.999	134.799	147.199	243.599	365.199
JH610	Sofa, 6-seater with corner, wooden or aluminium base	137.999	145.199	160.799	269.599	399.999

**SOFA MODULES**

MODEL	DESCRIPTION	CHRISTIANSHAVN	CATEGORY 1	CATEGORY 2	CATEGORY 4	CATEGORY 5
JH001	Sofa central module, wooden or aluminium base	20.799	21.999	24.399	39.999	57.599
JH002L	Sofa arm module left, wooden or aluminium base	23.999	25.199	27.999	48.799	69.599
JH002R	Sofa arm module right, wooden or aluminium base	23.999	25.199	27.999	48.799	69.599
JH003	Sofa corner module, wooden or aluminium base	32.399	33.999	36.799	60.799	87.199
JH004L	Sofa chaise longue module left, wooden or aluminium base	32.399	33.999	36.799	64.399	90.399
JH004R	Sofa chaise longue module right, wooden or aluminium base	32.399	33.999	36.799	64.399	90.399

CATEGORY 1: CANVAS, CAPTURE, DIABLO, FAME, LINARA, REMIX, TONUS  
 CATEGORY 2: DIVINA, DIVINA MELANGE, DIVINA MD, FIORD, HALLINGDAL, RE-WOOL, STEELCUT, STEELCUT TRIO, SUNNIVA  
 CATEGORY 4: AURA, SOFT  
 CATEGORY 5: EMBRACE

**BASE COLOURS**  
 BRUSHED ALUMINIUM, CLEAR LACQUERED OAK, BLACK COLOURED OAK

**SELECTED TEXTILE COLOURS - SEE THE SURFACE SELECTION**  
 LINARA (2494/198, 2494/324, 2494/118, 2494/340, 2494/30, 2494/237)



JH200

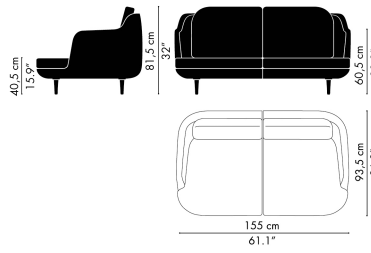

JH300

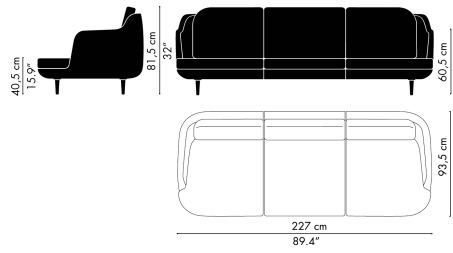

JH301

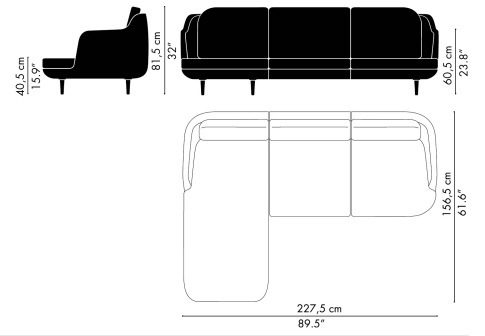

JH302

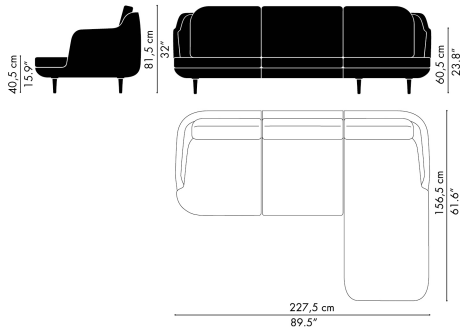

JH400

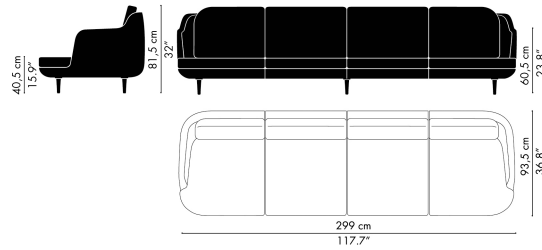

JH500

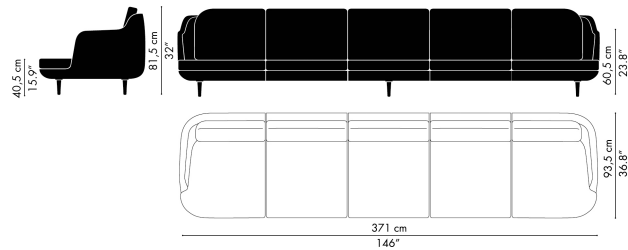

JH600

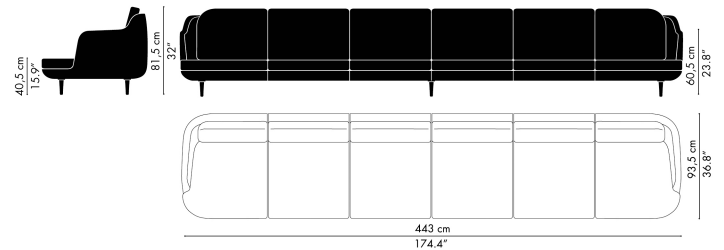

JH510

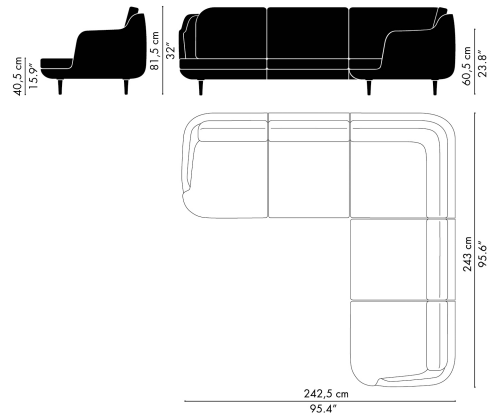

JH610

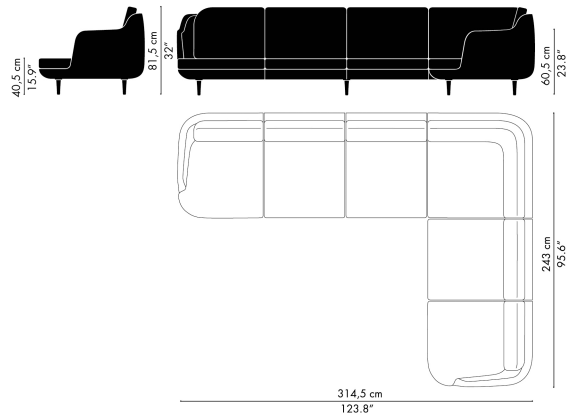

JH001

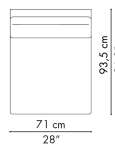

JH002L

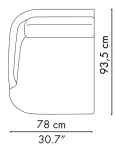

JH002R

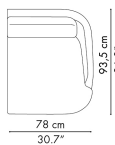

JH003

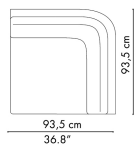

JH004L

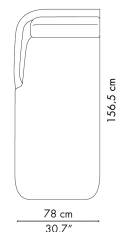

JH004R

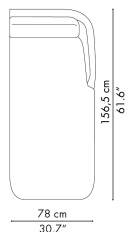



**RO™ SOFA**  
**JAIME HAYON 2017**

**11.2023**

The Ro™ Sofa comes fully upholstered in a wide range of textiles. As a single textile or a mix of two textiles; one textile for the shell and one for the cushions. The base consists of four legs in brushed aluminium or is available wooden base in solid oak with a clear lacquer finish.

MODEL	DESCRIPTION	CHRISTIANSHAVN	CATEGORY 1	CATEGORY 2
JH110	2-seater sofa, brushed aluminium legs	64.399	67.999	67.999
JH120	2-seater sofa, solid oak base	69.599	73.199	73.199

CATEGORY 1: CANVAS (ONLY CUSHIONS), CAPTURE, DIABLO (ONLY CUSHIONS), FAME, REMIX (ONLY CUSHIONS), TONUS  
 CATEGORY 2: DIVINA, DIVINA MELANGE, DIVINA MD, FIORD, HALLINGDAL, RE-WOOL, STEELCUT, STEELCUT TRIO, SUNNIVA

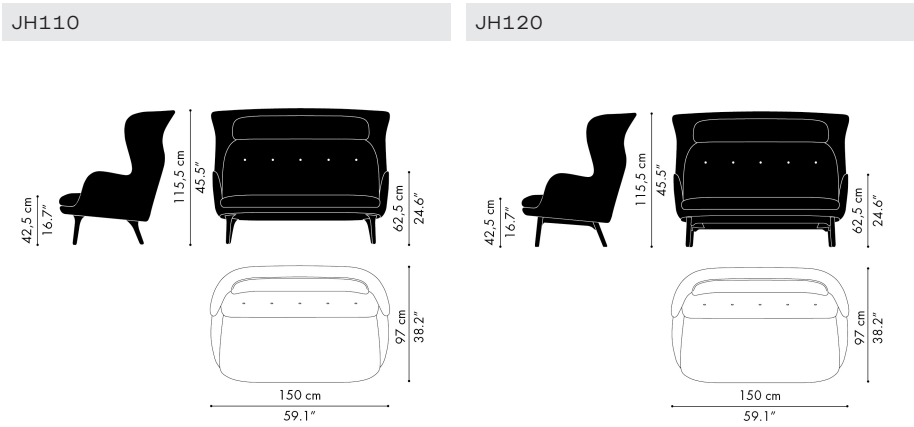



**PLENUM™**  
JAIME HAYON 2018

11.2023

Plenum™ is a high-back sofa system available as a one-, two- or three-seater. It offers features such as power plug and mounted side tables. Two table variants are also available.

**SOFAS**

MODEL	DESCRIPTION	CHRISTIANSHAVN	CATEGORY 1	CATEGORY 2
JH1001	One seater sofa, black powder coated steel base	58.399	61.599	67.199
JH1002	Two seater sofa, black powder coated steel base	76.399	80.399	85.999
JH1003	Three seater sofa, black powder coated steel base	90.399	95.199	100.799

CATEGORY 1: CANVAS, CAPTURE, FAME, REMIX, TONUS, MESSENGER  
 CATEGORY 2: DIVINA, DIVINA MELANGE, DIVINA MD, FIORD, HALLINGDAL, RE-WOOL, STEELCUT, STEELCUT TRIO

**TABLES**

MODEL	DESCRIPTION	LAMINATE (POLYREY)
JH70	Side sofa table, light grey laminate, black base	9.599
JH75	Coffee table, light grey laminate, black base	11.199
JH80	Table, light grey laminate, black base	13.199

JH70 MUST BE ORDERED TOGETHER WITH SOFA AND IS NOT INTERCHANGEABLE

**OPTIONS**

DESCRIPTION	PRICE
PU01, Power unit for sofa, black (1 pcs., available in select markets only)	5.519

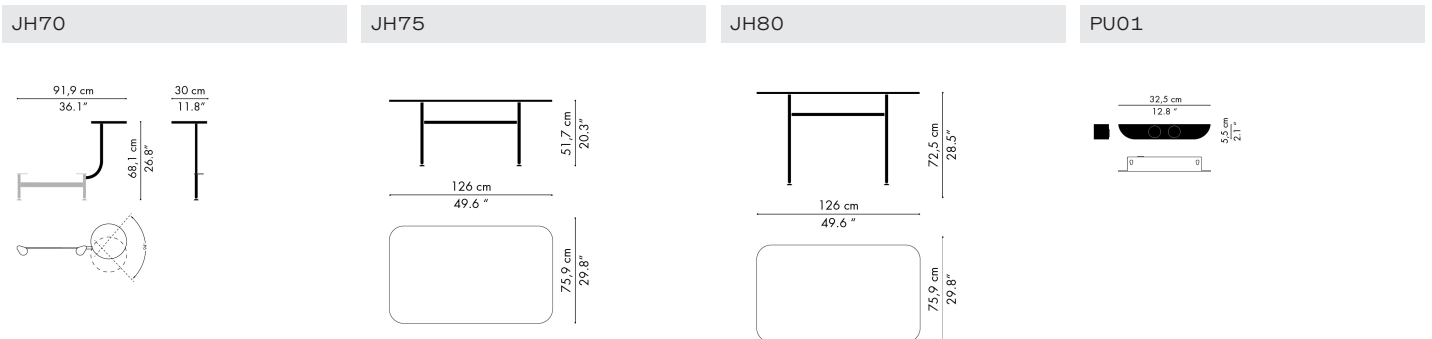
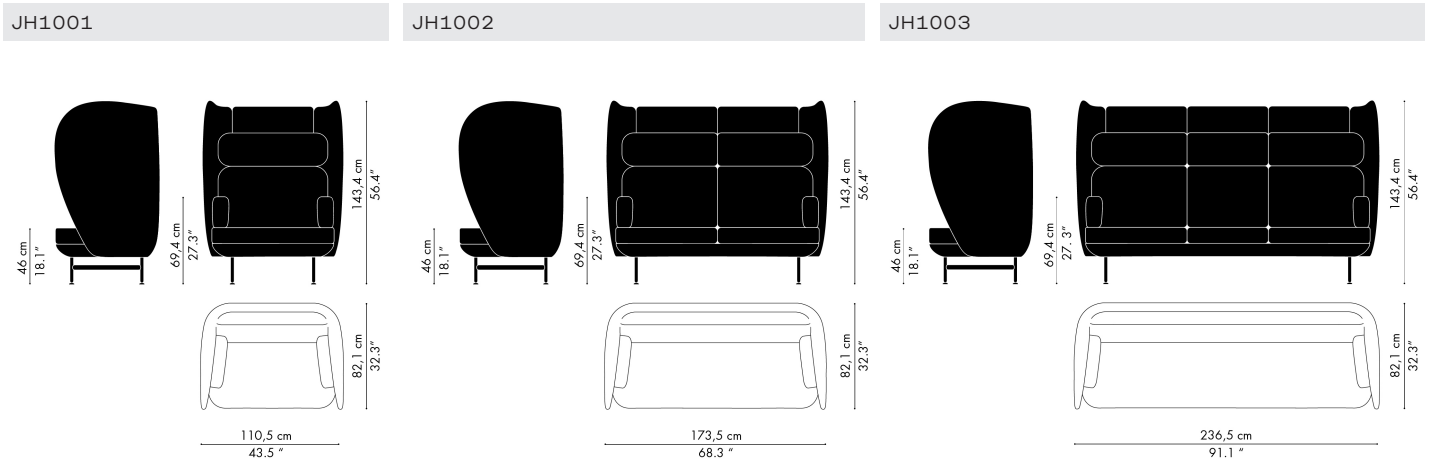

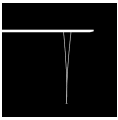

**SUPERELLIPSE™**  
PIET HEIN/BRUNO MATHSSON 1968

11.2023

The Superellipse™ tables are available in various sizes and with a tabletop made of either Fenix laminate or clear lacquered walnut veneer. While laminate versions come with an aluminium edge, the walnut veneer versions come with a natural wooden edge. The table's iconic span legs are available either in chromed or powder coated steel.

**DINING TABLES (HEIGHT 72 CM)**

MODEL	DESCRIPTION	FENIX LAMINATE	CLEAR LACQUERED WALNUT	H/L/W
B611	Table, span legs, detachable	21.199	30.799	72/135/90
B612	Table, span legs, detachable	23.199	32.799	72/150/100
B616	Table, span legs, detachable	24.799	35.999	72/170/100
B613	Table, span legs, detachable	26.799	40.399	72/180/120
B614	Table, span legs, detachable	35.599	53.599	72/240/120
B617	Table, span legs, detachable	55.199	82.799	72/300/130
B6180	Table, span legs, detachable	27.599	41.599	72/180/100
B6200	Table, span legs, detachable	31.199	45.999	72/200/100
B6240	Table, span legs, detachable	36.399	55.199	72/240/100

**OPTIONS**

DESCRIPTION	PRICE
Span legs, table height 52 cm (B2), 70 cm (B4) or 74 cm (B8)	1.039

FENIX LAMINATE COLOURS - SEE THE SURFACE SELECTION  
WHITE, GREY, BLACK, BROWN OTTAWA, GREY BROMO, GREY EFESO

SPAN LEGS COLOURS  
SILVER GREY, WARM GRAPHITE, BROWN BRONZE, BLACK, WHITE, NINE GREY, CHROME

**B611**

90 X 135 CM ( 76 CM )

**B612**

100 X 150 CM ( 92 CM )

**B616**

100 X 170 CM ( 99 CM )

**B613**

120 X 180 CM ( 99 CM )

**B614**

120 X 240 CM ( 144 CM )

**B617**

130 X 300 CM ( 187 CM )

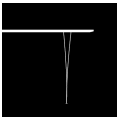

**EXTENSION TABLES (HEIGHT 72 CM)**

MODEL	DESCRIPTION	FENIX LAMINATE		CLEAR LACQUERED WALNUT	H/L/W
B620	Table, span legs, detachable	49.599	79.599	72/170(270)/100	
B619	Table, span legs, detachable	53.199	87.999	72/180(300)/120	

**OPTIONS**

DESCRIPTION	PRICE
Span legs, table height 52 cm (B2), 70 cm (B4) or 74 cm (B8)	1.039

FENIX LAMINATE COLOURS - SEE THE SURFACE SELECTION  
WHITE, GREY, BLACK, BROWN OTTAWA, GREY BROMO, GREY EFESO

SPAN LEGS COLOURS  
SILVER GREY, WARM GRAPHITE, BROWN BRONZE, BLACK, WHITE, NINE GREY, CHROME

**B620**

100 X 170/270 CM

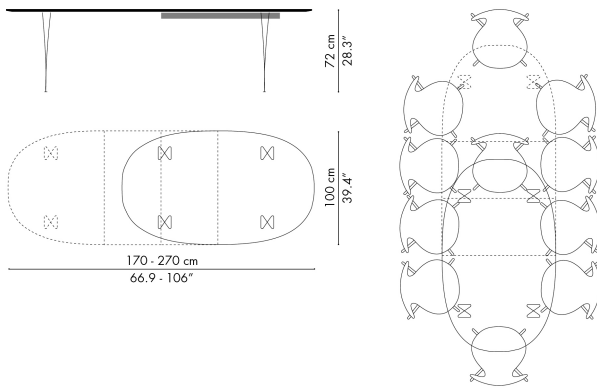

**B619**

120 X 180/300 CM

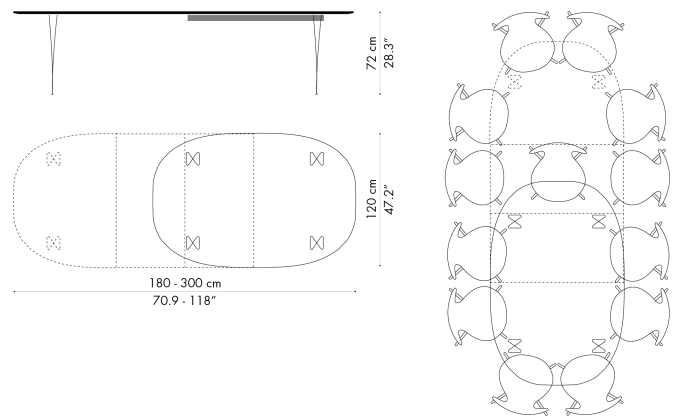









**RECTANGULAR**  
**PIET HEIN/BRUNO MATHSSON/ARNE JACOBSEN 1968**

**11.2023**

The Rectangular tables are available in two sizes and with a tabletop made of either Fenix laminate or clear lacquered walnut veneer. While laminate versions come with an aluminium edge, the walnut veneer versions come with a natural wooden edge. The table's iconic span legs are available either in chromed or powder coated steel.

**DINING TABLES (HEIGHT 72 CM)**

MODEL	DESCRIPTION	FENIX LAMINATE	CLEAR LACQUERED WALNUT	H/L/W
B637	Table, span legs, detachable	21.199	31.999	72/140/80
B638	Table, span legs, detachable	23.999	33.599	72/160/80

**OPTIONS**

DESCRIPTION	PRICE
Span legs, table height 52 cm (B2), 70 cm (B4) or 74 cm (B8)	1.039

**FENIX LAMINATE COLOURS - SEE THE SURFACE SELECTION**  
 WHITE, GREY, BLACK, BROWN OTTAWA, GREY BROMO, GREY EFESO

**SPAN LEGS COLOURS**  
 SILVER GREY, WARM GRAPHITE, BROWN BRONZE, BLACK, WHITE, NINE GREY, CHROME

**B637**

80 X 140 CM | 112 CM |

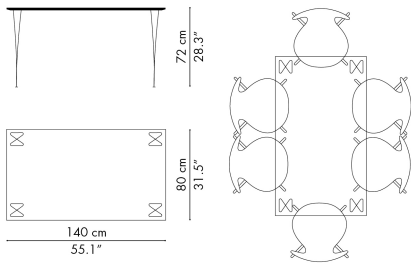

**B638**

80 X 160 CM | 121 CM |

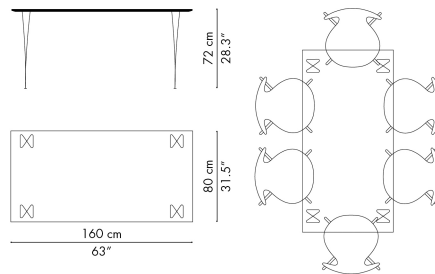



**FH3605™**  
ARNE JACOBSEN 1955

11.2023

The FH3605™ table or "Writing Desk" is a rectangular table available in either black coloured ash or clear lacquered walnut veneer. The base consists of four legs made of chromed or black powder coated steel with a solid wood detail matching the tabletop. FH3605™ is available with one document drawer in solid wood in walnut or black coloured ash (195). The drawer can be installed in either left or right side.

MODEL	DESCRIPTION	BLACK COLOURED ASH	CLEAR LACQUERED WALNUT	H/L/W
3605DD	Desk with drawer, veneer table top, chromed or powder coated steel, table height 72 cm or 74 cm	31.199	34.399	72/152/80
3605DE	Desk, veneer table top, chromed or powder coated steel, table height 72 cm or 74 cm	25.599	28.399	72/152/80
3605DR	Drawer, solid wood	5.679	6.399	8/52/30

FH3605DD

FH3605DE

FH3605DR

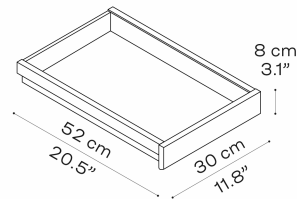
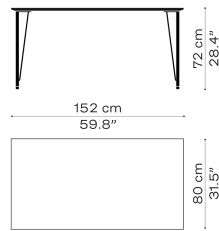
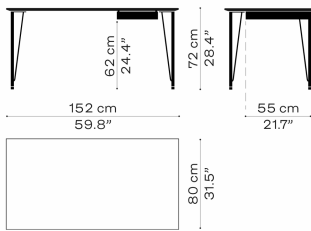



The Essay™ table comes in three sizes and is made of solid oak which is treated with either natural or white pigmented oil. The Essay™ extension leaf comes in two widths and is available in black Fenix laminate.

MODEL	DESCRIPTION	NATURAL OAK	WHITE PIGMENTED OAK	H/L/W
CM21	Table, solid oak	47.599	47.599	72/218/95
CM27	Table, solid oak	63.199	63.199	72/272/100
CM31	Table, solid oak	78.799	78.799	72/317/100

**EXTENSION LEAF**

MODEL	DESCRIPTION	BLACK FENIX LAMINATE	L/W
CM95	Extension leaf, black laminate tabletop	7.279	48/95
CM100	Extension leaf, black laminate tabletop	7.279	48/100

**CM21**

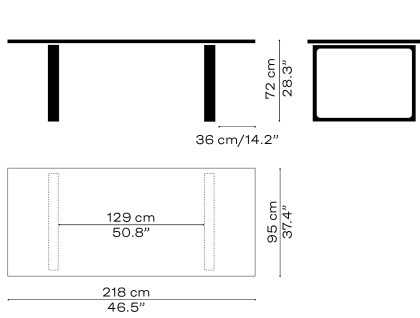

95 X 218 CM | 129 CM |

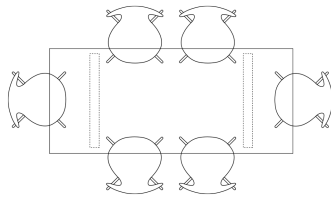

**CM21 + 2/CM95**

95 X 218/314 CM | 129 CM |

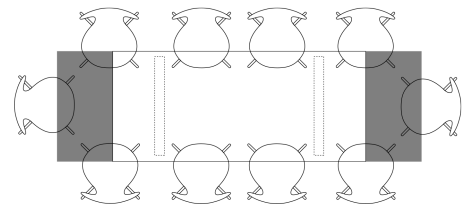

**CM27**

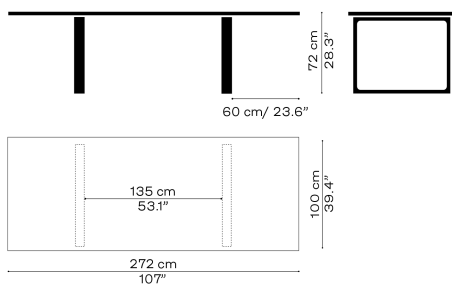

100 X 272 CM | 135 CM |

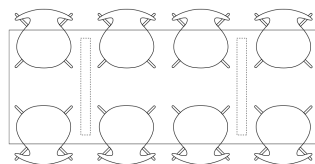

**CM27 + 2/CM100**

100 X 272/368 CM | 135 CM |

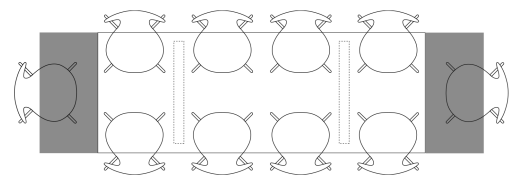



CM31

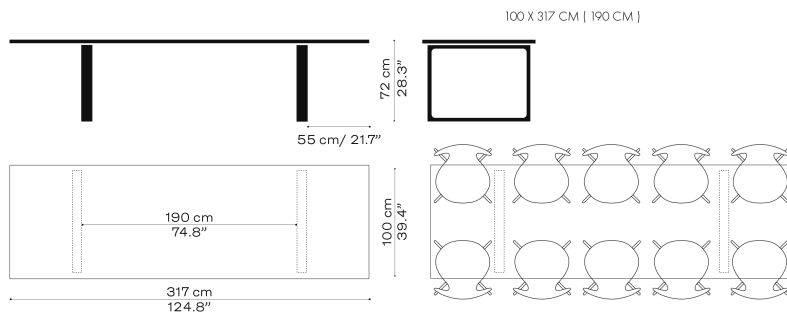

CM31 + 2/CM100

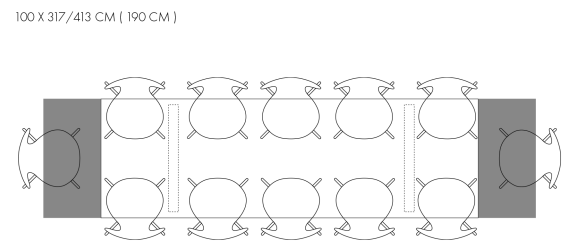

CM95

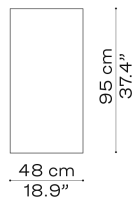

CM100

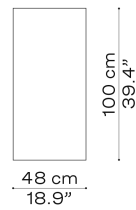



The Analog™ table comes in three sizes with a tabletop in either white laminate (Pfleiderer), clear lacquered oak or walnut veneer. The base consists of four legs made of solid wood, which can be configured in either black coloured oak, clear lacquered oak or walnut. The legs are attached to the table top with a 'trumpet' in either white or black powder coated aluminium. The underside of the table top is coloured in colours matching the trumpet.

MODEL	DESCRIPTION	LAMINATE (PFLEIDERER)	CLEAR LACQUERED VENEER	H/L/W
JH43	Table, laminate or veneer top, legs in solid wood	17.999	20.799	72/130/105
JH63	Table, laminate or veneer top, legs in solid wood	20.799	26.399	72/185/105
JH83	Table, laminate or veneer top, legs in solid wood	25.199	32.799	72/245/105

TABLE WITH TABLETOP IN WHITE LAMINATE OR CLEAR LACQUERED OAK VENEER IS AVAILABLE WITH LEGS IN CLEAR LACQUERED OAK AND WHITE TRUMPET. TABLE WITH TABLETOP IN CLEAR LACQUERED WALNUT VENEER IS AVAILABLE WITH LEGS IN BLACK COLOURED OAK OR CLEAR LACQUERED WALNUT, BOTH WITH BLACK TRUMPET.

**JH43**

105 X 130 CM ( 66 CM )

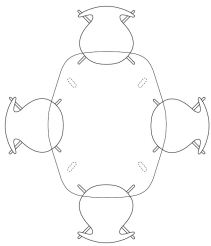
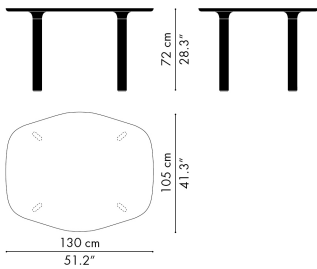

**JH63**

105 X 185 CM ( 117 CM )

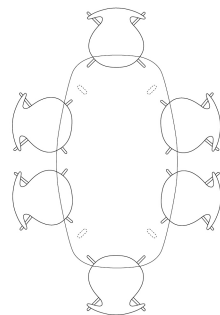
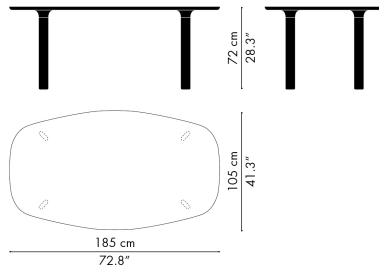

**JH83**

105 X 245 CM ( 177 CM )

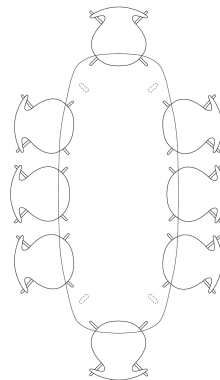
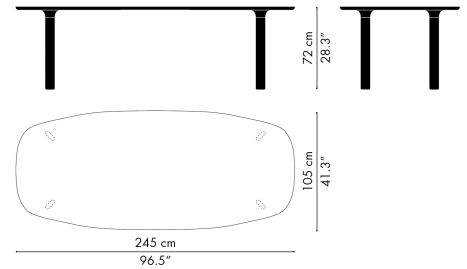



**PLURALIS™**  
KASPER SALTO 2016

11.2023

The Pluralis™ table comes in a wide range of sizes and with five different table tops: Mauve Brown linoleum, Lava Grey or white laminate (Polyrey) and clear lacquered oak or walnut veneer. The base is made of die-cast aluminium and comes with a polished or powder coated finish. The base is mounted with adjustable glides. Electrification and cable management are optionally available.\*

MODEL	DESCRIPTION	LAMINATE (POLYREY)	LINOLEUM	ENEER: OAK	ENEER: WALNUT
KS420	Table, polished or powder coated aluminium, 80 cm x 160 cm	19.599	23.199	30.399	30.799
KS421	Table, polished or powder coated aluminium, 80 cm, 90 cm, or 100 cm x 200 cm	23.999	28.799	37.599	37.999
KS422	Table, polished or powder coated aluminium, 80 cm, 90 cm, 100 cm or 120 cm x 240 cm	29.199	34.799	45.599	46.399
KS423	Table, polished or powder coated aluminium, 90 cm, 100 cm or 120 cm x 320 cm	38.799	46.799	60.399	61.999
KS424	Table, polished or powder coated aluminium, 90 cm, 100 cm or 120 cm x 480 cm	58.399	69.999	90.799	92.399
KS425	Table, polished or powder coated aluminium, 90 cm, 100 cm or 120 cm x 720 cm	83.199	99.599	129.599	132.399

**1 OVERHANG**

MODEL	DESCRIPTION	LAMINATE (POLYREY)	LINOLEUM	ENEER: OAK	ENEER: WALNUT
KS42001	Table, polished or powder coated aluminium, 80 cm x 185 cm	22.799	27.199	35.199	35.999
KS42101	Table, polished or powder coated aluminium, 80 cm, 90 cm, or 100 cm x 225 cm	27.199	32.799	42.399	43.199
KS42201	Table, polished or powder coated aluminium, 80 cm, 90 cm, 100 cm or 120 cm x 265 cm	32.399	38.799	50.399	51.599
KS42301	Table, polished or powder coated aluminium, 90 cm, 100 cm or 120 cm x 345 cm	41.999	50.399	65.599	66.799
KS42401	Table, polished or powder coated aluminium, 90 cm, 100 cm or 120 cm x 505 cm	61.199	73.599	95.599	97.599
KS42501	Table, polished or powder coated aluminium, 90 cm, 100 cm or 120 cm x 745 cm	86.399	103.599	134.399	137.199

**2 OVERHANGS**

MODEL	DESCRIPTION	LAMINATE (POLYREY)	LINOLEUM	ENEER: OAK	ENEER: WALNUT
KS42002	Table, polished or powder coated aluminium, 80 cm x 210 cm	25.199	29.999	38.799	39.599
KS42102	Table, polished or powder coated aluminium, 80 cm, 90 cm, or 100 cm x 250 cm	29.599	35.599	45.999	46.799
KS42202	Table, polished or powder coated aluminium, 80 cm, 90 cm, 100 cm or 120 cm x 290 cm	34.799	41.599	53.999	55.199
KS42302	Table, polished or powder coated aluminium, 90 cm, 100 cm or 120 cm x 370 cm	44.399	53.199	69.199	70.399
KS42402	Table, polished or powder coated aluminium, 90 cm, 100 cm or 120 cm x 530 cm	63.599	76.399	99.199	101.199
KS42502	Table, polished or powder coated aluminium, 90 cm, 100 cm or 120 cm x 770 cm	88.799	106.399	138.399	140.799

LAMINATE COLOURS: WHITE, LAVA GREY

LINOLEUM COLOURS: MAUVE BROWN

CLEAR LACQUERED VENEER: Oak, Walnut

BASE COLOURS: WARM GRAPHITE, BROWN BRONZE, BLACK, POLISHED ALUMINIUM

**ELECTRIFICATION**

DESCRIPTION	PRICE
Power Frame, including 4-module power strip, 28,4 cm x 7,3 cm, stainless steel, 3 m power infeed cable	5.519
Top Frame including 4-module power strip, 30,3 cm x 9,4 cm, with lid matching the tabletop, 3 m power infeed cable	16.799
Rectangular cable well, L 32,5 cm x W 13 cm, incl. cut out, aluminium (1 pcs.)	2.559
Round cable well, Ø 8,8 cm, incl. cut out, aluminium (1 pcs)	2.559
Cable tray, 65 cm, black powder coated steel	2.159
Cable hose, 78-125 cm, black or silver	2.159
Cut out for customer's own electrification solution	

\*POWER FRAME AND TOP FRAME AVAILABLE IN EU, GB, CH, KR, JP, AND CN



KS422

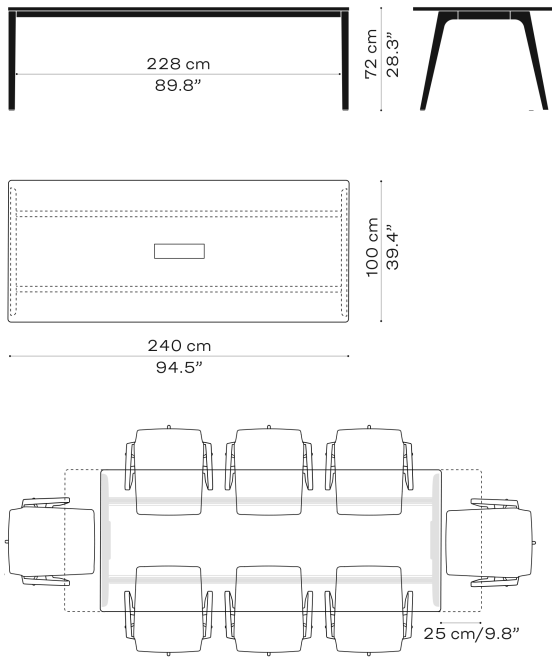

KS423

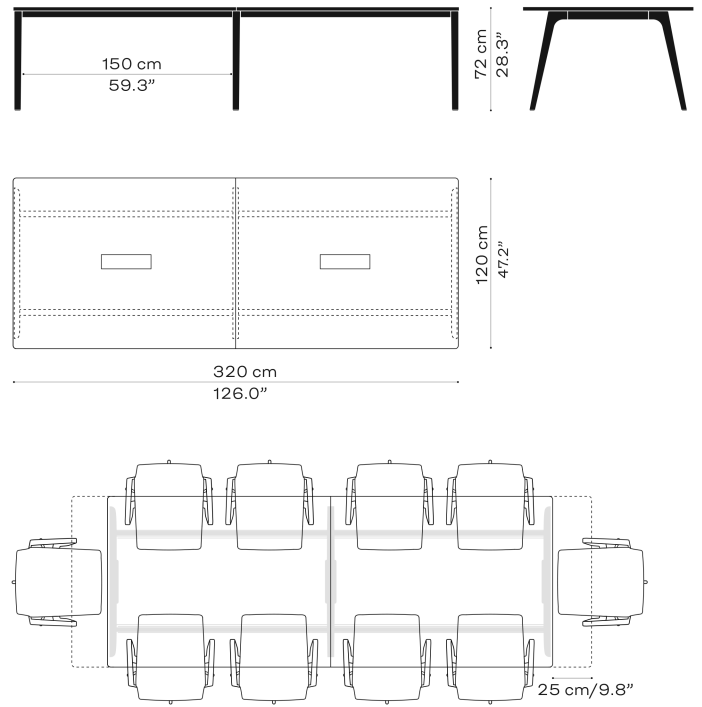

KS420

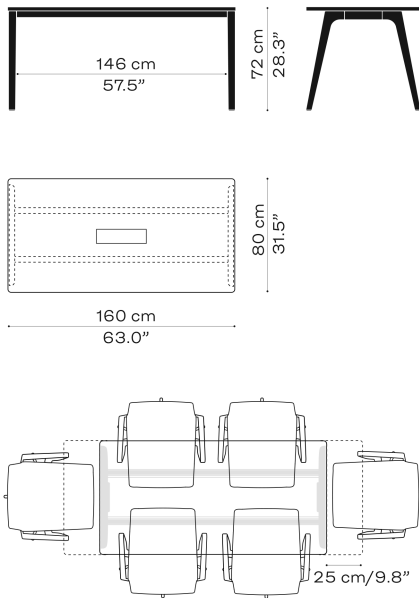

KS421

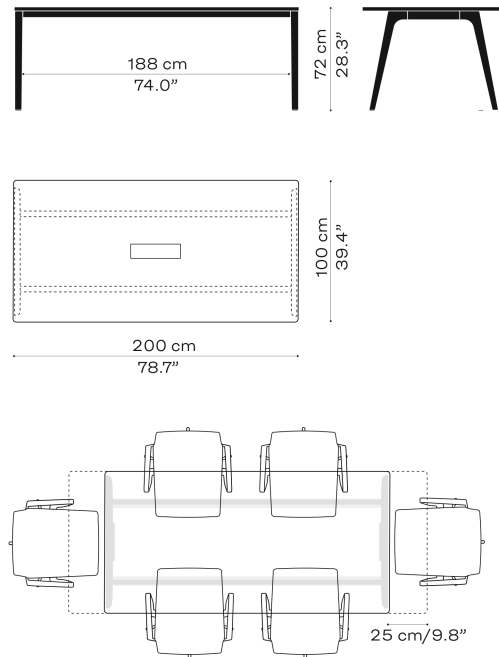





KS424

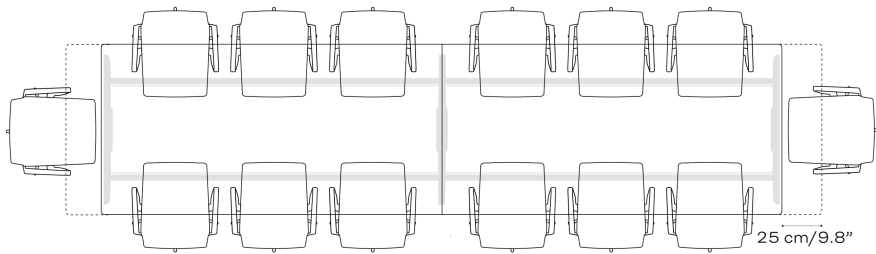
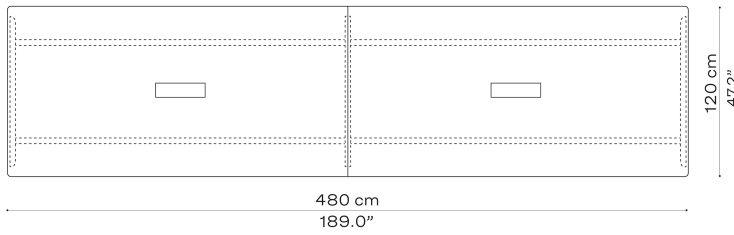

KS425

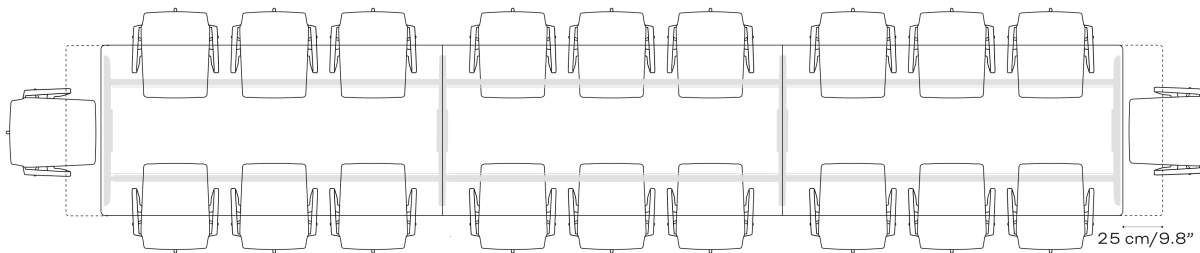
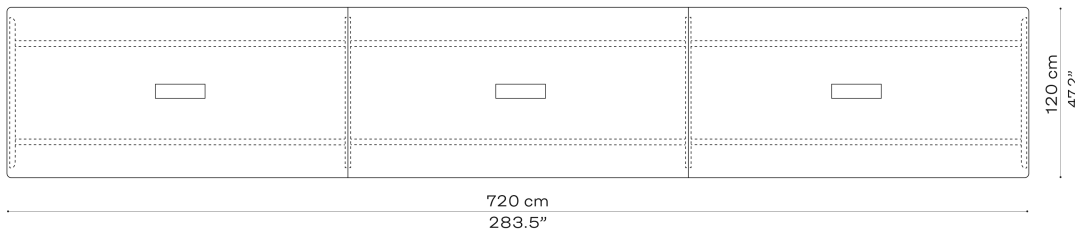

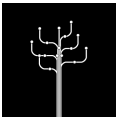

COAT TREE™ / COAT TREE™ WALL  
SIDSE WERNER 1971/2019

11.2023

The Coat Tree™ has a free standing and wall mounted variant consisting of eight or four bent steel tubes with round moulded plastic knobs.

MODEL	DESCRIPTION	PRICE
840332	Coat Tree, Chrome / Black knobs	12.799
840330	Coat Hanger, Light Grey / Grey knobs	3.759
840331	Coat Hanger, Dark Blue / Black knobs	3.759

840332

840330/840331

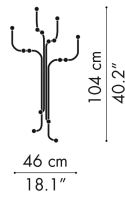
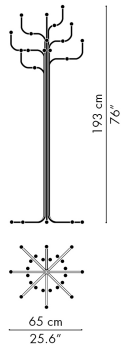



A selection of spare parts for chairs, lounge furniture and tables. Items are sold in colli unless stated otherwise.

## CHAIRS

DESCRIPTION	PRICE
Glides for Ant™, Series 7™, Grand Prix™ and Lily™, Black. 1 colli (24 pcs)	748
Glides w/felt for Ant™, Series 7™, Grand Prix™ and Lily™, Black. 1 colli (24 pcs)	748
Glides for Grand Prix™ (4130) wooden base. 1 colli (24 pcs)	460
Glides w/felt for Grand Prix™ (4130), wooden base. 1 colli (24 pcs)	748
Hard castor for soft floors with alu cap for Series 7™, no brake	191
Soft castor for hard floors with alu cap for Series 7™, no brake	191
Hard castor for soft floors with alu cap and tap for Series 7™ produced before 2003, no brake	191
Soft castor for hard floors with alu cap and tap for Series 7™ produced before 2003, no brake	191
Hard castor for soft floors with alu cap for Oxford™, no brake	191
Soft castor for hard floors with alu cap for Oxford, no brake	191
Spacer for Ant™, Series 7™, Grand Prix™, Lily™, High Dot™ & Dot™, Black or Grey rubber. 1 colli (24 pcs)	748
Cover for Ant™, Series 7™, Grand Prix™, Lily™ & Dot™ (4-legs), Black or Grey plastic. 1 colli (6 pcs)	859
Cover for Ant™ & High Dot™ (3-legs), Black or Grey plastic. 1 colli (6 pcs)	859
Chair base 4 legs, seat height 43 cm, 46 cm or 48 cm, for Ant™, Series 7™ & Grand Prix™, chromed or powder coated steel	2.399

## FERRULE / FERRULE W. FELT

## SPACER

## COVER



## CHAIR BASE

## CASTOR (SERIES 7™)

## CASTOR (OXFORD™)



## LOUNGE &amp; SOFAS

DESCRIPTION	PRICE
Glides for the Egg™, Swan™ and Swan sofa™, moulded Black polyamide. 1 colli (4 pcs)	108
Glides with felt for the Egg™, Swan™ and Swan sofa™, moulded Black polyamide. 1 colli (4 pcs)	108
Adjustment handle for the Egg™, polished stainless steel	1.519

## GLIDE

## GLIDE W. FELT

## ADJUSTMENT HANDLE

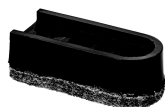



TABLES

DESCRIPTION	PRICE
Glide for span legs, transparent plastic. 1 colli (4 pcs)	284
Span legs (set of 4 pcs.), table height 70 cm (B4), without mounting plate, chromed or powder coated steel	8.799
Span legs (set of 4 pcs.), table height 72 cm (B6), without mounting plate, chromed or powder coated steel	8.799
Pedestal base 4-star, table height 47 cm (A2), satin brushed aluminium, satin chromed pedestal	9.199
Pedestal base 4-star, table height 72 cm (A6), satin brushed aluminium, satin chromed pedestal	9.199
Pedestal base, 4-star, table height 108 cm (A9), satin brushed aluminium, satin chromed pedestal	9.199
Pedestal base, 6-star, table height 72 cm (A8), satin brushed aluminium, satin chromed pedestal	19.199
Laminate cleaner for White laminate. 1 colli (6 pcs)	1.239
Cleaning sponges for laminate tabletops. 1 colli (10 pcs)	1.112
Essay™ oil kit, natural (1 pcs)	839
Essay™ oil kit, White pigmented (1 pcs)	839
Stonewash for marble tables (1 pcs)	415

SPAN LEGS	A2	A6	A8	A9
-----------	----	----	----	----

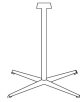

GLIDER SPAN LEGS	LAMINATE CLEANER	ESSAY OIL KIT	STONE WASH	CLEANING SPONGES
------------------	------------------	---------------	------------	------------------



# SURFACE SELECTION

# SURFACE SELECTION

## INVENTORY

- 73 • Textiles
- 78 • Leather
- 81 • Seat cushions
- 82 • Wood
- 86 • Plastic
- 87 • Laminate
  - Linoleum
  - Marble
  - Glass
- 88 • Powder coated metal
- 89 • Metal
  - Paper cord

# SURFACE SELECTION

## TEXTILES

Please note that not all textiles are suitable on all the furniture. On each individual model the standard textile options are listed. Some textiles are only available in a selection of colours.

### CUSTOMER'S OWN MATERIAL (COM)

Customers can supply their own textiles. Textile requirements, based on standard textile 130 cm wide, can be given on inquiry. We reserve the right to reject textiles that we find unsuitable for upholstery.

### CATEGORY 1

#### BELFAST (VELVET)

MATERIALS: 100% COTTON  
DURABILITY: 50.000 MARTINDALE  
COLOURS: 10

#### CANVAS

MATERIALS: 90% NEW WOOL (WORSTED), 10% NYLON  
DURABILITY: 100.000 MARTINDALE  
AVAILABLE IN ALL COLOURS

#### CAPTURE

MATERIALS: 85% WOOL, 15% POLYAMIDE  
DURABILITY: 200.000 MARTINDALE  
AVAILABLE IN ALL COLOURS

#### DIABLO

MATERIALS: 54% VISCOSE, 46% COTTON  
DURABILITY: >30.000 MARTINDALE  
AVAILABLE IN ALL COLOURS

#### FAME

MATERIALS: 95% WOOL, 5% POLYAMID  
DURABILITY: 200.000 MARTINDALE  
AVAILABLE IN ALL COLOURS

#### LINARA

MATERIALS: 63% COTTON, 37% LINEN  
DURABILITY: 36.000 MARTINDALE  
COLOURS: 6

#### REMIX

MATERIALS: 90% NEW WOOL (WORSTED) 10% NYLON  
DURABILITY: 100.000 MARTINDALE  
AVAILABLE IN ALL COLOURS

#### TONUS

MATERIALS: 90% NEW WOOL, 10% HELANCA  
DURABILITY: 100.000 MARTINDALE  
AVAILABLE IN ALL COLOURS

### CATEGORY 2

#### CLAY

MATERIALS: 76% LINEN, 21% COTTON,  
3% POLYESTER  
DURABILITY: 45.000 MARTINDALE  
COLOURS: 6

#### DIVINA

MATERIALS: 100% NEW WOOL  
DURABILITY: 45.000 MARTINDALE  
AVAILABLE IN ALL COLOURS

#### DIVINA MD

MATERIALS: 100% NEW WOOL  
DURABILITY: 45.000 MARTINDALE  
AVAILABLE IN ALL COLOURS

#### DIVINA MELANGE

MATERIALS: 100% NEW WOOL  
DURABILITY: 45.000 MARTINDALE  
AVAILABLE IN ALL COLOURS

#### FIORD

MATERIALS: 92% NEW WOOL (WORSTED), 8% NYLON  
DURABILITY: 60.000 MARTINDALE  
AVAILABLE IN ALL COLOURS

#### HALLINGDAL

MATERIALS: 70% NEW WOOL, 30% VISCOSE  
DURABILITY: 100.000 MARTINDALE  
AVAILABLE IN ALL COLOURS

#### HARALD (VELVET)

MATERIALS: 100% COTTON  
DURABILITY: 100.000 MARTINDALE  
AVAILABLE IN ALL COLOURS

#### KARAKORUM

MATERIALS: 42% WOOL, 33% VISCOSE, 24% COTTON,  
1% POLYAMIDE  
DURABILITY: 40.000 MARTINDALE  
AVAILABLE IN ALL COLOURS

#### MOSS

MATERIALS: 52% COTTON, 22% VISCOSE,  
14% POLYACRYLIC, 6% LINEN, 3% POLYESTER,  
3% NYLON  
DURABILITY: 50.000 MARTINDALE  
COLOURS: 6

#### NABIS

MATERIALS: 48% COTTON, 30% VISCOSE,  
22% POLYESTER  
DURABILITY: 40.000 MARTINDALE  
COLOURS: 2

#### RE-WOOL

MATERIALS: 45% RECYCLED WOOL, 45% NEW WOOL  
(WORSTED), 10% NYLON  
DURABILITY: 100.000 MARTINDALE  
AVAILABLE IN ALL COLOURS

#### STEELCUT

MATERIALS: 90% NEW WOOL (WORSTED) 10% NYLON  
DURABILITY: 100.000 MARTINDALE  
AVAILABLE IN ALL COLOURS

#### STEELCUT TRIO

MATERIALS: 90% NEW WOOL (WORSTED) 10% NYLON  
DURABILITY: 100.000 MARTINDALE  
AVAILABLE IN ALL COLOURS

#### SUNNIVA

MATERIALS: 58% NEW WOOL, 25% VISCOSE, 8% LINEN,  
5% NYLON, 4% POLYESTER  
DURABILITY: 50.000 MARTINDALE  
AVAILABLE IN ALL COLOURS

#### TWILL WEAVE

MATERIALS: 90% NEW WOOL (WORSTED), 10% NYLON  
DURABILITY: 60.000 MARTINDALE  
AVAILABLE IN ALL COLOURS

#### VANIR

MATERIALS: 92% NEW WOOL (WORSTED), 8% NYLON  
DURABILITY: 100.000 MARTINDALE  
COLOURS: 12

#### VIDAR

MATERIALS: 94% NEW WOOL, 6% NYLON  
DURABILITY: 100.000 MARTINDALE  
AVAILABLE IN ALL COLOURS

### CATEGORY 3

#### COMFORT

MATERIALS: 88% POLYESTER, 12% NYLON  
DURABILITY: 150.000 MARTINDALE  
AVAILABLE IN ALL COLOURS

#### SONAR

MATERIALS: 59% NEW WOOL, 25% VISCOSE,  
9% LINEN, 5% NYLON, 2% POLYESTER  
DURABILITY: 20.000 MARTINDALE  
AVAILABLE IN ALL COLOURS

### CATEGORY 4

#### ATOM

MATERIALS: 90% NEW WOOL (WORSTED),  
8% NYLON, 2% POLYESTER  
DURABILITY: 65.000 MARTINDALE  
COLOURS: 2

#### RIA

MATERIALS: 84% NEW WOOL (WORSTED),  
12% VISCOSE, 4% NYLON  
DURABILITY: 50.000 MARTINDALE  
AVAILABLE IN ALL COLOURS

### MISCELLANEOUS

#### JUST

MATERIALS: 98% POST-CONSUMER RECYCLED  
POLYESTER / 2% POLYESTER  
DURABILITY: 70.000 MARTINDALE

#### SALSA

MATERIALS: 100% POLYESTER  
DURABILITY: 200.000 MARTINDALE

# SURFACE SELECTION

## TEXTILES

	ATOM	BELFAST	CANVAS	CAPTURE	CHRISTIANSHAVN	CLAY	COMFORT	DIABLO	DIVINA	DIVINA MELANGE	DIVINA MD	FAME	FIORD	HALLINGDAL	HARALD	JUST	KARAKORUM	LINARA	MOSS	NABIS	REMIX	RE-WOOL	RIA	SALSA	SONAR	STEELCUT	STEELCUT TRIO	SUNNIVA	TONUS	TWILL WEAVE	VANIR	VIDAR	
ALPHABET™ SOFA SERIES			●	●	●		●	●	●	●	●	●	●			●					●	●				●	●	●	●				
ANT™ FRONT		●	●	●	●		●	●	●	●	●	●	●									●	●			●	●	●	●			●	●
CHINA CHAIR™																																	
DOT™																								●									
DROP™			●	●	●		●	●	●	●	●	●	●									●	●			●	●	●	●				
DROP™ SEAT CUSHION																								●									
EGG™			●	●	●		●	●	●	●	●	●	●										●			●	●	●	●				
FAVN™ SHELL/BASE				●	●			●	●	●	●	●	●										●			●	●	●	●				
FAVN™ SEAT/BACK			●	●	●		●	●	●	●	●	●	●									●	●			●	●	●	●				
FAVN™ CUSHIONS			●	●	●		●	●	●	●	●	●	●									●	●			●	●	●	●				
FRED™		●			●									●	●								●	●									
FRI™	●		●	●	●			●	●	●	●	●	●									●	●			●	●	●	●				●
FRI™ FOOTSTOOL	●		●	●	●			●	●	●	●	●	●									●	●			●	●	●	●				●
GRAND PRIX™ FRONT			●	●	●		●	●	●	●	●	●	●									●	●			●	●	●	●			●	
GRAND PRIX™ FULL			●	●	●		●	●	●	●	●	●	●									●	●			●	●	●	●			●	
LET™			●		●			●	●	●	●	●	●									●	●			●	●	●	●				●
LILY™			●	●	●		●	●	●	●	●	●	●									●	●			●	●	●	●			●	
LITTLE GIRAFFE™			●	●	●		●	●	●	●	●	●	●									●	●			●	●	●	●				
LITTLE GIRAFFE™ REMOVABLE COVER			●	●	●		●	●	●	●	●	●	●									●	●			●	●	●	●				
LISSONI SOFA™			●	●	●	●	●	●	●	●	●	●	●					●				●	●			●	●	●	●				
LUNE™			●	●	●		●	●	●	●	●	●	●					●				●	●			●	●	●	●				
N01™ SEAT CUSHION																						●											
N02™ RECYCLE SEAT CUSHION																●																	
NAP™ SEAT CUSHION									●																								
OXFORD™			●	●	●		●	●	●	●	●	●	●									●	●		●	●	●	●	●				●
PLENUM™			●	●	●			●	●	●	●	●	●									●	●			●	●	●	●				
POT™			●	●	●		●	●	●	●	●	●	●									●	●			●	●	●	●				
RO™ SHELL	●			●	●			●	●	●	●	●	●										●			●	●	●	●	●			●
RO™ CUSHIONS	●		●	●	●		●	●	●	●	●	●	●							●	●	●				●	●	●	●	●			●
RO™ FOOTSTOOL	●		●	●	●		●	●	●	●	●	●	●								●	●	●			●	●	●	●	●			●
RO™ SOFA SHELL				●	●			●	●	●	●	●	●										●			●	●	●	●				
RO™ SOFA CUSHIONS			●	●	●		●	●	●	●	●	●	●									●	●			●	●	●	●				
SERIES 7™ FRONT		●	●	●	●		●	●	●	●	●	●	●									●	●			●	●	●	●			●	
SERIES 7™ FULL		●	●	●	●		●	●	●	●	●	●	●									●	●			●	●	●	●			●	
SERIES 3300™			●	●	●		●	●	●	●	●	●	●									●	●			●	●	●	●				
SWAN™				●	●		●	●	●	●	●	●	●										●			●	●	●	●				
SWAN SOFA™				●	●		●	●	●	●	●	●	●										●			●	●	●	●				
VIA57™				●	●			●	●	●		●	●										●			●	●	●	●				
VICO DUO™ FRONT		●	●	●	●		●	●	●	●	●	●	●									●	●			●	●	●	●				
VICO DUO™ FULL		●	●	●	●		●	●	●	●	●	●	●									●	●			●	●	●	●				
VICO DUO™ SEAT CUSHION																●																	



# SURFACE SELECTION

Colours and materials may vary from the images shown.  
Actual colour, gloss level and structure may vary.

## TEXTILES

### CHRISTIANSHAVN™



Alphabet™ Sofa Series  
Ant™  
Drop™  
Egg™  
Favn™  
Fred™  
Fri™  
Grand Prix™  
Let™  
Lily™  
Lissoni Sofa™  
Little Giraffe™  
Lune™  
Oxford™  
Plenum™  
Pot™  
Ro™  
Ro™ Sofa  
Series 7™  
Series 3300™  
Swan™  
Swan Sofa™  
VIA57™  
Vico Duo™

MATERIALS: 85% WOOL, 15% POLYAMID  
DURABILITY: 200.000 MARTINDALE  
LIGHT FASTNESS: 5-7  
COLOURS: 26

Christianshavn™ is a timeless, wool mix textile designed by Fritz Hansen. Its 26 contemporary colours offer an immense variety in both unicolour and melange weave. It has superior comfort due to the wool mix and with its high durability and a 200.000 rubs martindale, it is suitable for all upholstered products in the Fritz Hansen collection. The name; Christianshavn leads back to where it all started. The young enterprising cabinet-maker Fritz Hansen started his furniture production company in Christianshavn - a central part of Copenhagen. Christianshavn can be used in private interiors as well as public areas.

## DESIGNER SELECTION COLOURS

### FRI™

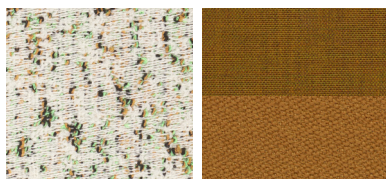

**ATOM WHITE**  
Shell: Atom 0124  
Cushions: Atom 0124

**BURNT YELLOW**  
Shell: Remix 422  
Cushions: Vidar 472

### RO™

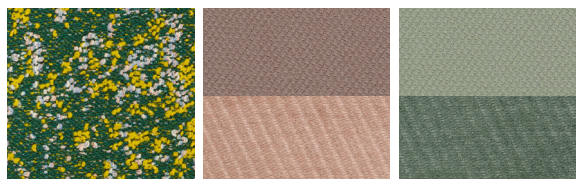

**ATOM GREEN**  
Shell: Atom 0964  
Cushions: Atom 0964

**PALE ROSE**  
Shell: Steelcut 605  
Cushions: Nabis 0011

**MINT GREEN**  
Shell: Steelcut 935  
Cushions: Nabis 0023

# SURFACE SELECTION

Colours and materials may vary from the images shown.  
Actual colour, gloss level and structure may vary.

## SELECTED TEXTILE COLOURS

### BELFAST (VELVET)



**FOREST GREEN**  
770660  
Ant™  
Fred™  
Series 7™  
Vico Duo™

**MISTY ROSE**  
770593  
Ant™  
Fred™  
Series 7™  
Vico Duo™

**NIGHT BLACK**  
772150  
Ant™  
Fred™  
Series 7™  
Vico Duo™

**DARK PLUM**  
774232  
Ant™  
Fred™  
Series 7™  
Vico Duo™

**SEAL GREY**  
775139  
Ant™  
Fred™  
Series 7™  
Vico Duo™

**SOFT OCHRE**  
774926  
Ant™  
Fred™  
Series 7™  
Vico Duo™

**GREY BROWN**  
771772  
Ant™  
Fred™  
Series 7™  
Vico Duo™



**AUTUMN RED**  
772255  
Ant™  
Fred™  
Series 7™  
Vico Duo™

**GREY BLUE**  
772143  
Ant™  
Fred™  
Series 7™  
Vico Duo™

**MIDNIGHT BLUE**  
772062  
Ant™  
Fred™  
Series 7™  
Vico Duo™

### CLAY

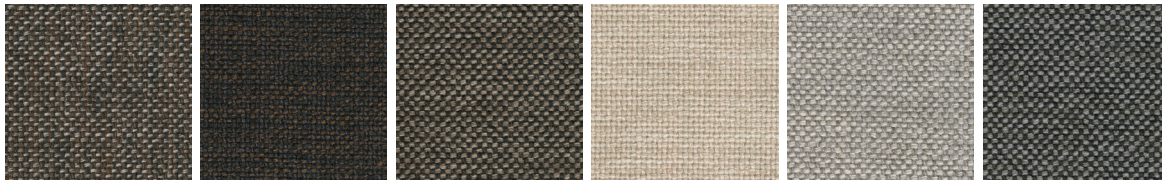

**BROWN**  
0004  
Lissoni Sofa™

**DARK BROWN**  
0005  
Lissoni Sofa™

**DARK SAND**  
0008  
Lissoni Sofa™

**BEIGE**  
0011  
Lissoni Sofa™

**LIGHT GREY**  
0012  
Lissoni Sofa™

**GREY**  
0013  
Lissoni Sofa™

### LINARA



**BLUEBERRY**  
2494/198  
Lune™

**EUCALYPTUS**  
2494/324  
Lune™

**GINGERSNAP**  
2494/118  
Lune™

**GREY MIST**  
2494/340  
Lune™

**INDIGO**  
2494/30  
Lune™

**LEAD**  
2494/237  
Lune™

### MOSS



**BEIGE**  
0004  
Lissoni Sofa™

**LIGHT GREY**  
0005  
Lissoni Sofa™

**GREY**  
0006  
Lissoni Sofa™

**SAND/GREY**  
0011  
Lissoni Sofa™

**DARK CLAY**  
0014  
Lissoni Sofa™

**CLAY**  
0015  
Lissoni Sofa™

# SURFACE SELECTION

Colours and materials may vary from the images shown.  
Actual colour, gloss level and structure may vary.

## SELECTED TEXTILE COLOURS

### VANIR

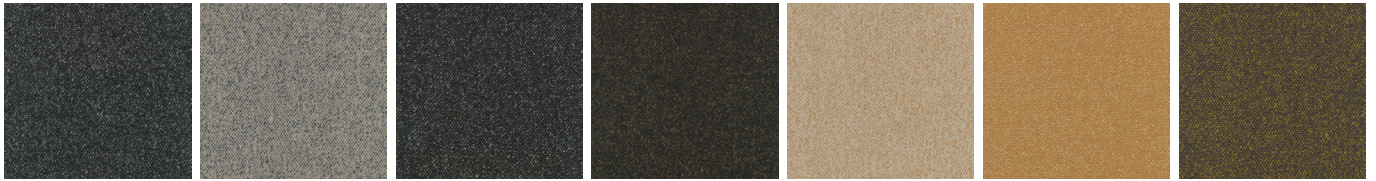

**BLACK/GREY**  
193  
Ant™  
Grand Prix™  
Lily™  
Series 7™

**SAND/BLUE**  
243  
Ant™  
Grand Prix™  
Lily™  
Series 7™

**GRANITE BROWN**  
373  
Ant™  
Grand Prix™  
Lily™  
Series 7™

**BLACK/MUSTARD**  
393  
Ant™  
Grand Prix™  
Lily™  
Series 7™

**BEIGE MUSTARD**  
413  
Ant™  
Grand Prix™  
Lily™  
Series 7™

**CORN YELLOW**  
443  
Ant™  
Grand Prix™  
Lily™  
Series 7™

**PURPLE/YELLOW**  
473  
Ant™  
Grand Prix™  
Lily™  
Series 7™

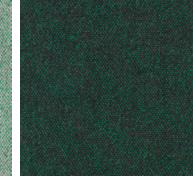
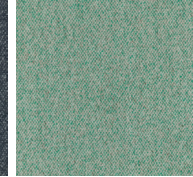
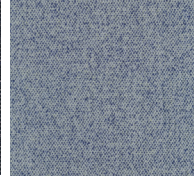

**DARK PURPLE**  
693  
Ant™  
Grand Prix™  
Lily™  
Series 7™

**LIGHT BLUE**  
733  
Ant™  
Grand Prix™  
Lily™  
Series 7™

**DUSTY BLUE**  
773  
Ant™  
Grand Prix™  
Lily™  
Series 7™

**LIGHT EMERALD GREEN**  
913  
Ant™  
Grand Prix™  
Lily™  
Series 7™

**DARK EMERALD GREEN**  
983  
Ant™  
Grand Prix™  
Lily™  
Series 7™

# SURFACE SELECTION

## LEATHER

Please note that leather is a natural material with natural variation in colour and surface structure. The presence of scars and marks from bites etc. on the leather may occur and are characteristics of genuine leather.

Further information about materials, care and maintenance can be found on [www.fritzhanzen.com](http://www.fritzhanzen.com).

### CUSTOMER'S OWN LEATHER (COL)

Customers can supply their own leather. Prices excluding leather as well as leather requirements can be given on inquiry. Please note that only very few types of leather/qualities are suitable. Fritz Hansen retains the right to reject the qualities we find unsuitable.

### SPECIAL LEATHER COLOURS

On inquiry and at a surcharge, special leather colours may be available for the models available with leather upholstery.

	AURA	BUFFED	EMBRACE	ESSENTIAL	GRACE	INTENSE	NATURAL	RAW	RUSTIK	SOFT	WILD
ANT™ FRONT			●	●	●		●			●	
CHINA CHAIR™	●		●		●		●		●		
DOT™		●				●					●
DROP™	●		●	●	●		●		●		
EGG™	●		●	●	●		●		●		
FRED™				●							
GRAND PRIX™ FRONT			●	●	●		●			●	
GRAND PRIX™ FULL			●	●	●		●		●	●	
HIGH DOT™		●				●					●
LET™				●							
LILY™			●	●	●		●		●	●	
LITTLE GIRAFFE™	●		●	●	●		●		●		
LISSONI SOFA™			●	●	●		●		●	●	
LUNE™	●		●							●	
NO1™ SEAT CUSHION								●			
OKSEN™	●			●	●						
OXFORD™			●	●	●		●		●	●	
POT™	●		●	●	●		●		●		
SERIES 7™ FRONT			●	●	●		●			●	
SERIES 7™ FULL			●	●	●		●		●	●	
SERIES 7™ SEAT CUSHION						●		●			●
SERIES 3300™	●		●	●	●		●		●		
SWAN™	●		●	●	●		●		●		
SWAN SOFA™	●		●	●	●		●		●		
VICO DUO™ FRONT			●	●	●		●			●	
VICO DUO™ FULL			●	●	●		●		●	●	

# SURFACE SELECTION

Colours and materials may vary from the images shown.  
Actual colour, gloss level and structure may vary.

## LEATHER

### AURA

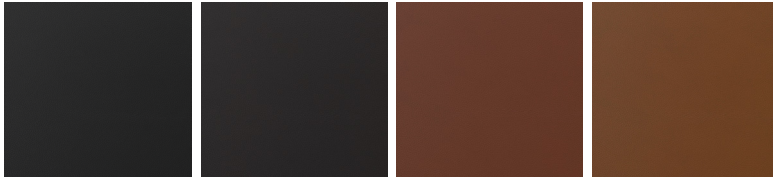

BLACK

China Chair™  
Drop™  
Egg™  
Little Giraffe™  
Lune™  
Oksen™  
Pot™  
Series 3300™  
Swan™  
Swan Sofa™

BLACK BROWN

**CATEGORY: 4**  
Chrome-tanned, top-coated, strong  
full-grain and durable surface.

Thickness 1.4-1.6 mm.

COGNAC

WALNUT

### EMBRACE

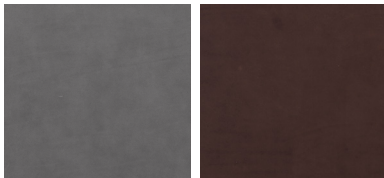

CONCRETE GREY

Ant™  
China Chair™  
Drop™  
Egg™  
Grand Prix™  
Lily™  
Little Giraffe™  
Lissoni Sofa™  
Lune™  
Oxford™  
Pot™  
Series 7™  
Series 3300™  
Swan™  
Swan Sofa™  
Vico Duo™

CHOCOLATE

**CATEGORY: 5**  
Chrome-tanned, fully grained,  
extraordinary soft aniline with a special  
waxing giving a slightly 'oily' surface.  
Colour variations, visible natural  
markings e.g. Neck wrinkles.

Thickness 1.2-1.4 mm.

### ESSENTIAL

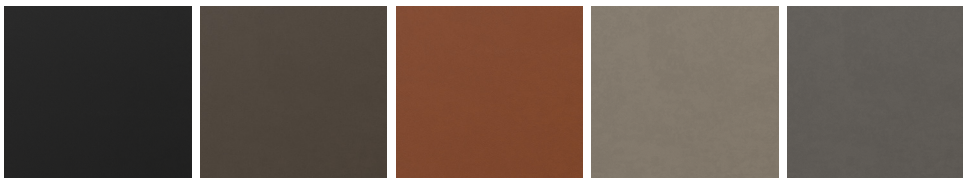

BLACK

Ant™  
Drop™  
Egg™  
Fred™  
Grand Prix™  
Let™  
Lily™  
Little Giraffe™  
Lissoni Sofa™  
Oksen™  
Oxford™  
Pot™  
Series 7™  
Series 3300™  
Swan™  
Swan Sofa™  
Vico Duo™

STONE

**CATEGORY: 3**  
Chrome-tanned, lightly polished,  
top-coated and grain printed durable  
surface.

Thickness 1.0-1.2 mm.

WALNUT

LIGHT GREY

LAVA

# SURFACE SELECTION

Colours and materials may vary from the images shown.  
Actual colour, gloss level and structure may vary.

## LEATHER

### GRACE



#### BLACK

Ant™  
China Chair™  
Drop™  
Egg™  
Grand Prix™  
Lily™  
Little Giraffe™  
Lissoni Sofa™  
Oksen™  
Oxford™  
Pot™  
Series 7™  
Series 3300™  
Swan™  
Swan Sofa™  
Vico Duo™

#### DARK BROWN

**CATEGORY: 5**  
Vegetable and chrome-tanned, aniline, full-grain with light structure and light impregnation. Becomes lighter and patinated with use, visible natural markings.

Thickness 1.2-1.4 mm.

#### WALNUT

#### CHESTNUT

### NATURAL



#### NATURAL

Ant™  
China Chair™  
Drop™  
Egg™  
Grand Prix™  
Lily™  
Little Giraffe™  
Lissoni Sofa™  
Oxford™  
Pot™  
Series 7™  
Series 3300™  
Swan™  
Swan Sofa™  
Vico Duo™

#### CATEGORY: 5

Vegetable-tanned, chrome-free, natural leather, no colour or protective finish. Becomes darker and patinated with use, visible natural markings.

Thickness 1.2-1.4 mm.

### RUSTIK



#### RUSTIK

China Chair™  
Drop™  
Egg™  
Grand Prix™  
Lily™  
Little Giraffe™  
Lissoni Sofa™  
Oxford™  
Pot™  
Series 7™  
Series 3300™  
Swan™  
Swan Sofa™  
Vico Duo™

#### CATEGORY: 5

Vegetable-tanned, chrome-free, aniline, no protective finish, light impregnation, visible natural marks. Becomes lighter and patinated with use.

Thickness 1.2-1.4 mm.

### SOFT



#### BLACK

Ant™  
Grand Prix™  
Lily™  
Lissoni Sofa™  
Little Giraffe™  
Lune™  
Oxford™  
Series 7™  
Vico Duo™

#### BLACK BROWN

#### CATEGORY: 4

Chrome-tanned, semi-aniline, full-grain with light structure and surface finish.

Thickness 1.0-1.2 mm.

#### COGNAC

#### WALNUT

# SURFACE SELECTION

Colours and materials may vary from the images shown.  
Actual colour, gloss level and structure may vary.

## SEAT CUSHIONS

### DROP™ (3110SC)



GREY  
TEXTILE  
SALSA 3/36

BLACK  
TEXTILE  
SALSA 3/39

### NAP™ (KS70)

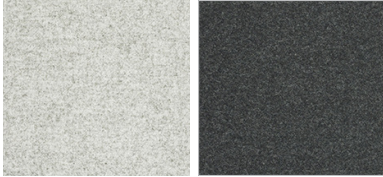

LIGHT GREY  
TEXTILE  
DIVINA MELANGE 120

DARK GREY  
TEXTILE  
DIVINA MELANGE 180

### NO1™ (N70/N71)



DARK BLUE/GREY  
TEXTILE  
REMIX 173

BEIGE  
TEXTILE  
REMIX 233

DARK BROWN  
TEXTILE  
REMIX 393

BLACK  
LEATHER  
RAW

### NO2™ RECYCLE (N02-70)

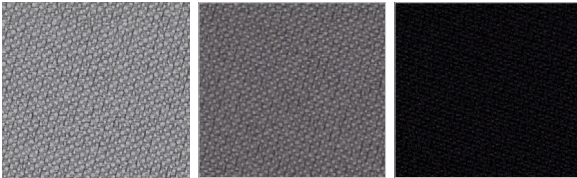

LIGHT GREY  
TEXTILE  
JUST 60118

DARK GREY  
TEXTILE  
JUST 60121

BLACK  
TEXTILE  
JUST 60999

### SERIES 7™ (3107SC)

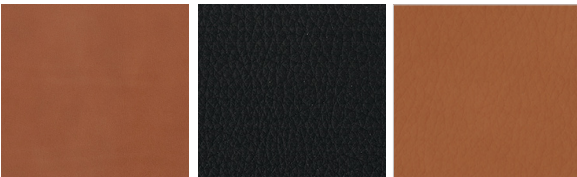

WALNUT  
LEATHER  
WILD

BLACK  
LEATHER  
RAW

BROWN  
LEATHER  
INTENSE

### VICO DUO™ (VM170)

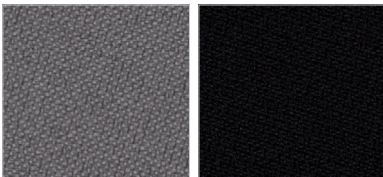

DARK GREY  
TEXTILE  
JUST 60121

BLACK  
TEXTILE  
JUST 60999

# SURFACE SELECTION

Colours and materials may vary from the images shown.  
Actual colour, gloss level and structure may vary.

## COLOURED VENEER

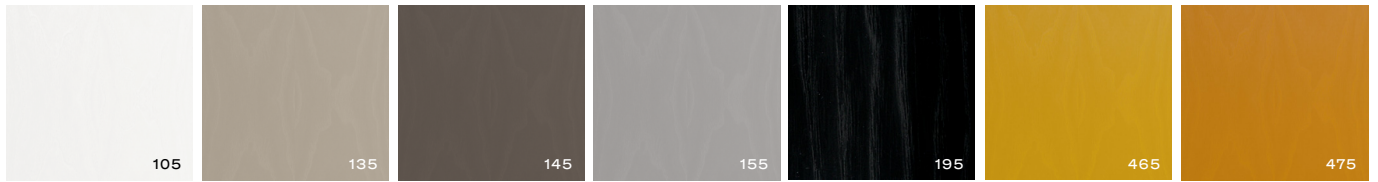

ASH - WHITE

Ant™  
Grand Prix™  
Series 7™

ASH - LIGHT BEIGE

Ant™  
Grand Prix™  
Series 7™

ASH - DEEP CLAY

Ant™  
Grand Prix™  
Series 7™

ASH - NINE GREY

Ant™  
Grand Prix™  
Series 7™

ASH - BLACK

AJ Trolley™  
Ant™  
Dot™  
FH3605™  
High Dot™  
Grand Prix™  
Series 7™  
Series 7™ Junior  
Stub™  
Vico Duo™

ASH - TRUE YELLOW

Ant™  
Grand Prix™  
Series 7™

ASH - BURNT YELLOW

Ant™  
Grand Prix™  
Series 7™  
Series 7™ Junior

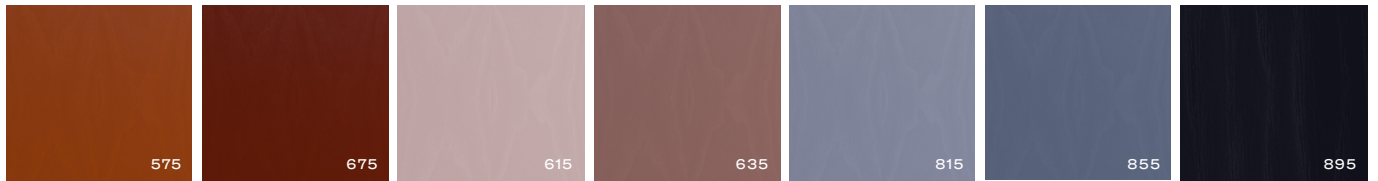

ASH - PARADISE ORANGE

Ant™  
Grand Prix™  
Series 7™

ASH - VENETIAN RED

Ant™  
Grand Prix™  
Series 7™

ASH - PALE ROSE

Ant™  
Grand Prix™  
Series 7™

ASH - WILD ROSE

Ant™  
Children's Chairs  
Grand Prix™  
Series 7™

ASH - LAVENDER BLUE

Ant™  
Grand Prix™  
Series 7™

ASH - DUSK BLUE

Ant™  
Grand Prix™  
Series 7™

ASH - MIDNIGHT BLUE

Ant™  
Children's Chairs  
Grand Prix™  
Series 7™

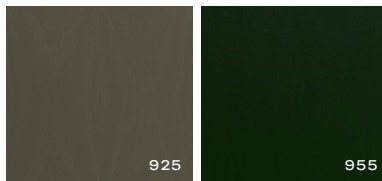

ASH - OLIVE GREEN

Ant™  
Grand Prix™  
Series 7™

ASH - EVERGREEN

Ant™  
Grand Prix™  
Series 7™  
Series 7™ Junior

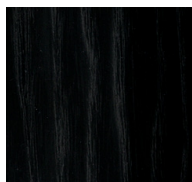

OAK - BLACK

NO1™



# SURFACE SELECTION

Colours and materials may vary from the images shown.  
Actual colour, gloss level and structure may vary.

## LACQUERED VENEER

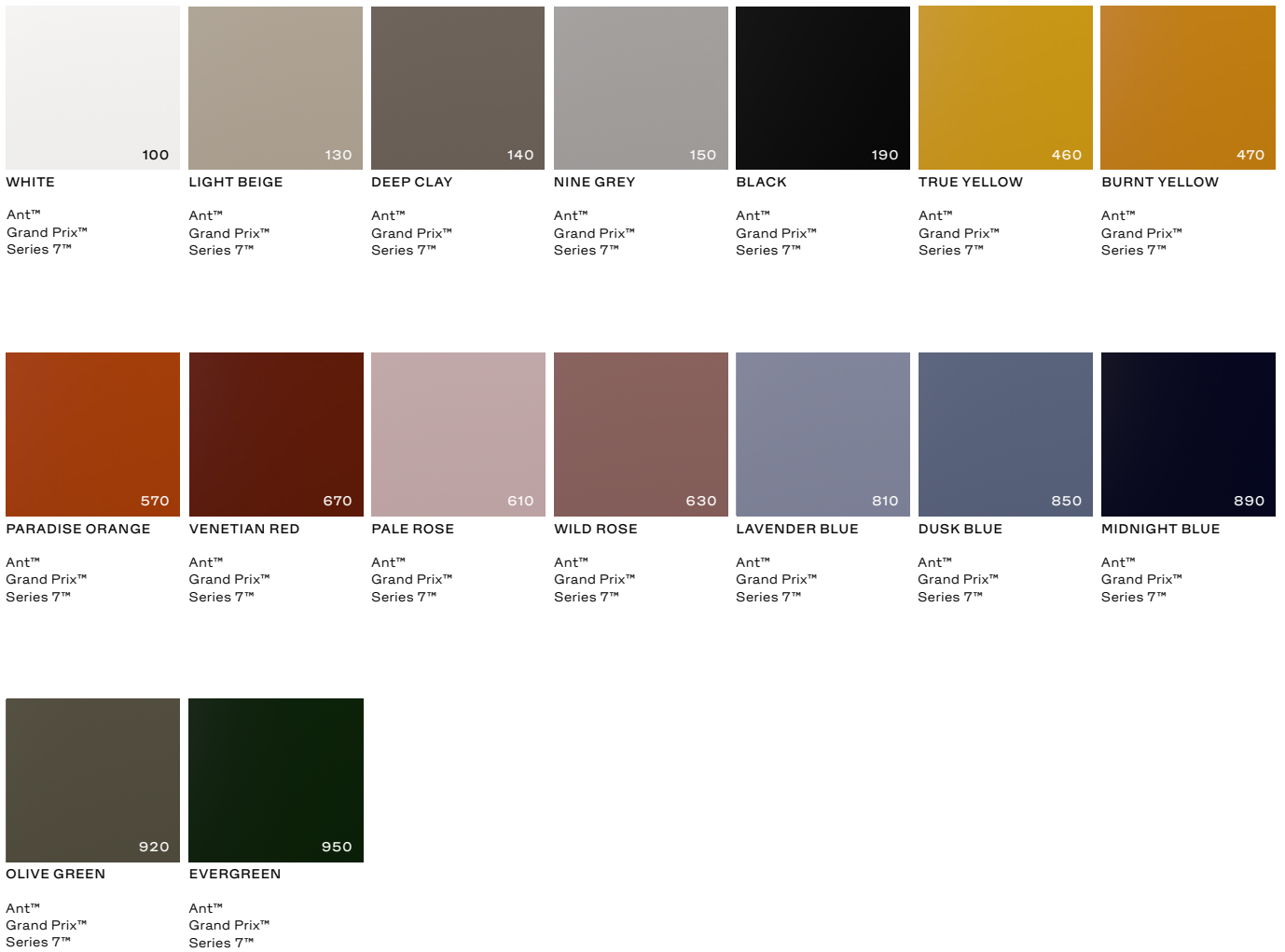

# SURFACE SELECTION

Colours and materials may vary from the images shown.  
Actual colour, gloss level and structure may vary.

## CLEAR LACQUERED VENEER



MAPLE

Ant™  
Series 7™



BEECH

Ant™  
N01™  
Series 7™



ASH

Ant™  
Series 7™  
Stub™



CHERRY

Ant™  
Series 7™



OREGON PINE

Ant™  
Children's Chairs  
Series 7™



ELM

Ant™  
Series 7™



OAK

Analog™  
Ant™  
Grand Prix™  
N01™  
NAP™ (base)  
Planner™ Shelving  
Pluralis™  
Series 7™  
Series 7™ Junior  
Stub™  
Vico Duo™



WALNUT

Analog™  
Ant™  
Circular  
Dot™  
Egg™ Table  
FH3605™  
Grand Prix™  
High Dot™  
Lily™  
Pluralis™  
Rectangular  
Series 7™  
Supercircular™  
Superellipse™  
Vico Duo™



OAK - DARK STAINED/  
FULL DARK STAINED

Ant™  
Series 7™

# SURFACE SELECTION

Colours and materials may vary from the images shown.  
Actual colour, gloss level and structure may vary.

## CLEAR LACQUERED SOLID WOOD



BEECH

ASH

CHERRY

OAK

OAK - WALNUT STAINED

WALNUT

N01™

Let™

China Chair™

Analog™ (base)  
Fred™  
Fri™  
Join™  
Let™  
Lune™  
N01™  
Ro™  
Ro™ Sofa  
VIA57™

Fred™

Analog™ (base)  
FH3605™ (drawer)

## OILED SOLID WOOD



CHERRY - NATURAL

OAK - NATURAL

OAK - WHITE PIGMENTED

PINE - NATURAL

Taburet

Fred™  
Essay™

Essay™

Taburet

## UNTREATED SOLID WOOD

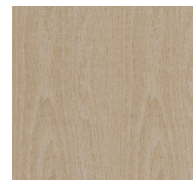

BEECH

Carimate™

## COLOURED SOLID WOOD



ASH - BLACK

OAK - BLACK

Carimate™  
China Chair™  
FH3605™ (drawer)  
Fred™  
Let™

Analog™ (base)  
Join™  
Lune™  
N01™

# SURFACE SELECTION

Colours and materials may vary from the images shown.  
Actual colour, gloss level and structure may vary.

## PLASTIC (ABS)

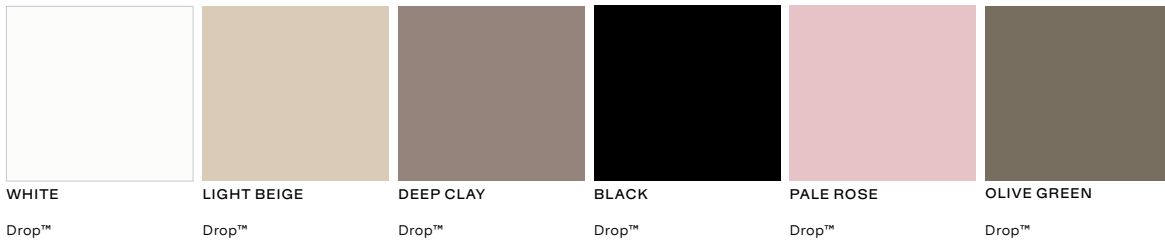

## PLASTIC (PA)

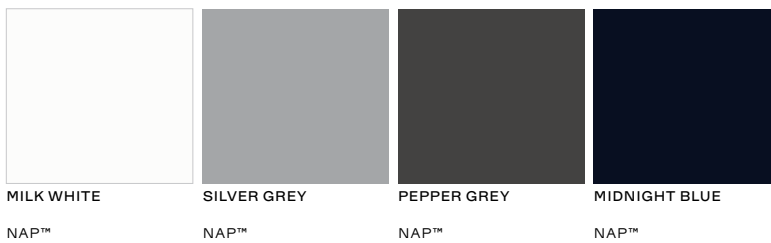

## RECYCLED PLASTIC (PP)

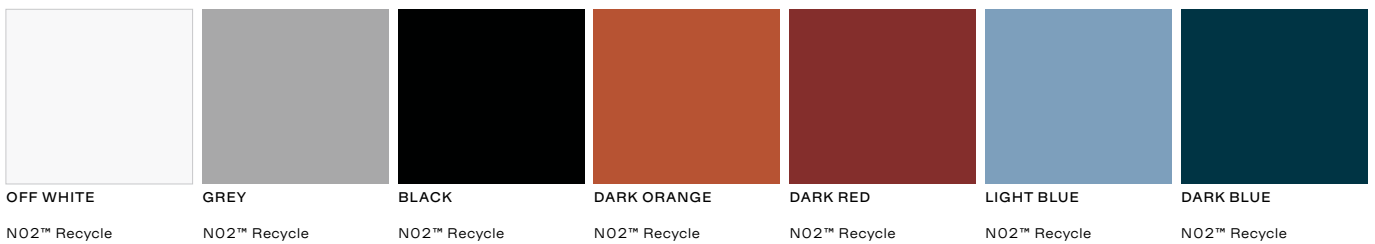

# SURFACE SELECTION

Colours and materials may vary from the images shown.  
Actual colour, gloss level and structure may vary.

## LAMINATE (FENIX)

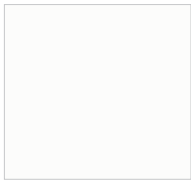

WHITE

Circular  
Rectangular  
Supercircular™  
Superellipse™

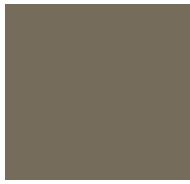

BROWN OTTAWA

Circular  
Rectangular  
Supercircular™  
Superellipse™



GREY

Circular  
Rectangular  
Supercircular™  
Superellipse™



GREY BROMO

Circular  
Rectangular  
Supercircular™  
Superellipse™



GREY EFESO

Circular  
Rectangular  
Supercircular™  
Superellipse™



BLACK

Circular  
Essay™ (extension leaf)  
Rectangular  
Supercircular™  
Superellipse™

## LAMINATE (POLYREY)



WHITE

Pluralis™



LIGHT GREY

Plenum™



LAVA GREY

Pluralis™

## LAMINATE (PFLEIDERER)



WHITE

Analog™

## COMPACT LAMINATE

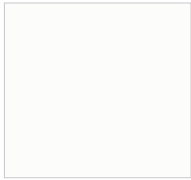

WHITE

Little Friend™



BLACK

Little Friend™



OAK

Little Friend™



WALNUT

Little Friend™

## LINOLEUM

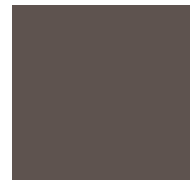

MAUVE BROWN

Pluralis™

## HONED MARBLE



CREAM

Planner™ Table Series

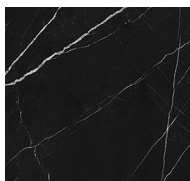

CHARCOAL

Planner™ Table Series

## GLASS

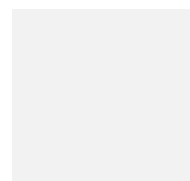

CLEAR

Stub™

# SURFACE SELECTION

Colours and materials may vary from the images shown.  
Actual colour, gloss level and structure may vary.

## POWDER COATED METAL (STEEL OR ALUMINIUM)

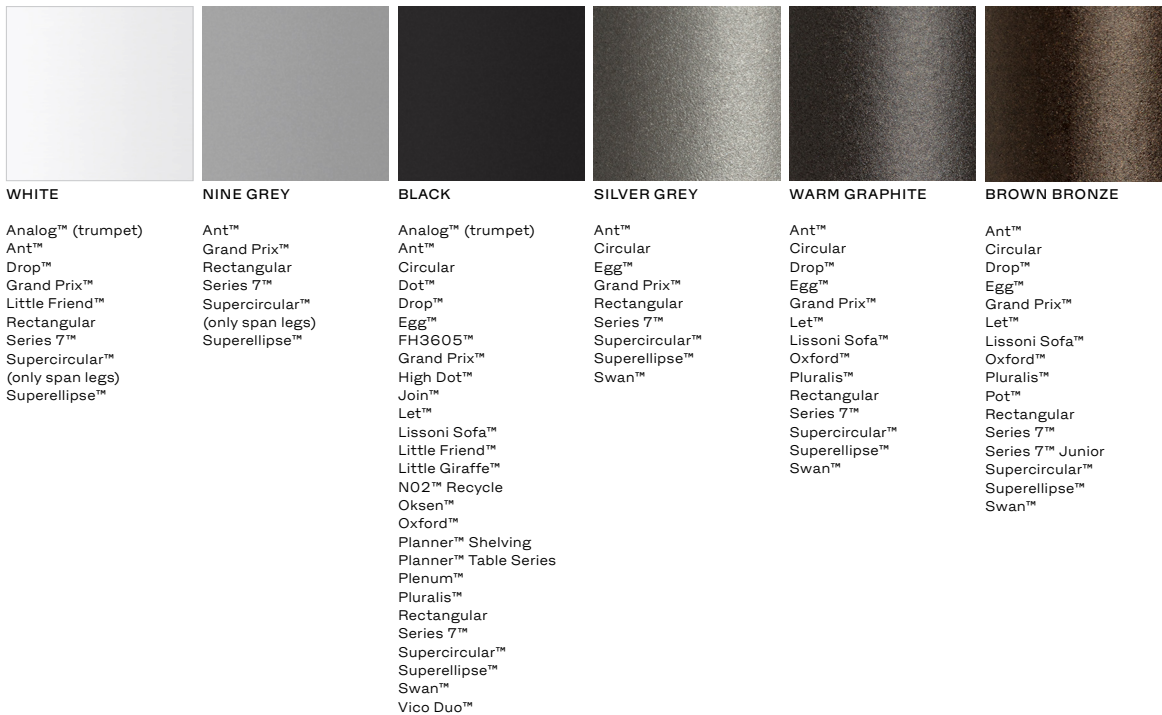
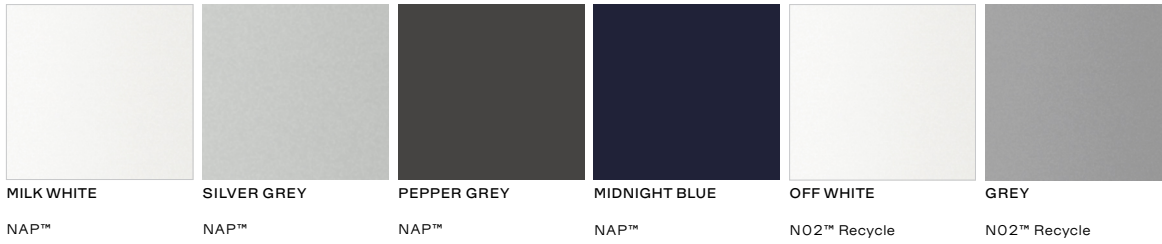

# SURFACE SELECTION

Colours and materials may vary from the images shown.  
Actual colour, gloss level and structure may vary.

## STEEL

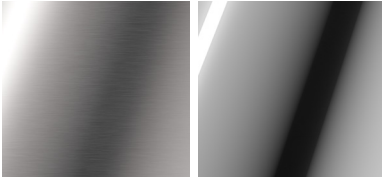

BRUSHED STAINLESS  
STEEL - MATT

Lissoni Sofa™

CHROMED STEEL  
- BRIGHT

Ant™  
Children's Chairs  
Circular  
Coat Tree™  
Dot™  
Drop™  
Egg™ Table  
FH3605™  
Grand Prix™  
High Dot™  
Let™  
Lily™  
Little Giraffe™  
NO2™ Recycle  
NAP™  
Pot™  
Rectangular  
Series 3300™  
Series 7™  
Series 7™ Junior  
Supercircular™  
(only span legs)  
Superellipse™  
Vico Duo™

## ALUMINIUM

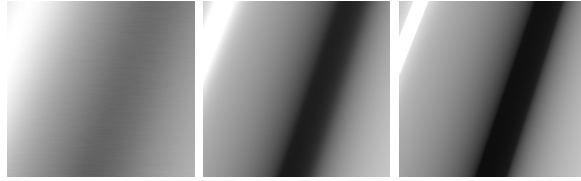

BRUSHED  
- MATT

Circular  
Egg™  
Favn™  
Fri™  
Little Giraffe™  
(swivel base)  
Lune™  
Oksen™  
Oxford™  
Ro™  
Ro™ Sofa  
Swan™  
Swan Sofa™  
Supercircular™  
(only pedestal base)

POLISHED  
- BRIGHT

Little Friend™  
NO2™ Recycle  
(swivel base)  
Pluralis™

CHROMED  
- BRIGHT

Oxford™

## PAPER CORD

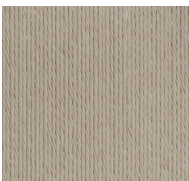

NATURAL

Carimate™