

# 2024 PRICE LIST

**Price list Sweden – SEK**

**arper**

# SENAB

## Färgmarkeringar och/eller symboler för hållbara alternativ i prislistan:

### Mörkgrön markering eller symbol

Miljömärkt produkt – Möbler där hela den sammansatta varan har en typ 1 miljömärkning enligt ISO 14024 med Svanen, Möbelfakta, EU Ecolabel eller annan likvärdig märkning.

### Ljusgrön markering eller symbol

Hållbarhetsmärkt produkt eller beståndsdel – Möbler där hela eller delar av den sammansatta varan är hållbarhetsmärkt, exempelvis med FSC, EU Ecolabel eller OEKO-TEX®. Leverantören ska kunna ge mer detaljerad information om vilka delar eller variationer som är hållbarhetsmärka vid begäran.

### Orange markering eller symbol

Klimatberäknad produkt – Produkt med dokumenterad miljövarudeklaration (EPD) enligt ISO 14025.

### Lila markering eller symbol

Produkt med återvunnet eller förnybart material (enligt definitionerna i ISO 14021). Leverantören ska kunna ge information om andel (%) återvunnet och/eller förnybart (biobaserat) vid begäran. Märkning av återvinningsbart material utgår.

### Blå markering eller symbol

Demonterbar produkt – Produkt som är demonterbar till olika komponenter och beståndsdelar som i första hand möjliggör återbruk och i andra hand materialåtervinning när produkten nått sin fulla livslängd. Produkten ska vara designad för renovering, det vill säga att det ska vara enkelt att reparera och byta ut moduler, komponenter och beståndsdelar som slits över tid. Exempelvis ska ytskikt, som bordsskivor, textil och stoppning kunna tas isär, avlägsnas och ersättas med hjälp av vanligt förekommande manuella verktyg, ej specialverktyg. Enklare reparationer och utbytesarbeten ska kunna utföras av en lekman. Om det krävs fackmanakunskap för mer avancerade arbeten ska det framgå av anvisningarna som leverantören ska kunna ge vid begäran. Anvisningarna ska innehålla en sprängskiss, steg för steg beskrivning inklusive vilka verktyg som krävs samt hur möbelns ingående delar bör källsorteras.





## Portfolio by Space & Function

We are a fast-growing company founded in 1989. We have grown from a furniture manufacturing business, to an international design presence, dramatically increasing our product offer across multiple product typologies.

Our design principles lead us in creating highly versatile products that spontaneously adapt to a multiplicity of contexts, styles and uses that are difficult to fit into a specific pre-established category.

Supporting you to easily navigate the totality of Arper's portfolio, with its multiple configuration options, we created the "Portfolio by Space & Function" tool. It aims at illustrating our product offering segmented by typical space situations, and correlated needs.

The Spaces & Functions we identified and illustrated are:

- — Lounge – Waiting Area
- — Break Out Area
- — Bar & Cafeteria
- — Restaurant
- — Meeting Room
- — Executive Offices
- — Workplace
- — Learning, Training & Conferencing
- — Outdoor
- — Stackable Guest chair

Please note in the tool we segmented our standard product offer. Should you have customization requests, please contact our Sales Dept. The "Portfolio by Space & Function" tool is available at the following links:

[https://arper.com/media/assets/PDF/Space\\_and\\_Function\\_Portfolio\\_Eng.pdf](https://arper.com/media/assets/PDF/Space_and_Function_Portfolio_Eng.pdf)



# Introduction to Arper Price List

Arper Price List is a complete and comprehensive tool, including all relevant information to formulate an order. Please find below some instructions to simplify the consultation.

- 1 Product description and materials with which it is made; information on stacking characteristics (where possible) and related matching accessories (the complete list can be found on the last pages of each specific collection).  
As far as sofas and upholstered items in general are concerned, seat height indicated in the price list refers to the maximum height measured in the seat center.
- 2 Prices matrix: for each article code number, the prices exclusive of VAT are shown, according to the 14 classes of upholstery available.
- 3 Technical information related to:  
shipping: number of packages, weight and volume  
product: fabric length / leather needed for the realization of the product with upholstery outside the price list (COM and COL)  
resistance and fire retardancy testing to which the product has been subjected and validated (only available for upholstery within the Carded In programme).
- 4 Finishes available for base and shell; detailed images of elements that can be configured on the product (e.g. armrests).
- 5 Technical and environmental product certifications available.

## Currency

Prices are indicated in Sweden Krone (SEK).  
All prices are unit prices without VAT (excluding VAT).

in writing to Arper, citing the specifications of the fire-retardant norm with which the articles must comply.

## Dimensions

The dimensions of all articles are given in centimetres (cm).

## Quantity

The number of pieces per box is stated in the description of the selected item – any quantity other than that specified is not permitted.

It is not possible to combine articles of different colours and/or materials and/or structure finishes inside the same box.

## Volume

The stated volume refers to the space occupied by the box(es) necessary for the selected item. It is therefore recommended that an increase of approximately 10-15% should be applied to the total volume to allow for gaps which naturally occur between cartons whilst loading.

The company reserves the right to make modifications and improvements of a technical or aesthetic nature to the product without warning.

## Fire-retardancy

Arper products can be supplied treated for fire-retardancy. However, since the regulations vary from one place to another, we advise you to check up on the local regulations. Any requests for fire-retardant treatment must be sent

## Abbreviations



Disassembled



Fire-retardancy



Outdoor

# Consultation Guidelines

## Catifa 46

Design by Lievore Altherr Molina, 2004

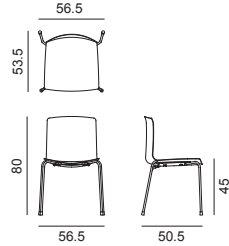

Chair with four-leg frame, available in chromed or powdercoated steel, or brushed stainless steel versions. The shell is available in single-colour polypropylene, bi-colour polypropylene or upholstered in hard leather grade 1 (CT) or hard leather grade 2 (CU). Versions with polypropylene shell and powdercoated or brushed base can be used outdoor. Steel armrests, also with pad, are available upon request.

### Stackability:

- Up to 10 pcs. (should the weight exceed 25 kilos a handling tool must be used).
  - With trolley: up to 20 pcs.
  - CT/CU versions: max. 5 pcs. With stacking pad.
- VERSION WITH ARMRESTS STACKABILITY**
- Up to 5 pcs. (should the weight exceed 25 kilos a handling tool must be used).

### Accessories:

- Link Art. 0258
- Stacking protection pad with link Art. 0260
- Cushion Art. 0261
- Stacking protection pad Art. 0262
- Basket Art. 0265
- Trolley Art. 0760
- Set of glides Art. 2015
- Movable link Art. 2073

ART. 0251	CT	CU	PO bi-color	PO single-color
CHROMED / POWDERCOATED	XX	XX	XX	XX
BRUSHED STAINLESS STEEL	XX	XX	XX	XX
Armrests BV	+ XX			
Armrests BV brushed stainless steel	+ XX			
Armrests CV - pad (only for PO)	+ XX			
Hole on shell to allow water drainage (only for PO)	+ XX			
Polypropylene fire retardant (only for PO)	+ XX			
(For finishes: PO00101/109/112/209/212; for other colors qty min. 300 pcs)				

SHIPMENT DETAILS	TECHNICAL SPECIFICATIONS	RESISTANCE TEST
<b>Art.0251</b> 1 pz = 2  - kg 7,9/ m² 0,25 4 pz = 2  - kg 28/ m² 0,32 	<b>Art.0251</b> Outdoor: only for PO+S03, V12, V13, V39, V48, V53, V54, V55, V56, V57	<ul style="list-style-type: none"> <li>• EN 1728:2000 - EN 15373:2007 6.10</li> <li>• EN 1728:2000 - EN 15373:2007 6.16</li> <li>• EN 1728:2000 - EN 15373:2007 6.2.2</li> <li>• EN 1728:2000 - EN 15373:2007 6.6</li> <li>• EN 1728:2000 - EN 15373:2007 6.8</li> <li>• EN 1728:2012 - EN 16139:2013 6.16</li> <li>• ANSI/BIFMA X5.1-2002/16</li> <li>• EN 1022:05</li> <li>• EN 1728:2012 - EN 16139:2013 6. 5</li> <li>• EN 1728:2012 - EN 16139:2013 6.18</li> <li>• UNI 9083/87</li> </ul> <ul style="list-style-type: none"> <li>• EN 1728:2000 - EN 15373:2007 6.15</li> <li>• EN 1728:2000 - EN 15373:2007 6.2.1</li> <li>• EN 1728:2000 - EN 15373:2007 6.5</li> <li>• EN 1728:2000 - EN 15373:2007 6.7</li> <li>• EN 1728:2012 - EN 16139:2013 6.15</li> <li>• ANSI/BIFMA X5.1-2002/11</li> <li>• ANSI/BIFMA X5.1-2002/6</li> <li>• EN 1728:2012 - EN 16139:2013 6. 4</li> <li>• EN 1728:2012 - EN 16139:2013 6.17</li> <li>• TUV GS (EN16139)</li> </ul>
<b>FIRE RETARDANT TEST</b> BS5852/90 Sez.5 cigarette match polypropylene • Classe 1 polypropylene • EN 1021 - 1/2 polypropylene • M2 polypropylene • California TB133 polypropylene • BS5852 Sch. 5 Part 1 CT CU		

### Frame Base



# General Terms and Conditions of Sale

## Freight charges: details

Order value	Freight charge
up to 17.000 SEK	1300 SEK
above 17.000 SEK	DDP

## Fabric and Leather programs

All fabrics and materials on this Price List are divided into 14 classes, identified by an alphabetical code (A, B, C, D,... ). These classes include the customer's fabrics (COM) and the customer's leathers (COL) belonging to classes B and C respectively.

Both the "Carded-In" and "Graded-In" fabric programs are available for all Arper product collections. Detailed information will be provided on the following pages.

---

### Carded-in

All fabrics and materials on the 2022 Arper price list are part of the Carded-In collection.

Specifically: collections Kvadrat, Camira, Fidivi, Gabriel, Maharam, Rohi, Rubelli, Spradling, Sunbrella and leathers.

### Graded-in

The Graded-In program introduces a selection of fabrics from different suppliers in the Arper offering. In relation to the Graded-In fabrics, Arper guarantees the feasibility of processing for its own products. The fabrics have been divided into 14 classes, identified by an alphabetical code.

---

### Chairs and Stools

Aava 02 Leaf chair  
Adell Mixu  
Aston Norma  
Aston Club Saari chair  
Arcos Saya  
Art. 6100 Stacy  
Art. 6103  
Babar  
Catifa 46 Cushions  
Catifa 53  
Catifa Up Owl  
Catifa Sensit Gego  
Catifa 60 Leaf  
Catifa 70 Lines  
Catifa 80 Pleats  
Cila  
Cila Go  
Duna 02  
Juno 02  
Kata  
Kinesit

### Sofas and Benches

Arcos  
Colina  
Kiik  
Loop  
Pix  
Ralik  
Saari Sofa  
Sean  
Shaal  
Steeve  
Zinta

### Panels and Furnishings

Paravan  
Parentesit

# Leather finishes

The leather upholstery offer consists of the following program:

---



Elmosoft leather

Semi-aniline leather Chrome free

Leather

Soft leather

Pigmented leather



Elmocoast leather

Pigmented leather

Semi-aniline leather combines naturalness, comfort and durability. The surface of this leather is treated with a lightweight coat of color that increases its wear resistance, preserving its natural look with a soft and pleasing feel.

Elmosoft leather: soft and flexible semi-aniline leather. Its softness and breathability, coupled with a durability and an extremely wide color range, make it suitable both for contract and residential sectors.

Pigmented leather in terms of manufacture, the leather undergoes the same processes as aniline or semi-aniline leather, with additional dyeing and finishing treatments to meet different needs in terms of comfort, softness to the touch, strength, durability and color. Its wear resistance and ease of cleaning make it suitable for many uses.

Soft leather: leather characterized by a smooth and uniform surface, soft to the touch with a delicate and natural grain, which lends it a particularly elegant feel.

Neocoast leather: leather characterized by a uniform surface, with a light grain and a soft feel, available in a wide range of shades.

# Leather finishes

## Natural characteristics:

Leather and hard leather may show marks and imperfections such as wrinkles, veins, differences in color from one batch to another. These are distinctive features that distinguish genuine leathers and their natural beauty, ensuring the authenticity of the material and the unique comfort that only a natural product can offer.

Also our leather samples reflect this variability, both among different types of leathers and for the same type of leather, changing the shades of color and their natural features.

Any samples, supplied on request with reference to individual orders, are not to be considered as a guarantee of perfect homogeneity between sample and actual supply.

In this respect, the characteristics listed below are intended to be compliant with Arper quality standards and shall not constitute a ground for disputing products:

### Grain variations example

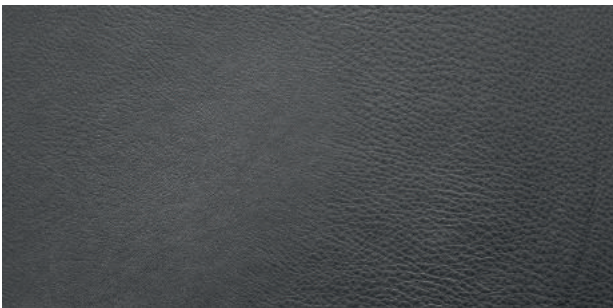

### Backbone example



— Grain variations: areas of the leather where grain can be coarse, for example the part of the leather between the side and the belly.

— Wrinkles, veins and stretch marks: they have a width of about 3-4 mm, with a slightly rougher grain in the surrounding area. They are more visible against the light.

— Backbone: back part of the animal, where the skin is the most valuable as it is the thickest and most compact part. It can have wrinkles.

— Insect bites: small marks on the surface of the leather due to different types of insect bites.

### Wrinkles, veins and stretch marks example

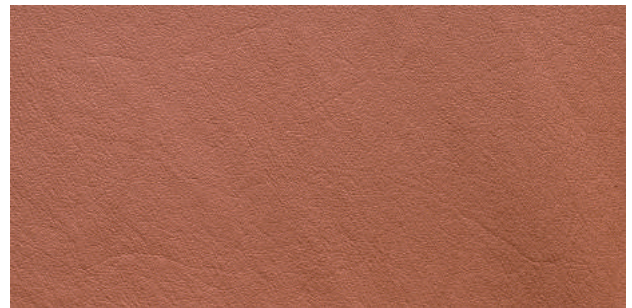

### Insect bites example

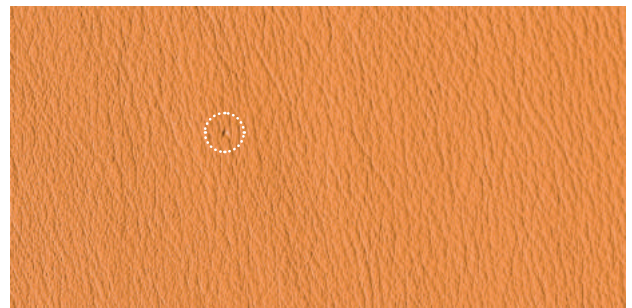

## Cleaning and maintenance:

Avoid exposure of the products to direct sunlight: it can alter the color of upholstery.

Avoid exposure to heat sources.

Dust the leather regularly with a soft dry cloth.

Any stain can be removed using a cloth dampened with water and neutral soap. Do not rub, but gently dab from the edge towards the center of the stain. Dry immediately after treatment.



## Carded-in

The fabrics included in the Carded-In program benefit from specific promotions by Arper, namely the availability of fire-resistance tests carried out on the finished product, as well as additional certifications shown on each product page of the price list. Arper also provides the marketing tools required for the promotion of materials, such as fabric samples, according to sales needs, as well as any information and assistance that may prove necessary.

To verify the division of fabrics into their new classes, see the tables below.  
For any inquiry, please contact Arper Sales Department.

	Collections	Upholstery Code	Chairs Arper Grade	Sofas Arper Grade	Panels Arper Grade
<b>Kvadrat</b>	Atom	AM	Atom		
	Balder 3	B1	I	I	I
	Canvas 2	CV	D	F	D
	Divina 3	DV	G	I	G
	Divina MD	DI	G	I	G
	Divina Melange 3	DM	G	I	G
	Field 2	FI	B	C	B
	Fiord 2	FD	F	F	F
	Floyd	F1	C	C	C
	Hallingdal 65	HA	G	G	G (*)
	Jaali	JA	G	G	G
	Patio – Outdoor	PT	D	D	
	Re-wool	RW	E	E	E
	Remix 3	RX	C	D	C
	Revive 1	R1	B	B	B
	Ria	RA	Ria		
	Sonar 3	S7	Sonar 3		
	Steelcut 3	SE	G	H	G
	Steelcut Trio 3	ST	G	H	G
	Tonus 4	T3	F	G	F
	Vidar 4	VD	J	J	J

## Carded-in

	Collections	Upholstery Code	Chairs Arper Grade	Sofas Arper Grade	Panels Arper Grade
<b>Camira</b>	Main Line Flax	MF	C	C	C
	Phoenix	PH	A	A	A
	Synergy	SN	C	C	C
	Urban	UP	B	B	B
<b>Elmo Leather</b>	Elmosoft	ES	ES	ES	
	Neocoast	P4	H	H	
<b>FiDiVi.</b>	Jet	JE	A	A	A
<b>Maharam</b>	Messenger	MS	D	D	D
<b>Rohi</b>	Sera	S8	Sera		
<b>Rubelli</b>	Fabthirty	FB	Fabthirty		
<b>Spradling</b>	Silververtex – Outdoor	SX	C	B	
	Valencia	VL	B	B	
<b>Sunbrella</b>	Heritage – Outdoor	HE	C	C	
	Savane – Outdoor	SV	C	C	
<b>Arper</b>	Pelle fiore	PF	I	I	
	COL	COL	COL	COL	
	COM	COM	COM	COM	COM

## Graded-in

The fabrics from the Graded-In program and applied on Arper products do not undergo any pre-testing. For this reason, should any fire-resistance or flammability test prove necessary, it will be carried out upon request and at the expense of the client.

Furthermore, Arper does not provide fabric samples for the Graded-In products; for any information about the individual fabrics - including the composition and color versions - the client should refer to the specifications issued by the manufacturer of the upholstery.

The manufacturers that have been selected for the Graded-In program are Kvadrat, Camira, Gabriel. The following pages provide information about each supplier.

	Collections	Upholstery Code	Chairs Arper Grade	Sofas Arper Grade	Panels Arper Grade
<b>Kvadrat</b>	Clara 2	CL	D	E	D
	Savanna	SA	G	G	G
	Tonica 2	TN	I	I	I
<b>Camira</b>	Blazer	BL	E	D	E
	Era	ER	A	A	A
	Xtreme	XP	B	B	B
<b>Gabriel</b>	Atlantic	AT	B	B	B
	Crisp	CR	D	D	D
	Fame	FA	C	C	C
	Fighter	FH	A	A	A
	Medley	MY	B	B	B
	Step	S1	B	B	B
	Step Melange	SM	B	B	B

The fabrics from the collections listed in the table above are available on all of Arper product collections, therefore the client is not required to send any samples for approval. For all the other fabrics not included in this selection, the standard procedure for COM fabrics will apply. Upon the needs of a specific project, and at the sole discretion of the Company, Arper is available to quote the service to purchase fabrics not included in its Price List, from the following suppliers: Kvadrat, Camira, Gabriel.

For further information, please visit the websites:

Kvadrat — <https://kvadrat.dk>  
 Camira — <https://www.camirafabrics.com>  
 Gabriel — <https://www.gabriel.dk>

## Summary chart for Carded-In and Graded-In Program

Supplier	Collection	Upholstery Code	Chairs Arper Grade	Sofas Arper Grade	Panels Arper Grade	Program
Kvadrat	Atom	AM	Atom			Carded In
Kvadrat	Balder 3	B1	I	I	I	Carded In
Kvadrat	Canvas 2	CV	D	F	D	Carded In
Kvadrat	Clara 2	CL	D	E	D	Graded In
Kvadrat	Divina 3	DV	G	I	G	Carded In
Kvadrat	Divina MD	DI	G	I	G	Carded In
Kvadrat	Divina Melange 3	DM	G	I	G	Carded In
Kvadrat	Field 2	FI	B	C	B	Carded In
Kvadrat	Fiord 2	FD	F	F	F	Carded In
Kvadrat	Floyd	F1	C	C	C	Carded In
Kvadrat	Hallingdal 65	HA	G	G	G (*)	Carded In
Kvadrat	Jaali	JA	G	G	G	Carded In
Kvadrat	Patio – Outdoor	PT	D	D		Carded In
Kvadrat	Re-wool	RW	E	E	E	Carded In
Kvadrat	Remix 3	RX	C	D	C	Carded In
Kvadrat	Revive 1	R1	B	B	B	Carded In
Kvadrat	Ria	RA	Ria			Carded In
Kvadrat	Savanna	SA	G	G	G	Graded In
Kvadrat	Sonar 3	S7	Sonar 3			Carded In
Kvadrat	Steelcut 3	SE	G	H	G	Carded In
Kvadrat	Steelcut Trio 3	ST	G	H	G	Carded In
Kvadrat	Tonica 2	TN	I	I	I	Graded In
Kvadrat	Tonus 4	T3	F	G	F	Carded In
Kvadrat	Vidar 4	VD	J	J	J	Carded In
Camira	Blazer	BL	E	D	E	Graded In
Camira	Era	ER	A	A	A	Graded In
Camira	Main Line Flax	MF	C	C	C	Carded In
Camira	Phoenix	PH	A	A	A	Carded In
Camira	Synergy	SN	C	C	C	Carded In
Camira	Urban	UP	B	B	B	Carded In
Camira	Xtreme	XP	B	B	B	Graded In
Elmo Leather	Elmosoft	Leather	ES	ES		Carded In
Elmo Leather	Neocoast	Leather	P4	H	H	Carded In
FiDiVi.	Jet		JE	A	A	Carded In
Gabriel	Atlantic		AT	B	B	Graded In
Gabriel	Crisp		CR	D	D	Graded In
Gabriel	Fame		FA	C	C	Graded In
Gabriel	Fighter		FH	A	A	Graded In
Gabriel	Medley		MY	B	B	Graded In
Gabriel	Step		S1	B	B	Graded In
Gabriel	Step Melange		SM	B	B	Graded In
Maharam	Messenger		MS	D	D	Carded In
Rohi	Sera		S8	Sera		Carded In
Rubelli	Fabthirty		FB	Fabthirty		Carded In
Spradling	Silvertex – Outdoor		SX	C	B	Carded In
Spradling	Valencia	Coated Fabric	VL	B	B	Carded In
Sunbrella	Heritage – Outdoor		HE	C	C	Carded In
Sunbrella	Savane – Outdoor		SV	C	C	Carded In
Arper	Pelle fiore	Leather	PF	I	I	Carded In
	COL		COL	COL		
	COM		COM	COM	COM	



# General conditions for COM/COL customised supplies

Before accepting a customised order using materials provided by the customer, Arper SPA requires a sample of fabric/leather to be submitted DDP (Delivered Duty Paid), together with the duly completed materials chart for a preliminary evaluation of feasibility. For plain color fabrics, the sample must have a size of at least 400 mm x 300 mm; if the fabric features a decorative pattern, the customer is required to contact Arper SPA to ask for the exact size of the sample to send.

If the result of the preliminary test on the fabric/leather sample is not conclusive, Arper SPA will ask the customer to supply a sufficient quantity of material to produce a complete sample, which will then be invoiced in the normal way and sent to the customer for evaluation in accordance with a procedure to be agreed.

The information obtained during the experimentation phase might lead to a request for additional quantities of material and/or lengthening of delivery times. The initial estimate prepared by Arper SPA or the COM/COL list price will be increased by 10% if the customer's order is for less than 8 pieces or if the material supplied does not conform with Arper's product characteristics, resulting in inefficient production.

Arper SPA will not accept any despatch of COM/COL material until the order with relative indication of the quantity of covering material has been accepted.

If the covering material is sent by any delivery method other than DDP (Delivered Duty Paid), Arper reserves the right to reject the material or increase its charge to the customer.

The customer's own fabric must always be sent along with the related invoice, in order to complete the administration procedures connected to product realization and, for products intended for the foreign market, to comply with the necessary customs clearance procedures.

Even if COM/COL is accepted, Arper SPA shall in no way be responsible for the appearance, durability, brightness of colours or any other type of quality problem encountered with the material. The responsibility of Arper SPA is limited to any defects directly attributable to the work performed and warranty will not be extended to the technical performance and/or aesthetic results obtained with non standard materials.

Arper SPA does not accept COM with fabric already listed in the Recapitulations table.

The reported measures refer to bielastic fabrics with solid colour.

For different types of fabrics (monoelastic, print, etc.)

requirements and prices will be evaluated upon request.

## Customer materials management form

---

Customer: \_\_\_\_\_

Delivery date: \_\_\_\_\_  
Production job order: \_\_\_\_\_  
Customer reference: \_\_\_\_\_

Name of fabric or leather manufacturer	Name of collection	Colour	Material composition	Fabric width
--	--------------------	--------	----------------------	--------------

---

Special treatments (e.g. anti-stain): \_\_\_\_\_

---

Stretch fabric:      Yes       No

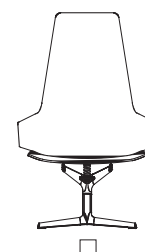
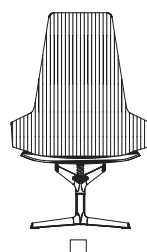
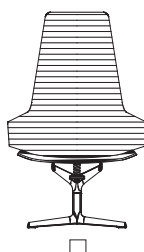
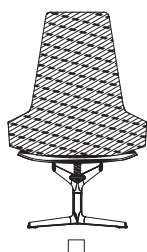

# Catifa 46 / Catifa 53

Design by Lievore Altherr Molina  
2009

*clip-it.easy*<sup>®</sup>

Arper designed and patented a new fixing system for the Catifa 46 and Catifa 53 shells making these two models even more suitable for the contract segment. The new clip-it-easy<sup>®</sup> system is based on a prestressed steel spring fixed directly onto the bases (with or without fixing plate) of the Catifa 46 and Catifa 53 collections without modifying the original Design by of the shell.

This solution offers many advantages such as:

- No shell treatment required;
- Easy to assemble;
- Elimination of any friction between the polypropylene shell and the metal frame (= increased product lifetime)

Thanks to the clip-it-easy<sup>®</sup> system, expressing Arper's attention to continuous product quality improvement, Catifa 46 and Catifa 53 are proving increasingly suitable for spaces involving intensive use of furniture (canteens, offices, contract sector).

For the video and the PDF file on the assembly instructions of Catifa 46 and Catifa 53 please visit our website:

[www.arper.com](http://www.arper.com)



4 legs / sled base



Base with fixed plate

**NO SCREWS  
NO TOOLS**

# Flame Resistance Regulations – Product Requirements

## — Italian market

Approved products in Class 1 or 2 or in Class 1IM (M.D. 26/06/84): see notes on page of the relevant article

## — US market

All Carded-IN coverings available for the US market are compliant with local regulations: TB117-2013 and San Francisco Regulation (AB2998)

## — UK market

All products are available with polyurethane padding compliant with BS5852 Crib 5 (for products that can be configured in both 'STD' and 'IGN' versions, the IGN version must be selected).

All coatings Carded-IN (fabrics, vinyl fabrics, leathers) are compliant with BS5852 Sch. 4 Part.1 Cigarette test “worst case”: the laboratory tests the cover over a filling that is either worse than any that is used or is the worst that can be used by a producer. A positive test result therefore indicates that the covering is compliant when used with padding with superior flame resistance.

## — All markets

Due to difficulties linked to the coexistence of mandatory and voluntary standards on flame resistance and the differences between the various standards and test methods depending on the country, the intended use and the type of material,.... Please contact customer service for a detailed analysis.



# Product Certification



[greenguard.org](http://greenguard.org)



[geca.org.au](http://geca.org.au)



[environdec.com](http://environdec.com)



The mark of  
responsible forestry  
[fsc.org](http://fsc.org)

[environment@arper.com](mailto:environment@arper.com)

CHAIRS  

---

AND STOOLS  

---

# Chairs and Stools

Chairs Arper Grade	Supplier	Collection	Upholstery Code	Program
A	Camira	Era	ER	Graded In
A	Camira	Phoenix	PH	Carded In
A	FiDiVi.	Jet	JE	Carded In
A	Gabriel	Fighter	FH	Graded In
B	Camira	Urban	UP	Carded In
B	Camira	Xtreme	XP	Graded In
B	Gabriel	Atlantic	AT	Graded In
B	Gabriel	Medley	MY	Graded In
B	Gabriel	Step	S1	Graded In
B	Gabriel	Step Melange	SM	Graded In
B	Kvadrat	Field 2	FI	Carded In
B	Kvadrat	Revive 1	R1	Carded In
B	Spradling	Valencia Coated Fabric	VL	Carded In
C	Camira	Main Line Flax	MF	Carded In
C	Camira	Synergy	SN	Carded In
C	Gabriel	Fame	FA	Graded In
C	Kvadrat	Floyd	F1	Carded In
C	Kvadrat	Remix 3	RX	Carded In
C	Spradling	Silvertex – Outdoor	SX	Carded In
C	Sunbrella	Heritage – Outdoor	HE	Carded In
C	Sunbrella	Savane – Outdoor	SV	Carded In
D	Gabriel	Crisp	CR	Graded In
D	Kvadrat	Canvas 2	CV	Carded In
D	Kvadrat	Clara 2	CL	Graded In
D	Kvadrat	Patio – Outdoor	PT	Carded In
D	Maharam	Messenger	MS	Carded In
E	Camira	Blazer	BL	Graded In
E	Kvadrat	Re-wool	RW	Carded In
ES	Elmo Leather	Elmosoft Leather	ES	Carded In
F	Kvadrat	Fiord 2	FD	Carded In
F	Kvadrat	Tonus 4	T3	Carded In
G	Kvadrat	Divina 3	DV	Carded In
G	Kvadrat	Divina MD	DI	Carded In
G	Kvadrat	Divina Melange 3	DM	Carded In
G	Kvadrat	Hallingdal 65	HA	Carded In
G	Kvadrat	Jaali	JA	Carded In
G	Kvadrat	Savanna	SA	Graded In
G	Kvadrat	Steelcut 3	SE	Carded In
G	Kvadrat	Steelcut Trio 3	ST	Carded In
H	Elmo Leather	Neocoast	P4	Carded In
I	Arper	Pelle fiore Leather	PF	Carded In
I	Kvadrat	Balder 3	B1	Carded In
I	Kvadrat	Tonica 2	TN	Graded In
J	Kvadrat	Vidar 4	VD	Carded In

# Chairs and Stools

Chairs	Supplier	Collection	Upholstery Code	Program
Arper Grade				
Atom	Kvadrat	Atom	AM	Carded In
Fabthirty	Rubelli	Fabthirty	FB	Carded In
Ria	Kvadrat	Ria	RA	Carded In
Sera	Rohi	Sera	S8	Carded In
Sonar 3	Kvadrat	Sonar 3	S7	Carded In
COL		COL	COL	
COM		COM	COM	



# AAVA 02

---

Design by Antti Kotilainen

2013 — New Edition 2023



Collection overview

---

Bases



4 legs



4 wooden legs



Sled



Aluminum trestle  
swivel base  
Armrest versions



Aluminum trestle  
fixed base  
Armrest versions



Counter stool  
sled



Bar stool  
sled



Counter stool  
4 wooden legs



Bar stool  
4 wooden legs

---

# Aava 02

---

## Shells

### Polypropylene



Monocolour



With frontal upholstered

The shell in post-consumer polypropylene, mixed with virgin material, may have slight surface variations, due to the intrinsic characteristics of the material used.

### Upholstery



---

Upholstered with separable and replaceable cover

### Wood



With frontal upholstered

### Removable versions



Removable seat cushion



Removable cover



# Aava 02

Design by Antti Kotilainen, 2023

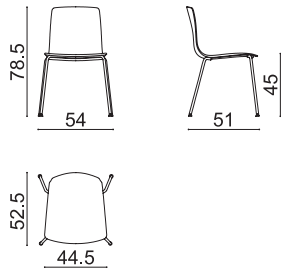

Chair on a 4-leg base in chromed or powder-coated steel. Shell in polypropylene made with post-consumer recycled materials, mixed with virgin material, available in 5 colours. Glides are also available, with felt insert for wood floors.

Accessories:  
 Single trolley Art. 0500  
 Set of glides Art. 3948  
 Link Art. 3970  
 Seat cushion Art. 7641  
 Removable cover Art. 7643

Stackability:  
 (should the weight exceed 25 kilos a handling tool must be used).  
 – without tools up to 10 units  
 – with trolley up to 20 units

<b>SEK ART. 7600</b>	<b>PG</b>	
CHROMED / POWDERCOATED	1917	
Hole on shell to allow water drainage	+ 143	
Outdoor powdercoated	+ 512	
<b>SHIPMENT DETAILS</b>	<b>TECHNICAL SPECIFICATIONS</b>	<b>RESISTANCE TEST</b>
<b>Art.7600</b> 1 pz = 2  - kg 6,6/ m³ 0,239 4 pz = 2  - kg 20,4/ m³ 0,292 		
<b>FIRE RETARDANT TEST</b>		

## Frame Base



## Shell

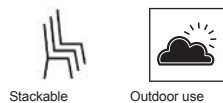

# Aava 02

Design by Antti Kotilainen, 2023

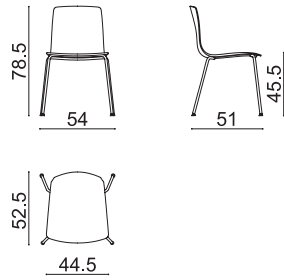

Chair on a 4-leg base in chromed or powder-coated steel. Shell in polypropylene made with post-consumer recycled materials, mixed with virgin material, with upholstery in fabric, leather, coated fabric or customer's own material. The upholstery can be separated and replaced by technical personnel, since it has been applied without the use of glue. Glides are also available, with felt insert for wood floors.

Accessories:  
 Single trolley Art. 0500  
 Set of glides Art. 3948  
 Stacking protection pad Art. 3950  
 Link Art. 3970

Stackability:  
 (should the weight exceed 25 kilos a handling tool must be used).  
 – with stacking pad, without tools up to 6 units  
 – with stacking pad, with trolley up to 6 units  
 – with link: with stacking pad, without tools up to 6 units  
 – with link: with stacking pad, with trolley up to 6 units

SEK ART. 7618	A	B	C	D	E	F	G	H	I	J	K	L	M	ES
CHROMED / POWDERCOATED	4739	5049	5359	5669	5979	6289	6599	6909	7219	7529	7839	8149	8459	9810
<b>SHIPMENT DETAILS</b>	<b>TECHNICAL SPECIFICATIONS</b>				<b>RESISTANCE TEST</b>									
<b>Art.7618</b> 1 pz = 2  - kg 8,71/ m³ 0,276 4 pz = 2  - kg 24,28/ m³ 0,351 KD	<b>Art.7618</b> COL requirement m² 2.34 H 140 cm. COM Meterage m 0.935													
<b>FIRE RETARDANT TEST</b>														

Frame Base



# Aava 02

Design by Antti Kotilainen, 2023

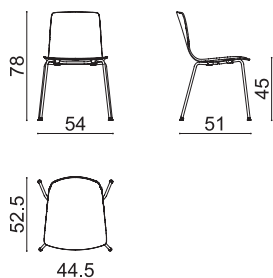

Chair on a 4-leg base in chromed or powder-coated steel. Shell in plywood with a reconstituted oak or walnut finish. Glides are also available, with felt insert for wood floors.

Accessories:  
 Single trolley Art. 0500  
 Link Art. 3941  
 Set of glides Art. 3948  
 Seat cushion Art. 7641

Stackability:  
 (should the weight exceed 25 kilos a handling tool must be used).  
 – without tools up to 10 units  
 – with trolley up to 20 units  
 – with link: without tools up to 12 units  
 – with link: with trolley up to 20 units

<b>SEK ART. 7623</b>	<b>WOOD</b>	
CHROMED / POWDERCOATED	3703	
<b>SHIPMENT DETAILS</b>	<b>TECHNICAL SPECIFICATIONS</b>	<b>RESISTANCE TEST</b>
Art.7623 1 pz = 2  - kg 9,94/ m³ 0,27 4 pz = 2  - kg 25,06/ m³ 0,338 KD		
<b>FIRE RETARDANT TEST</b>		

**Frame Base**



**Shell**

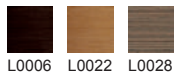

# Aava 02

Design by Antti Kotilainen, 2023

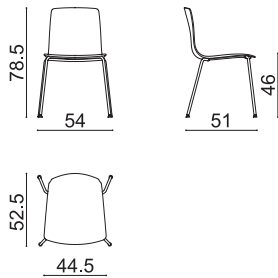

Chair on a 4-leg base in chromed or powder-coated steel. Shell in polypropylene made with post-consumer recycled materials, mixed with virgin material, available in 5 colours and with front upholstery in fabric, leather, coated fabric or customer's own material. Glides are also available, with felt insert for wood floors.

**Accessories:**

- Single trolley Art. 0500
- Set of glides Art. 3948
- Stacking protection pad Art. 3950
- Link Art. 3970

**Stackability:**

(should the weight exceed 25 kilos a handling tool must be used).

- with stacking pad, without tools up to 6 units
- with stacking pad, with trolley up to 6 units
- with link: with stacking pad, without tools up to 6 units
- with link: with stacking pad, with trolley up to 6 units

SEK ART. 7609	A	B	C	D	E	F	G	H	I	J	K	L	M	ES
CHROMED / POWDERCOATED	4631	4785	4939	5093	5247	5401	5555	5709	5863	6017	6171	6325	6479	7144
<b>SHIPMENT DETAILS</b>	<b>TECHNICAL SPECIFICATIONS</b>				<b>RESISTANCE TEST</b>									
<b>Art.7609</b> 1 pz = 2  - kg 8,71/ m³ 0,276 4 pz = 2  - kg 24,28/ m³ 0,351 	<b>Art.7609</b> COL requirement m² 1,08 H 140 cm. COM Meterage m 0.66													
<b>FIRE RETARDANT TEST</b>														

**Frame Base**



**Shell**



# Aava 02

Design by Antti Kotilainen, 2023

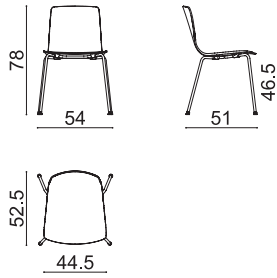

Chair on a 4-leg base in chromed or powder-coated steel. Shell in plywood with a reconstituted oak or walnut finish, with front upholstery in fabric, leather, coated fabric or customer's own material. Glides are also available, with felt insert for wood floors.

Accessories:  
 Single trolley Art. 0500  
 Link Art. 3941  
 Stacking protection pad Art. 3942  
 Set of glides Art. 3948

- Stackability:  
 (should the weight exceed 25 kilos a handling tool must be used).
- with stacking pad, without tools up to 6 units
  - with stacking pad, with trolley up to 6 units
  - with link: with stacking pad, without tools up to 6 units
  - with link: with stacking pad, with trolley up to 6 units

SEK ART. 7632	A	B	C	D	E	F	G	H	I	J	K	L	M	ES
	6429	6583	6737	6891	7045	7199	7353	7507	7661	7815	7969	8123	8277	8954
SHIPMENT DETAILS	TECHNICAL SPECIFICATIONS				RESISTANCE TEST									
<b>Art.7632</b> 1 pz = 2  - kg 9,94/ m³ 0,29 4 pz = 2  - kg 25,06/ m³ 0,357 (KD)	<b>Art.7632</b> COL requirement m² 1.08 H 140 cm. COM Meterage m 0.66													
FIRE RETARDANT TEST														

## Frame Base



## Shell

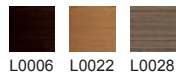

# Aava 02

Design by Antti Kotilainen, 2023

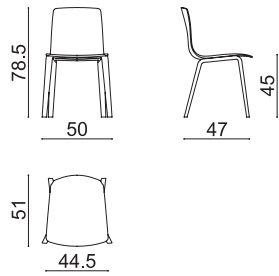

Chair on a 4-leg base in plywood with a reconstituted oak or walnut finish. Shell in polypropylene made with post-consumer recycled materials, mixed with virgin material, available in 5 colours. Glides are also available, with felt insert for wood floors.

Accessories:  
Seat cushion Art. 7641

<b>SEK ART. 7602</b>	PG	
WOOD LEGS	3870	
<b>SHIPMENT DETAILS</b>	<b>TECHNICAL SPECIFICATIONS</b>	<b>RESISTANCE TEST</b>
<b>Art.7602</b> 1 pz = 2  - kg 7,81/ m³ 0,112 4 pz = 2  - kg 21,1/ m³ 0,177 		<ul style="list-style-type: none"> <li>EN 16139:2013 Annex C</li> </ul>
<b>FIRE RETARDANT TEST</b>		

Frame Base

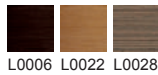

L0006 L0022 L0028



Shell



PG00011 PG00012 PG00013 PG00014 PG00015



# Aava 02

Design by Antti Kotilainen, 2023

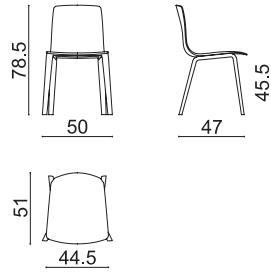

Chair on a 4-leg base in plywood with a reconstituted oak or walnut finish. Shell in polypropylene made with post-consumer recycled materials, mixed with virgin material, with upholstery in fabric, leather, coated fabric or customer's own material. The upholstery can be separated and replaced by technical personnel, since it has been applied without the use of glue. Glides are also available, with felt insert for wood floors.

SEK ART. 7620	A	B	C	D	E	F	G	H	I	J	K	L	M	ES
WOOD LEGS	6692	7002	7312	7622	7932	8242	8552	8862	9172	9482	9792	10102	10412	11763
<b>SHIPMENT DETAILS</b>	<b>TECHNICAL SPECIFICATIONS</b>				<b>RESISTANCE TEST</b>									
<b>Art.7620</b> 1 pz = 2  - kg 9,92/ m³ 0,149 4 pz = 2  - kg 24,98/ m³ 0,235 KD	<b>Art.7620</b> COL requirement m² 2.34 H 140 cm. COM Meterage m 0.935													
<b>FIRE RETARDANT TEST</b>														

Frame Base

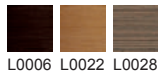

# Aava 02

Design by Antti Kotilainen, 2023

Chair on a 4-leg base and shell in plywood with a reconstituted oak or walnut finish. Base and shell can be configured in the same finish, or by combining various wood finishes. Glides are also provided, with felt insert for wood floors.

Accessories:  
Seat cushion Art. 7641

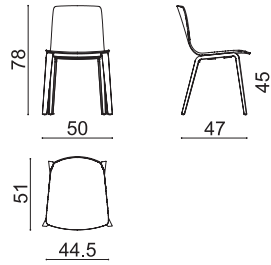

<b>SEK ART. 7625</b>	WOOD	
WOOD LEGS	5656	
<b>SHIPMENT DETAILS</b>	<b>TECHNICAL SPECIFICATIONS</b>	<b>RESISTANCE TEST</b>
<b>Art.7625</b> 1 pz = 2  - kg 9,92/ m³ 0,27 4 pz = 2  - kg 24,98/ m³ 0,338 		
<b>FIRE RETARDANT TEST</b>		

Frame Base

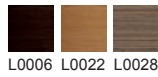

L0006 L0022 L0028

Shell



L0006 L0022 L0028





# Aava 02

Design by Antti Kotilainen, 2023

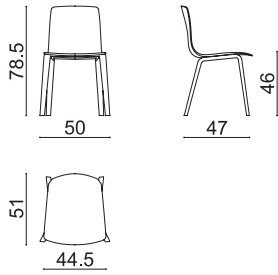

Chair on a 4-leg base in plywood with a reconstituted oak or walnut finish. Shell in polypropylene made with post-consumer recycled materials, mixed with virgin material, available in 5 colours and with front upholstery in fabric, leather, coated fabric or customer's own material. Glides are also available, with felt insert for wood floors.

SEK ART. 7611	A	B	C	D	E	F	G	H	I	J	K	L	M	ES
WOOD LEGS	6584	6738	6892	7046	7200	7354	7508	7662	7816	7970	8124	8278	8432	9097
<b>SHIPMENT DETAILS</b>	<b>TECHNICAL SPECIFICATIONS</b>				<b>RESISTANCE TEST</b>									
<b>Art.7611</b> 1 pz = 2  - kg 9,92/ m³ 0,149 4 pz = 2  - kg 24,98/ m³ 0,235 KD	<b>Art.7611</b> COL requirement m² 1.08 H 140 cm. COM Meterage m 0.66													
<b>FIRE RETARDANT TEST</b>														

Frame Base

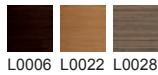

L0006 L0022 L0028



Shell



PG00011 PG00012 PG00013 PG00014 PG00015



# Aava 02

Design by Antti Kotilainen, 2023

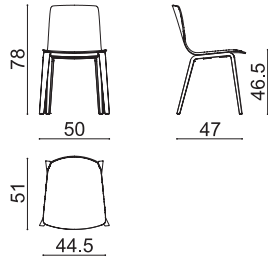

Chair on a 4-leg base and shell in plywood with a reconstituted oak or walnut finish. Base and shell can be configured in the same finish, or by combining various wood finishes. The shell is upholstered in the front with fabric, leather, coated fabric or customer's own material. Glides are also provided, with felt insert for wood floors.

SEK ART. 7634	A	B	C	D	E	F	G	H	I	J	K	L	M	ES
WOOD LEGS	8382	8536	8690	8844	8998	9152	9306	9460	9614	9768	9922	10076	10230	10907
<b>SHIPMENT DETAILS</b>	<b>TECHNICAL SPECIFICATIONS</b>				<b>RESISTANCE TEST</b>									
<b>Art.7634</b> 1 pz = 2  - kg 9,92/ m³ 0,29 4 pz = 2  - kg 24,98/ m³ 0,357 KD	<b>Art.7634</b> COL requirement m² 1.08 H 140 cm. COM Meterage m 0.66													
<b>FIRE RETARDANT TEST</b>														

Frame Base

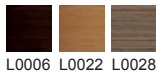

L0006 L0022 L0028



Shell



L0006 L0022 L0028



# Aava 02

Design by Antti Kotilainen, 2023

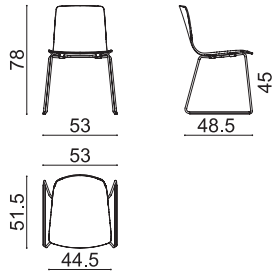

Chair on a sled base in chromed or powder-coated steel. Shell in polypropylene made with post-consumer recycled materials, mixed with virgin material, available in 5 colours. Glides are also available, with felt insert for wood floors.

Accessories:  
 Single trolley Art. 0500  
 Link Art. 3970  
 Seat cushion Art. 7641  
 Removable cover Art. 7643

Stackability:  
 (should the weight exceed 25 kilos a handling tool must be used).  
 – without tools up to 10 units  
 – with trolley up to 20 units  
 – with link: without tools up to 10 units

<b>SEK ART. 7601</b>	<b>PG</b>	
CHROMED / POWDERCOATED	2168	
Hole on shell to allow water drainage	+ 143	
Outdoor powdercoated	+ 512	
<b>SHIPMENT DETAILS</b>	<b>TECHNICAL SPECIFICATIONS</b>	<b>RESISTANCE TEST</b>
<b>Art.7601</b> 1 pz = 2  - kg 7,95/ m³ 0,228 4 pz = 2  - kg 25,8/ m³ 0,305 		
<b>FIRE RETARDANT TEST</b>		

## Frame Base



## Shell



# Aava 02

Design by Antti Kotilainen, 2023

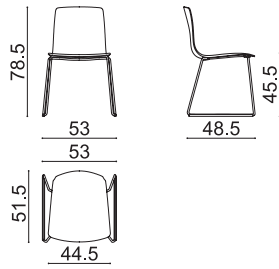

Chair on a sled base in chromed or powder-coated steel. Shell in polypropylene made with post-consumer recycled materials, mixed with virgin material, with upholstery in fabric, leather, coated fabric or customer's own material. The upholstery can be separated and replaced by technical personnel, since it has been applied without the use of glue. Glides are also available, with felt insert for wood floors.

Accessories:  
 Single trolley Art. 0500  
 Stacking protection pad Art. 3950  
 Link Art. 3970

Stackability:  
 (should the weight exceed 25 kilos a handling tool must be used).  
 – with stacking pad, without tools up to 6 units  
 – with stacking pad, with trolley up to 6 units  
 – with link: with stacking pad, without tools up to 6 units  
 – with link: with stacking pad, with trolley up to 6 units

SEK ART. 7619	A	B	C	D	E	F	G	H	I	J	K	L	M	ES
CHROMED / POWDERCOATED	4990	5300	5610	5920	6230	6540	6850	7160	7470	7780	8090	8400	8710	10061
<b>SHIPMENT DETAILS</b>	<b>TECHNICAL SPECIFICATIONS</b>				<b>RESISTANCE TEST</b>									
<b>Art.7619</b> 1 pz = 2  - kg 10,06/ m² 0,265 4 pz = 2  - kg 29,68/ m² 0,363 KD	<b>Art.7619</b> COL requirement m² 2.34 H 140 cm. COM Meterage m 0.935													
<b>FIRE RETARDANT TEST</b>														

Frame Base



# Aava 02

Design by Antti Kotilainen, 2023

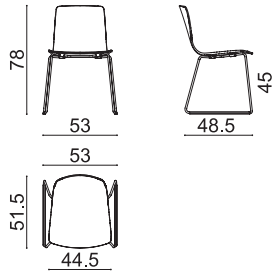

Chair on a sled base in chromed or powder-coated steel. Shell in plywood with a reconstituted oak or walnut finish. Glides are also available, with felt insert for wood floors.

Accessories:  
 Single trolley Art. 0500  
 Link Art. 3941  
 Seat cushion Art. 7641

Stackability:  
 (should the weight exceed 25 kilos a handling tool must be used).  
 – without tools up to 10 units  
 – with trolley up to 20 units  
 – with link: without tools up to 12 units  
 – with link: with trolley up to 20 units

<b>SEK ART. 7624</b>	<b>WOOD</b>	
CHROMED / POWDERCOATED	3954	
<b>SHIPMENT DETAILS</b>	<b>TECHNICAL SPECIFICATIONS</b>	<b>RESISTANCE TEST</b>
<b>Art.7624</b> 1 pz = 2  - kg 11,46/ m² 0,27 4 pz = 2  - kg 31,14/ m² 0,338 KD		
<b>FIRE RETARDANT TEST</b>		

**Frame Base**



**Shell**

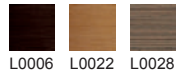

# Aava 02

Design by Antti Kotilainen, 2023

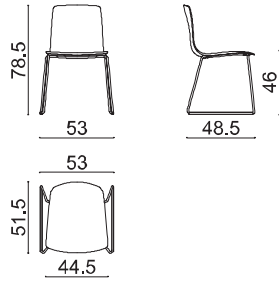

Chair on a sled base in chromed or powder-coated steel. Shell in polypropylene made with post-consumer recycled materials, mixed with virgin material, available in 5 colours and with front upholstery in fabric, leather, coated fabric or customer's own material. Glides are also available, with felt insert for wood floors.

Accessories:  
 Single trolley Art. 0500  
 Stacking protection pad Art. 3950  
 Link Art. 3970

Stackability:  
 (should the weight exceed 25 kilos a handling tool must be used).  
 – with stacking pad, without tools up to 6 units  
 – with stacking pad, with trolley up to 6 units  
 – with link: with stacking pad, without tools up to 6 units  
 – with link: with stacking pad, with trolley up to 6 units

SEK ART. 7610	A	B	C	D	E	F	G	H	I	J	K	L	M	ES
CHROMED / POWDERCOATED	4882	5036	5190	5344	5498	5652	5806	5960	6114	6268	6422	6576	6730	7395
<b>SHIPMENT DETAILS</b>	<b>TECHNICAL SPECIFICATIONS</b>				<b>RESISTANCE TEST</b>									
<b>Art.7610</b> 1 pz = 2  - kg 10,06/ m² 0,265 4 pz = 2  - kg 29,68/ m² 0,363 	<b>Art.7610</b> COL requirement m² 1.08 H 140 cm. COM Meterage m 0.66													
<b>FIRE RETARDANT TEST</b>														

## Frame Base

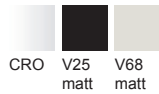

## Shell



# Aava 02

Design by Antti Kotilainen, 2023

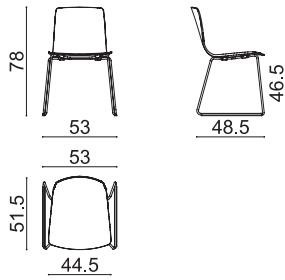

Chair on a sled base in chromed or powder-coated steel. Shell in plywood with a reconstituted oak or walnut finish, with front upholstery in fabric, leather, coated fabric or customer's own material. Glides are also available, with felt insert for wood floors.

Accessories:  
 Single trolley Art. 0500  
 Link Art. 3941  
 Stacking protection pad Art. 3942

- Stackability:  
 (should the weight exceed 25 kilos a handling tool must be used).
- with stacking pad, without tools up to 6 units
  - with stacking pad, with trolley up to 6 units
  - with link: with stacking pad, without tools up to 6 units
  - with link: with stacking pad, with trolley up to 6 units

SEK ART. 7633	A	B	C	D	E	F	G	H	I	J	K	L	M	ES
CHROMED / POWDERCOATED	6680	6834	6988	7142	7296	7450	7604	7758	7912	8066	8220	8374	8528	9205
<b>SHIPMENT DETAILS</b>	<b>TECHNICAL SPECIFICATIONS</b>				<b>RESISTANCE TEST</b>									
<b>Art.7633</b> 1 pz = 2  - kg 11,46/ m³ 0,29 4 pz = 2  - kg 31,14/ m³ 0,357 (KD)	<b>Art.7633</b> COL requirement m² 1.08 H 140 cm. COM Meterage m 0.66													
<b>FIRE RETARDANT TEST</b>														

Frame Base



Shell

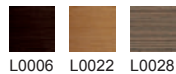

# Aava 02

Design by Antti Kotilainen, 2023

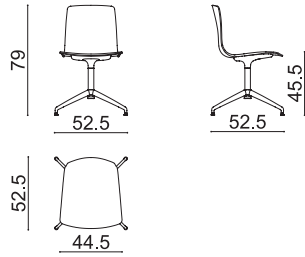

Chair on a swivel trestle base in powder-coated aluminium. Shell in polypropylene made with post-consumer recycled materials, mixed with virgin material, available in 5 colours. Optional armrests in the same colour as the base are also available, equipped with pads in polypropylene in the same finish of the shell. Glides are also available, with felt insert for wood floors.

Accessories:  
 Seat cushion Art. 7641  
 Removable cover Art. 7643

<b>SEK ART. 7603</b>	PG	
	3704	
Armrests - polypropylene pad	+ 1405	
<b>SHIPMENT DETAILS</b>	<b>TECHNICAL SPECIFICATIONS</b>	<b>RESISTANCE TEST</b>
<b>Art.7603</b> 1 pz = 2  - kg 9,25/ m³ 0,157 1 pz = 3  - kg 12,55/ m³ 0,194 4 pz = 5  - kg 34/ m³ 0,397 4 pz = 6  - kg 46,5/ m³ 0,434 		
<b>FIRE RETARDANT TEST</b>		

Frame Base



Shell



Armrest



Armrests - polypropylene pad





# Aava 02

Design by Antti Kotilainen, 2023

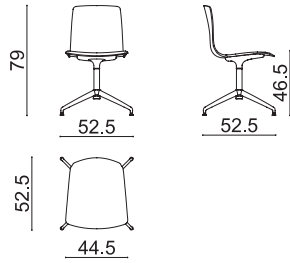

Chair on a swivel trestle base in powder-coated aluminium. Shell in polypropylene made with post-consumer recycled materials, mixed with virgin material, with upholstery in fabric, leather, coated fabric or customer's own material. The upholstery can be separated and replaced by technical personnel, since it has been applied without the use of glue. Optional armrests in the same colour as the base are also available, equipped with pads in polypropylene or in the upholstered version. Glides are also available, with felt insert for wood floors.

SEK ART. 7621	A	B	C	D	E	F	G	H	I	J	K	L	M	ES
POWDERCOATED	6526	6836	7146	7456	7766	8076	8386	8696	9006	9316	9626	9936	10246	11597
Armrests - polypropylene pad	+ 1405													
Armrests CI - only pad	+ 429													
SHIPMENT DETAILS	TECHNICAL SPECIFICATIONS				RESISTANCE TEST									
<b>Art.7621</b> 1 pz = 2  - kg 11,36/ m³ 0,194 1 pz = 3  - kg 14,66/ m³ 0,231 4 pz = 5  - kg 37,88/ m³ 0,455 4 pz = 6  - kg 50,38/ m³ 0,492 	<b>Art.7621</b> COL requirement m² 2.34 H 140 cm. COM Meterage m 0.935													
FIRE RETARDANT TEST														

Frame Base

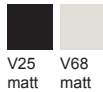

Armrest



# Aava 02

Design by Antti Kotilainen, 2023

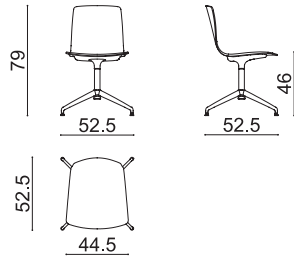

Chair on a swivel trestle base in powder-coated aluminium. Shell in plywood with a reconstituted oak or walnut finish. Optional armrests in the same colour as the base are also available, equipped with pads in wood in the same finish of the shell. Glides are also available, with felt insert for wood floors.

Accessories:  
Seat cushion Art. 7641

<b>SEK ART. 7626</b>	WOOD	
CHROMED / POWDERCOATED	5490	
Armrests - wooden pad	+ 1655	
<b>SHIPMENT DETAILS</b>	<b>TECHNICAL SPECIFICATIONS</b>	<b>RESISTANCE TEST</b>
<b>Art.7626</b> 1 pz = 2  - kg 11,56/ m³ 0,174 1 pz = 3  - kg 14,86/ m³ 0,211 4 pz = 5  - kg 38,68/ m³ 0,393 4 pz = 6  - kg 51,18/ m³ 0,43 		
<b>FIRE RETARDANT TEST</b>		

Frame Base



Shell

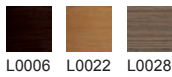

Armrest



Armrests - wooden pad



# Aava 02

Design by Antti Kotilainen, 2023

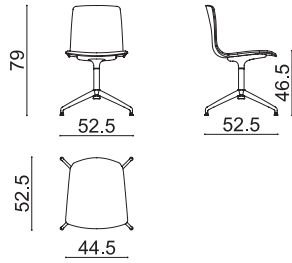

Chair on a swivel trestle base in powder-coated aluminium. Shell in polypropylene made with post-consumer recycled materials, mixed with virgin material, available in 5 colours and with front upholstery in fabric, leather, coated fabric or customer's own material. Optional armrests in the same colour as the base are also available, equipped with pads in polypropylene in the same finish of the shell. Glides are also available, with felt insert for wood floors.

SEK ART. 7612	A	B	C	D	E	F	G	H	I	J	K	L	M	ES
POWDERCOATED	6418	6572	6726	6880	7034	7188	7342	7496	7650	7804	7958	8112	8266	8931
Armrests - polypropylene pad	+ 1405													
SHIPMENT DETAILS	TECHNICAL SPECIFICATIONS				RESISTANCE TEST									
<b>Art.7612</b> 1 pz = 2  - kg 11,36/ m³ 0,194 1 pz = 3  - kg 14,66/ m³ 0,231 4 pz = 5  - kg 37,88/ m³ 0,455 4 pz = 6  - kg 50,38/ m³ 0,492 KD	<b>Art.7612</b> COL requirement m² 1.08 H 140 cm. COM Meterage m 0.66													
FIRE RETARDANT TEST														

Frame Base



Shell



Armrest



# Aava 02

Design by Antti Kotilainen, 2023

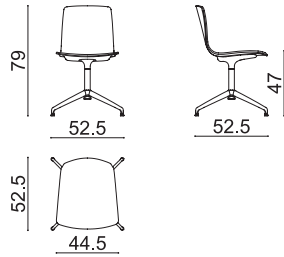

Chair on a swivel trestle base in powder-coated aluminium. Shell in plywood with a reconstituted oak or walnut finish, with front upholstery in fabric, leather, coated fabric or customer's own material. Optional armrests in the same colour as the base are also available, equipped with pads in wood in the same finish of the shell. Glides are also available, with felt insert for wood floors.

SEK ART. 7635	A	B	C	D	E	F	G	H	I	J	K	L	M	
POWDERCOATED	8216	8370	8524	8678	8832	8986	9140	9294	9448	9602	9756	9910	10064	10741
Armrests - wooden pad	+ 1655													
SHIPMENT DETAILS	TECHNICAL SPECIFICATIONS				RESISTANCE TEST									
<b>Art.7635</b> 1 pz = 2  - kg 11,56/ m³ 0,194 1 pz = 3  - kg 14,86/ m³ 0,231 4 pz = 5  - kg 38,68/ m³ 0,413 4 pz = 6  - kg 51,18/ m³ 0,45 	<b>Art.7635</b> COL requirement m² 1.08 H 140 cm. COM Meterage m 0.66													
FIRE RETARDANT TEST														

Frame Base



Shell

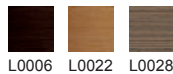

Armrest



Armrests - wooden pad



# Aava 02

Design by Antti Kotilainen, 2023

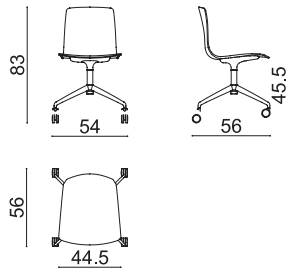

Chair on fixed trestle base in powder-coated aluminium, mounted on self-breaking castors (of the same colour as the base). Shell in polypropylene made with post-consumer recycled materials, mixed with virgin material, available in 5 colours. Optional armrests in the same colour as the base are also available, equipped with pads in polypropylene in the same finish of the shell.

Accessories:  
 Seat cushion Art. 7641  
 Removable cover Art. 7643

<b>SEK ART. 7604</b>	<b>PG</b>	
	4120	
Armrests - polypropylene pad	+ 1405	
<b>SHIPMENT DETAILS</b>	<b>TECHNICAL SPECIFICATIONS</b>	<b>RESISTANCE TEST</b>
<b>Art.7604</b> 1 pz = 2  - kg 9,65/ m³ 0,157 1 pz = 3  - kg 12,95/ m³ 0,194 4 pz = 5  - kg 35,6/ m³ 0,397 4 pz = 6  - kg 48,1/ m³ 0,434 		
<b>FIRE RETARDANT TEST</b>		

Frame Base



Shell



Armrest



# Aava 02

Design by Antti Kotilainen, 2023

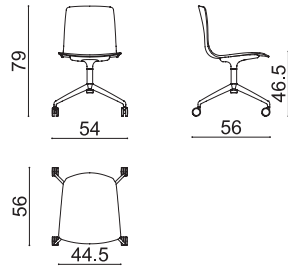

Chair on fixed trestle base in powder-coated aluminium, mounted on self-locking castors (of the same colour as the base). Shell in polypropylene made with post-consumer recycled materials, mixed with virgin material, with upholstery in fabric, leather, coated fabric or customer's own material. The upholstery can be separated and replaced by technical personnel, since it has been applied without the use of glue. Optional armrests in the same colour as the base are also available, equipped with pads in polypropylene or in the upholstered version.

SEK ART. 7622	A	B	C	D	E	F	G	H	I	J	K	L	M	ES
POWDERCOATED	6942	7252	7562	7872	8182	8492	8802	9112	9422	9732	10042	10352	10662	12013
Armrests - polypropylene pad	+ 1405													
Armrests CI - only pad	+ 429													
SHIPMENT DETAILS	TECHNICAL SPECIFICATIONS				RESISTANCE TEST									
<b>Art.7622</b> 1 pz = 2  - kg 11,76/ m³ 0,194 1 pz = 3  - kg 15,06/ m³ 0,231 4 pz = 5  - kg 39,48/ m³ 0,455 4 pz = 6  - kg 51,98/ m³ 0,492 	<b>Art.7622</b> COL requirement m² 2.34 H 140 cm. COM Meterage m 0.935													
FIRE RETARDANT TEST														

Frame Base



Armrest



# Aava 02

Design by Antti Kotilainen, 2023

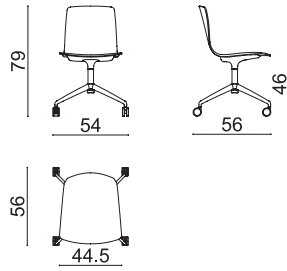

Chair on fixed trestle base in powder-coated aluminium, mounted on self-breaking castors (of the same colour as the base). Shell in plywood with a reconstituted oak or walnut finish. Optional armrests in the same colour as the base are also available, equipped with pads in wood in the same finish of the shell.

Accessories:  
Seat cushion Art. 7641

<b>SEK ART. 7627</b>	WOOD	
CHROMED / POWDERCOATED	5906	
Armrests - wooden pad	+ 1655	
<b>SHIPMENT DETAILS</b>	<b>TECHNICAL SPECIFICATIONS</b>	<b>RESISTANCE TEST</b>
<b>Art.7627</b> 1 pz = 2  - kg 12,16/ m³ 0,174 1 pz = 3  - kg 15,46/ m³ 0,211 4 pz = 5  - kg 41,08/ m³ 0,393 4 pz = 6  - kg 53,58/ m³ 0,43 		
<b>FIRE RETARDANT TEST</b>		

Frame Base



Shell

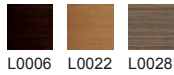

Armrest



Armrests - wooden pad



# Aava 02

Design by Antti Kotilainen, 2023

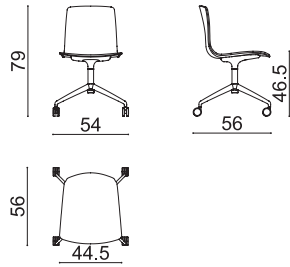

Chair on fixed trestle base in powder-coated aluminium, mounted on self-breaking castors (of the same colour as the base). Shell in polypropylene made with post-consumer recycled materials, mixed with virgin material, available in 5 colours and with front upholstery in fabric, leather, coated fabric or customer's own material. Optional armrests in the same colour as the base are also available, equipped with pads in polypropylene in the same finish of the shell.

SEK ART. 7613	A	B	C	D	E	F	G	H	I	J	K	L	M	ES
POWDERCOATED	6834	6988	7142	7296	7450	7604	7758	7912	8066	8220	8374	8528	8682	9347
Armrests - polypropylene pad	+ 1405													
SHIPMENT DETAILS	TECHNICAL SPECIFICATIONS				RESISTANCE TEST									
<b>Art.7613</b> 1 pz = 2  - kg 11,76/ m³ 0,194 1 pz = 3  - kg 15,06/ m³ 0,231 4 pz = 5  - kg 39,48/ m³ 0,455 4 pz = 6  - kg 51,98/ m³ 0,492 KD	<b>Art.7613</b> COL requirement m² 1.08 H 140 cm. COM Meterage m 0.66													
FIRE RETARDANT TEST														

Frame Base



Shell



Armrest





# Aava 02

Design by Antti Kotilainen, 2023

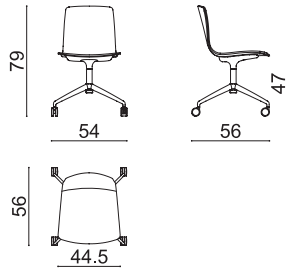

Chair on fixed trestle base in powder-coated aluminium, mounted on self-breaking castors (of the same colour as the base). Shell in plywood with a reconstituted oak or walnut finish, with front upholstery in fabric, leather, coated fabric or customer's own material. Optional armrests in the same colour as the base are also available, equipped with pads in wood in the same finish of the shell.

SEK ART. 7636	A	B	C	D	E	F	G	H	I	J	K	L	M	ES
POWDERCOATED	8632	8786	8940	9094	9248	9402	9556	9710	9864	10018	10172	10326	10480	11157
Armrests - wooden pad	+ 1655													
SHIPMENT DETAILS	TECHNICAL SPECIFICATIONS				RESISTANCE TEST									
<b>Art.7636</b> 1 pz = 2  - kg 12,16/ m³ 0,194 1 pz = 3  - kg 15,46/ m³ 0,231 4 pz = 5  - kg 41,08/ m³ 0,413 4 pz = 6  - kg 53,58/ m³ 0,45 KD	<b>Art.7636</b> COL requirement m² 1.08 H 140 cm. COM Meterage m 0.66													
FIRE RETARDANT TEST														

Frame Base



Shell

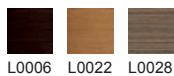

Armrest



# Aava 02 Counter Stool

Design by Antti Kotilainen, 2023

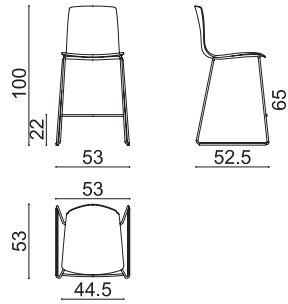

Stool on a sled base in chromed or powder-coated steel. Shell in polypropylene made with post-consumer recycled materials, mixed with virgin material, available in 5 colours. Glides are also available, with felt insert for wood floors. Seat height 65 cm.

Accessories:  
 Single trolley Art. 0500  
 Seat cushion Art. 7641  
 Removable cover Art. 7643

Stackability:  
 (should the weight exceed 25 kilos a handling tool must be used).  
 – without tools up to 10 units

<b>SEK ART. 7605</b>	<b>PG</b>	
	2953	
Hole on shell to allow water drainage	+ 143	
Outdoor powdercoated	+ 619	
<b>SHIPMENT DETAILS</b>	<b>TECHNICAL SPECIFICATIONS</b>	<b>RESISTANCE TEST</b>
<b>Art.7605</b> 1 pz = 2  - kg 11,03/ m³ 0,308 4 pz = 2  - kg 31,58/ m³ 0,396 		
<b>FIRE RETARDANT TEST</b>		

## Frame Base



## Shell



# Aava 02 Bar Stool

Design by Antti Kotilainen, 2023

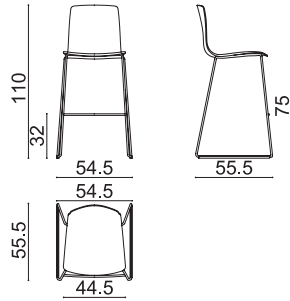

Stool on a sled base in chromed or powder-coated steel. Shell in polypropylene made with post-consumer recycled materials, mixed with virgin material, available in 5 colours. Glides are also available, with felt insert for wood floors. Seat height 75 cm.

Accessories:  
 Single trolley Art. 0500  
 Seat cushion Art. 7641  
 Removable cover Art. 7643

Stackability:  
 (should the weight exceed 25 kilos a handling tool must be used).  
 – without tools up to 10 units

<b>SEK ART. 7606</b>	<b>PG</b>	
	2953	
Hole on shell to allow water drainage	+ 143	
Outdoor powdercoated	+ 619	
<b>SHIPMENT DETAILS</b>	<b>TECHNICAL SPECIFICATIONS</b>	<b>RESISTANCE TEST</b>
<b>Art.7606</b> 1 pz = 2  - kg 11,47/ m³ 0,344 4 pz = 2  - kg 33,34/ m³ 0,499 		
<b>FIRE RETARDANT TEST</b>		

## Frame Base



## Shell



# Aava 02 Counter Stool

Design by Antti Kotilainen, 2023

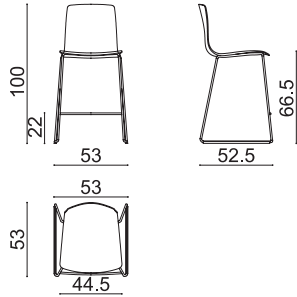

Stool on a sled base in chromed or powder-coated steel. Shell in polypropylene made with post-consumer recycled materials, mixed with virgin material, available in 5 colours and with front upholstery in fabric, leather, coated fabric or customer's own material. Glides are also available, with felt insert for wood floors. Seat height 66,5 cm.

Accessories:  
Single trolley Art. 0500  
Stacking protection pad Art. 3950

Stackability:  
(should the weight exceed 25 kilos a handling tool must be used).  
– with stacking pad, without tools up to 6 units  
– with stacking pad, with trolley up to 6 units

SEK ART. 7614	A	B	C	D	E	F	G	H	I	J	K	L	M	ES
CHROMED / POWDERCOATED	5667	5821	5975	6129	6283	6437	6591	6745	6899	7053	7207	7361	7515	8180
<b>SHIPMENT DETAILS</b>	<b>TECHNICAL SPECIFICATIONS</b>				<b>RESISTANCE TEST</b>									
<b>Art.7614</b> 1 pz = 2  - kg 13,14/ m³ 0,345 4 pz = 2  - kg 35,46/ m³ 0,454 KD	<b>Art.7614</b> COL requirement m² 1.08 H 140 cm. COM Meterage m 0.66													
<b>FIRE RETARDANT TEST</b>														

## Frame Base



## Shell



# Aava 02 Bar Stool

Design by Antti Kotilainen, 2023

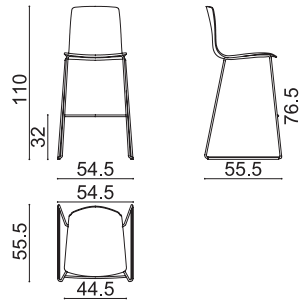

Stool on a sled base in chromed or powder-coated steel. Shell in polypropylene made with post-consumer recycled materials, mixed with virgin material, available in 5 colours and with front upholstery in fabric, leather, coated fabric or customer's own material. Glides are also available, with felt insert for wood floors. Seat height 76,5 cm.

Accessories:  
Single trolley Art. 0500  
Stacking protection pad Art. 3950

Stackability:  
(should the weight exceed 25 kilos a handling tool must be used).  
– with stacking pad, without tools up to 6 units  
– with stacking pad, with trolley up to 6 units

SEK ART. 7615	A	B	C	D	E	F	G	H	I	J	K	L	M	ES
CHROMED / POWDERCOATED	5667	5821	5975	6129	6283	6437	6591	6745	6899	7053	7207	7361	7515	8180
<b>SHIPMENT DETAILS</b>		<b>TECHNICAL SPECIFICATIONS</b>				<b>RESISTANCE TEST</b>								
<b>Art.7615</b> 1 pz = 2  - kg 13,58/ m³ 0,381 4 pz = 2  - kg 37,22/ m³ 0,507 KD		<b>Art.7615</b> COL requirement m² 1.08 H 140 cm. COM Meterage m 0.66												
<b>FIRE RETARDANT TEST</b>														

Frame Base



Shell



# Aava 02 Counter Stool

Design by Antti Kotilainen, 2023

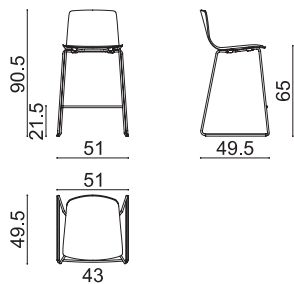

Stool on a sled base in chromed or powder-coated steel. Shell in plywood with a reconstituted oak or walnut finish. Glides are also available, with felt insert for wood floors. Seat height 65 cm.

Accessories:  
Single trolley Art. 0500  
Seat cushion Art. 7642

Stackability:  
(should the weight exceed 25 kilos a handling tool must be used).  
– without tools up to 10 units  
– with trolley up to 20 units

<b>SEK ART. 7628</b>	WOOD	
CHROMED / POWDERCOATED	4477	
<b>SHIPMENT DETAILS</b>	<b>TECHNICAL SPECIFICATIONS</b>	<b>RESISTANCE TEST</b>
<b>Art.7628</b> 1 pz = 2  - kg 13,14/ m³ 0,326 4 pz = 2  - kg 35,46/ m³ 0,351 		
<b>FIRE RETARDANT TEST</b>		

## Frame Base



## Shell

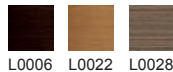

# Aava 02 Bar Stool

Design by Antti Kotilainen, 2023

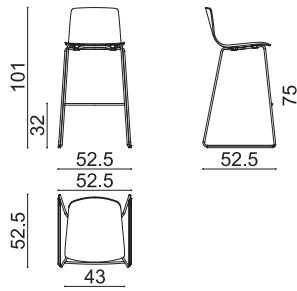

Stool on a sled base in chromed or powder-coated steel. Shell in plywood with a reconstituted oak or walnut finish. Glides are also available, with felt insert for wood floors. Seat height 75 cm.

Accessories:  
 Single trolley Art. 0500  
 Seat cushion Art. 7642

Stackability:  
 (should the weight exceed 25 kilos a handling tool must be used).  
 – without tools up to 10 units  
 – with trolley up to 20 units

<b>SEK ART. 7629</b>	WOOD	
CHROMED / POWDERCOATED	4477	
<b>SHIPMENT DETAILS</b>	<b>TECHNICAL SPECIFICATIONS</b>	<b>RESISTANCE TEST</b>
<b>Art.7629</b> 1 pz = 2  - kg 11,8/ m³ 0,337 4 pz = 2  - kg 34/ m³ 0,364 		
<b>FIRE RETARDANT TEST</b>		

Frame Base



Shell

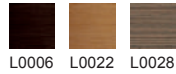

# Aava 02 Counter Stool

Design by Antti Kotilainen, 2023

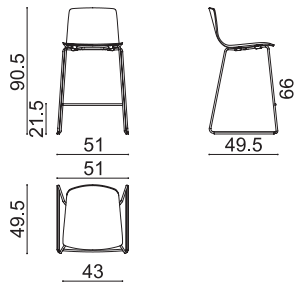

Stool on a sled base in chromed or powder-coated steel. Shell in wood upholstered with fabric, leather, coated fabric or customer's own material. The upholstery can be separated and replaced by technical personnel, since it has been applied without the use of glue. Glides are also available, with felt insert for wood floors. Seat height 66 cm.

Accessories:  
Single trolley Art. 0500  
Stacking protection pad Art. 3942

Stackability:  
(should the weight exceed 25 kilos a handling tool must be used).  
– with stacking pad, without tools up to 6 units  
– with stacking pad, with trolley up to 6 units

SEK ART. 7637	A	B	C	D	E	F	G	H	I	J	K	L	M	ES
CHROMED / POWDERCOATED	5227	5501	5775	6049	6323	6597	6871	7145	7419	7693	7967	8241	8515	9823
<b>SHIPMENT DETAILS</b>	<b>TECHNICAL SPECIFICATIONS</b>				<b>RESISTANCE TEST</b>									
<b>Art.7637</b> 1 pz = 2  - kg 11,36/ m³ 0,345 4 pz = 2  - kg 32,24/ m³ 0,371 KD	<b>Art.7637</b> COL requirement m² 1.86 H 140 cm. COM Meterage m 0.814													
<b>FIRE RETARDANT TEST</b>														

Frame Base





# Aava 02 Bar Stool

Design by Antti Kotilainen, 2023

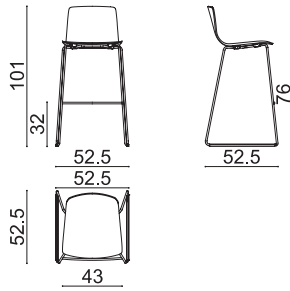

Stool on a sled base in chromed or powder-coated steel. Shell in wood upholstered with fabric, leather, coated fabric or customer's own material. The upholstery can be separated and replaced by technical personnel, since it has been applied without the use of glue. Glides are also available, with felt insert for wood floors. Seat height 76 cm.

Accessories:  
Single trolley Art. 0500  
Stacking protection pad Art. 3942

Stackability:  
(should the weight exceed 25 kilos a handling tool must be used).  
– with stacking pad, without tools up to 6 units  
– with stacking pad, with trolley up to 6 units

SEK ART. 7638	A	B	C	D	E	F	G	H	I	J	K	L	M	ES
CHROMED / POWDERCOATED	5227	5501	5775	6049	6323	6597	6871	7145	7419	7693	7967	8241	8515	9823
<b>SHIPMENT DETAILS</b>		<b>TECHNICAL SPECIFICATIONS</b>				<b>RESISTANCE TEST</b>								
<b>Art.7638</b> 1 pz = 2  - kg 11,8/ m³ 0,381 4 pz = 2  - kg 34/ m³ 0,408 KD		<b>Art.7638</b> COL requirement m² 1.86 H 140 cm. COM Meterage m 0.814												
<b>FIRE RETARDANT TEST</b>														

Frame Base



# Aava 02 Counter Stool

Design by Antti Kotilainen, 2023

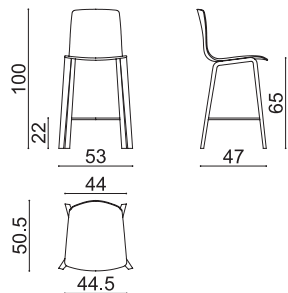

Stool on a 4-leg base in plywood with a reconstituted oak or walnut finish. Shell in polypropylene made with post-consumer recycled materials, mixed with virgin material, available in 5 colours. Glides are also available, with felt insert for wood floors. Seat height 65 cm.

Accessories:  
Seat cushion Art. 7641

<b>SEK ART. 7607</b>	<b>PG</b>	
WOOD LEGS	6597	
<b>SHIPMENT DETAILS</b>	<b>TECHNICAL SPECIFICATIONS</b>	<b>RESISTANCE TEST</b>
<b>Art.7607</b> 1 pz = 2  - kg 8,25/ m³ 0,325 4 pz = 5  - kg 30/ m³ 1,07 		
<b>FIRE RETARDANT TEST</b>		

Frame Base

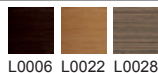

L0006 L0022 L0028



Shell



PG00011 PG00012 PG00013 PG00014 PG00015



# Aava 02 Bar Stool

Design by Antti Kotilainen, 2023

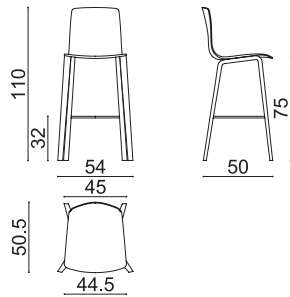

Stool on a 4-leg base in plywood with a reconstituted oak or walnut finish. Shell in polypropylene made with post-consumer recycled materials, mixed with virgin material, available in 5 colours. Glides are also available, with felt insert for wood floors. Seat height 75 cm.

Accessories:  
Seat cushion Art. 7641

<b>SEK ART. 7608</b>	<b>PG</b>	
WOOD LEGS	6597	
<b>SHIPMENT DETAILS</b>	<b>TECHNICAL SPECIFICATIONS</b>	<b>RESISTANCE TEST</b>
<b>Art.7608</b> 1 pz = 2  - kg 8,25/ m³ 0,325 4 pz = 5  - kg 30/ m³ 1,07 		
<b>FIRE RETARDANT TEST</b>		

Frame Base

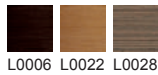

L0006 L0022 L0028



Shell



PG00011 PG00012 PG00013 PG00014 PG00015



# Aava 02 Counter Stool

Design by Antti Kotilainen, 2023

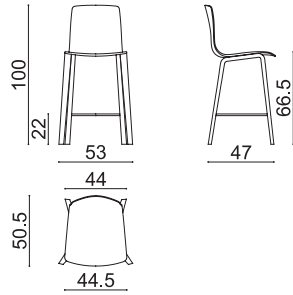

Stool on a 4-leg base in plywood with a reconstituted oak or walnut finish. Shell in polypropylene made with post-consumer recycled materials, mixed with virgin material, available in 5 colours and with front upholstery in fabric, leather, coated fabric or customer's own material. Glides are also available, with felt insert for wood floors. Seat height 66,5 cm.

SEK ART. 7616	A	B	C	D	E	F	G	H	I	J	K	L	M	ES
WOOD LEGS	9311	9465	9619	9773	9927	10081	10235	10389	10543	10697	10851	11005	11159	11824
<b>SHIPMENT DETAILS</b>	<b>TECHNICAL SPECIFICATIONS</b>				<b>RESISTANCE TEST</b>									
<b>Art.7616</b> 1 pz = 2  - kg 10,36/ m³ 0,362 4 pz = 5  - kg 33,88/ m³ 1,128 KD	<b>Art.7616</b> COL requirement m² 1.08 H 140 cm. COM Meterage m 0.66													
<b>FIRE RETARDANT TEST</b>														

Frame Base

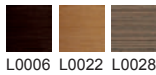

L0006 L0022 L0028



Shell



PG00011 PG00012 PG00013 PG00014 PG00015



# Aava 02 Bar Stool

Design by Antti Kotilainen, 2023

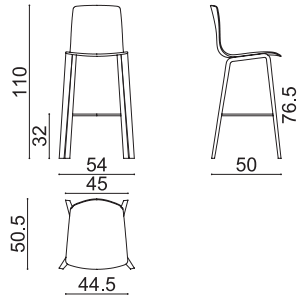

Stool on a 4-leg base in plywood with a reconstituted oak or walnut finish. Shell in polypropylene made with post-consumer recycled materials, mixed with virgin material, available in 5 colours and with front upholstery in fabric, leather, coated fabric or customer's own material. Glides are also available, with felt insert for wood floors. Seat height 76,5 cm.

SEK ART. 7617	A	B	C	D	E	F	G	H	I	J	K	L	M	ES
WOOD LEGS	9311	9465	9619	9773	9927	10081	10235	10389	10543	10697	10851	11005	11159	11824
<b>SHIPMENT DETAILS</b>	<b>TECHNICAL SPECIFICATIONS</b>				<b>RESISTANCE TEST</b>									
<b>Art.7617</b> 1 pz = 2  - kg 10,36/ m³ 0,362 4 pz = 5  - kg 33,88/ m³ 1,128 KD	<b>Art.7617</b> COL requirement m² 1.08 H 140 cm. COM Meterage m 0.66													
<b>FIRE RETARDANT TEST</b>														

Frame Base

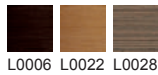

L0006 L0022 L0028



Shell



PG00011 PG00012 PG00013 PG00014 PG00015



# Aava 02 Counter Stool

Design by Antti Kotilainen, 2023

Stool on a 4-leg base and shell in plywood with a reconstituted oak or walnut finish. Base and shell can be configured in the same finish, or by combining various wood finishes. Glides are also available, with felt insert for wood floors. Seat height 66 cm.

Accessories:  
Seat cushion Art. 7642

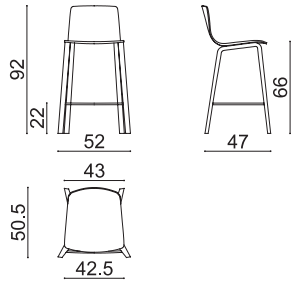

<b>SEK ART. 7630</b>	WOOD	
WOOD LEGS	8121	
<b>SHIPMENT DETAILS</b>	<b>TECHNICAL SPECIFICATIONS</b>	<b>RESISTANCE TEST</b>
<b>Art.7630</b> 1 pz = 2  - kg 8,58/ m³ 0,318 4 pz = 5  - kg 30,66/ m³ 1,042 		
<b>FIRE RETARDANT TEST</b>		

Frame Base

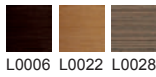

L0006 L0022 L0028

Shell



L0006 L0022 L0028



# Aava 02 Bar Stool

Design by Antti Kotilainen, 2023

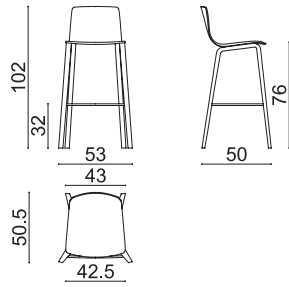

Stool on a 4-leg base and shell in plywood with a reconstituted oak or walnut finish. Base and shell can be configured in the same finish, or by combining various wood finishes. Glides are also available, with felt insert for wood floors. Seat height 76 cm.

Accessories:  
Seat cushion Art. 7642

<b>SEK ART. 7631</b>	<b>WOOD</b>	
WOOD LEGS	8121	
<b>SHIPMENT DETAILS</b>	<b>TECHNICAL SPECIFICATIONS</b>	<b>RESISTANCE TEST</b>
<b>Art.7631</b> 1 pz = 2  - kg 8,58/ m³ 0,318 4 pz = 5  - kg 30,66/ m³ 1,042 		
<b>FIRE RETARDANT TEST</b>		

Frame Base

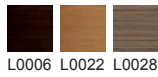

L0006 L0022 L0028

Shell



L0006 L0022 L0028



# Aava 02 Counter Stool

Design by Antti Kotilainen, 2023

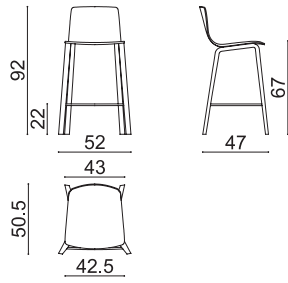

Stool on a 4-leg base in plywood with a reconstituted oak or walnut finish. Shell in wood upholstered with fabric, leather, coated fabric or customer's own material. The upholstery can be separated and replaced by technical personnel, since it has been applied without the use of glue. Glides are also available, with felt insert for wood floors. Seat height 67 cm.

SEK ART. 7639	A	B	C	D	E	F	G	H	I	J	K	L	M	ES
WOOD LEGS	8871	9145	9419	9693	9967	10241	10515	10789	11063	11337	11611	11885	12159	13467
<b>SHIPMENT DETAILS</b>	<b>TECHNICAL SPECIFICATIONS</b>				<b>RESISTANCE TEST</b>									
<b>Art.7639</b> 1 pz = 2  - kg 8,58/ m³ 0,362 4 pz = 5  - kg 30,66/ m³ 1,086 KD	<b>Art.7639</b> COL requirement m² 1.86 H 140 cm. COM Meterage m 0.814													
<b>FIRE RETARDANT TEST</b>														

Frame Base

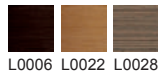



# Aava 02 Bar Stool

Design by Antti Kotilainen, 2023

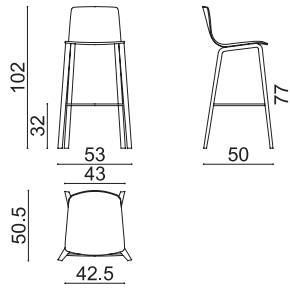

Stool on a 4-leg base in plywood with a reconstituted oak or walnut finish. Shell in wood upholstered with fabric, leather, coated fabric or customer's own material. The upholstery can be separated and replaced by technical personnel, since it has been applied without the use of glue. Glides are also available, with felt insert for wood floors. Seat height 77 cm.

SEK ART. 7640	A	B	C	D	E	F	G	H	I	J	K	L	M	ES
WOOD LEGS	8871	9145	9419	9693	9967	10241	10515	10789	11063	11337	11611	11885	12159	13467
<b>SHIPMENT DETAILS</b>	<b>TECHNICAL SPECIFICATIONS</b>				<b>RESISTANCE TEST</b>									
<b>Art.7640</b> 1 pz = 2  - kg 8,58/ m³ 0,362 4 pz = 5  - kg 30,66/ m³ 1,086 	<b>Art.7640</b> COL requirement m² 1.86 H 140 cm. COM Meterage m 0.814													
<b>FIRE RETARDANT TEST</b>														

Frame Base

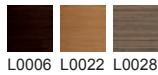



## Accessories

Design by Antti Kotilainen, 2023

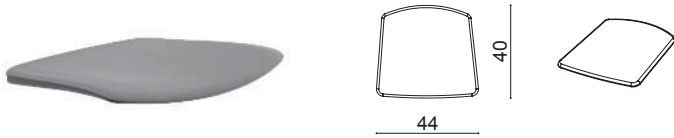
Seat cushion upholstered with fabric, leather, coated fabric or customer's own material. The accessory, suitable for indoor use, can be combined with the chair versions with exposed plastic shell and exposed wood shell.



SEK ART. 7641	A	B	C	D	E	F	G	H	I	J	K	L	M	ES
Cushion	1361	1509	1657	1805	1953	2101	2249	2397	2545	2693	2841	2989	3137	3720
<b>SHIPMENT DETAILS</b>	<b>TECHNICAL SPECIFICATIONS</b>				<b>RESISTANCE TEST</b>									
<b>Art.7641</b> 1 pz = 1  - kg 1,2/ m² 0,023 4 pz = 1  - kg 2,9/ m² 0,072														
<b>FIRE RETARDANT TEST</b>														



# Accessories

Design by Antti Kotilainen, 2023

Seat cushion upholstered with fabric, leather, coated fabric or customer's own material. The accessory, suitable for indoor use, can be combined with the stool versions with wood shell.

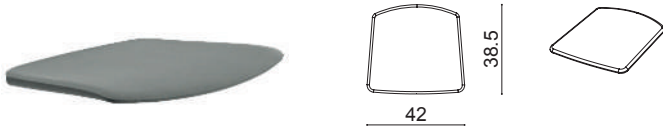

SEK ART. 7642	A	B	C	D	E	F	G	H	I	J	K	L	M	ES
Cushion	1361	1509	1657	1805	1953	2101	2249	2397	2545	2693	2841	2989	3137	3720
<b>SHIPMENT DETAILS</b>	<b>TECHNICAL SPECIFICATIONS</b>				<b>RESISTANCE TEST</b>									
Art.7642 4 pz = 1  - kg 2,9/ m² 0,072														
<b>FIRE RETARDANT TEST</b>														





## Accessories

Design by Antti Kotilainen, 2023

Removable upholstery in fabric, leather, coated fabric or customer's own material. The accessory, which can be combined with the chair or stool versions on 4-leg, sled, trestle with or without casters base equipped with exposed plastic shell, is suitable for indoor use.









SEK ART. 7643	A	B	C	D	E	F	G	H	I	J	K	L	M	ES
Cover	2608	2937	3266	3595	3924	4253	4582	4911	5240	5569	5898	6227	6556	7870
<b>SHIPMENT DETAILS</b>	<b>TECHNICAL SPECIFICATIONS</b>				<b>RESISTANCE TEST</b>									
<b>Art.7643</b> 1 pz = 1  - kg 3/ m <sup>3</sup> 0,021 4 pz = 1  - kg 8/ m <sup>3</sup> 0,073														
<b>FIRE RETARDANT TEST</b>														



# Accessories

Design by Antti Kotilainen

<p><b>SEK ART. 0500</b></p>  <p>Trolley (Aava 02, Catifa 46, Catifa 53, Juno 02, Mixu)</p>	<p><b>SEK ART. 3941</b></p>  <p>Link (only for wood shell and with Art. 3942)</p>	<p><b>SEK ART. 3942</b></p>  <p>Stacking protection Pad (only for wood shell)</p>	<p><b>SEK ART. 3948</b></p>  <p>Set of glides (white or black)</p>	<p><b>SEK ART. 3950</b></p>  <p>Stacking protection Pad (for polypropylene shell with front upholstery)</p>
4549	524	417	202	417
<p><b>SEK ART. 3970</b></p>  <p>Link (for polypropylene shell)</p>				
524				

SHIPMENT DETAILS	TECHNICAL SPECIFICATIONS	RESISTANCE TEST
<p><b>Art. 3941</b> 1 pz = 1  - kg 0,73/ m³ 0,006</p> <p><b>Art. 3942</b> 1 pz = 1  - kg 1,02/ m³ 0,037 4 pz = 1  - kg 2,66/ m³ 0,037</p> <p><b>Art. 3950</b> 1 pz = 1  - kg 1,02/ m³ 0,13 4 pz = 1  - kg 2,66/ m³ 0,076</p> <p><b>Art. 3970</b> 1 pz = 1  - kg 0,73/ m³ 0,006</p>		
<b>FIRE RETARDANT TEST</b>		



# ADELL

---

Design by Lievore + Altherr Désile Park

2020



# Adell

## Collection overview

---

### Bases



4 legs



Sled



4 wood legs

---

### Shell

#### Chair version



Polypropylene

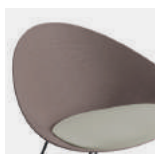

Polypropylene with  
seat cushion

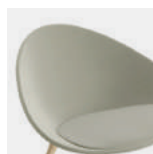

Upholstered with  
non-removable cover

---

#### Removable version

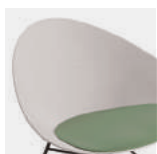

Removable seat cushion  
Indoor / Outdoor



Removable front cover  
Indoor / Outdoor

---

### Sewing scheme

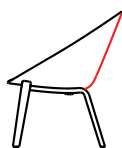
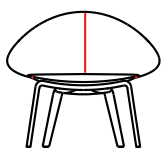
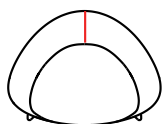

Leather upholstered



Outdoor

---

## New Fabrics

To emphasize the gentle shapes of Adell, we have added one further proposal to the wide range of Arper fabrics. Atom by Kvadrat is exclusively dedicated to Adell.



**Atom — Kvadrat Raf Simons**

6 colors



# Adell

Design by Lievore + Altherr Désile Park, 2020

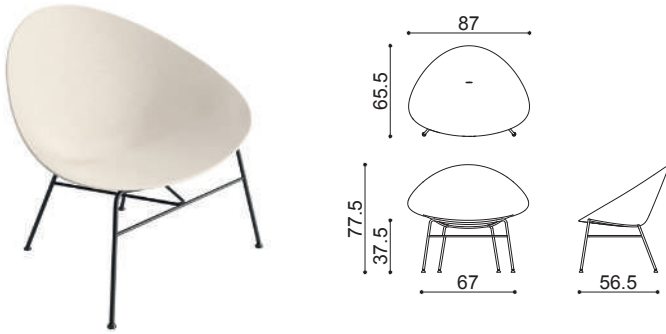

Lounge chair on a four-legged base in powder-coated steel. Polypropylene shell with distinctive texture made with 80% recycled materials, available in four colours. Hole on shell to allow water drainage.

**Accessories:**

Cushion - Indoor Art. 6809

Cushion - Outdoor Art. 6810

Front removable cushion - Indoor Art. 6811

Front removable cushion - Outdoor Art. 6812

<b>SEK ART. 6800</b>	<b>PD</b>	
POWDERCOATED	4954	

SHIPMENT DETAILS	TECHNICAL SPECIFICATIONS	RESISTANCE TEST
<b>Art.6800</b> 1 pz = 2  - kg 13,7/ m³ 0,501 4 pz = 2  - kg 38,8/ m³ 0,887		<ul style="list-style-type: none"> <li>• EN 1728:2012 - EN 16139:2013 6.10</li> <li>• EN 1728:2012 - EN 16139:2013 6.15</li> <li>• EN 1728:2012 - EN 16139:2013 6.17</li> <li>• EN 1728:2012 - EN 16139:2013 6.20</li> <li>• EN 1728:2012 - EN 16139:2013 6.25</li> <li>• EN 1728:2012 - EN 16139:2013 6.4</li> <li>• EN 1022:2018</li> </ul> <ul style="list-style-type: none"> <li>• EN 1728:2012 - EN 16139:2013 6.11</li> <li>• EN 1728:2012 - EN 16139:2013 6.16</li> <li>• EN 1728:2012 - EN 16139:2013 6.18</li> <li>• EN 1728:2012 - EN 16139:2013 6.24</li> <li>• EN 1728:2012 - EN 16139:2013 6.26</li> <li>• EN 1728:2012 - EN 16139:2013 6.5</li> <li>• ANSI/BIFMA X5.4-2020/24</li> </ul>
<b>FIRE RETARDANT TEST</b>		

**Frame Base**

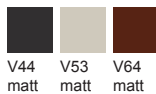

V44 V53 V64  
matt matt matt

**Shell**



PD00001 PD00002 PD00003 PD00004



Outdoor use

# Adell

Design by Lievore + Altherr Désile Park, 2020

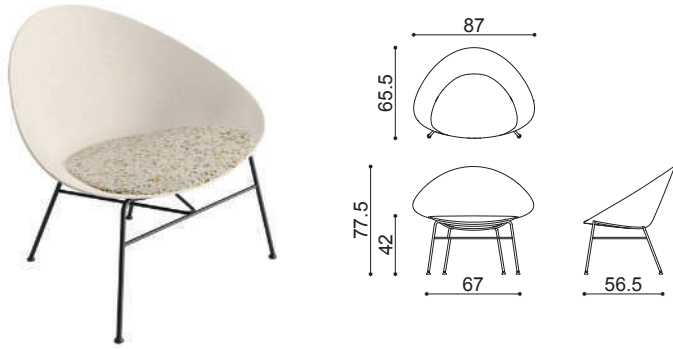

Lounge chair on a four-legged base in powder-coated steel. Polypropylene shell with distinctive texture made with 80% recycled materials, available in four colours, featuring a cushion attached to the seat covered with fabric, leather, coated fabric or a covering of the client's choice.

SEK ART. 6801	A	B COM	C COL	D	E	F	G	H	I	J	K	L	M	ES
POWDERCOATED	5776	6002	6228	6454	6680	6906	7132	7358	7584	7810	8036	8262	8488	9300
<b>SPECIAL FABRICS</b>	Atom													
POWDERCOATED	8488													

SHIPMENT DETAILS	TECHNICAL SPECIFICATIONS	RESISTANCE TEST
<b>Art.6801</b> 1 pz = 2  - kg 15,5/ m³ 0,501 4 pz = 2  - kg 46/ m³ 0,887	<b>Art.6801</b> COL requirement m² 1.02 H 140 cm. COM Meterage m 0.69	
<b>FIRE RETARDANT TEST</b>		

## Frame Base

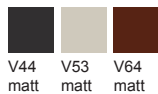

V44 V53 V64  
matt matt matt

## Shell



PD00001 PD00002 PD00003 PD00004



# Adell

Design by Lievore + Altherr Désile Park, 2020

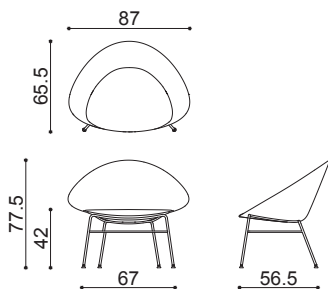

Lounge chair on a four-legged base in powder-coated steel. Polypropylene shell with distinctive texture made with 80% recycled materials, entirely covered with fabric, leather, coated fabric or a covering of the client's choice.

SEK ART. 6802	A	B COM	C COL	D	E	F	G	H	I	J	K	L	M	ES
POWDERCOATED	10324	10931	11538	12145	12752	13359	13966	14573	15180	15787	16394	17001	17608	20004
<b>SPECIAL FABRICS</b>	Atom													
POWDERCOATED	17608													

SHIPMENT DETAILS	TECHNICAL SPECIFICATIONS	RESISTANCE TEST
<b>Art.6802</b> 1 pz = 2  - kg 16,4/ m³ 0,501 4 pz = 2  - kg 49,6/ m³ 0,887	<b>Art.6802</b> COL requirement m² 3.84 H 140 cm. COM Meterage m 1.96 *Classe 1, 2, 11M: fire retardant version available with surcharge and eventual minimum batch	
<b>FIRE RETARDANT TEST</b> Classe 11M Omologazione Italia Remix 3 Kvadrat. • FIRE RETARDANT VERSION WITH SURCHARGE * Classe 11M Omologazione Italia Coated fabric Valencia Spradling.		

## Frame Base

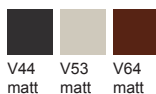

# Adell

Design by Lievore + Altherr Désile Park, 2020

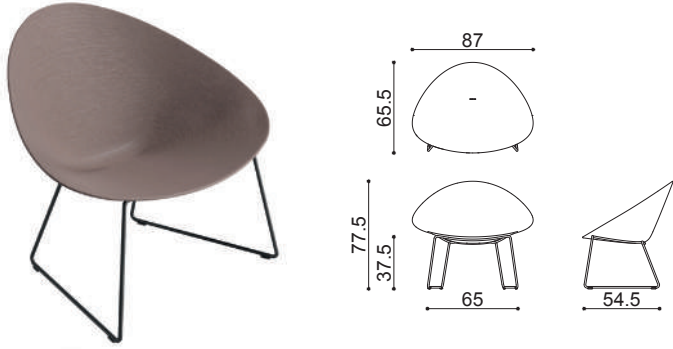

Lounge chair with powder-coated steel sled base. Polypropylene shell with distinctive texture made with 80% recycled materials, available in four colours. Hole on shell to allow water drainage.

**Accessories:**

Cushion - Indoor Art. 6809

Cushion - Outdoor Art. 6810

Front removable cushion - Indoor Art. 6811

Front removable cushion - Outdoor Art. 6812

<b>SEK ART. 6803</b>	<b>PD</b>	
POWDERCOATED	5215	

SHIPMENT DETAILS	TECHNICAL SPECIFICATIONS	RESISTANCE TEST
<b>Art.6803</b> 1 pz = 2  - kg 14,3/ m³ 0,501 4 pz = 2  - kg 40,4/ m³ 0,793		<ul style="list-style-type: none"> <li>• EN 1728:2012 - EN 16139:2013 6.10</li> <li>• EN 1728:2012 - EN 16139:2013 6.15</li> <li>• EN 1728:2012 - EN 16139:2013 6.17</li> <li>• EN 1728:2012 - EN 16139:2013 6.20</li> <li>• EN 1728:2012 - EN 16139:2013 6.25</li> <li>• EN 1728:2012 - EN 16139:2013 6.4</li> <li>• EN 1022:2018</li> </ul> <ul style="list-style-type: none"> <li>• EN 1728:2012 - EN 16139:2013 6.11</li> <li>• EN 1728:2012 - EN 16139:2013 6.16</li> <li>• EN 1728:2012 - EN 16139:2013 6.18</li> <li>• EN 1728:2012 - EN 16139:2013 6.24</li> <li>• EN 1728:2012 - EN 16139:2013 6.26</li> <li>• EN 1728:2012 - EN 16139:2013 6.5</li> </ul>
<b>FIRE RETARDANT TEST</b>		

**Frame Base**

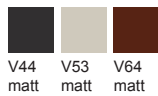

V44 V53 V64  
matt matt matt

**Shell**



PD00001 PD00002 PD00003 PD00004



Outdoor use

# Adell

Design by Lievore + Altherr Désile Park, 2020

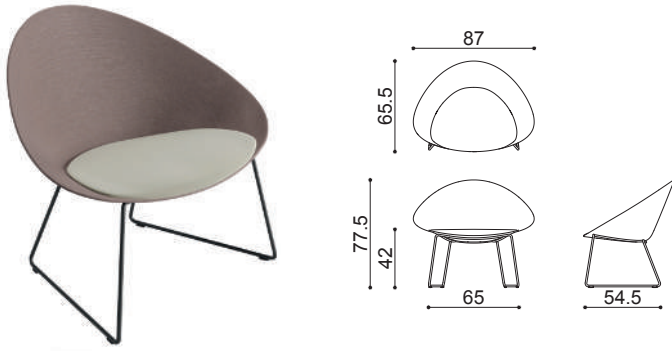

Lounge chair with powder-coated steel sled base. Polypropylene shell with distinctive texture made with 80% recycled materials, available in four colours, featuring a cushion attached to the seat covered with fabric, leather, coated fabric or a covering of the client's choice.

SEK ART. 6804	A	B COM	C COL	D	E	F	G	H	I	J	K	L	M	ES
POWDERCOATED	6037	6263	6489	6715	6941	7167	7393	7619	7845	8071	8297	8523	8749	9561
<b>SPECIAL FABRICS</b>	Atom													
POWDERCOATED	8749													

SHIPMENT DETAILS	TECHNICAL SPECIFICATIONS	RESISTANCE TEST
<b>Art.6804</b> 1 pz = 2  - kg 16,1/ m³ 0,501 4 pz = 2  - kg 47,6/ m³ 0,793	<b>Art.6804</b> COL requirement m² 1.02 H 140 cm. COM Meterage m 0.69	
<b>FIRE RETARDANT TEST</b>		

Frame Base

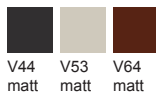

V44 V53 V64  
matt matt matt

Shell



PD00001 PD00002 PD00003 PD00004



# Adell

Design by Lievore + Altherr Désile Park, 2020

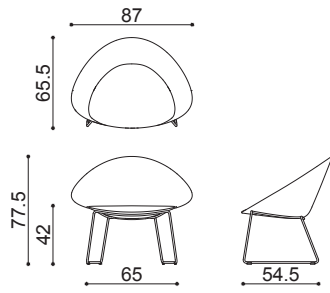

Lounge chair with powder-coated steel sled base. Polypropylene shell with distinctive texture made with 80% recycled materials, entirely covered with fabric, leather, coated fabric or a covering of the client's choice.

SEK ART. 6805	A	B COM	C COL	D	E	F	G	H	I	J	K	L	M	ES
POWDERCOATED	10585	11192	11799	12406	13013	13620	14227	14834	15441	16048	16655	17262	17869	20265
<b>SPECIAL FABRICS</b>	Atom													
POWDERCOATED	17869													

SHIPMENT DETAILS	TECHNICAL SPECIFICATIONS	RESISTANCE TEST
<b>Art.6805</b> 1 pz = 2  - kg 17/ m³ 0,501 4 pz = 2  - kg 51,2/ m³ 0,793	<b>Art.6805</b> COL requirement m² 3.84 H 140 cm. COM Meterage m 1.96 *Classe 1, 2, 1IM: fire retardant version available with surcharge and eventual minimum batch	
<b>FIRE RETARDANT TEST</b> Classe 1IM Omologazione Italia Remix 3 Kvadrat. • FIRE RETARDANT VERSION WITH SURCHARGE * Classe 1IM Omologazione Italia Coated fabric Valencia Spradling.		

## Frame Base

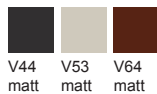

# Adell

Design by Lievore + Altherr Désile Park, 2020

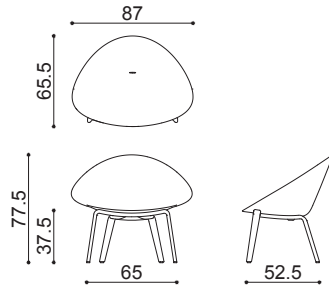

Lounge chair on a four-legged base in plywood with a reconstituted natural or dyed oak finish. Polypropylene shell with distinctive texture made with 80% recycled materials, available in four colours.

Accessories:  
Cushion - Indoor Art. 6809  
Front removable cushion - Indoor Art. 6811

<b>SEK ART. 6806</b>	<b>PD</b>	
WOOD	6537	

SHIPMENT DETAILS	TECHNICAL SPECIFICATIONS	RESISTANCE TEST
<b>Art.6806</b> 1 pz = 2  - kg 12,2/ m³ 0,457 4 pz = 2  - kg 34,4/ m³ 0,809		<ul style="list-style-type: none"> <li>• EN 1728:2012 - EN 16139:2013 6.10</li> <li>• EN 1728:2012 - EN 16139:2013 6.15</li> <li>• EN 1728:2012 - EN 16139:2013 6.17</li> <li>• EN 1728:2012 - EN 16139:2013 6.20</li> <li>• EN 1728:2012 - EN 16139:2013 6.25</li> <li>• EN 1728:2012 - EN 16139:2013 6.4</li> <li>• EN 1022:2018</li> </ul>
		<ul style="list-style-type: none"> <li>• EN 1728:2012 - EN 16139:2013 6.11</li> <li>• EN 1728:2012 - EN 16139:2013 6.16</li> <li>• EN 1728:2012 - EN 16139:2013 6.18</li> <li>• EN 1728:2012 - EN 16139:2013 6.24</li> <li>• EN 1728:2012 - EN 16139:2013 6.26</li> <li>• EN 1728:2012 - EN 16139:2013 6.5</li> <li>• EN 1728:2012 - EN 12520:2015 5.4.2</li> </ul>
<b>FIRE RETARDANT TEST</b>		

Frame Base



L0006 L0022

Shell



PD00001 PD00002 PD00003 PD00004



# Adell

Design by Lievore + Altherr Désile Park, 2020

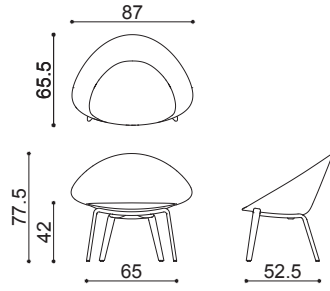

Lounge chair on a four-legged base in plywood with a reconstituted natural or dyed oak finish. Polypropylene shell with distinctive texture made with 80% recycled materials, available in four colours, featuring a cushion attached to the seat covered with fabric, leather, coated fabric or a covering of the client's choice.

SEK ART. 6807	A	B COM	C COL	D	E	F	G	H	I	J	K	L	M	ES
WOOD	7359	7585	7811	8037	8263	8489	8715	8941	9167	9393	9619	9845	10071	10883
SPECIAL FABRICS	Atom													
WOOD	10071													

SHIPMENT DETAILS	TECHNICAL SPECIFICATIONS	RESISTANCE TEST
<b>Art.6807</b> 1 pz = 2  - kg 14/ m³ 0,457 4 pz = 2  - kg 42/ m³ 0,809	<b>Art.6807</b> COL requirement m² 1.02 H 140 cm. COM Meterage m 0.69	
FIRE RETARDANT TEST		

Frame Base

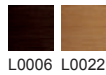

L0006 L0022

Shell



PD00001 PD00002 PD00003 PD00004





# Adell

Design by Lievore + Altherr Désile Park, 2020

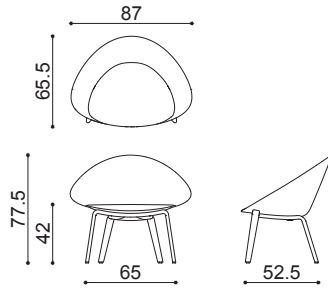

Lounge chair on a four-legged base in plywood with a reconstituted natural or dyed oak finish. Polypropylene shell with distinctive texture made with 80% recycled materials, entirely covered with fabric, leather, coated fabric or a covering of the client's choice.

SEK ART. 6808	A	B COM	C COL	D	E	F	G	H	I	J	K	L	M	ES
WOOD	11907	12514	13121	13728	14335	14942	15549	16156	16763	17370	17977	18584	19191	21587
<b>SPECIAL FABRICS</b>	Atom													
WOOD	19191													

SHIPMENT DETAILS	TECHNICAL SPECIFICATIONS	RESISTANCE TEST
<b>Art.6808</b> 1 pz = 2  - kg 14/ m³ 0,457 4 pz = 2  - kg 45,6/ m³ 0,809	<b>Art.6808</b> COL requirement m² 3.84 H 140 cm. COM Meterage m 1.96 *Classe 1, 2, 1IM: fire retardant version available with surcharge and eventual minimum batch	
<b>FIRE RETARDANT TEST</b> Classe 1IM Omologazione Italia Remix 3 Kvadrat. • FIRE RETARDANT VERSION WITH SURCHARGE * Classe 1IM Omologazione Italia Coated fabric Valencia Spradling.		

Frame Base





## Accessories

Design by Lievore + Altherr Désile Park, 2020

Seat cushion covered with fabric, leather, coated fabric or a covering of the client's choice. The accessory – to be paired with the chair featuring exposed plastic shell – is removable and is available in both indoor (Art. 6809) and outdoor (Art. 6810) versions.



SEK ART. 6809	A	B COM	C COL	D	E	F	G	H	I	J	K	L	M	ES
CUSHION - INDOOR	1310	1512	1714	1916	2118	2320	2522	2724	2926	3128	3330	3532	3734	4393
<b>SPECIAL FABRICS</b>	Atom													
CUSHION - INDOOR	3734													

SHIPMENT DETAILS	TECHNICAL SPECIFICATIONS	RESISTANCE TEST
<b>Art.6809</b> 1 pz = 1  - kg 1/ m³ 0,018 4 pz = 1  - kg 4,22/ m³ 0,099	<b>Art.6809</b> COL requirement m² 1.14 H 140 cm. COM Meterage m 0.61	
<b>FIRE RETARDANT TEST</b> Classe 1IM Omologazione Italia Remix 3 Kvadrat.		





## Accessories

Design by Lievore + Altherr Désile Park, 2020

Seat cushion covered with fabric, leather, coated fabric or a covering of the client's choice. The accessory – to be paired with the chair featuring exposed plastic shell – is removable and is available in both indoor (Art. 6809) and outdoor (Art. 6810) versions.



<b>SEK ART. 6810</b>	COM	Heritage Savane Silvertex	Patio	
CUSHION - OUTDOOR	1726	1928	2130	

SHIPMENT DETAILS	TECHNICAL SPECIFICATIONS	RESISTANCE TEST
<b>Art.6810</b> 1 pz = 1  - kg 1/ m³ 0,018 4 pz = 1  - kg 4,22/ m³ 0,099	<b>Art.6810</b> H 140 cm. COM Meterage m 0.61	
<b>FIRE RETARDANT TEST</b>		



Outdoor use



## Accessories

Design by Lievore + Altherr Désile Park, 2020

Front cushion covered with fabric or a covering of the client's choice. The accessory – to be paired with the chair featuring exposed plastic shell – is removable and is available in both indoor (Art. 6811) and outdoor (Art. 6812) versions.



SEK ART. 6811	A	B COM	C	D	E	F	G	H	I	J	K	L	M	
FRONT REMOVABLE CUSHION - INDOOR	3573	4002	4431	4860	5289	5718	6147	6576	7005	7434	7863	8292	8721	
<b>SPECIAL FABRICS</b>	Atom													
FRONT REMOVABLE CUSHION - INDOOR	8721													

SHIPMENT DETAILS	TECHNICAL SPECIFICATIONS	RESISTANCE TEST
<b>Art.6811</b> 1 pz = 1  - kg 3,1/ m² 0,084 4 pz = 1  - kg 9,5/ m² 0,385	<b>Art.6811</b> COL requirement m² H 140 cm. COM Meterage m 1.42	
<b>FIRE RETARDANT TEST</b> Classe 1IM Omologazione Italia Remix 3 Kvadrat. Coated fabric Valencia Spradling.		





## Accessories

Design by Lievore + Altherr Désile Park, 2020

Front cushion covered with fabric or a covering of the client's choice. The accessory – to be paired with the chair featuring exposed plastic shell – is removable and is available in both indoor (Art. 6811) and outdoor (Art. 6812) versions.



<b>SEK ART. 6812</b>	COM	Heritage Savane	Patio	
FRONT REMOVABLE CUSHION - OUTDOOR	4894	5323	5752	

SHIPMENT DETAILS	TECHNICAL SPECIFICATIONS	RESISTANCE TEST
<b>Art.6812</b> 1 pz = 1  - kg 3,1/ m <sup>2</sup> 0,084 4 pz = 1  - kg 9,5/ m <sup>2</sup> 0,385	<b>Art.6812</b> H 140 cm. COM Meterage m 1.41	
<b>FIRE RETARDANT TEST</b>		



Outdoor use

# ASTON

---

Design by Jean-Marie Massaud

2006



# Aston

## Collection overview

---

### Bases



4 way swivel



5 ways



5 way synchro



Lounge



Footrest

---

### Backrest



Low



Medium



High

### Return mechanism

### Synchro mechanism



# Aston Lounge

Design by Jean-Marie Massaud, 2006

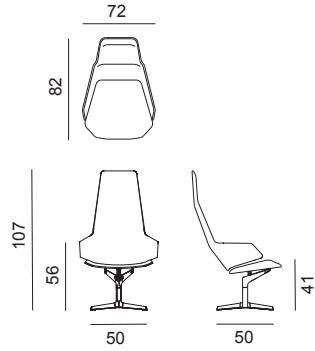

Lounge armchair with aluminium pedestal base. Aston Lounge is available in two versions: with swivel base (Art. 1920), or fitted with seat return mechanism (Art. 1921). The shell support and the spring providing tilt movement are available in the same finishes of the base. The polyurethane shell is upholstered in leather, coated fabric, fabric, or customer's material.

SEK ART. 1920	A	B COM	C COL	D	E	F	G	H	I	J	K	L	M	ES
SWIVEL BASE	17789	18694	19599	20504	21409	22314	23219	24124	25029	25934	26839	27744	28649	32244
SEK ART. 1921	A	B COM	C COL	D	E	F	G	H	I	J	K	L	M	ES
RETURN MECHANISM	19551	20456	21361	22266	23171	24076	24981	25886	26791	27696	28601	29506	30411	34018
Fire retardant foam	+ 1286													

SHIPMENT DETAILS	TECHNICAL SPECIFICATIONS	RESISTANCE TEST
<b>Art.1920</b> 1 pz = 1  - kg 28,5/ m³ 0,958 <b>Art.1921</b> 1 pz = 1  - kg 29/ m³ 0,958	<b>Art.1920</b> COL requirement m² 4.68 H 140 cm. COM Meterage m 2.31 <b>Art.1921</b> COL requirement m² 4.68 H 140 cm. COM Meterage m 2.31	

**FIRE RETARDANT TEST**  
 Classe 1IM Omologazione Italia Divina MD Kvadrat. Divina Melange 3 Kvadrat. Divina 3 Kvadrat. Elmosoft. Field Kvadrat. Hallingdal 65 Kvadrat. Remix 3 Kvadrat. Steelcut Trio 3 Kvadrat. Tonus 4 Kvadrat. Coated fabric Valencia Spradling.

Frame Base

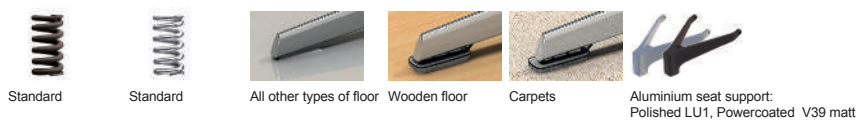
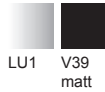



# Aston Lounge

Design by Jean-Marie Massaud, 2006

Footstool with aluminium pedestal base. The cushion support element is available in the same finishes of the base. The polyurethane shell is upholstered in fabric, leather, coated fabric or customer's material.

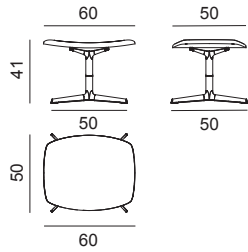

SEK ART. 1902	A	B COM	C COL	D	E	F	G	H	I	J	K	L	M	ES
POLISHED	8419	8788	9157	9526	9895	10264	10633	11002	11371	11740	12109	12478	12847	14288
Fire retardant foam	+ 143													

SHIPMENT DETAILS	TECHNICAL SPECIFICATIONS	RESISTANCE TEST
<b>Art.1902</b> 1 pz = 1  - kg 10,5/ m³ 0,157	<b>Art.1902</b> COL requirement m² 1.8 H 140 cm. COM Meterage m 1.27	

FIRE RETARDANT TEST
Classe 1IM Omologazione Italia Divina MD Kvadrat. Divina Melange 3 Kvadrat. Divina 3 Kvadrat. Elmosoft. Field Kvadrat. Hallingdal 65 Kvadrat. Tonus 4 Kvadrat. Coated fabric Valencia Spradling.

Frame Base



All other types of floor Wooden floor Carpets



# Aston

Design by Jean-Marie Massaud, 2007

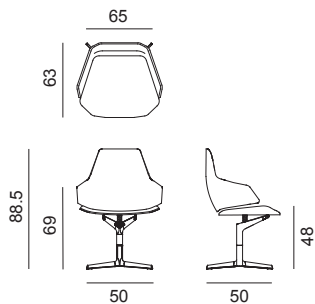

Armchair with aluminium pedestal swivel base, also available with the seat return mechanism (Art. 1929). The shell support and the spring providing tilt movement are available in the same finishes of the base. The polyurethane shell is upholstered in leather, coated fabric, fabric, or customer's material.

SEK ART. 1928	A	B COM	C COL	D	E	F	G	H	I	J	K	L	M	ES
SWIVEL BASE	15372	16015	16658	17301	17944	18587	19230	19873	20516	21159	21802	22445	23088	25648
SEK ART. 1929	A	B COM	C COL	D	E	F	G	H	I	J	K	L	M	ES
RETURN MECHANISM	17146	17789	18432	19075	19718	20361	21004	21647	22290	22933	23576	24219	24862	27410
Fire retardant foam	+ 917													

SHIPMENT DETAILS	TECHNICAL SPECIFICATIONS	RESISTANCE TEST
<b>Art.1928</b> 1 pz = 1  - kg 16/ m³ 0,715 <b>Art.1929</b> 1 pz = 1  - kg 26,3/ m³ 0,715	<b>Art.1928</b> COL requirement m² 3.48 H 140 cm. COM Meterage m 1.65 <b>Art.1929</b> COL requirement m² 3.48 H 140 cm. COM Meterage m 1.65	

**FIRE RETARDANT TEST**  
 Classe 1IM Omologazione Italia Divina MD Kvadrat. Divina Melange 3 Kvadrat. Divina 3 Kvadrat. Elmosoft. Field Kvadrat. Hallingdal 65 Kvadrat. Remix 3 Kvadrat. Steelcut Trio 3 Kvadrat. Tonus 4 Kvadrat. Coated fabric Valencia Spradling.

Frame Base



# Aston

Design by Jean-Marie Massaud, 2006

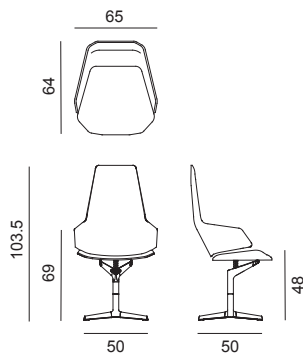

Armchair with aluminium pedestal swivel base (Art. 1925) also available with the seat return mechanism (Art. 1926). The shell support and the spring providing tilt movement are available in the same finishes of the base. The polyurethane shell is upholstered in leather, coated fabric, fabric, or customer's material.

SEK ART. 1925	A	B COM	C COL	D	E	F	G	H	I	J	K	L	M	ES
SWIVEL BASE	16063	16802	17541	18280	19019	19758	20497	21236	21975	22714	23453	24192	24931	27791
SEK ART. 1926	A	B COM	C COL	D	E	F	G	H	I	J	K	L	M	ES
RETURN MECHANISM	17824	18563	19302	20041	20780	21519	22258	22997	23736	24475	25214	25953	26692	29565
Fire retardant foam	+ 917													

SHIPMENT DETAILS	TECHNICAL SPECIFICATIONS	RESISTANCE TEST
<b>Art. 1925</b> 1 pz = 1  - kg 26,4/ m³ 0,715 <b>Art. 1926</b> 1 pz = 1  - kg 26,9/ m³ 0,715	<b>Art. 1925</b> COL requirement m² 4.08 H 140 cm. COM Meterage m 1.88  <b>Art. 1926</b> COL requirement m² 4.08 H 140 cm. COM Meterage m 1.88	

**FIRE RETARDANT TEST**  
 Classe 11M Omologazione Italia Divina MD Kvadrat. Divina Melange 3 Kvadrat. Divina 3 Kvadrat. Elmosoft. Field Kvadrat. Hallingdal 65 Kvadrat. Remix 3 Kvadrat. Steelcut Trio 3 Kvadrat. Tonus 4 Kvadrat. Coated fabric Valencia Spradling.

## Frame Base

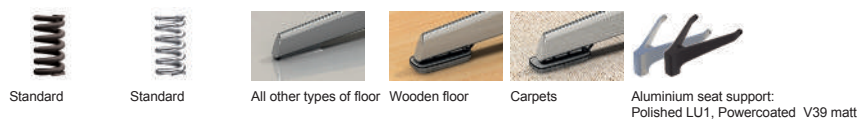

# Aston

Design by Jean-Marie Massaud, 2006

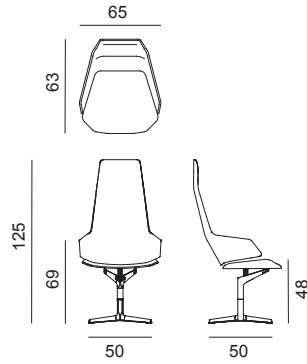

Executive armchair with aluminium pedestal swivel base (Art. 1922), also available with the seat return mechanism (Art. 1923). The shell support and the spring providing tilt movement are available in the same finishes of the base. The polyurethane shell is upholstered in leather, coated fabric, fabric, or customer's material.

SEK ART. 1922	A	B COM	C COL	D	E	F	G	H	I	J	K	L	M	ES
SWIVEL BASE	16884	17789	18694	19599	20504	21409	22314	23219	24124	25029	25934	26839	27744	31339
SEK ART. 1923	A	B COM	C COL	D	E	F	G	H	I	J	K	L	M	ES
RETURN MECHANISM	18670	19575	20480	21385	22290	23195	24100	25005	25910	26815	27720	28625	29530	33126
Fire retardant foam	+ 1095													

SHIPMENT DETAILS	TECHNICAL SPECIFICATIONS	RESISTANCE TEST
<b>Art. 1922</b> 1 pz = 1  - kg 27,8/ m³ 0,83 <b>Art. 1923</b> 1 pz = 1  - kg 27,5/ m³ 0,83	<b>Art. 1922</b> COL requirement m² 4.2 H 140 cm. COM Meterage m 2.09 <b>Art. 1923</b> COL requirement m² 4.2 H 140 cm. COM Meterage m 2.09	

**FIRE RETARDANT TEST**  
 Classe 1IM Omologazione Italia Divina MD Kvadrat. Divina Melange 3 Kvadrat. Divina 3 Kvadrat. Elmosoft. Field Kvadrat. Hallingdal 65 Kvadrat. Remix 3 Kvadrat. Steelcut Trio 3 Kvadrat. Tonus 4 Kvadrat. Coated fabric Valencia Spradling.

Frame Base

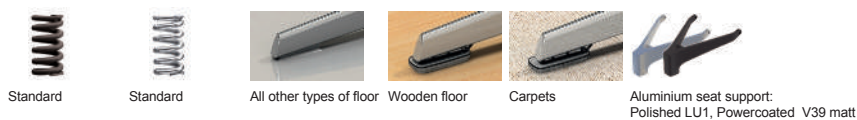
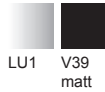

# Aston

Design by Jean-Marie Massaud, 2007

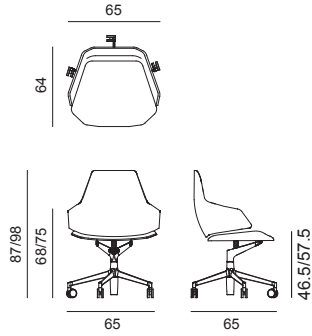

Armchair with aluminium five-star base mounted on self-braking castors, equipped with gas height adjustment mechanism. The shell support and the spring providing tilt movement are available in the same finishes of the base. The polyurethane shell is upholstered in leather, coated fabric, fabric, or customer's material.

SEK ART. 1930	A	B COM	C COL	D	E	F	G	H	I	J	K	L	M	ES
GAS MECHANISM	17539	18182	18825	19468	20111	20754	21397	22040	22683	23326	23969	24612	25255	27802
Fire retardant foam	+ 917													

SHIPMENT DETAILS	TECHNICAL SPECIFICATIONS	RESISTANCE TEST
<b>Art.1930</b> 1 pz = 1  - kg 27,5/ m³ 0,715	<b>Art.1930</b> COL requirement m² 3.48 H 140 cm. COM Meterage m 1.65	

**FIRE RETARDANT TEST**  
 Classe 1IM Omologazione Italia Divina MD Kvadrat. Divina Melange 3 Kvadrat. Divina 3 Kvadrat. Elmosoft. Field Kvadrat. Hallingdal 65 Kvadrat. Remix 3 Kvadrat. Steelcut Trio 3 Kvadrat. Tonus 4 Kvadrat. Coated fabric Valencia Spradling.

Frame Base



Aluminium seat support:  
 Polished LU1, Powercoated V39 matt



# Aston

Design by Jean-Marie Massaud, 2015

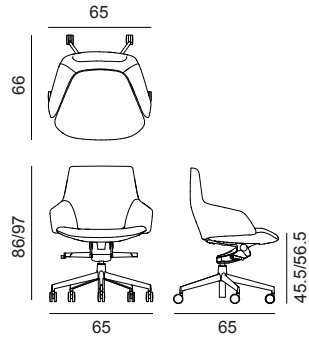

Armchair with aluminium five-star base mounted on self braking castors, equipped with gas height adjustment and synchro mechanism. The polyurethane shell is upholstered in leather, coated fabric, fabric or customer's material.

SEK ART. 1933	A	B COM	C COL	D	E	F	G	H	I	J	K	L	M	ES
SYNCHRO MECHANISM	18324	18978	19632	20286	20940	21594	22248	22902	23556	24210	24864	25518	26172	28803
Fire retardant foam	+ 917													
SHIPMENT DETAILS	TECHNICAL SPECIFICATIONS				RESISTANCE TEST									
Art.1933 1 pz = 1  - kg 28,5/ m³ 0,715	Art.1933 COL requirement m² 3.48 H 140 cm. COM Meterage m 1.62													
FIRE RETARDANT TEST														
Classe 1IM Omologazione Italia Field Kvadrat. Remix 3 Kvadrat. Steelcut Trio 3 Kvadrat. Coated fabric Valencia Spradling.														

Frame Base

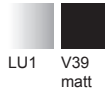

# Aston

Design by Jean-Marie Massaud, 2007

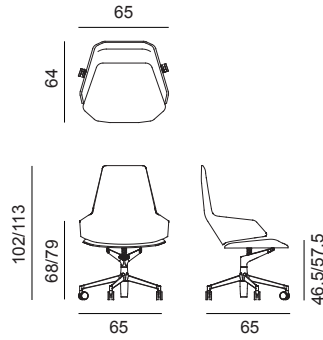

Armchair with aluminium five-star base mounted on self-braking castors, equipped with gas height adjustment mechanism. The shell support and the spring providing tilt movement are available in the same finishes of the base. The polyurethane shell is upholstered in leather, coated fabric, fabric, or customer's material.

SEK ART. 1927	A	B COM	C COL	D	E	F	G	H	I	J	K	L	M	ES
GAS MECHANISM	18182	18921	19660	20399	21138	21877	22616	23355	24094	24833	25572	26311	27050	29911
Fire retardant foam	+ 917													

SHIPMENT DETAILS	TECHNICAL SPECIFICATIONS	RESISTANCE TEST
<b>Art.1927</b> 1 pz = 1  - kg 28/ m³ 0,715	<b>Art.1927</b> COL requirement m² 4.08 H 140 cm. COM Meterage m 1.88	

**FIRE RETARDANT TEST**  
 Classe 1IM Omologazione Italia Divina MD Kvadrat. Divina Melange 3 Kvadrat. Divina 3 Kvadrat. Elmosoft. Field Kvadrat. Hallingdal 65 Kvadrat. Remix 3 Kvadrat. Steelcut Trio 3 Kvadrat. Tonus 4 Kvadrat. Coated fabric Valencia Spradling.

Frame Base



# Aston

Design by Jean-Marie Massaud, 2009

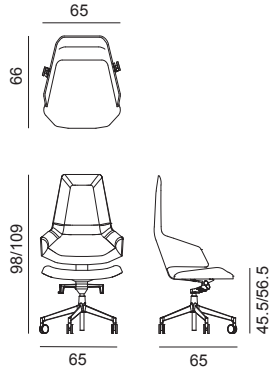

Armchair with aluminium five-star base mounted on self braking castors, equipped with gas height adjustment and synchro mechanism. The polyurethane shell is upholstered in leather, coated fabric, fabric or customer's material.

SEK ART. 1918	A	B COM	C COL	D	E	F	G	H	I	J	K	L	M	ES
SYNCHRO MECHANISM	18968	19754	20540	21326	22112	22898	23684	24470	25256	26042	26828	27614	28400	31541
Fire retardant foam	+ 917													
SHIPMENT DETAILS	TECHNICAL SPECIFICATIONS				RESISTANCE TEST									
<b>Art.1918</b> 1 pz = 1  - kg 29/ m² 0,715	<b>Art.1918</b> COL requirement m² 3.72 H 140 cm. COM Meterage m 1.83													
FIRE RETARDANT TEST														
Classe 1IM Omologazione Italia Divina MD Kvadrat. Divina Melange 3 Kvadrat. Divina 3 Kvadrat. Elmosoft. Field Kvadrat. Hallingdal 65 Kvadrat. Tonus 4 Kvadrat. Coated fabric Valencia Spradling.														

Frame Base

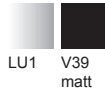

Synchro





# Aston

Design by Jean-Marie Massaud, 2007

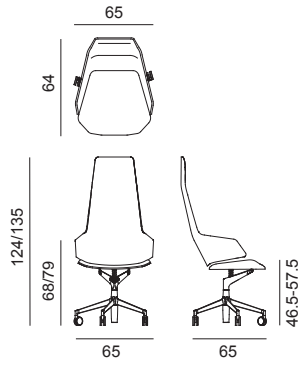

Executive armchair with aluminium five-star base mounted on selfbraking castors, equipped with gas height adjustment mechanism. The shell support and the spring providing tilt movement are available in the same finishes of the base. The polyurethane shell is upholstered in leather, coated fabric, fabric, or customer's material.

SEK ART. 1924	A	B COM	C COL	D	E	F	G	H	I	J	K	L	M	ES
GAS MECHANISM	19004	19909	20814	21719	22624	23529	24434	25339	26244	27149	28054	28959	29864	33470
Fire retardant foam	+ 1095													

SHIPMENT DETAILS	TECHNICAL SPECIFICATIONS	RESISTANCE TEST
<b>Art.1924</b> 1 pz = 1  - kg 29,5/ m³ 0,83	<b>Art.1924</b> COL requirement m² 4.2 H 140 cm. COM Meterage m 2.09	

**FIRE RETARDANT TEST**  
 Classe 1IM Omologazione Italia Divina MD Kvadrat. Divina Melange 3 Kvadrat. Divina 3 Kvadrat. Elmosoft. Field Kvadrat. Hallingdal 65 Kvadrat. Remix 3 Kvadrat. Steelcut Trio 3 Kvadrat. Tonus 4 Kvadrat. Coated fabric Valencia Spradling.

Frame Base



Standard



Standard



Aluminium seat support:  
 Polished LU1, Powercoated V39 matt



# Aston

Design by Jean-Marie Massaud, 2009

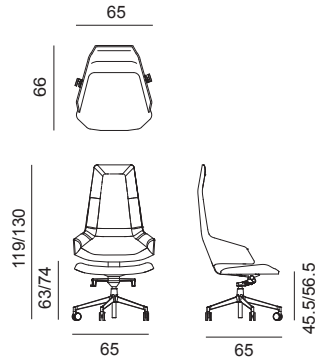

Armchair with aluminium five-star base mounted on self braking castors, equipped with gas height adjustment and synchro mechanisms. The polyurethane shell is upholstered in leather, coated fabric, fabric or customer's material.

SEK ART. 1919	A	B COM	C COL	D	E	F	G	H	I	J	K	L	M	ES
SYNCHRO MECHANISM	19814	20624	21434	22244	23054	23864	24674	25484	26294	27104	27914	28724	29534	32816
Fire retardant foam	+ 1095													
SHIPMENT DETAILS	TECHNICAL SPECIFICATIONS				RESISTANCE TEST									
<b>Art.1919</b> 1 pz = 1  - kg 30,5/ m³ 0,83	<b>Art.1919</b> COL requirement m² 4.08 H 140 cm. COM Meterage m 2.05				<ul style="list-style-type: none"> <li>• EN 1728:2012 - EN 16139:2013 6.10</li> <li>• EN 1728:2012 - EN 16139:2013 6.18</li> <li>• EN 1728:2012 - EN 16139:2013 6.24</li> <li>• EN 1728:2012 - EN 16139:2013 6.26</li> <li>• EN 1728:2012 - EN 16139:2013 6.5</li> </ul>					<ul style="list-style-type: none"> <li>• EN 1728:2012 - EN 16139:2013 6.11</li> <li>• EN 1728:2012 - EN 16139:2013 6.20</li> <li>• EN 1728:2012 - EN 16139:2013 6.25</li> <li>• EN 1728:2012 - EN 16139:2013 6.4</li> </ul>				
FIRE RETARDANT TEST														
Classe 1IM Omologazione Italia Divina MD Kvadrat. Divina Melange 3 Kvadrat. Divina 3 Kvadrat. Elmosoft. Field Kvadrat. Hallingdal 65 Kvadrat. Tonus 4 Kvadrat. Coated fabric Valencia Spradling.														

Frame Base



Synchro





# ASTON CLUB

---

Design by Jean-Marie Massaud

2020



# Aston Club

## Collection overview

---

### Bases



4 ways



4 ways



4 ways footrest

---

# Aston Club

## New Fabrics

To emphasize the striking and elegant gesture of Aston Club, we have added four further proposals to the wide range of Arper fabrics. Ria, Sonar 3 (Kvadrat) and Sera (Rohi) fabrics are dedicated exclusively to Aston Club, as well as Fabthirty by Rubelli which is shared with Shaal collection.

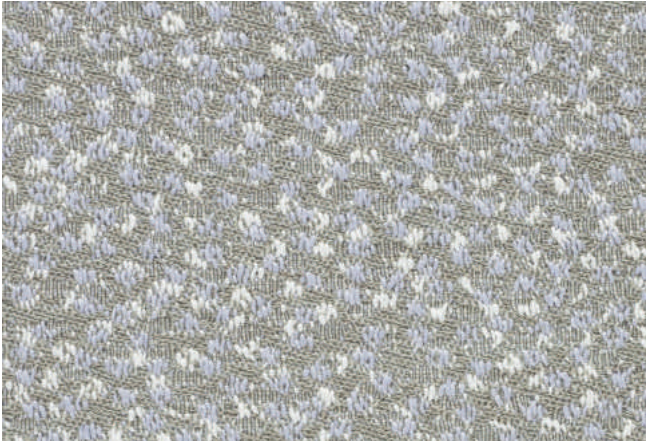

**Ria — Kvadrat Raf Simons**

15 colors



**Sonar 3 — Kvadrat Raf Simons**

17 colors

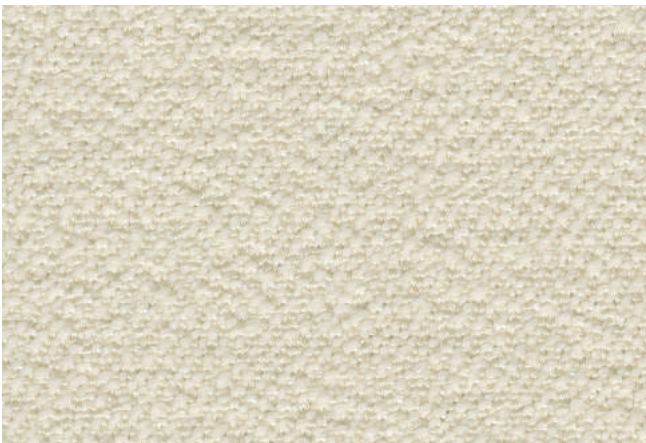

**Sera — Rohi**

26 colors



**Fabthirty — Rubelli**

60 colors

# Aston Club

Design by Jean-Marie Massaud, 2020

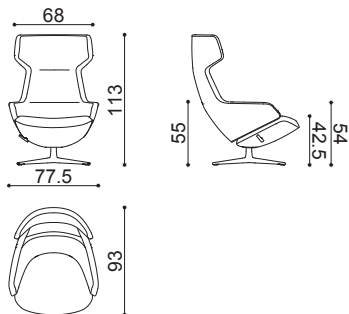

Lounge chair on a 4-ways base in polished or powder-coated aluminium, featuring a seat return mechanism and a weight-triggered mechanism for reclining the backrest, with three set positions. The polyurethane shell is covered with fabric, leather, coated fabric or a covering of the client's choice.

SEK ART. 2400	A	B COM	C COL	D	E	F	G	H	I	J	K	L	M	ES
	38365	39723	41081	42439	43797	45155	46513	47871	49229	50587	51945	53303	54661	60201
SPECIAL FABRICS	Fabthirty	Ria	Sonar	Sera										
	46513	60201	54661	46513										

SHIPMENT DETAILS	TECHNICAL SPECIFICATIONS	RESISTANCE TEST
<b>Art.2400</b> 1 pz = 1  - kg 35/ m³ 1,18	<b>Art.2400</b> COL requirement m² 7.32 H 140 cm. COM Meterage m 4.07	<ul style="list-style-type: none"> <li>• EN 1728:2012 - EN 16139:2013 6.10</li> <li>• EN 1728:2012 - EN 16139:2013 6.17</li> <li>• EN 1728:2012 - EN 16139:2013 6.20</li> <li>• EN 1728:2012 - EN 16139:2013 6.25</li> <li>• EN 1728:2012 - EN 16139:2013 6.4</li> <li>• EN 1022:2018</li> <li>• ANSI/BIFMA X5.4-2020/5</li> <li>• ANSI/BIFMA X5.4-2020/9</li> <li>• ANSI/BIFMA X5.4-2020/13</li> <li>• ANSI/BIFMA X5.4-2020/15</li> <li>• ANSI/BIFMA X5.4-2020/19</li> <li>• ANSI/BIFMA X5.4-2020/21</li> </ul>
<b>FIRE RETARDANT TEST</b>		

Frame Base

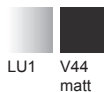

# Aston Club

Design by Jean-Marie Massaud, 2020

Footstool on a four-legged base in polished or powder-coated aluminium and a polyurethane shell covered with fabric, leather, coated fabric or a covering of the client's choice.

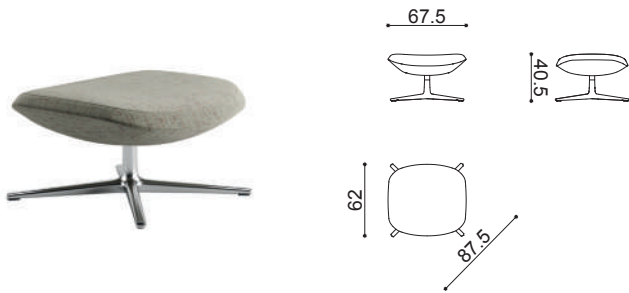

SEK ART. 2401	A	B COM	C COL	D	E	F	G	H	I	J	K	L	M	ES
	12883	13336	13789	14242	14695	15148	15601	16054	16507	16960	17413	17866	18319	20158
SPECIAL FABRICS	Fabthirty	Ria	Sonar	Sera										
	15601	20158	18319	15601										

SHIPMENT DETAILS	TECHNICAL SPECIFICATIONS	RESISTANCE TEST
<b>Art.2401</b> 1 pz = 1  - kg 15/ m² 0,3	<b>Art.2401</b> COL requirement m² 2.28 H 140 cm. COM Meterage m 1.3	<ul style="list-style-type: none"> <li>• EN 1728:2012 - EN 16139:2013 6.17</li> <li>• EN 1728:2012 - EN 16139:2013 6.24</li> <li>• EN 1728:2012 - EN 16139:2013 6.4</li> <li>• EN 1022:2018 7.2</li> </ul> <ul style="list-style-type: none"> <li>• EN 1728:2012 - EN 16139:2013 6.18</li> <li>• EN 1728:2012 - EN 16139:2013 6.25</li> <li>• EN 1728:2012 - EN 16139:2013 6.5</li> </ul>
FIRE RETARDANT TEST		

Frame Base





# Aston Club Low Back

Design by Jean-Marie Massaud, 2021

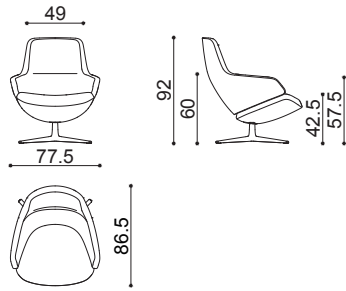

Lounge chair on a 4-ways base in polished or powder-coated aluminium with return mechanism. The shell – with a low backrest – is made of polyurethane upholstered with fabric, leather, coated fabric or customer's own material.

SEK ART. 2402	A	B COM	C COL	D	E	F	G	H	I	J	K	L	M	ES
	28779	29755	30731	31707	32683	33659	34635	35611	36587	37563	38539	39515	40491	44437
SPECIAL FABRICS	Fabthirty	Ria	Sonar	Sera										
	34635	44437	40491	34635										

SHIPMENT DETAILS	TECHNICAL SPECIFICATIONS	RESISTANCE TEST
<b>Art.2402</b> 1 pz = 1  - kg 45/ m³ 1,1	<b>Art.2402</b> COL requirement m² 6.78 H 140 cm. COM Meterage m 3.16	<ul style="list-style-type: none"> <li>• EN 1728:2012 - EN 16139:2013 6.10</li> <li>• EN 1728:2012 - EN 16139:2013 6.17</li> <li>• EN 1728:2012 - EN 16139:2013 6.20</li> <li>• EN 1728:2012 - EN 16139:2013 6.25</li> <li>• EN 1728:2012 - EN 16139:2013 6.4</li> <li>• EN 1022:2018</li> <li>• ANSI/BIFMA X5.4-2020/7</li> <li>• ANSI/BIFMA X5.4-2020/10</li> <li>• ANSI/BIFMA X5.4-2020/14</li> <li>• ANSI/BIFMA X5.4-2020/17</li> <li>• ANSI/BIFMA X5.4-2020/21</li> <li>• ANSI-BIFMA X5.4-2020/6</li> </ul>
<b>FIRE RETARDANT TEST</b>		

Frame Base

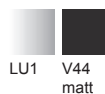

# CATIFA 46

---

Design by  
Lievore Altherr Molina  
2004

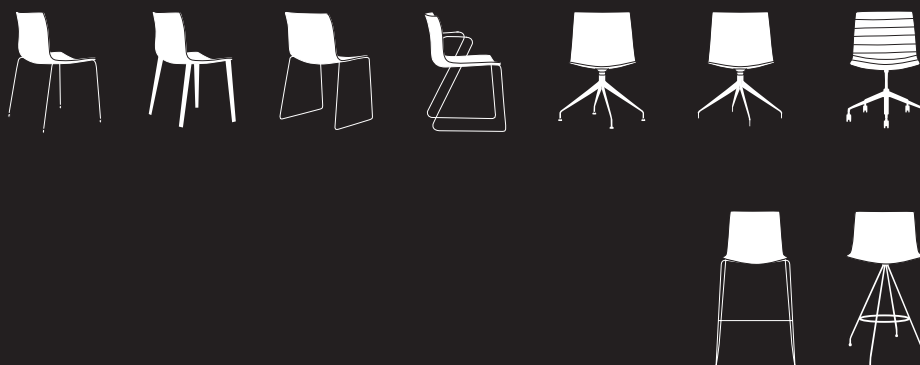

## Collection overview

### Bases



4 legs  
Armrest versions



4 wood legs



Sled  
Armrest versions



Technical sled



Aluminum trestle  
swivel base  
Armrest versions



Aluminum trestle  
fixed base  
Armrest versions



Alluminium 5 ways steel  
Armrest versions



Counter stool  
sled



Bar stool  
sled



Counter stool  
swivel base



Bar stool  
swivel base

# Catifa 46

## Shells

### Polypropylene



One color



Two colors



With cushion upholstered



With frontal upholstered

## Upholstery



Upholstered with a unremovable cover.



Upholstered with a removable cover. Available with 4 different stitchings



Upholstered in hard leather

## Wood



Wood shell with front upholstery

## Armrest types



BV =  
Brushed stainless structure,  
brass, steel

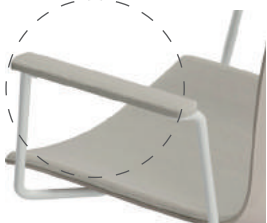

CV =  
Polypropylene pad



CI =  
Upholstered pad

For further accessories please go at the end of the collection



Outdoor options:  
available for polypropylene shells and  
the follow bases:  
— 4 legs  
— Sled

# Catifa 46

Design by Lievore Altherr Molina, 2004

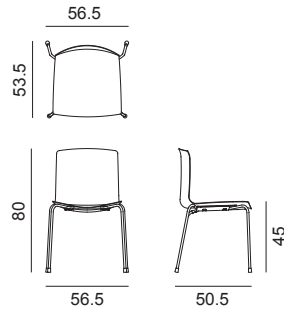

Chair with four-leg frame, available in chromed or powdercoated steel, or brushed stainless steel versions. The shell is available in single-colour polypropylene, bi-colour polypropylene or covered in hard leather without padding. Versions with polypropylene shell and powdercoated or brushed base can be used outdoor. Upon request armrests are offered in the same finishes of the base, also with pad.

**Accessories:**

- Link Art. 0258
- Stacking protection pad with link Art. 0260
- Cushion Art. 0261
- Stacking protection pad Art. 0262
- Removable cover Art. 0309
- Trolley Art. 0760
- Set of glides Art. 2015
- Movable link Art. 2073

**Stackability:**

(should the weight exceed 25 kilos a handling tool must be used).

- without tools up to 10 units
- with trolley up to 20 units
- with link: without tools up to 10 units
- with link: with trolley up to 14 units
- CT: with stacking pad, without tools up to 5 units
- CT: with stacking pad, with trolley up to 5 units
- CT with link: with stacking pad, without tools up to 5 units
- CT with link: with stacking pad, with trolley up to 5 units
- with arms (BV version only): without tools up to 5 units
- with arms (BV version only): with trolley up to 5 units
- with arms (BV version only) with link: without tools up to 5 units
- with arms (BV version only) with link: with trolley up to 5 units

<b>SEK ART. 0251</b>	<b>CT</b>	<b>PO bi-color</b>	<b>PO single-color</b>	
CHROMED / POWDERCOATED	5357	2214	1952	
BRUSHED STAINLESS STEEL	6537	3394	3132	
Armrests BV	+ 1083			
Armrests BV brushed stainless steel	+ 1607			
Armrests CV - pad (only for PO)	+ 334			
Hole on shell hole to allow water drainage (only for PO)	+ 143			
Outdoor powdercoated	+ 500			
Polypropylene fire retardant (only for PO)	+ 357			(For finishes: PO00101/109/112; for other colors qty min. 300 pcs)



# Catifa 46

Design by Lievore Altherr Molina, 2004

SHIPMENT DETAILS	TECHNICAL SPECIFICATIONS	RESISTANCE TEST
<b>Art.0251</b> 1 pz = 2  - kg 7,9/ m² 0,247 1 pz = 3  - kg 10,2/ m² 0,271 4 pz = 2  - kg 28/ m² 0,322 4 pz = 3  - kg 35,7/ m² 0,34 	<b>Art.0251</b> Outdoor: only for PO, V12, V13, V39, V48, V53, V54, V55, V56, V57 Outdoor powdercoated *Classe 1, 2, 1IM: fire retardant version available with surcharge and eventual minimum batch	<ul style="list-style-type: none"> <li>• EN 1728:2012 - EN 16139:2013 6.15</li> <li>• EN 1728:2012 - EN 16139:2013 6.4</li> <li>• EN 1728:2012 - EN 16139:2013 6.17</li> <li>• TUV GS (EN16139)</li> </ul> <ul style="list-style-type: none"> <li>• EN 1728:2012 - EN 16139:2013 6.16</li> <li>• EN 1728:2012 - EN 16139:2013 6.5</li> <li>• EN 1728:2012 - EN 16139:2013 6.18</li> </ul>

FIRE RETARDANT TEST
Classe 1 Omologazione Italia Polipropilene. • M2 Polipropilene.

## Frame Base



## Shell



Available also in one colour version (please check section "Finishes").

## Armrest



## Catifa 46

Design by Lievore Altherr Molina, 2004

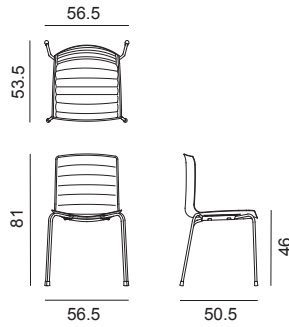

Chair with four-leg steel frame, available in chromed, brushed or powdercoated version. The shell is upholstered in leather, coated fabric, fabric or customer's own material. Line detail stitching. Upon request armrests are offered in the same finishes of the base.

### Accessories:

Link Art. 0258  
Stacking protection pad with link Art. 0277  
Stacking protection pad Art. 0499  
Trolley Art. 0760  
Set of glides Art. 2015  
Movable link Art. 2073

### Stackability:

(should the weight exceed 25 kilos a handling tool must be used).

- with stacking pad, without tools up to 8 units
- with stacking pad, with trolley up to 8 units
- with link: with stacking pad, without tools up to 8 units
- with link: with stacking pad, with trolley up to 8 units

- leather / coated fabric: with stacking pad, without tools up to 5 units
- leather / coated fabric: with stacking pad, with trolley up to 5 units
- leather / coated fabric with link: with stacking pad, without tools up to 5 units
- leather / coated fabric with link: with stacking pad, with trolley up to 5 units





- with arms (BV version only): with stacking pad, without tools up to 5 units
- with arms (BV version only): with stacking pad, with trolley up to 5 units
- with arms (BV version only) with link: with stacking pad, without tools up to 5 units
- with arms (BV version only) with link: with stacking pad, with trolley up to 5 units

<b>SEK ART. 0253</b>	<b>A</b>	<b>B COM</b>	<b>C COL</b>	<b>D</b>	<b>E</b>	<b>F</b>	<b>G</b>	<b>H</b>	<b>I</b>	<b>J</b>	<b>K</b>	<b>L</b>	<b>M</b>	<b>ES</b>
CHROMED / POWDERCOATED	4941	5251	5561	5871	6181	6491	6801	7111	7421	7731	8041	8351	8661	9810
BRUSHED STAINLESS STEEL	6121	6431	6741	7051	7361	7671	7981	8291	8601	8911	9221	9531	9841	10990
Armrests BV	+ 1083													
Armrests BV brushed stainless steel	+ 1607													
Armrests CI - only pad	+ 727													



# Catifa 46

Design by Lievore Altherr Molina, 2004

SHIPMENT DETAILS	TECHNICAL SPECIFICATIONS	RESISTANCE TEST
<b>Art.0253</b> 1 pz = 2  - kg 9,2/ m² 0,265 1 pz = 3  - kg 11,5/ m² 0,293 4 pz = 2  - kg 34/ m² 0,36 4 pz = 3  - kg 41,7/ m² 0,396 	<b>Art.0253</b> COL requirement m² 1.67 H 140 cm. COM Meterage m 1.1 *Classe 1, 2, 1IM: fire retardant version available with surcharge and eventual minimum batch	<ul style="list-style-type: none"> <li>• EN 1728:2012 - EN 16139:2013 6.15</li> <li>• EN 1728:2012 - EN 16139:2013 6.4</li> <li>• EN 1728:2012 - EN 16139:2013 6.17</li> <li>• TUV GS (EN16139)</li> </ul>

## FIRE RETARDANT TEST

Classe 1IM Omologazione Italia Divina MD Kvadrat. Divina Melange 3 Kvadrat. Divina 3 Kvadrat. Field Kvadrat. Coated fabric Valencia Spradling.  
 • FIRE RETARDANT VERSION WITH SURCHARGE \* Classe 1IM Omologazione Italia Elmosoft. Revive 1 Kvadrat. Steelcut Trio 3 Kvadrat.

## Frame Base



## Armrest





# Catifa 46

Design by Lievore Altherr Molina, 2013

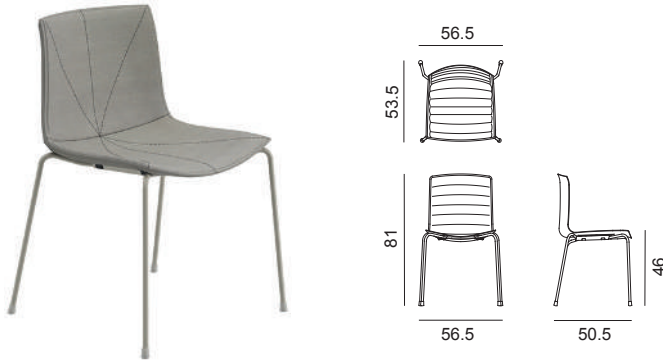

Chair with four-leg steel frame, available in chromed, brushed or powdercoated version. The white polypropylene shell (PO101) is upholstered with a removable non-washable cover in leather, coated fabric, fabric or customer's own material. The cover stitching comes in the same color as the upholstery. Stitching on cover 1 and 3 comes in white or black, to customer's choice. The chair is provided already fitted with the cover. Upon request armrests are offered in the same finishes of the base.

Accessories:  
 Link Art. 0258  
 Stacking protection pad with link Art. 0277  
 Stacking protection glide Art. 0286  
 Stacking protection pad Art. 0499  
 Trolley Art. 0760  
 Set of glides Art. 2015  
 Movable link Art. 2073

Stackability:  
 (should the weight exceed 25 kilos a handling tool must be used).





- with stacking pad, without tools up to 8 units
- with stacking pad, with trolley up to 8 units
- with link: with stacking pad, without tools up to 8 units
- with link: with stacking pad, with trolley up to 8 units
- leather / coated fabric: with stacking pad, without tools up to 5 units
- leather / coated fabric: with stacking pad, with trolley up to 5 units
- leather / coated fabric with link: with stacking pad, without tools up to 5 units
- leather / coated fabric with link: with stacking pad, with trolley up to 5 units
- with arms (BV version only): with stacking pad, without tools up to 2 units
- with arms (BV version only): with stacking pad, with trolley up to 5 units
- with arms (BV version only) with link: with stacking pad, without tools up to 5 units
- with arms (BV version only) with link: with stacking pad, with trolley up to 5 units

SEK ART. 0310	A	B COM	C COL	D	E	F	G	H	I	J	K	L	M	ES
CHROMED / POWDERCOATED - Cover 1	4881	5191	5501	5811	6121	6431	6741	7051	7361	7671	7981	8291	8601	9751
CHROMED / POWDERCOATED - Cover 2	5000	5310	5620	5930	6240	6550	6860	7170	7480	7790	8100	8410	8720	9883
CHROMED / POWDERCOATED - Cover 3	4881	5191	5501	5811	6121	6431	6741	7051	7361	7671	7981	8291	8601	9751
CHROMED / POWDERCOATED - Cover 4	4440	4750	5060	5370	5680	5990	6300	6610	6920	7230	7540	7850	8160	9334
STAINLESS STEEL - Cover 1	6061	6371	6681	6991	7301	7611	7921	8231	8541	8851	9161	9471	9781	10931
STAINLESS STEEL - Cover 2	6180	6490	6800	7110	7420	7730	8040	8350	8660	8970	9280	9590	9900	11063
STAINLESS STEEL - Cover 3	6061	6371	6681	6991	7301	7611	7921	8231	8541	8851	9161	9471	9781	10931
STAINLESS STEEL - Cover 4	5620	5930	6240	6550	6860	7170	7480	7790	8100	8410	8720	9030	9340	10514
Armrests BV	+ 1083													
Armrests BV brushed stainless steel	+ 1607													



# Catifa 46

Design by Lievore Altherr Molina, 2013

SHIPMENT DETAILS	TECHNICAL SPECIFICATIONS	RESISTANCE TEST
<b>Art.0310</b> 1 pz = 2  - kg 10,6/ m³ 0,272 1 pz = 3  - kg 12,9/ m³ 0,3 4 pz = 2  - kg 35,44/ m³ 0,368 4 pz = 3  - kg 43,12/ m³ 0,404 	<b>Art.0310</b> COL requirement m² 1.97 H 140 cm. COM Meterage m 1.08 *Classe 1, 2, 1IM: fire retardant version available with surcharge and eventual minimum batch	<ul style="list-style-type: none"> <li>• EN 1728:2012 - EN 16139:2013 6.15</li> <li>• EN 1728:2012 - EN 16139:2013 6.17</li> <li>• EN 1728:2012 - EN 16139:2013 6.4</li> <li>• TUV GS (EN16139)</li> </ul> <ul style="list-style-type: none"> <li>• EN 1728:2012 - EN 16139:2013 6.16</li> <li>• EN 1728:2012 - EN 16139:2013 6.18</li> <li>• EN 1728:2012 - EN 16139:2013 6.5</li> </ul>

FIRE RETARDANT TEST
Classe 1IM Omologazione Italia Divina MD Kvadrat. Divina Melange 3 Kvadrat. Divina 3 Kvadrat. Field Kvadrat. Coated fabric Valencia Spradling. • FIRE RETARDANT VERSION WITH SURCHARGE * Classe 1IM Omologazione Italia Elmosoft. Revive 1 Kvadrat. Steelcut Trio 3 Kvadrat.

## Frame Base



## Armrest

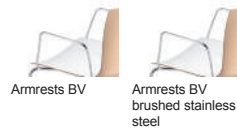

## Catifa 46

Design by Lievore Altherr Molina, 2004

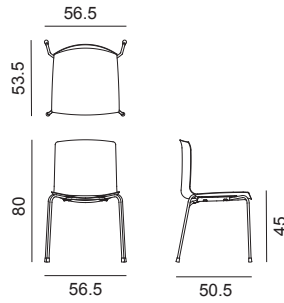

Chair with four-leg steel frame, available in chromed, brushed or powdercoated version. Oak-effect reconstituted veneer shell available in three finishes (natural oak, bleached oak, wengé). Upon request armrests are offered in the same finishes of the base.

Accessories:  
 Link Art. 0258  
 Cushion Art. 0261  
 Stacking protection glide Art. 0286  
 Trolley Art. 0760  
 Set of glides Art. 2015  
 Movable link Art. 2073

Stackability:  
 (should the weight exceed 25 kilos a handling tool must be used).





- with stacking pad, without tools up to 10 units
- with stacking pad, with trolley up to 10 units
- with link: with stacking pad, without tools up to 10 units
- with link: with stacking pad, with trolley up to 10 units
- with arms (BV version only): with stacking pad, without tools up to 5 units
- with arms (BV version only): with stacking pad, with trolley up to 5 units
- with arms (BV version only) with link: with stacking pad, without tools up to 5 units
- with arms (BV version only) with link: with stacking pad, with trolley up to 5 units

SEK ART. 0351	WOOD	
CHROMED / POWDERCOATED	5334	
BRUSHED STAINLESS STEEL	6514	
Armrests BV	+	1083
Armrests BV brushed stainless steel	+	1607



# Catifa 46

Design by Lievore Altherr Molina, 2004

SHIPMENT DETAILS	TECHNICAL SPECIFICATIONS	RESISTANCE TEST
<b>Art.0351</b> 1 pz = 2  - kg 7,38/ m³ 0,241 1 pz = 3  - kg 9,68/ m³ 0,269 4 pz = 2  - kg 25,9/ m³ 0,316 4 pz = 3  - kg 33,6/ m³ 0,352 	<b>Art.0351</b> *Classe 1, 2, 11M: fire retardant version available with surcharge and eventual minimum batch	<ul style="list-style-type: none"> <li>• EN 1728:2012 - EN 16139:2013 6.15</li> <li>• EN 1728:2012 - EN 16139:2013 6.18</li> <li>• EN 1728:2012 - EN 16139:2013 6.25</li> <li>• EN 1728:2012 - EN 16139:2013 6.5</li> </ul> <ul style="list-style-type: none"> <li>• EN 1728:2012 - EN 16139:2013 6.17</li> <li>• EN 1728:2012 - EN 16139:2013 6.24</li> <li>• EN 1728:2012 - EN 16139:2013 6.4</li> <li>• TUV GS (EN16139)</li> </ul>

FIRE RETARDANT TEST
• FIRE RETARDANT VERSION WITH SURCHARGE * Classe 1 Omologazione Italia Legno.

## Frame Base



## Shell

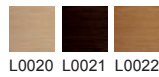

## Armrest



## Catifa 46

Design by Lievore Altherr Molina, 2004



Chair with four-leg steel frame, available in chromed, brushed or powdercoated version. Polypropylene shell with front upholstery in fabric, leather, coated fabric or customer's own material. Upon request armrests are offered in the same finishes of the base, also upholstered.

### Accessories:

Link Art. 0258  
Stacking protection pad with link Art. 0277  
Stacking protection pad Art. 0499  
Trolley Art. 0760  
Set of glides Art. 2015  
Movable link Art. 2073

### Stackability:

(should the weight exceed 25 kilos a handling tool must be used).





- with stacking pad, without tools up to 8 units
- with stacking pad, with trolley up to 8 units
- with link: with stacking pad, without tools up to 8 units
- with link: with stacking pad, with trolley up to 8 units
- leather / coated fabric: with stacking pad, without tools up to 5 units
- leather / coated fabric: with stacking pad, with trolley up to 5 units
- leather / coated fabric with link: with stacking pad, without tools up to 5 units
- leather / coated fabric with link: with stacking pad, with trolley up to 5 units
- with arms (BV version only): with stacking pad, without tools up to 5 units
- with arms (BV version only): with stacking pad, with trolley up to 5 units
- with arms (BV version only) with link: with stacking pad, without tools up to 5 units
- with arms (BV version only) with link: with stacking pad, with trolley up to 5 units

<b>SEK ART. 0458</b>	<b>A</b>	<b>B COM</b>	<b>C COL</b>	<b>D</b>	<b>E</b>	<b>F</b>	<b>G</b>	<b>H</b>	<b>I</b>	<b>J</b>	<b>K</b>	<b>L</b>	<b>M</b>	<b>ES</b>
CHROMED / POWDERCOATED	4822	4976	5130	5284	5438	5592	5746	5900	6054	6208	6362	6516	6670	8310
BRUSHED STAINLESS STEEL	6002	6156	6310	6464	6618	6772	6926	7080	7234	7388	7542	7696	7850	9490
Armrests BV	+ 1083													
Armrests BV brushed stainless steel	+ 1607													
Armrests CI - only pad	+ 727													



# Catifa 46

Design by Lievore Altherr Molina, 2004

SHIPMENT DETAILS	TECHNICAL SPECIFICATIONS	RESISTANCE TEST
<b>Art.0458</b> 1 pz = 2  - kg 10,6/ m³ 0,272 1 pz = 3  - kg 12,9/ m³ 0,3 4 pz = 2  - kg 35,44/ m³ 0,368 4 pz = 3  - kg 43,12/ m³ 0,404 	<b>Art.0458</b> COL requirement m² 0.94 H 140 cm. COM Meterage m 0.65	<ul style="list-style-type: none"> <li>• EN 1728:2012 - EN 16139:2013 6.15</li> <li>• EN 1728:2012 - EN 16139:2013 6.17</li> <li>• EN 1728:2012 - EN 16139:2013 6.4</li> <li>• TUV GS (EN16139)</li> </ul> <ul style="list-style-type: none"> <li>• EN 1728:2012 - EN 16139:2013 6.16</li> <li>• EN 1728:2012 - EN 16139:2013 6.18</li> <li>• EN 1728:2012 - EN 16139:2013 6.5</li> </ul>

## FIRE RETARDANT TEST

Classe 1IM Omologazione Italia Divina MD Kvadrat. Divina Melange 3 Kvadrat. Divina 3 Kvadrat. Elmosoft. Field Kvadrat. Hallingdal 65 Kvadrat. Revive 1 Kvadrat. Remix 3 Kvadrat. Coated fabric Valencia Spradling.

## Frame Base



## Shell



## Armrest



## Catifa 46

Design by Lievore Altherr Molina, 2014

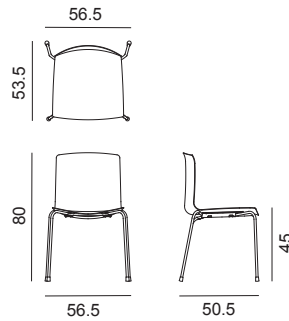

Chair with four-leg steel frame available in chromed steel, stainless steel or powdercoated version. Oak-effect reconstituted veneer shell available in three finishes (natural oak, bleached oak, wengé). Front upholstery in fabric or customer's own material. Upon request armrests are offered in the same finishes of the base, also with pad.

Accessories:  
 Link Art. 0258  
 Stacking protection pad with link Art. 0277  
 Stacking protection pad Art. 0499  
 Trolley Art. 0760  
 Set of glides Art. 2015  
 Movable link Art. 2073

Stackability:  
 (should the weight exceed 25 kilos a handling tool must be used).





- with stacking pad, without tools up to 8 units
- with stacking pad, with trolley up to 8 units
- with link: with stacking pad, without tools up to 8 units
- with link: with stacking pad, with trolley up to 8 units
- with arms (BV version only): with stacking pad, without tools up to 5 units
- with arms (BV version only): with stacking pad, with trolley up to 5 units
- with arms (BV version only) with link: with stacking pad, without tools up to 5 units
- with arms (BV version only) with link: with stacking pad, with trolley up to 5 units

SEK ART. 0325	A	B COM	C	D	E	F	G	H	I	J	K	L	M
CHROMED / POWDERCOATED	8263	8417	8571	8725	8879	9033	9187	9341	9495	9649	9803	9957	10111
BRUSHED STAINLESS STEEL	9443	9597	9751	9905	10059	10213	10367	10521	10675	10829	10983	11137	11291
Armrests BV	+ 1083												
Armrests BV brushed stainless steel	+ 1607												
Armrests CI - only pad	+ 727												



# Catifa 46

Design by Lievore Altherr Molina, 2014

SHIPMENT DETAILS	TECHNICAL SPECIFICATIONS	RESISTANCE TEST
<b>Art.0325</b> 1 pz = 2  - kg 10,6/ m³ 0,272 1 pz = 3  - kg 12,9/ m³ 0,3 4 pz = 2  - kg 35,44/ m³ 0,368 4 pz = 3  - kg 43,12/ m³ 0,404 	<b>Art.0325</b> H 140 cm. COM Meterage m 0.65	<ul style="list-style-type: none"> <li>TUV GS (EN16139)</li> </ul>

FIRE RETARDANT TEST
Classe 1IM Omologazione Italia Remix 3 Kvadrat.

## Frame Base



## Shell

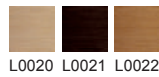

## Armrest





# Catifa 46

Design by Lievore Altherr Molina, 2012

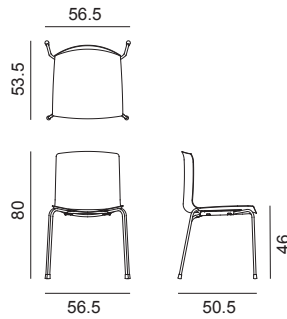

Chair with four-leg steel frame, available in chromed, brushed or powdercoated version. Polypropylene shell with cushion upholstered in fabric, leather, coated fabric or customer's own material applied to the seat surface. Upon request armrests are offered in the same finishes of the base, also upholstered.

**Accessories:**

- Link Art. 0258
- Stacking protection pad with link Art. 0277
- Stacking protection pad Art. 0499
- Trolley Art. 0760
- Set of glides Art. 2015
- Movable link Art. 2073

**Stackability:**

(should the weight exceed 25 kilos a handling tool must be used).





- with stacking pad, without tools up to 8 units
- with stacking pad, with trolley up to 8 units
- with link: with stacking pad, without tools up to 8 units
- with link: with stacking pad, with trolley up to 8 units
- leather / coated fabric: with stacking pad, without tools up to 5 units
- leather / coated fabric: with stacking pad, with trolley up to 5 units
- leather / coated fabric with link: with stacking pad, without tools up to 5 units
- leather / coated fabric with link: with stacking pad, with trolley up to 5 units
- with arms (BV version only): with stacking pad, without tools up to 5 units
- with arms (BV version only): with stacking pad, with trolley up to 5 units
- with arms (BV version only) with link: with stacking pad, without tools up to 5 units
- with arms (BV version only) with link: with stacking pad, with trolley up to 5 units

<b>SEK ART. 0450</b>	<b>A</b>	<b>B COM</b>	<b>C COL</b>	<b>D</b>	<b>E</b>	<b>F</b>	<b>G</b>	<b>H</b>	<b>I</b>	<b>J</b>	<b>K</b>	<b>L</b>	<b>M</b>	<b>ES</b>
CHROMED / POWDERCOATED PO two color	4179	4250	4321	4392	4463	4534	4605	4676	4747	4818	4889	4960	5031	5357
CHROMED / POWDERCOATED PO single color	3917	3988	4059	4130	4201	4272	4343	4414	4485	4556	4627	4698	4769	5083
BRUSHED STAINLESS STEEL PO two color	5359	5430	5501	5572	5643	5714	5785	5856	5927	5998	6069	6140	6211	6537
BRUSHED STAINLESS STEEL PO single color	5097	5168	5239	5310	5381	5452	5523	5594	5665	5736	5807	5878	5949	6263
Armrests BV	+ 1083													
Armrests BV brushed stainless steel	+ 1607													
Armrests CI - only pad	+ 727													



# Catifa 46

Design by Lievore Altherr Molina, 2012

SHIPMENT DETAILS	TECHNICAL SPECIFICATIONS	RESISTANCE TEST
<b>Art.0450</b> 1 pz = 2  - kg 10,6/ m³ 0,272 1 pz = 3  - kg 12,9/ m³ 0,3 4 pz = 2  - kg 35,44/ m³ 0,368 4 pz = 3  - kg 43,12/ m³ 0,404 	<b>Art.0450</b> COL requirement m² 0.48 H 140 cm. COM Meterage m 0.59	<ul style="list-style-type: none"> <li>• EN 1728:2012 - EN 16139:2013 6.15</li> <li>• EN 1728:2012 - EN 16139:2013 6.17</li> <li>• EN 1728:2012 - EN 16139:2013 6.4</li> <li>• TUV GS (EN16139)</li> </ul> <ul style="list-style-type: none"> <li>• EN 1728:2012 - EN 16139:2013 6.16</li> <li>• EN 1728:2012 - EN 16139:2013 6.18</li> <li>• EN 1728:2012 - EN 16139:2013 6.5</li> </ul>

FIRE RETARDANT TEST
Classe 1IM Omologazione Italia Divina MD Kvadrat. Divina Melange 3 Kvadrat. Divina 3 Kvadrat. Elmosoft. Field Kvadrat. Hallingdal 65 Kvadrat. Revive 1 Kvadrat. Remix 3 Kvadrat. Coated fabric Valencia Spradling.

## Frame Base



## Shell



Available also in one colour version (please check section "Finishes").

## Armrest





# Catifa 46

Design by Lievore Altherr Molina, 2012

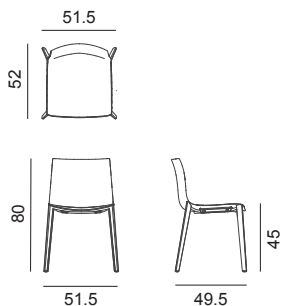

Chair with oak timber four-leg base (natural oak, bleached oak, wengè, teak colour) and single-colour, standard bi-colour (colourBi®) polypropylene shell. Alternatively, the shell is covered in hard leather without padding. Provided with glides suitable for various surfaces.

Accessories:  
Link Art. 0258  
Removable cover Art. 0309

<b>SEK ART. 0355</b>	CT	PO bi-color	PO single-color	
WOOD LEGS	7310	4167	3905	
Polypropylene fire retardant (only for PO)	+ 357 (For finishes: PO00101/109/112; for other colors qty min. 300 pcs)			

SHIPMENT DETAILS	TECHNICAL SPECIFICATIONS	RESISTANCE TEST
<b>Art.0355</b> 1 pz = 2  - kg 7,9/ m³ 0,247 4 pz = 2  - kg 28/ m³ 0,322 	<b>Art.0355</b> *Classe 1, 2, 11M: fire retardant version available with surcharge and eventual minimum batch	<ul style="list-style-type: none"> <li>• EN 1728:2012 - EN 16139:2013 6.15</li> <li>• EN 1728:2012 - EN 16139:2013 6.17</li> <li>• EN 1728:2012 - EN 16139:2013 6.24</li> <li>• EN 1728:2012 - EN 16139:2013 6.4</li> <li>• TUV GS (EN16139)</li> </ul>

- EN 1728:2012 - EN 16139:2013 6.16
- EN 1728:2012 - EN 16139:2013 6.18
- EN 1728:2012 - EN 16139:2013 6.25
- EN 1728:2012 - EN 16139:2013 6.5
- EN 1728:2012 - EN 16139:2013 6.6

### FIRE RETARDANT TEST

Classe 1 Omologazione Italia Polipropilene. • Classe 11M Omologazione Italia Elmosoft. • M2 Polipropilene.

### Frame Base

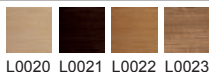

### Shell



Available also in one colour version (please check section "Finishes" ).



# Catifa 46

Design by Lievore Altherr Molina, 2012

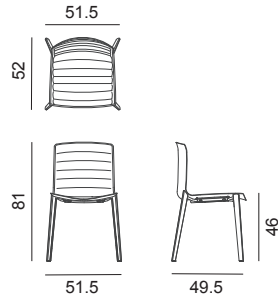

Chair with oak timber four-leg base (natural oak, bleached oak, wengé, teak colour) and shell upholstered in leather, coated fabric, fabric or customer's own material. Line detail stitching. Provided with glides suitable for various surfaces.

Accessories:  
Link Art. 0258

SEK ART. 0356	A	B COM	C COL	D	E	F	G	H	I	J	K	L	M	ES
WOOD LEGS	6894	7204	7514	7824	8134	8444	8754	9064	9374	9684	9994	10304	10614	11763

SHIPMENT DETAILS	TECHNICAL SPECIFICATIONS	RESISTANCE TEST
<b>Art.0356</b> 1 pz = 2  - kg 9,2/ m³ 0,271 4 pz = 2  - kg 34/ m³ 0,373 	<b>Art.0356</b> COL requirement m² 1.67 H 140 cm. COM Meterage m 1.1 *Classe 1, 2, 11M: fire retardant version available with surcharge and eventual minimum batch	<ul style="list-style-type: none"> <li>TUV GS (EN16139)</li> </ul>
<b>FIRE RETARDANT TEST</b> Classe 11M Omologazione Italia Divina MD Kvadrat. Divina Melange 3 Kvadrat. Divina 3 Kvadrat. Field Kvadrat. Coated fabric Valencia Spradling. • FIRE RETARDANT VERSION WITH SURCHARGE * Classe 11M Omologazione Italia Elmosoft. Revive 1 Kvadrat. Steelcut Trio 3 Kvadrat.		

Frame Base



# Catifa 46

Design by Lievore Altherr Molina, 2013

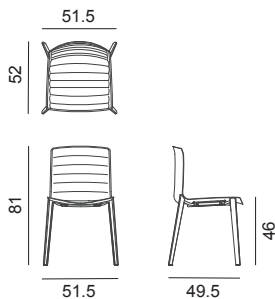

Chair with oak timber four-leg base (natural oak, bleached oak, wengé, teak colour) and polypropylene shell upholstered with a removable non-washable cover in leather, coated fabric, fabric or customer's own material. The cover stitching comes in the same color as the upholstery. Stitching on cover 1 and 3 comes in white or black, to customer's choice. The chair is provided already fitted with the cover.

Accessories:  
Link Art. 0258

SEK ART. 0311	A	B COM	C COL	D	E	F	G	H	I	J	K	L	M	ES
WOOD LEGS - Cover 1	6834	7144	7454	7764	8074	8384	8694	9004	9314	9624	9934	10244	10554	11704
WOOD LEGS - Cover 2	6953	7263	7573	7883	8193	8503	8813	9123	9433	9743	10053	10363	10673	11836
WOOD LEGS - Cover 3	6834	7144	7454	7764	8074	8384	8694	9004	9314	9624	9934	10244	10554	11704
WOOD LEGS - Cover 4	6393	6703	7013	7323	7633	7943	8253	8563	8873	9183	9493	9803	10113	11287

SHIPMENT DETAILS	TECHNICAL SPECIFICATIONS	RESISTANCE TEST
<b>Art.0311</b> 1 pz = 2  - kg 9,2/ m² 0,271 4 pz = 2  - kg 34/ m² 0,373 	<b>Art.0311</b> COL requirement m² 1.97 H 140 cm. COM Meterage m 1.08 *Classe 1, 2, 1IM: fire retardant version available with surcharge and eventual minimum batch	<ul style="list-style-type: none"> <li>TUV GS (EN16139)</li> </ul>
<b>FIRE RETARDANT TEST</b> Classe 1IM Omologazione Italia Divina MD Kvadrat. Divina Melange 3 Kvadrat. Divina 3 Kvadrat. Field Kvadrat. Coated fabric Valencia Spradling. * FIRE RETARDANT VERSION WITH SURCHARGE * Classe 1IM Omologazione Italia Elmosoft. Revive 1 Kvadrat. Steelcut Trio 3 Kvadrat.		

## Frame Base

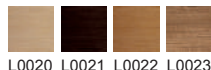

# Catifa 46

Design by Lievore Altherr Molina, 2012

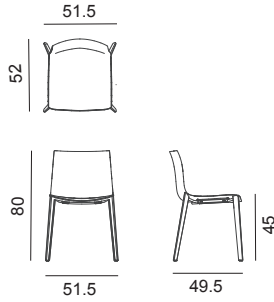

Chair with oak timber four-leg base (natural oak, bleached oak, wengé) and oak-effect reconstituted veneer shell available in three finishes (natural oak, bleached oak, wengé). Provided with glides suitable for different surfaces.

Accessories:  
Link Art. 0258  
Cushion Art. 0261

<b>SEK ART. 0359</b>	WOOD	
WOOD LEGS	7287	
<b>SHIPMENT DETAILS</b>	<b>TECHNICAL SPECIFICATIONS</b>	<b>RESISTANCE TEST</b>
<b>Art.0359</b> 1 pz = 2  - kg 7,1/ m³ 0,247 4 pz = 2  - kg 24,82/ m³ 0,329 	<b>Art.0359</b> *Classe 1, 2, 11M: fire retardant version available with surcharge and eventual minimum batch	<ul style="list-style-type: none"> <li>TUV GS (EN16139)</li> </ul>
<b>FIRE RETARDANT TEST</b>		
* FIRE RETARDANT VERSION WITH SURCHARGE * Classe 1 Omologazione Italia Legno.		

## Frame Base

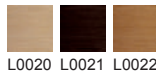

L0020 L0021 L0022



## Shell

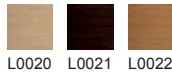

L0020 L0021 L0022



# Catifa 46

Design by Lievore Altherr Molina, 2012

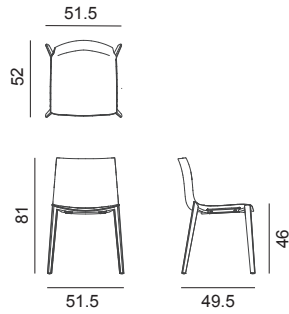

Chair with oak timber four-leg base (natural oak, bleached oak, wengé, teak colour) and polypropylene shell with front upholstery in fabric, leather, coated fabric or customer's own material. Provided with glides suitable for various surfaces.

Accessories:  
Link Art. 0258

SEK ART. 0358	A	B COM	C COL	D	E	F	G	H	I	J	K	L	M	ES
WOOD LEGS	6775	6929	7083	7237	7391	7545	7699	7853	8007	8161	8315	8469	8623	10263
<b>SHIPMENT DETAILS</b>	<b>TECHNICAL SPECIFICATIONS</b>				<b>RESISTANCE TEST</b>									
<b>Art.0358</b> 1 pz = 2  - kg 10,6/ m³ 0,285 4 pz = 2  - kg 35,44/ m³ 0,374 	<b>Art.0358</b> COL requirement m² 0.94 H 140 cm. COM Meterage m 0.65				• TUV GS (EN16139)									
<b>FIRE RETARDANT TEST</b>														
Classe 1IM Omologazione Italia Divina MD Kvadrat. Divina Melange 3 Kvadrat. Divina 3 Kvadrat. Elmosoft. Field Kvadrat. Hallingdal 65 Kvadrat. Remix 3 Kvadrat. Coated fabric Valencia Spradling.														

## Frame Base

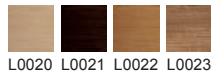

## Shell





# Catifa 46

Design by Lievore Altherr Molina, 2012

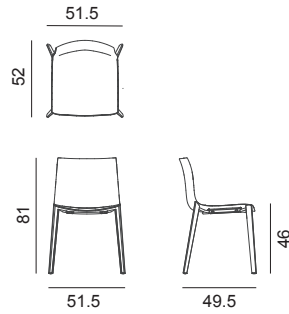

Chair with oak timber four-leg base (natural oak, bleached oak, wengé) and oak-effect reconstituted veneer shell available in three finishes (natural oak, bleached oak, wengé). Front upholstery in fabric or customer's own material. Provided with glides suitable for different surfaces.

Accessories:  
Link Art. 0258

SEK ART. 0329	A	B COM	C	D	E	F	G	H	I	J	K	L	M
WOOD LEGS	10216	10370	10524	10678	10832	10986	11140	11294	11448	11602	11756	11910	12064
<b>SHIPMENT DETAILS</b>	<b>TECHNICAL SPECIFICATIONS</b>				<b>RESISTANCE TEST</b>								
<b>Art.0329</b> 1 pz = 2  - kg 10,6/ m³ 0,285 4 pz = 2  - kg 35,44/ m³ 0,374 	<b>Art.0329</b> H 140 cm. COM Meterage m 0,65				<ul style="list-style-type: none"> <li>TUV GS (EN16139)</li> </ul>								
<b>FIRE RETARDANT TEST</b>													
Classe 1IM Omologazione Italia Remix 3 Kvadrat.													

Frame Base

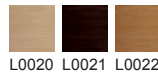

L0020 L0021 L0022



Shell

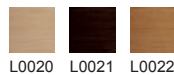

L0020 L0021 L0022



# Catifa 46

Design by Lievore Altherr Molina, 2012

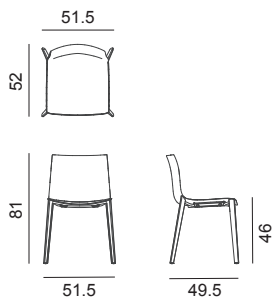

Chair with oak timber four-leg base (natural oak, bleached oak, wengé, teak colour) and polypropylene shell with cushion upholstered in fabric, leather, coated fabric or customer's own material applied to the seat surface. Provided with glides suitable for various surfaces.

Accessories:  
Link Art. 0258

SEK ART. 0308	A	B COM	C COL	D	E	F	G	H	I	J	K	L	M	ES
WOOD LEGS PO two color	6132	6203	6274	6345	6416	6487	6558	6629	6700	6771	6842	6913	6984	7310
WOOD LEGS PO single color	5870	5941	6012	6083	6154	6225	6296	6367	6438	6509	6580	6651	6722	7036

SHIPMENT DETAILS	TECHNICAL SPECIFICATIONS	RESISTANCE TEST
<b>Art.0308</b> 1 pz = 2  - kg 10,6/ m³ 0,285 4 pz = 2  - kg 35,44/ m³ 0,374 	<b>Art.0308</b> COL requirement m² 0.48 H 140 cm. COM Meterage m 0.59	<ul style="list-style-type: none"> <li>TUV GS (EN16139)</li> </ul>
<b>FIRE RETARDANT TEST</b> Classe 1IM Omologazione Italia Divina MD Kvadrat. Divina Melange 3 Kvadrat. Divina 3 Kvadrat. Elmosoft. Field Kvadrat. Revive 1 Kvadrat. Remix 3 Kvadrat. Coated fabric Valencia Spradling.		

## Frame Base



L0020 L0021 L0022 L0023



## Shell



PO00204 PO00205 PO00209 PO00212 PO00213 PO00214 PO00215 PO00216 PO00217 PO00218

Available also in one colour version (please check section "Finishes").



# Catifa 46

Design by Lievore Altherr Molina, 2004

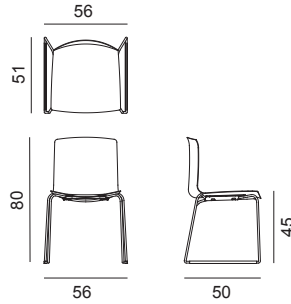

Chair with chromed or powdercoated steel sled base and shell in single colour polypropylene, bi-colour polypropylene or covered in hard leather without padding. Optional glides with felt for wooden floors are available upon request. Steel armrests, also with pad, are available upon request.

Accessories:  
 Link Art. 0258  
 Cushion Art. 0261  
 Stacking protection pad Art. 0262  
 Stacking protection glide Art. 0286  
 Removable cover Art. 0309  
 Trolley Art. 0760

### Stackability:

(should the weight exceed 25 kilos a handling tool must be used).

- without tools up to 10 units
- with trolley up to 20 units

- CT: with stacking pad, without tools up to 5 units
- CT: with stacking pad, with trolley up to 5 units
- CT with link: with stacking pad, without tools up to 5 units
- CT with link: with stacking pad, with trolley up to 5 units

- with arms: without tools non stackable.
- with arms: with trolley non stackable.
- with arms with link: without tools non stackable.
- with arms with link: with trolley non stackable.

SEK ART. 0278	CT	PO bi-color	PO single-color
CHROMED / POWDERCOATED	5703	2560	2298
Armrests BV	+ 1083		
Armrests CV - pad (only for PO)	+ 334		
Hole on shell hole to allow water drainage (only for PO)	+ 143		
Outdoor powdercoated	+ 500		
Polypropylene fire retardant (only for PO)	+ 357 (For finishes: PO00101/109/112; for other colors qty min. 300 pcs)		

SHIPMENT DETAILS	TECHNICAL SPECIFICATIONS	RESISTANCE TEST
<b>Art.0278</b> 1 pz = 2  - kg 10,4/ m³ 0,243 1 pz = 3  - kg 12,7/ m³ 0,273 4 pz = 2  - kg 32/ m³ 0,304 4 pz = 3  - kg 39,7/ m³ 0,34 KD	<b>Art.0278</b> Outdoor: only for PO, V12, V13, V39, V48, V53, V54, V55, V56, V57 Outdoor powdercoated *Classe 1, 2, 11M: fire retardant version available with surcharge and eventual minimum batch	<ul style="list-style-type: none"> <li>• EN 1728:2012 - EN 16139:2013 6.15</li> <li>• EN 1728:2012 - EN 16139:2013 6.17</li> <li>• EN 1728:2012 - EN 16139:2013 6.24</li> <li>• EN 1728:2012 - EN 16139:2013 6.4</li> <li>• TUV GS (EN16139)</li> <li>• EN 1728:2012 - EN 16139:2013 6.16</li> <li>• EN 1728:2012 - EN 16139:2013 6.18</li> <li>• EN 1728:2012 - EN 16139:2013 6.25</li> <li>• EN 1728:2012 - EN 16139:2013 6.5</li> </ul>
<b>FIRE RETARDANT TEST</b> Classe 1 Omologazione Italia Polipropilene. • M2 Polipropilene.		

### Frame Base



### Shell



Available also in one colour version (please check section "Finishes").

### Armrest



# Catifa 46

Design by Lievore Altherr Molina, 2004

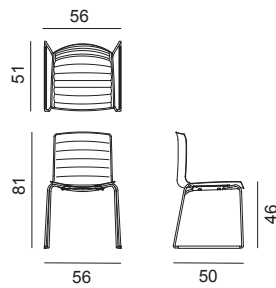

Chair with chromed or powdercoated steel sled base and shell upholstered in leather, coated fabric, fabric or customer's own material. Line detail stitching. Optional glides with felt for wooden floors are available upon request. Steel armrests, also upholstered, are available upon request.

#### Accessories:

Link Art. 0258  
Stacking protection pad with link Art. 0277  
Stacking protection pad Art. 0499  
Trolley Art. 0760

#### Stackability:

(should the weight exceed 25 kilos a handling tool must be used).

- with stacking pad, without tools up to 8 units
- with stacking pad, with trolley up to 8 units
- with link: with stacking pad, without tools up to 8 units
- with link: with stacking pad, with trolley up to 8 units
- leather / coated fabric: with stacking pad, without tools up to 5 units
- leather / coated fabric: with stacking pad, with trolley up to 5 units
- leather / coated fabric with link: with stacking pad, without tools up to 5 units
- leather / coated fabric with link: with stacking pad, with trolley up to 5 units
- with arms: with stacking pad, without tools non stackable.
- with arms: with stacking pad, with trolley non stackable.
- with arms with link: with stacking pad, without tools non stackable.
- with arms with link: with stacking pad, with trolley non stackable.

SEK ART. 0280	A	B COM	C COL	D	E	F	G	H	I	J	K	L	M	ES
CHROMED / POWDERCOATED	5287	5597	5907	6217	6527	6837	7147	7457	7767	8077	8387	8697	9007	10156
Armrests BV	+ 1083													
Armrests CI - only pad	+ 727													

SHIPMENT DETAILS	TECHNICAL SPECIFICATIONS	RESISTANCE TEST
<b>Art.0280</b> 1 pz = 2  - kg 11,7/ m³ 0,267 1 pz = 3  - kg 14/ m³ 0,295 4 pz = 2  - kg 38/ m³ 0,36 4 pz = 3  - kg 45,7/ m³ 0,396 KD	<b>Art.0280</b> COL requirement m² 1.67 H 140 cm. COM Meterage m 1.1 *Classe 1, 2, 11M: fire retardant version available with surcharge and eventual minimum batch	• TUV GS (EN16139)
<b>FIRE RETARDANT TEST</b> Classe 11M Omologazione Italia Divina MD Kvadrat. Divina Melange 3 Kvadrat. Divina 3 Kvadrat. Field Kvadrat. Coated fabric Valencia Spradling. • FIRE RETARDANT VERSION WITH SURCHARGE * Classe 11M Omologazione Italia Elmosoft. Steelcut Trio 3 Kvadrat.		

#### Frame Base



#### Armrest



Stackable



Standard: polycarbonate glide with polyurethane insert.



Upon request: polycarbonate glide with felt insert.



## Catifa 46

Design by Lievore Altherr Molina, 2013

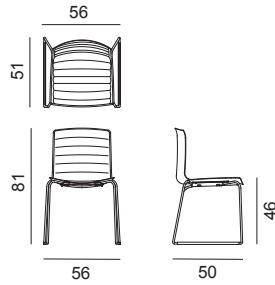

Chair with chromed or powdercoated steel sled base and white polypropylene shell (PO101) upholstered with a removable non-washable cover in leather, coated fabric, fabric or customer's own material. The cover stitching comes in the same color as the upholstery. Stitching on cover 1 and 3 comes in white or black, to customer's choice. The chair is provided already fitted with the cover. Optional glides with felt for wooden floors are available upon request. Steel armrests are available upon request.

### Accessories:

Link Art. 0258  
Stacking protection pad with link Art. 0277  
Stacking protection glide Art. 0286  
Stacking protection pad Art. 0499  
Trolley Art. 0760

### Stackability:

(should the weight exceed 25 kilos a handling tool must be used).





- with stacking pad, without tools up to 8 units
- with stacking pad, with trolley up to 8 units
- with link: with stacking pad, without tools up to 8 units
- with link: with stacking pad, with trolley up to 8 units
- leather / coated fabric: with stacking pad, without tools up to 5 units
- leather / coated fabric: with stacking pad, with trolley up to 5 units
- leather / coated fabric with link: with stacking pad, without tools up to 5 units
- leather / coated fabric with link: with stacking pad, with trolley up to 5 units
- with arms: with stacking pad, without tools non stackable.
- with arms: with stacking pad, with trolley non stackable.
- with arms with link: with stacking pad, without tools non stackable.
- with arms with link: with stacking pad, with trolley non stackable.

SEK ART. 0312	A	B COM	C COL	D	E	F	G	H	I	J	K	L	M	ES
CHROMED / POWDERCOATED - Cover 1	5227	5537	5847	6157	6467	6777	7087	7397	7707	8017	8327	8637	8947	10097
CHROMED / POWDERCOATED - Cover 2	5346	5656	5966	6276	6586	6896	7206	7516	7826	8136	8446	8756	9066	10229
CHROMED / POWDERCOATED - Cover 3	5227	5537	5847	6157	6467	6777	7087	7397	7707	8017	8327	8637	8947	10097
CHROMED / POWDERCOATED - Cover 4	4786	5096	5406	5716	6026	6336	6646	6956	7266	7576	7886	8196	8506	9680
Armrests BV	+ 1083													



# Catifa 46

Design by Lievore Altherr Molina, 2013

SHIPMENT DETAILS	TECHNICAL SPECIFICATIONS	RESISTANCE TEST
<b>Art.0312</b> 1 pz = 2  - kg 11,7/ m³ 0,267 1 pz = 3  - kg 14/ m³ 0,295 4 pz = 2  - kg 38/ m³ 0,36 4 pz = 3  - kg 45,7/ m³ 0,396 	<b>Art.0312</b> COL requirement m² 1.97 H 140 cm. COM Meterage m 1.08 *Classe 1, 2, 1IM: fire retardant version available with surcharge and eventual minimum batch	<ul style="list-style-type: none"> <li>TUV GS (EN16139)</li> </ul>

## FIRE RETARDANT TEST

Classe 1IM Omologazione Italia Divina MD Kvadrat. Divina Melange 3 Kvadrat. Divina 3 Kvadrat. Field Kvadrat. Coated fabric Valencia Spradling.  
 • FIRE RETARDANT VERSION WITH SURCHARGE \* Classe 1IM Omologazione Italia Elmosoft. Revive 1 Kvadrat. Steelcut Trio 3 Kvadrat.

## Frame Base

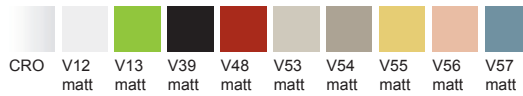

## Armrest



Cover 1



Cover 2



Cover 3



Cover 4



Stackable



Standard: polycarbonate glide with polyurethane insert.



Upon request: polycarbonate glide with felt insert.

# Catifa 46

Design by Lievore Altherr Molina, 2004

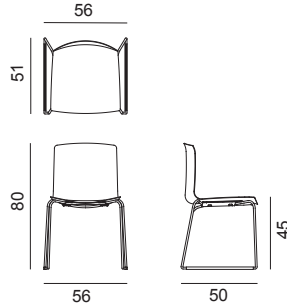

Chair with chromed or powder-coated steel sled base and oak-effect reconstituted veneer shell available in three finishes (natural oak, bleached oak, wengé). Glides for wooden floors available upon request. Steel armrests are available upon request.

Accessories:  
 Link Art. 0258  
 Cushion Art. 0261  
 Stacking protection glide Art. 0286  
 Trolley Art. 0760

**Stackability:**

(should the weight exceed 25 kilos a handling tool must be used).

- with stacking pad, without tools up to 10 units
- with stacking pad, with trolley up to 10 units

- with arms: with stacking pad, without tools non stackable.
- with arms: with stacking pad, with trolley non stackable.
- with arms with link: with stacking pad, without tools non stackable.
- with arms with link: with stacking pad, with trolley non stackable.

<b>SEK ART. 0378</b>	<b>WOOD</b>	
CHROMED / POWDERCOATED	5680	
Armrests BV	+ 1083	
<b>SHIPMENT DETAILS</b>	<b>TECHNICAL SPECIFICATIONS</b>	<b>RESISTANCE TEST</b>
<b>Art.0378</b> 1 pz = 2  - kg 9,88/ m³ 0,243 1 pz = 3  - kg 12,18/ m³ 0,271 4 pz = 2  - kg 29,9/ m³ 0,316 4 pz = 3  - kg 37,6/ m³ 0,352 	<b>Art.0378</b> *Classe 1, 2, 11M: fire retardant version available with surcharge and eventual minimum batch	<ul style="list-style-type: none"> <li>• EN 1728:2012 - EN 16139:2013 6.15</li> <li>• EN 1728:2012 - EN 16139:2013 6.17</li> <li>• EN 1728:2012 - EN 16139:2013 6.24</li> <li>• EN 1728:2012 - EN 16139:2013 4.1-4.2</li> <li>• EN 1728:2012 - EN 12520:2015 5.4.2</li> <li>• TUV GS (EN16139)</li> </ul> <ul style="list-style-type: none"> <li>• EN 1728:2012 - EN 16139:2013 6.16</li> <li>• EN 1728:2012 - EN 16139:2013 6.18</li> <li>• EN 1728:2012 - EN 16139:2013 6.25</li> <li>• EN 1728:2012 - EN 16139:2013 6.4</li> <li>• EN 1728:2012 - EN 16139:2013 6.5</li> </ul>
<b>FIRE RETARDANT TEST</b>		
* FIRE RETARDANT VERSION WITH SURCHARGE * Classe 1 Omologazione Italia Legno.		

**Frame Base**



**Shell**

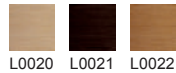

**Armrest**



Stackable



Standard: polycarbonate glide with polyurethane insert.



Upon request: polycarbonate glide with felt insert.



# Catifa 46

Design by Lievore Altherr Molina, 2004

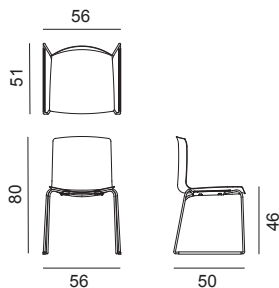

Chair with chromed or powder-coated steel sled base and polypropylene shell with front upholstery in fabric, leather, coated fabric or customer's own material. Optional glides with felt for wooden floors are available upon request. Steel armrests, also upholstered, are available upon request.

#### Accessories:

- Link Art. 0258
- Stacking protection pad with link Art. 0277
- Stacking protection pad Art. 0499
- Trolley Art. 0760

#### Stackability:

(should the weight exceed 25 kilos a handling tool must be used).

- with stacking pad, without tools up to 8 units
- with stacking pad, with trolley up to 8 units
- with link: with stacking pad, without tools up to 8 units
- with link: with stacking pad, with trolley up to 8 units
- leather / coated fabric: with stacking pad, without tools up to 5 units
- leather / coated fabric: with stacking pad, with trolley up to 5 units
- leather / coated fabric with link: with stacking pad, without tools up to 5 units
- leather / coated fabric with link: with stacking pad, with trolley up to 5 units
- with arms: with stacking pad, without tools non stackable.
- with arms: with stacking pad, with trolley non stackable.
- with arms with link: with stacking pad, without tools non stackable.
- with arms with link: with stacking pad, with trolley non stackable.

SEK ART. 0468	A	B COM	C COL	D	E	F	G	H	I	J	K	L	M	ES
CHROMED / POWDERCOATED	5168	5322	5476	5630	5784	5938	6092	6246	6400	6554	6708	6862	7016	8656
Armrests BV	+ 1083													
Armrests CI - only pad	+ 727													

SHIPMENT DETAILS	TECHNICAL SPECIFICATIONS	RESISTANCE TEST
<b>Art.0468</b> 1 pz = 2  - kg 13,1/ m³ 0,274 1 pz = 3  - kg 15,4/ m³ 0,302 4 pz = 2  - kg 39,44/ m³ 0,368 4 pz = 3  - kg 47,12/ m³ 0,404 	<b>Art.0468</b> COL requirement m² 0.94 H 140 cm. COM Meterage m 0.65	• TUV GS (EN16139)

#### FIRE RETARDANT TEST

Classe 11M Omologazione Italia Divina MD Kvadrat. Divina Melange 3 Kvadrat. Divina 3 Kvadrat. Elmosoft. Field Kvadrat. Hallingdal 65 Kvadrat. Revive 1 Kvadrat. Remix 3 Kvadrat. Coated fabric Valencia Spradling.

#### Frame Base



#### Shell



#### Armrest





# Catifa 46

Design by Lievore Altherr Molina, 2014

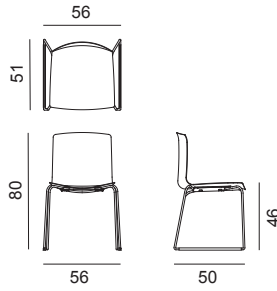

Chair with chromed or powder-coated steel sled base and oak-effect reconstituted veneer shell available in three finishes (natural oak, bleached oak, wengé). Front upholstery in fabric or customer's own material. Glides for wooden floors available upon request without surcharge. Steel armrests, also upholstered, are available upon request.

Accessories:  
 Link Art. 0258  
 Stacking protection pad with link Art. 0277  
 Stacking protection pad Art. 0499  
 Trolley Art. 0760

### Stackability:

(should the weight exceed 25 kilos a handling tool must be used).

- with stacking pad, without tools up to 8 units
- with stacking pad, with trolley up to 8 units
- with link: with stacking pad, without tools up to 8 units
- with link: with stacking pad, with trolley up to 8 units
- with arms: with stacking pad, without tools non stackable.
- with arms: with stacking pad, with trolley non stackable.
- with arms with link: with stacking pad, without tools non stackable.
- with arms with link: with stacking pad, with trolley non stackable.

SEK ART. 0326	A	B COM	C	D	E	F	G	H	I	J	K	L	M
CHROMED / POWDERCOATED	8609	8763	8917	9071	9225	9379	9533	9687	9841	9995	10149	10303	10457
Armrests BV	+ 1083												
Armrests CI - only pad	+ 727												
<b>SHIPMENT DETAILS</b>	<b>TECHNICAL SPECIFICATIONS</b>				<b>RESISTANCE TEST</b>								
<b>Art.0326</b> 1 pz = 2  - kg 13,1/ m³ 0,274 1 pz = 3  - kg 15,4/ m³ 0,302 4 pz = 2  - kg 39,44/ m³ 0,368 4 pz = 3  - kg 47,12/ m³ 0,404 (KD)	<b>Art.0326</b> H 140 cm. COM Meterage m 0,65				• TUV GS (EN16139)								
<b>FIRE RETARDANT TEST</b>													
Classe 1IM Omologazione Italia Remix 3 Kvadrat.													

### Frame Base

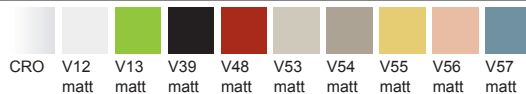

### Shell

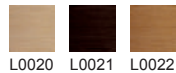

### Armrest



Stackable



Standard: polycarbonate glide with polyurethane insert.



Upon request: polycarbonate glide with felt insert.



# Catifa 46

Design by Lievore Altherr Molina, 2012

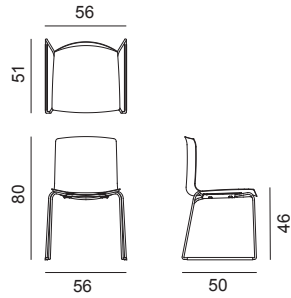

Chair with chromed or powder-coated steel sled base and polypropylene shell with cushion upholstered in fabric, leather, coated fabric or customer's own material applied to the seat surface. Optional glides with felt for wooden floors are available upon request. Steel armrests, also upholstered, are available upon request.

Accessories:  
 Link Art. 0258  
 Stacking protection pad with link Art. 0277  
 Stacking protection pad Art. 0499  
 Trolley Art. 0760

### Stackability:

(should the weight exceed 25 kilos a handling tool must be used).

- with stacking pad, without tools up to 8 units
- with stacking pad, with trolley up to 8 units
- with link: with stacking pad, without tools up to 8 units
- with link: with stacking pad, with trolley up to 8 units
- leather / coated fabric: with stacking pad, without tools up to 5 units
- leather / coated fabric: with stacking pad, with trolley up to 5 units
- leather / coated fabric with link: with stacking pad, without tools up to 5 units
- leather / coated fabric with link: with stacking pad, with trolley up to 5 units
- with arms: with stacking pad, without tools non stackable.
- with arms: with stacking pad, with trolley non stackable.
- with arms with link: with stacking pad, without tools non stackable.
- with arms with link: with stacking pad, with trolley non stackable.

SEK ART. 0452	A	B COM	C COL	D	E	F	G	H	I	J	K	L	M	ES
PO Bicolors	4525	4596	4667	4738	4809	4880	4951	5022	5093	5164	5235	5306	5377	5703
PO single-color	4263	4334	4405	4476	4547	4618	4689	4760	4831	4902	4973	5044	5115	5429
Armrests BV	+ 1083													
Armrests CI - only pad	+ 727													

SHIPMENT DETAILS	TECHNICAL SPECIFICATIONS	RESISTANCE TEST
<b>Art.0452</b> 1 pz = 2  - kg 13,1/ m³ 0,274 1 pz = 3  - kg 15,4/ m³ 0,302 4 pz = 2  - kg 39,44/ m³ 0,368 4 pz = 3  - kg 47,12/ m³ 0,404 KD	<b>Art.0452</b> COL requirement m² 0.48 H 140 cm. COM Meterage m 0.59	• TUV GS (EN16139)

**FIRE RETARDANT TEST**  
 Classe 11M Omologazione Italia Divina MD Kvadrat. Divina Melange 3 Kvadrat. Divina 3 Kvadrat. Elmosoft. Field Kvadrat. Hallingdal 65 Kvadrat. Revive 1 Kvadrat. Remix 3 Kvadrat. Coated fabric Valencia Spradling.

### Frame Base



### Shell



Available also in one colour version (please check section "Finishes").

### Armrest



# Catifa 46

Design by Lievore Altherr Molina, 2004

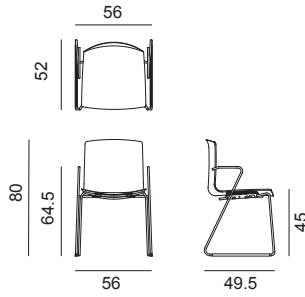

Chair with chromed steel sled base fitted with armrests. The shell is available in single-colour polypropylene, bi-colour polypropylene or covered in hard leather without padding. Optional glides with felt for wooden floors are available upon request.

**Accessories:**

- Link Art. 0258
- Stacking protection pad with link Art. 0260
- Cushion Art. 0261
- Stacking protection pad Art. 0262
- Writing tablet Art. 0264
- Stacking protection glide Art. 0286
- Removable cover Art. 0309
- Trolley Art. 0760

**Stackability:**

(should the weight exceed 25 kilos a handling tool must be used).

- without tools up to 10 units
- with trolley up to 20 units

- CT: with stacking pad, without tools up to 5 units
- CT: with stacking pad, with trolley up to 5 units
- CT with link: with stacking pad, without tools up to 5 units
- CT with link: with stacking pad, with trolley up to 5 units

- with tablet: without tools up to 5 units
- with tablet: with trolley up to 8 units

<b>SEK ART. 0287</b>	CT	PO bi-color	PO single-color	
CHROMED	6346	3203	2941	
Polypropylene fire retardant (only for PO)	+ 357 (For finishes: PO00101/109/112; for other colors qty min. 300 pcs)			
<b>SHIPMENT DETAILS</b>	<b>TECHNICAL SPECIFICATIONS</b>		<b>RESISTANCE TEST</b>	
<b>Art.0287</b> 1 pz = 2  - kg 10,62/ m³ 0,297 4 pz = 2  - kg 35,7/ m³ 0,392 	<b>Art.0287</b> *Classe 1, 2, 11M: fire retardant version available with surcharge and eventual minimum batch		<ul style="list-style-type: none"> <li>• TUV GS (EN16139)</li> </ul>	
<b>FIRE RETARDANT TEST</b>				
Classe 1 Omologazione Italia Polipropilene. • M2 Polipropilene.				

**Frame Base**



CRO



**Shell**



Available also in one colour version (please check section "Finishes").



Stackable



Standard: polycarbonate glide with polyurethane insert.



Upon request: polycarbonate glide with felt insert.



# Catifa 46

Design by Lievore Altherr Molina, 2004

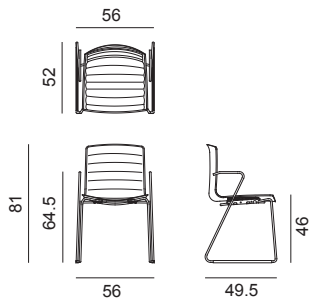

Chair with chromed steel sled base and shell upholstered in leather, coated fabric, fabric or customer's own material. Line detail stitching. Optional glides with felt for wooden floors are available upon request.

**Accessories:**

- Link Art. 0258
- Writing tablet Art. 0264
- Stacking protection pad with link Art. 0277
- Stacking protection pad Art. 0499
- Trolley Art. 0760

**Stackability:**

(should the weight exceed 25 kilos a handling tool must be used).

- with stacking pad, without tools up to 8 units
- with stacking pad, with trolley up to 8 units
- with link: with stacking pad, without tools up to 8 units
- with link: with stacking pad, with trolley up to 8 units
- leather / coated fabric: with stacking pad, without tools up to 5 units
- leather / coated fabric: with stacking pad, with trolley up to 5 units
- leather / coated fabric with link: with stacking pad, without tools up to 5 units
- leather / coated fabric with link: with stacking pad, with trolley up to 5 units
- with tablet: with stacking pad, without tools up to 5 units
- with tablet: with stacking pad, with trolley up to 5 units
- with tablet with link: with stacking pad, without tools up to 5 units
- with tablet with link: with stacking pad, with trolley up to 5 units

SEK ART. 0289	A	B COM	C COL	D	E	F	G	H	I	J	K	L	M	ES
CHROMED	5930	6240	6550	6860	7170	7480	7790	8100	8410	8720	9030	9340	9650	10799
<b>SHIPMENT DETAILS</b>		<b>TECHNICAL SPECIFICATIONS</b>					<b>RESISTANCE TEST</b>							
<b>Art.0289</b> 1 pz = 2  - kg 11,92/ m³ 0,319 4 pz = 2  - kg 41,7/ m³ 0,448 		<b>Art.0289</b> COL requirement m² 1.67 H 140 cm. COM Meterage m 1.1 *Classe 1, 2, 11M: fire retardant version available with surcharge and eventual minimum batch					<ul style="list-style-type: none"> <li>• TUV GS (EN16139)</li> </ul>							
<b>FIRE RETARDANT TEST</b>														
Classe 11M Omologazione Italia Divina MD Kvadrat. Divina Melange 3 Kvadrat. Divina 3 Kvadrat. Field Kvadrat. Coated fabric Valencia Spradling. • FIRE RETARDANT VERSION WITH SURCHARGE * Classe 11M Omologazione Italia Elmosoft. Revive 1 Kvadrat. Steelcut Trio 3 Kvadrat.														

**Frame Base**

CRO



# Catifa 46

Design by Lievore Altherr Molina, 2013

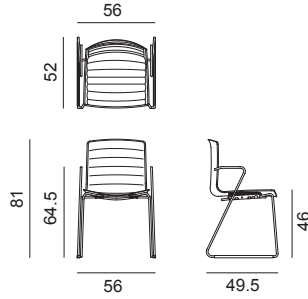

Chair with chromed steel sled base and polypropylene shell upholstered with a removable non-washable cover in leather, coated fabric, fabric or customer's own material. The cover stitching comes in the same color as the upholstery. Stitching on cover 1 and 3 comes in white or black, to customer's choice. The chair is provided already fitted with the cover. Optional glides with felt for wooden floors are available upon request.

Accessories:  
 Link Art. 0258  
 Writing tablet Art. 0264  
 Stacking protection pad with link Art. 0277  
 Stacking protection glide Art. 0286  
 Stacking protection pad Art. 0499  
 Trolley Art. 0760

**Stackability:**

(should the weight exceed 25 kilos a handling tool must be used).

- with stacking pad, without tools up to 8 units
- with stacking pad, with trolley up to 8 units
- with link: with stacking pad, without tools up to 8 units
- with link: with stacking pad, with trolley up to 8 units
- leather / coated fabric: with stacking pad, without tools up to 5 units
- leather / coated fabric: with stacking pad, with trolley up to 5 units
- leather / coated fabric with link: with stacking pad, without tools up to 5 units
- leather / coated fabric with link: with stacking pad, with trolley up to 5 units
- with tablet: with stacking pad, without tools up to 5 units
- with tablet: with stacking pad, with trolley up to 5 units
- with tablet with link: with stacking pad, without tools up to 5 units
- with tablet with link: with stacking pad, with trolley up to 5 units

SEK ART. 0313	A	B COM	C COL	D	E	F	G	H	I	J	K	L	M	ES
CHROMED - Cover 1	5870	6180	6490	6800	7110	7420	7730	8040	8350	8660	8970	9280	9590	10740
CHROMED - Cover 2	5989	6299	6609	6919	7229	7539	7849	8159	8469	8779	9089	9399	9709	10872
CHROMED - Cover 3	5870	6180	6490	6800	7110	7420	7730	8040	8350	8660	8970	9280	9590	10740
CHROMED - Cover 4	5429	5739	6049	6359	6669	6979	7289	7599	7909	8219	8529	8839	9149	10323

SHIPMENT DETAILS	TECHNICAL SPECIFICATIONS	RESISTANCE TEST
<b>Art.0313</b> 1 pz = 2  - kg 11,92/ m³ 0,319 4 pz = 2  - kg 41,7/ m³ 0,448 	<b>Art.0313</b> COL requirement m² 1.97 H 140 cm. COM Meterage m 1.08 *Classe 1, 2, 11M: fire retardant version available with surcharge and eventual minimum batch	• TUV GS (EN16139)
<b>FIRE RETARDANT TEST</b> Classe 11M Omologazione Italia Divina MD Kvadrat. Divina Melange 3 Kvadrat. Divina 3 Kvadrat. Field Kvadrat. Coated fabric Valencia Spradling. • FIRE RETARDANT VERSION WITH SURCHARGE * Classe 11M Omologazione Italia Elmosoft. Revive 1 Kvadrat. Steelcut Trio 3 Kvadrat.		

**Frame Base**

CRO



# Catifa 46

Design by Lievore Altherr Molina, 2004

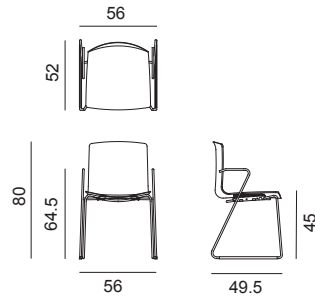

Chair with chromed steel sled base fitted with armrests. Oak-effect reconstituted veneer shell available in three finishes (natural oak, bleached oak, wengé). Optional glides with felt for wooden floors are available upon request.

Accessories:  
 Link Art. 0258  
 Cushion Art. 0261  
 Writing tablet Art. 0264  
 Stacking protection glide Art. 0286  
 Trolley Art. 0760

**Stackability:**

(should the weight exceed 25 kilos a handling tool must be used).

- with stacking pad, without tools up to 10 units
- with stacking pad, with trolley up to 10 units

- with tablet: with stacking pad, without tools up to 5 units
- with tablet: with stacking pad, with trolley up to 5 units

<b>SEK ART. 0387</b>	WOOD	
CHROMED	6323	
<b>SHIPMENT DETAILS</b>	<b>TECHNICAL SPECIFICATIONS</b>	<b>RESISTANCE TEST</b>
<b>Art.0387</b> 1 pz = 2  - kg 10,1/ m³ 0,295 4 pz = 2  - kg 33,6/ m³ 0,404 	<b>Art.0387</b> *Classe 1, 2, 1IM: fire retardant version available with surcharge and eventual minimum batch	• TUV GS (EN16139)
<b>FIRE RETARDANT TEST</b>		
• FIRE RETARDANT VERSION WITH SURCHARGE * Classe 1 Omologazione Italia Legno.		

**Frame Base**

CRO



**Shell**

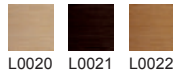

Stackable



Standard: polycarbonate glide with polyurethane insert.



Upon request: polycarbonate glide with felt insert.



# Catifa 46

Design by Lievore Altherr Molina, 2004

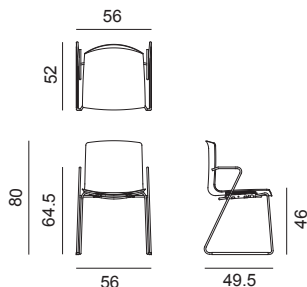

Chair with chromed steel sled base, fitted with armrests. Polypropylene shell with front upholstery in leather, coated fabric, fabric or customer's own material. Optional glides with felt for wooden floors are available upon request.

Accessories:  
 Link Art. 0258  
 Writing tablet Art. 0264  
 Stacking protection pad with link Art. 0277  
 Stacking protection pad Art. 0499  
 Trolley Art. 0760

### Stackability:

(should the weight exceed 25 kilos a handling tool must be used).

- with stacking pad, without tools up to 8 units
- with stacking pad, with trolley up to 8 units
- with link: with stacking pad, without tools up to 8 units
- with link: with stacking pad, with trolley up to 8 units
- leather / coated fabric: with stacking pad, without tools up to 5 units
- leather / coated fabric: with stacking pad, with trolley up to 5 units
- leather / coated fabric with link: with stacking pad, without tools up to 5 units
- leather / coated fabric with link: with stacking pad, with trolley up to 5 units
- with tablet: with stacking pad, without tools up to 5 units
- with tablet: with stacking pad, with trolley up to 5 units
- with tablet with link: with stacking pad, without tools up to 5 units
- with tablet with link: with stacking pad, with trolley up to 5 units

SEK ART. 0470	A	B COM	C COL	D	E	F	G	H	I	J	K	L	M	ES
CHROMED	5811	5965	6119	6273	6427	6581	6735	6889	7043	7197	7351	7505	7659	9299

SHIPMENT DETAILS	TECHNICAL SPECIFICATIONS	RESISTANCE TEST
<b>Art.0470</b> 1 pz = 2  - kg 13,32/ m² 0,326 4 pz = 2  - kg 43,12/ m² 0,456 KD	<b>Art.0470</b> COL requirement m² 0.94 H 140 cm. COM Meterage m 0.65	• TUV GS (EN16139)

**FIRE RETARDANT TEST**  
 Classe 1IM Omologazione Italia Divina MD Kvadrat. Divina Melange 3 Kvadrat. Divina 3 Kvadrat. Elmosoft. Field Kvadrat. Hallingdal 65 Kvadrat. Revive 1 Kvadrat. Remix 3 Kvadrat. Coated fabric Valencia Spradling.

### Frame Base



CRO



### Shell



Stackable



Standard: polycarbonate glide with polyurethane insert.



Upon request: polycarbonate glide with felt insert.



# Catifa 46

Design by Lievore Altherr Molina, 2014

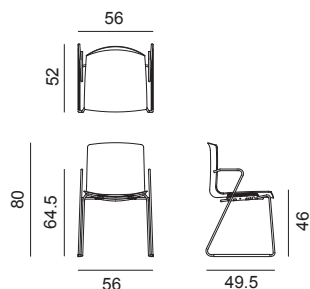

Chair with chromed steel sled base, fitted with armrests. Oak-effect reconstituted veneer shell available in three finishes (natural oak, bleached oak, wengé). Front upholstery in fabric or customer's own material. Glides for wooden floors available upon request without surcharge.

#### Accessories:

- Link Art. 0258
- Writing tablet Art. 0264
- Stacking protection pad with link Art. 0277
- Stacking protection pad Art. 0499
- Trolley Art. 0760

#### Stackability:

(should the weight exceed 25 kilos a handling tool must be used).

- with stacking pad, without tools up to 8 units
- with stacking pad, with trolley up to 8 units
- with link: with stacking pad, without tools up to 8 units
- with link: with stacking pad, with trolley up to 8 units
- with tablet: with stacking pad, without tools up to 5 units
- with tablet: with stacking pad, with trolley up to 5 units
- with tablet with link: with stacking pad, without tools up to 5 units
- with tablet with link: with stacking pad, with trolley up to 5 units

SEK ART. 0327	A	B COM	C	D	E	F	G	H	I	J	K	L	M
CHROMED	9252	9406	9560	9714	9868	10022	10176	10330	10484	10638	10792	10946	11100

SHIPMENT DETAILS	TECHNICAL SPECIFICATIONS	RESISTANCE TEST
<b>Art.0327</b> 1 pz = 2  - kg 13,32/ m² 0,326 4 pz = 2  - kg 43,12/ m² 0,456 	<b>Art.0327</b> H 140 cm. COM Meterage m 0.65	<ul style="list-style-type: none"> <li>• TUV GS (EN16139)</li> </ul>
<b>FIRE RETARDANT TEST</b> Classe 1IM Omologazione Italia Remix 3 Kvadrat.		

#### Frame Base



CRO



#### Shell

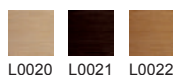

L0020 L0021 L0022



Stackable



Standard: polycarbonate glide with polyurethane insert.



Upon request: polycarbonate glide with felt insert.





# Catifa 46

Design by Lievore Altherr Molina, 2012

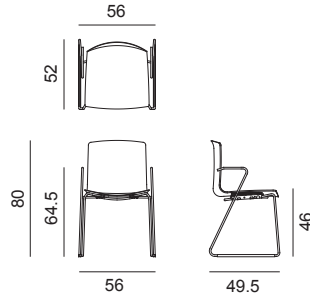

Chair with chromed steel sled base, fitted with armrests. Polypropylene shell with cushion upholstered in fabric, leather, coated fabric or customer's own material applied to the seat surface. Optional glides with felt for wooden floors are available upon request.

Accessories:  
 Link Art. 0258  
 Writing tablet Art. 0264  
 Stacking protection pad with link Art. 0277  
 Stacking protection pad Art. 0499  
 Trolley Art. 0760

### Stackability:

(should the weight exceed 25 kilos a handling tool must be used).

- with stacking pad, without tools up to 8 units
- with stacking pad, with trolley up to 8 units
- with link: with stacking pad, without tools up to 8 units
- with link: with stacking pad, with trolley up to 8 units
- leather / coated fabric: with stacking pad, without tools up to 5 units
- leather / coated fabric: with stacking pad, with trolley up to 5 units
- leather / coated fabric with link: with stacking pad, without tools up to 5 units
- leather / coated fabric with link: with stacking pad, with trolley up to 5 units
- with tablet: with stacking pad, without tools up to 5 units
- with tablet: with stacking pad, with trolley up to 5 units
- with tablet with link: with stacking pad, without tools up to 5 units
- with tablet with link: with stacking pad, with trolley up to 5 units

SEK ART. 0454	A	B COM	C COL	D	E	F	G	H	I	J	K	L	M	ES
PO Bicolors	5168	5239	5310	5381	5452	5523	5594	5665	5736	5807	5878	5949	6020	6346
PO single-color	4906	4977	5048	5119	5190	5261	5332	5403	5474	5545	5616	5687	5758	6072

SHIPMENT DETAILS	TECHNICAL SPECIFICATIONS	RESISTANCE TEST
<b>Art.0454</b> 1 pz = 2  - kg 13,32/ m³ 0,326 4 pz = 2  - kg 43,12/ m³ 0,456 KD	<b>Art.0454</b> COL requirement m² 0.48 H 140 cm. COM Meterage m 0.59	• TUV GS (EN16139)

**FIRE RETARDANT TEST**  
 Classe 11M Omologazione Italia Divina MD Kvadrat. Divina Melange 3 Kvadrat. Divina 3 Kvadrat. Elmosoft. Field Kvadrat. Hallingdal 65 Kvadrat. Revive 1 Kvadrat. Remix 3 Kvadrat. Coated fabric Valencia Spradling.

### Frame Base



CRO



### Shell



PO00204 PO00205 PO00209 PO00212 PO00213 PO00214 PO00215 PO00216 PO00217 PO00218

Available also in one colour version (please check section "Finishes").



Stackable



Standard: polycarbonate glide with polyurethane insert.



Upon request: polycarbonate glide with felt insert.



# Catifa 46

Design by Lievore Altherr Molina, 2004

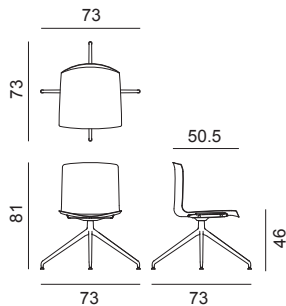

Chair with polished or powdercoated aluminium swivel trestle base. The shell is available in single-colour polypropylene, bi-colour polypropylene or covered in hard leather without padding. Polypropylene and steel armrests, are available upon request.

Accessories:  
Cushion Art. 0261  
Removable cover Art. 0309  
Set of glides Art. 2015

SEK ART. 0368	CT	PO bi-color	PO single-color	
POLISHED / POWDERCOATED	7215	4072	3810	
Armrests BV	+ 1083			
Armrests CV - pad (only for PO)	+ 334			
Polypropylene fire retardant (only for PO)	+ 357 (For finishes: PO00101/109/112; for other colors qty min. 300 pcs)			
SHIPMENT DETAILS	TECHNICAL SPECIFICATIONS		RESISTANCE TEST	
<b>Art.0368</b> 1 pz = 2  - kg 10,1/ m³ 0,245 1 pz = 3  - kg 12,48/ m³ 0,274 4 pz = 2  - kg 30,4/ m³ 0,336 4 pz = 3  - kg 38,54/ m³ 0,372 	<b>Art.0368</b> *Classe 1, 2, 11M: fire retardant version available with surcharge and eventual minimum batch		<ul style="list-style-type: none"> <li>• EN 1728:2012 - EN 16139:2013 6.10</li> <li>• EN 1728:2012 - EN 16139:2013 6.15</li> <li>• EN 1728:2012 - EN 16139:2013 6.17</li> <li>• EN 1728:2012 - EN 16139:2013 6.20</li> <li>• EN 1728:2012 - EN 16139:2013 6.5</li> <li>• EN 1728:2012 - EN 16139:2013 6.6</li> </ul> <ul style="list-style-type: none"> <li>• EN 1728:2012 - EN 16139:2013 6.11</li> <li>• EN 1728:2012 - EN 16139:2013 6.16</li> <li>• EN 1728:2012 - EN 16139:2013 6.18</li> <li>• EN 1728:2012 - EN 16139:2013 6.4</li> <li>• TUV GS (EN16139)</li> </ul>	
FIRE RETARDANT TEST				
Classe 1 Omologazione Italia Polipropilene. • M2 Polipropilene.				

## Frame Base



## Shell



Available also in one colour version (please check section "Finishes" ).

## Armrest



# Catifa 46

Design by Lievore Altherr Molina, 2004

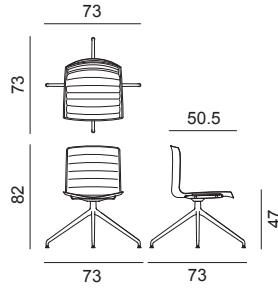

Chair with polished or powdercoated aluminium swivel trestle base. The shell is upholstered in leather, coated fabric, fabric or customer's own material. Line detail stitching. Steel armrests, also upholstered, are available upon request.

Accessories:  
Set of glides Art. 2015

SEK ART. 0375	A	B COM	C COL	D	E	F	G	H	I	J	K	L	M	ES
POLISHED / POWDERCOATED	6799	7109	7419	7729	8039	8349	8659	8969	9279	9589	9899	10209	10519	11668
Armrests BV	+ 1083													
Armrests CI - only pad	+ 727													
SHIPMENT DETAILS	TECHNICAL SPECIFICATIONS				RESISTANCE TEST									
<b>Art.0375</b> 1 pz = 2  - kg 11,4/ m³ 0,267 1 pz = 3  - kg 13,78/ m³ 0,296 4 pz = 2  - kg 36,4/ m³ 0,392 4 pz = 3  - kg 44,54/ m³ 0,428 	<b>Art.0375</b> COL requirement m² 1.67 H 140 cm. COM Meterage m 1.1 *Classe 1, 2, 1IM: fire retardant version available with surcharge and eventual minimum batch				<ul style="list-style-type: none"> <li>TUV GS (EN16139)</li> </ul>									
FIRE RETARDANT TEST														
Classe 1IM Omologazione Italia Divina MD Kvadrat. Divina Melange 3 Kvadrat. Divina 3 Kvadrat. Field Kvadrat. Coated fabric Valencia Spradling. • FIRE RETARDANT VERSION WITH SURCHARGE • Classe 1IM Omologazione Italia Elmosoft. Revive 1 Kvadrat. Steelcut Trio 3 Kvadrat.														

## Frame Base



## Armrest



# Catifa 46

Design by Lievore Altherr Molina, 2013

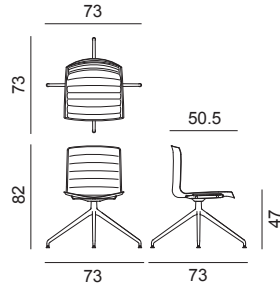

Chair with polished or powder-coated aluminium swivel trestle base. The white polypropylene shell (PO101) is upholstered with a removable non-washable cover in leather, coated fabric, fabric or customer's own material. The cover stitching comes in the same color as the upholstery. Stitching on cover 1 and 3 comes in white or black, to customer's choice. The chair is provided already fitted with the cover. Steel armrests are available upon request.

Accessories:  
Set of glides Art. 2015

SEK ART. 0316	A	B COM	C COL	D	E	F	G	H	I	J	K	L	M	ES
POLISHED / POWDERCOATED - Cover 1	6739	7049	7359	7669	7979	8289	8599	8909	9219	9529	9839	10149	10459	11609
POLISHED / POWDERCOATED - Cover 2	6858	7168	7478	7788	8098	8408	8718	9028	9338	9648	9958	10268	10578	11741
POLISHED / POWDERCOATED - Cover 3	6739	7049	7359	7669	7979	8289	8599	8909	9219	9529	9839	10149	10459	11609
POLISHED / POWDERCOATED - Cover 4	6298	6608	6918	7228	7538	7848	8158	8468	8778	9088	9398	9708	10018	11192
Armrests BV	+ 1083													

SHIPMENT DETAILS	TECHNICAL SPECIFICATIONS	RESISTANCE TEST
<b>Art.0316</b> 1 pz = 2  - kg 11,4/ m³ 0,267 1 pz = 3  - kg 13,78/ m³ 0,296 4 pz = 2  - kg 36,4/ m³ 0,392 4 pz = 3  - kg 44,54/ m³ 0,428 	<b>Art.0316</b> COL requirement m² 1.97 H 140 cm. COM Meterage m 1.08 *Classe 1, 2, 1IM: fire retardant version available with surcharge and eventual minimum batch	<ul style="list-style-type: none"> <li>TUV GS (EN16139)</li> </ul>

**FIRE RETARDANT TEST**  
 Classe 1IM Omologazione Italia Divina MD Kvadrat. Divina Melange 3 Kvadrat. Divina 3 Kvadrat. Field Kvadrat. Coated fabric Valencia Spradling.  
 • FIRE RETARDANT VERSION WITH SURCHARGE \* Classe 1IM Omologazione Italia Elmosoft. Revive 1 Kvadrat. Steelcut Trio 3 Kvadrat.

## Frame Base



## Armrest



# Catifa 46

Design by Lievore Altherr Molina, 2004

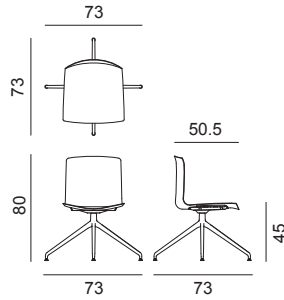

Chair with polished or powder-coated aluminium swivel trestle base. Oak-effect reconstituted veneer shell available in three finishes (natural oak, bleached oak, wengé). Steel armrests are available upon request.

Accessories:  
Cushion Art. 0261  
Set of glides Art. 2015

<b>SEK ART. 0377</b>	<b>WOOD</b>	
POLISHED / POWDERCOATED	7192	
Armrests BV	+ 1083	
<b>SHIPMENT DETAILS</b>	<b>TECHNICAL SPECIFICATIONS</b>	<b>RESISTANCE TEST</b>
<b>Art.0377</b> 1 pz = 2  - kg 9,58/ m³ 0,243 1 pz = 3  - kg 11,96/ m³ 0,272 4 pz = 2  - kg 28,3/ m³ 0,348 4 pz = 3  - kg 36,44/ m³ 0,384 	<b>Art.0377</b> *Classe 1, 2, 11M: fire retardant version available with surcharge and eventual minimum batch	<ul style="list-style-type: none"> <li>• EN 1728:2012 - EN 16139:2013 6.17</li> <li>• EN 1728:2012 - EN 16139:2013 6.24</li> <li>• EN 1728:2012 - EN 16139:2013 6.4</li> <li>• TUV GS (EN16139)</li> <li>• EN 1022:2018 7.2</li> </ul> <ul style="list-style-type: none"> <li>• EN 1728:2012 - EN 16139:2013 6.18</li> <li>• EN 1728:2012 - EN 16139:2013 6.25</li> <li>• EN 1728:2012 - EN 16139:2013 6.5</li> <li>• EN 1728:2012 - EN 16139:2013 6. 6</li> </ul>
<b>FIRE RETARDANT TEST</b>		
• FIRE RETARDANT VERSION WITH SURCHARGE * Classe 1 Omologazione Italia Legno.		

## Frame Base



## Shell

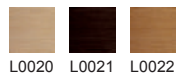

## Armrest



# Catifa 46

Design by Lievore Altherr Molina, 2004

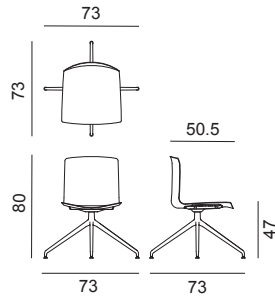

Chair with polished or powder-coated aluminium swivel trestle base. Polypropylene shell with front upholstery in leather, coated fabric, fabric or customer's own material. Steel armrests, also upholstered, are available upon request.

Accessories:  
Set of glides Art. 2015

SEK ART. 0370	A	B COM	C COL	D	E	F	G	H	I	J	K	L	M	ES
POLISHED / POWDERCOATED	6680	6834	6988	7142	7296	7450	7604	7758	7912	8066	8220	8374	8528	10168
Armrests BV	+ 1083													
Armrests CI - only pad	+ 727													
SHIPMENT DETAILS	TECHNICAL SPECIFICATIONS				RESISTANCE TEST									
<b>Art.0370</b> 1 pz = 2  - kg 12,8/ m³ 0,274 1 pz = 3  - kg 15,18/ m³ 0,303 4 pz = 2  - kg 37,84/ m³ 0,4 4 pz = 3  - kg 45,98/ m³ 0,436 	<b>Art.0370</b> COL requirement m² 0.94 H 140 cm. COM Meterage m 0.65				• TUV GS (EN16139)									
FIRE RETARDANT TEST														
Classe 1IM Omologazione Italia Divina MD Kvadrat. Divina Melange 3 Kvadrat. Divina 3 Kvadrat. Elmosof. Field Kvadrat. Hallingdal 65 Kvadrat. Remix 3 Kvadrat. Coated fabric Valencia Spradling.														

## Frame Base



## Shell



## Armrest



# Catifa 46

Design by Lievore Altherr Molina, 2014

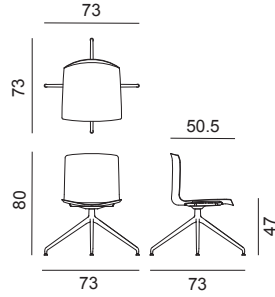

Chair with polished or powder-coated aluminium swivel trestle base. Oak-effect reconstituted veneer shell available in three finishes (natural oak, bleached oak, wengé). Front upholstery in fabric or customer's own material. Steel armrests, also upholstered, are available upon request.

Accessories:  
Set of glides Art. 2015

SEK ART. 0332	A	B COM	C	D	E	F	G	H	I	J	K	L	M
POLISHED / POWDERCOATED	10121	10275	10429	10583	10737	10891	11045	11199	11353	11507	11661	11815	11969
Armrests BV	+ 1083												
Armrests CI - only pad	+ 727												
SHIPMENT DETAILS	TECHNICAL SPECIFICATIONS				RESISTANCE TEST								
<b>Art.0332</b> 1 pz = 2  - kg 12,8/ m³ 0,274 1 pz = 3  - kg 15,18/ m³ 0,303 4 pz = 2  - kg 37,84/ m³ 0,4 4 pz = 3  - kg 45,98/ m³ 0,436 	<b>Art.0332</b> H 140 cm. COM Meterage m 0.65				<ul style="list-style-type: none"> <li>TUV GS (EN16139)</li> </ul>								
FIRE RETARDANT TEST													
Classe 1IM Omologazione Italia Remix 3 Kvadrat.													

## Frame Base



## Shell

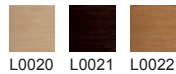

## Armrest



# Catifa 46

Design by Lievore Altherr Molina, 2012

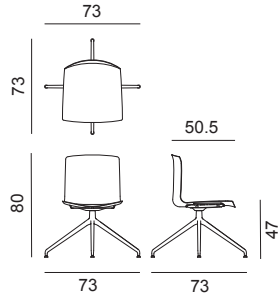

Chair with polished or powder-coated aluminium swivel trestle base. Polypropylene shell with cushion upholstered in fabric, leather, coated fabric or customer's own material applied to the seat surface. Steel armrests, also upholstered, are available upon request.

Accessories:  
Set of glides Art. 2015

SEK ART. 0279	A	B COM	C COL	D	E	F	G	H	I	J	K	L	M	ES
PO Bicolors	6037	6108	6179	6250	6321	6392	6463	6534	6605	6676	6747	6818	6889	7215
PO single-color	5775	5846	5917	5988	6059	6130	6201	6272	6343	6414	6485	6556	6627	6941
Armrests BV	+ 1083													
Armrests CI - only pad	+ 727													
SHIPMENT DETAILS	TECHNICAL SPECIFICATIONS				RESISTANCE TEST									
<b>Art.0279</b> 1 pz = 2  - kg 12,8/ m³ 0,274 1 pz = 3  - kg 15,18/ m³ 0,303 4 pz = 2  - kg 37,84/ m³ 0,4 4 pz = 3  - kg 45,98/ m³ 0,436 KD	<b>Art.0279</b> COL requirement m² 0.48 H 140 cm. COM Meterage m 0.59				• TUV GS (EN16139)									
FIRE RETARDANT TEST														
Classe 1IM Omologazione Italia Divina MD Kvadrat. Divina Melange 3 Kvadrat. Divina 3 Kvadrat. Field Kvadrat. Hallingdal 65 Kvadrat. Revive 1 Kvadrat. Remix 3 Kvadrat. Coated fabric Valencia Spradling.														

## Frame Base



## Shell



Available also in one colour version (please check section "Finishes").

## Armrest





# Catifa 46

Design by Lievore Altherr Molina, 2004

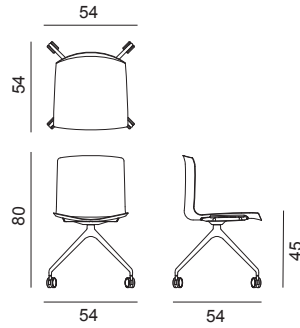

Chair with polished or powdercoated aluminium fixed trestle base, mounted on self-braking castors (color matching with base). The shell is available in single-colour polypropylene, bi colour polypropylene or upholstered in hard leather without padding. Polypropylene and steel armrests, are available upon request.

Accessories:  
Cushion Art. 0261  
Removable cover Art. 0309

SEK ART. 0369	CT	PO bi-color	PO single-color	
POLISHED / POWDERCOATED	7620	4477	4215	
Armrests BV	+ 1083			
Armrests CV - pad (only for PO)	+ 334			
Polypropylene fire retardant (only for PO)	+ 357 (For finishes: PO00101/109/112; for other colors qty min. 300 pcs)			
SHIPMENT DETAILS	TECHNICAL SPECIFICATIONS		RESISTANCE TEST	
<b>Art.0369</b> 1 pz = 2  - kg 10,2/ m³ 0,251 1 pz = 3  - kg 12,58/ m³ 0,28 4 pz = 2  - kg 30,8/ m³ 0,34 4 pz = 3  - kg 38,94/ m³ 0,376 	<b>Art.0369</b> *Classe 1, 2, 11M: fire retardant version available with surcharge and eventual minimum batch		<ul style="list-style-type: none"> <li>• EN 1728:2012 - EN 16139:2013 6.10</li> <li>• EN 1728:2012 - EN 16139:2013 6.15</li> <li>• EN 1728:2012 - EN 16139:2013 6.20</li> <li>• EN 1728:2012 - EN 16139:2013 6.5</li> <li>• EN 1728:2012 - EN 16139:2013 6.6</li> </ul>	
<b>FIRE RETARDANT TEST</b> Classe 1 Omologazione Italia Polipropilene. • M2 Polipropilene.				

## Frame Base



## Shell



Available also in one colour version (please check section "Finishes").

## Armrest



# Catifa 46

Design by Lievore Altherr Molina, 2004

Chair with polished or powdercoated aluminium fixed trestle base, mounted on self-braking castors (color matching with base). The shell is upholstered in leather, coated fabric, fabric or customer's own material. Line detail stitching. Steel armrests, also upholstered, are available upon request.

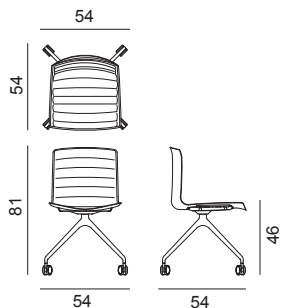

SEK ART. 0376	A	B COM	C COL	D	E	F	G	H	I	J	K	L	M	ES
POLISHED / POWDERCOATED	7204	7514	7824	8134	8444	8754	9064	9374	9684	9994	10304	10614	10924	12073
Armrests BV	+ 1083													
Armrests CI - only pad	+ 727													
SHIPMENT DETAILS	TECHNICAL SPECIFICATIONS				RESISTANCE TEST									
<b>Art.0376</b> 1 pz = 2  - kg 11,5/ m³ 0,273 1 pz = 3  - kg 13,88/ m³ 0,302 4 pz = 2  - kg 36,8/ m³ 0,396 4 pz = 3  - kg 44,94/ m³ 0,432 	<b>Art.0376</b> COL requirement m² 1.67 H 140 cm. COM Meterage m 1.1 *Classe 1, 2, 1IM: fire retardant version available with surcharge and eventual minimum batch				<ul style="list-style-type: none"> <li>TUV GS (EN16139)</li> </ul>									
FIRE RETARDANT TEST														
Classe 1IM Omologazione Italia Divina MD Kvadrat. Divina Melange 3 Kvadrat. Divina 3 Kvadrat. Field Kvadrat. Coated fabric Valencia Spradling. * FIRE RETARDANT VERSION WITH SURCHARGE * Classe 1IM Omologazione Italia Elmosoft. Revive 1 Kvadrat. Steelcut Trio 3 Kvadrat.														

## Frame Base



## Armrest



# Catifa 46

Design by Lievore Altherr Molina, 2013

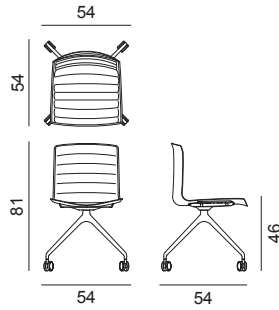

Chair with polished or powder-coated aluminium fixed trestle base, mounted on self-braking castors (color matching with base). The white polypropylene shell (PO101) is upholstered with a removable non-washable cover in leather, coated fabric, fabric or customer's own material. The cover stitching comes in the same color as the upholstery. Stitching on cover 1 and 3 comes in white or black, to customer's choice. The chair is provided already fitted with the cover. Steel armrests are available upon request.

SEK ART. 0317	A	B COM	C COL	D	E	F	G	H	I	J	K	L	M	ES
POLISHED / POWDERCOATED - Cover 1	7144	7454	7764	8074	8384	8694	9004	9314	9624	9934	10244	10554	10864	12014
POLISHED / POWDERCOATED - Cover 2	7263	7573	7883	8193	8503	8813	9123	9433	9743	10053	10363	10673	10983	12146
POLISHED / POWDERCOATED - Cover 3	7144	7454	7764	8074	8384	8694	9004	9314	9624	9934	10244	10554	10864	12014
POLISHED / POWDERCOATED - Cover 4	6703	7013	7323	7633	7943	8253	8563	8873	9183	9493	9803	10113	10423	11597
Armrests BV	+ 1083													

SHIPMENT DETAILS	TECHNICAL SPECIFICATIONS	RESISTANCE TEST
<b>Art.0317</b> 1 pz = 2  - kg 11,5/ m³ 0,273 1 pz = 3  - kg 13,88/ m³ 0,302 4 pz = 2  - kg 36,8/ m³ 0,396 4 pz = 3  - kg 44,94/ m³ 0,432 KD	<b>Art.0317</b> COL requirement m² 1.97 H 140 cm. COM Meterage m 1.08 *Classe 1, 2, 11M: fire retardant version available with surcharge and eventual minimum batch	• TUV GS (EN16139)

**FIRE RETARDANT TEST**  
 Classe 11M Omologazione Italia Divina MD Kvadrat. Divina Melange 3 Kvadrat. Divina 3 Kvadrat. Field Kvadrat. Coated fabric Valencia Spradling.  
 • FIRE RETARDANT VERSION WITH SURCHARGE \* Classe 11M Omologazione Italia Elmosoft. Revive 1 Kvadrat. Steelcut Trio 3 Kvadrat.

### Frame Base



### Armrest



# Catifa 46

Design by Lievore Altherr Molina, 2004

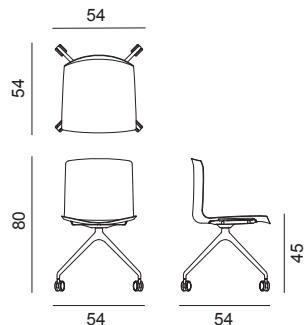

Chair with polished or powder-coated aluminium fixed trestle base, mounted on self-braking castors (colour matching with base). Oak-effect reconstituted veneer shell available in three finishes (natural oak, bleached oak, wengé). Steel armrests are available upon request.

Accessories:  
Cushion Art. 0261

<b>SEK ART. 0386</b>	WOOD	
POLISHED / POWDERCOATED	7597	
Armrests BV	+ 1083	
<b>SHIPMENT DETAILS</b>	<b>TECHNICAL SPECIFICATIONS</b>	<b>RESISTANCE TEST</b>
<b>Art.0386</b> 1 pz = 2  - kg 9,68/ m³ 0,249 1 pz = 3  - kg 12,6/ m³ 0,278 4 pz = 2  - kg 28,7/ m³ 0,352 4 pz = 3  - kg 36,84/ m³ 0,388 	<b>Art.0386</b> *Classe 1, 2, 11M: fire retardant version available with surcharge and eventual minimum batch	<ul style="list-style-type: none"> <li>TUV GS (EN16139)</li> </ul>
<b>FIRE RETARDANT TEST</b>		
• FIRE RETARDANT VERSION WITH SURCHARGE * Classe 1 Omologazione Italia Legno.		

## Frame Base



## Shell

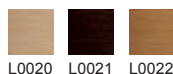

## Armrest



# Catifa 46

Design by Lievore Altherr Molina, 2004

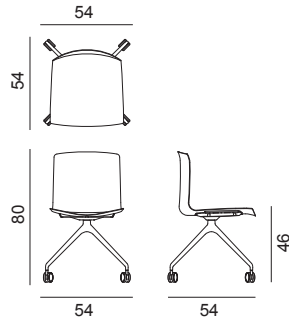

Chair with polished or powder-coated aluminium fixed trestle, mounted on self-braking castors (color matching with base). Polypropylene shell with front upholstery in leather, coated fabric, fabric or customer's own material. Steel armrests, also upholstered, are available upon request.

SEK ART. 0372	A	B COM	C COL	D	E	F	G	H	I	J	K	L	M	ES
POLISHED / POWDERCOATED	7085	7239	7393	7547	7701	7855	8009	8163	8317	8471	8625	8779	8933	10573
Armrests BV	+ 1083													
Armrests CI - only pad	+ 727													
SHIPMENT DETAILS	TECHNICAL SPECIFICATIONS				RESISTANCE TEST									
<b>Art.0372</b> 1 pz = 2  - kg 12,9/ m³ 0,28 1 pz = 3  - kg 15,28/ m³ 0,309 4 pz = 2  - kg 38,24/ m³ 0,404 4 pz = 3  - kg 46,38/ m³ 0,44 (KD)	<b>Art.0372</b> COL requirement m² 0.94 H 140 cm. COM Meterage m 0.65				• TUV GS (EN16139)									
FIRE RETARDANT TEST														
Classe 1IM Omologazione Italia Divina MD Kvadrat. Divina Melange 3 Kvadrat. Divina 3 Kvadrat. Elmosoft. Field Kvadrat. Hallingdal 65 Kvadrat. Remix 3 Kvadrat. Coated fabric Valencia Spradling.														

## Frame Base



## Shell



## Armrest



# Catifa 46

Design by Lievore Altherr Molina, 2014

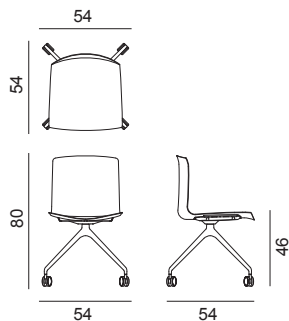

Chair with polished or powder-coated aluminium fixed trestle, mounted on self-braking castors (colour matching with base). Oak-effect reconstituted veneer shell available in three finishes (natural oak, bleached oak, wengé). Front upholstery in fabric or customer's own material. Steel armrests, also upholstered, are available upon request.

SEK ART. 0333	A	B COM	C	D	E	F	G	H	I	J	K	L	M
POLISHED / POWDERCOATED	10526	10680	10834	10988	11142	11296	11450	11604	11758	11912	12066	12220	12374
Armrests BV	+ 1083												
Armrests CI - only pad	+ 727												
SHIPMENT DETAILS	TECHNICAL SPECIFICATIONS				RESISTANCE TEST								
<b>Art.0333</b> 1 pz = 2  - kg 12,9/ m³ 0,28 1 pz = 3  - kg 15,28/ m³ 0,309 4 pz = 2  - kg 38,24/ m³ 0,404 4 pz = 3  - kg 46,38/ m³ 0,44 KD	<b>Art.0333</b> H 140 cm. COM Meterage m 0.65				• TUV GS (EN16139)								
FIRE RETARDANT TEST													
Classe 1IM Omologazione Italia Remix 3 Kvadrat.													

## Frame Base



## Shell

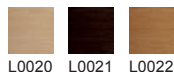

## Armrest



# Catifa 46

Design by Lievore Altherr Molina, 2012

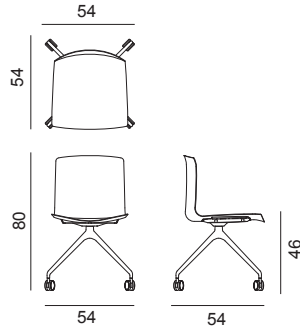

Chair with polished or powder-coated aluminium fixed trestle, mounted on self-braking castors (color matching with base). Polypropylene shell with cushion upholstered in fabric, leather, coated fabric or customer's own material applied to the seat surface. Steel armrests, also upholstered, are available upon request.

SEK ART. 0290	A	B COM	C COL	D	E	F	G	H	I	J	K	L	M	ES
PO Bicolors	6442	6513	6584	6655	6726	6797	6868	6939	7010	7081	7152	7223	7294	7620
PO single-color	6180	6251	6322	6393	6464	6535	6606	6677	6748	6819	6890	6961	7032	7346
Armrests BV	+ 1083													
Armrests CI - only pad	+ 727													

SHIPMENT DETAILS	TECHNICAL SPECIFICATIONS	RESISTANCE TEST
<b>Art.0290</b> 1 pz = 2  - kg 12,9/ m³ 0,28 1 pz = 3  - kg 15,28/ m³ 0,309 4 pz = 2  - kg 38,24/ m³ 0,404 4 pz = 3  - kg 46,38/ m³ 0,44 	<b>Art.0290</b> COL requirement m² 0.48 H 140 cm. COM Meterage m 0.59	<ul style="list-style-type: none"> <li>TUV GS (EN16139)</li> </ul>

**FIRE RETARDANT TEST**  
 Classe 11M Omologazione Italia Divina MD Kvadrat. Divina Melange 3 Kvadrat. Divina 3 Kvadrat. Elmosoft. Field Kvadrat. Hallingdal 65 Kvadrat. Revive 1 Kvadrat. Remix 3 Kvadrat. Coated fabric Valencia Spradling.

## Frame Base



## Shell



Available also in one colour version (please check section "Finishes").

## Armrest



# Catifa 46

Design by Lievore Altherr Molina, 2004

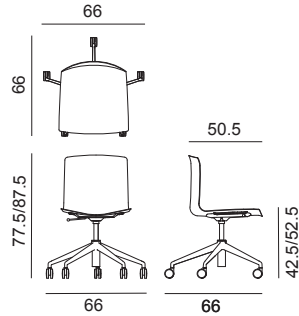

Chair with polished or powdercoated aluminum five-star swivel trestle base, mounted on selfbraking castors (color matching with base) and fitted with gas height adjustment mechanism. The shell is available in single-colour polypropylene, bi-colour polypropylene or upholstered in hard leather without padding. Polypropylene and steel armrests, also upholstered, are available upon request.

Accessories:  
Cushion Art. 0261  
Cover Art. 0309

SEK ART. 0380	CT	PO bi-color	PO single-color	
GAS MECHANISM	8930	5787	5525	
Armrests BV	+ 1083			
Armrests CV - pad (only for PO)	+ 334			
Polypropylene fire retardant (only for PO)	+ 357 (For finishes: PO00101/109/112; for other colors qty min. 300 pcs)			
SHIPMENT DETAILS	TECHNICAL SPECIFICATIONS		RESISTANCE TEST	
<b>Art.0380</b> 1 pz = 2  - kg 11,6/ m³ 0,304 1 pz = 3  - kg 13,98/ m³ 0,333 4 pz = 5  - kg 43,6/ m³ 0,968 4 pz = 6  - kg 51,76/ m³ 1,004 	<b>Art.0380</b> *Classe 1, 2, 11M: fire retardant version available with surcharge and eventual minimum batch		<ul style="list-style-type: none"> <li>• EN 1728:2012 - EN 16139:2013 6.17</li> <li>• EN 1728:2012 - EN 16139:2013 6.24</li> <li>• EN 1728:2012 - EN 16139:2013 6.5</li> <li>• EN 1728:2012 - EN 16139:2013 6.18</li> <li>• EN 1728:2012 - EN 16139:2013 6.4</li> <li>• TUV GS (EN16139)</li> </ul>	
FIRE RETARDANT TEST				
Classe 1 Omologazione Italia Polipropilene. • M2 Polipropilene.				

## Frame Base



## Shell



Available also in one colour version (please check section "Finishes" ).

## Armrest





# Catifa 46

Design by Lievore Altherr Molina, 2004

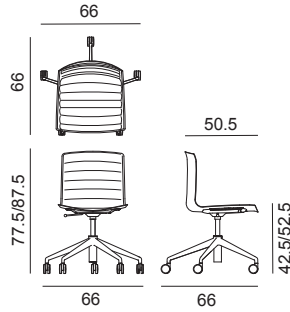

Chair with polished or powdercoated aluminum five-star swivel trestle base, mounted on selfbraking castors (color matching with base) and fitted with gas height adjustment mechanism. The shell is upholstered in leather, coated fabric, fabric or customer's own material. Line detail stitching. Steel armrests, also upholstered, are available upon request.

SEK ART. 0382	A	B COM	C COL	D	E	F	G	H	I	J	K	L	M	ES
GAS MECHANISM	8514	8824	9134	9444	9754	10064	10374	10684	10994	11304	11614	11924	12234	13383
Armrests BV	+ 1083													
Armrests CI - only pad	+ 727													
SHIPMENT DETAILS	TECHNICAL SPECIFICATIONS				RESISTANCE TEST									
<b>Art.0382</b> 1 pz = 2  - kg 12,9/ m³ 0,326 1 pz = 3  - kg 15,28/ m³ 0,355 4 pz = 5  - kg 49,6/ m³ 1,004 4 pz = 6  - kg 57,76/ m³ 1,06 	<b>Art.0382</b> COL requirement m² 1.67 H 140 cm. COM Meterage m 1.1 *Classe 1, 2, 11M: fire retardant version available with surcharge and eventual minimum batch				• TUV GS (EN16139)									
FIRE RETARDANT TEST														
Classe 11M Omologazione Italia Divina MD Kvadrat. Divina Melange 3 Kvadrat. Divina 3 Kvadrat. Field Kvadrat. Coated fabric Valencia Spradling. • FIRE RETARDANT VERSION WITH SURCHARGE • Classe 11M Omologazione Italia Elmosoft. Revive 1 Kvadrat. Steelcut Trio 3 Kvadrat.														

## Frame Base



## Armrest



# Catifa 46

Design by Lievore Altherr Molina, 2013

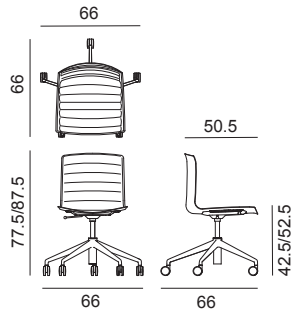

Chair with polished or powder-coated aluminum five-star swivel trestle base, mounted on selfbraking castors (color matching with base) and fitted with gas height adjustment mechanism. The white polypropylene shell (PO101) is upholstered with a removable non-washable cover in leather, coated fabric, fabric or customer's own material. The cover stitching comes in the same color as the upholstery. Stitching on cover 1 and 3 comes in white or black, to customer's choice. The chair is provided already fitted with the cover. Steel armrests are available upon request.

SEK ART. 0319	A	B COM	C COL	D	E	F	G	H	I	J	K	L	M	ES
GAS MECHANISM - Cover 1	8454	8764	9074	9384	9694	10004	10314	10624	10934	11244	11554	11864	12174	13324
GAS MECHANISM - Cover 2	8573	8883	9193	9503	9813	10123	10433	10743	11053	11363	11673	11983	12293	13456
GAS MECHANISM - Cover 3	8454	8764	9074	9384	9694	10004	10314	10624	10934	11244	11554	11864	12174	13324
GAS MECHANISM - Cover 4	8013	8323	8633	8943	9253	9563	9873	10183	10493	10803	11113	11423	11733	12907
Armrests BV	+ 1083													

SHIPMENT DETAILS	TECHNICAL SPECIFICATIONS	RESISTANCE TEST
<b>Art.0319</b> 1 pz = 2  - kg 12,9/ m³ 0,326 1 pz = 3  - kg 15,28/ m³ 0,355 4 pz = 5  - kg 49,6/ m³ 1,004 4 pz = 6  - kg 57,76/ m³ 1,06 KD	<b>Art.0319</b> COL requirement m² 1.97 H 140 cm. COM Meterage m 1.08 *Classe 1, 2, 11M: fire retardant version available with surcharge and eventual minimum batch	• TUV GS (EN16139)

**FIRE RETARDANT TEST**  
 Classe 11M Omologazione Italia Divina MD Kvadrat, Divina Melange 3 Kvadrat, Divina 3 Kvadrat, Field Kvadrat, Coated fabric Valencia Spradling.  
 • FIRE RETARDANT VERSION WITH SURCHARGE \* Classe 11M Omologazione Italia Elmosoft, Revive 1 Kvadrat, Steelcut Trio 3 Kvadrat.

## Frame Base



## Armrest



# Catifa 46

Design by Lievore Altherr Molina, 2004

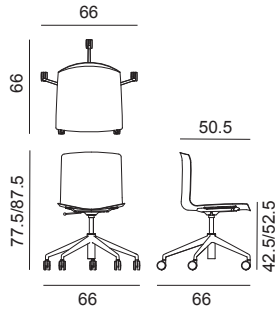

Chair with polished or powder-coated aluminium five-way swivel trestle base, mounted on selfbraking castors (colour matching with base) and fitted with gas height adjustment mechanism. Oak-effect reconstituted veneer shell available in three finishes (natural oak, bleached oak, wengé). Steel armrests are available upon request.

Accessories:  
Cushion Art. 0261

<b>SEK ART. 0352</b>	<b>WOOD</b>	
GAS MECHANISM	8907	
Armrests BV	+ 1083	
<b>SHIPMENT DETAILS</b>	<b>TECHNICAL SPECIFICATIONS</b>	<b>RESISTANCE TEST</b>
<b>Art.0352</b> 1 pz = 2  - kg 11,08/ m³ 0,302 1 pz = 3  - kg 13,46/ m³ 0,331 4 pz = 5  - kg 41,52/ m³ 0,98 4 pz = 6  - kg 49,64/ m³ 1,016 	<b>Art.0352</b> *Classe 1, 2, 11M: fire retardant version available with surcharge and eventual minimum batch	<ul style="list-style-type: none"> <li>TUV GS (EN16139)</li> </ul>
<b>FIRE RETARDANT TEST</b> Classe 11M Omologazione Italia Elmosoft. • FIRE RETARDANT VERSION WITH SURCHARGE * Classe 1 Omologazione Italia Legno.		

## Frame Base



## Shell

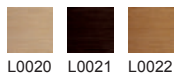

## Armrest



# Catifa 46

Design by Lievore Altherr Molina, 2004

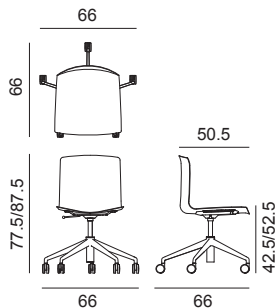

Chair with polished or powder-coated aluminum five-star swivel trestle base, mounted on selfbraking castors (color matching with base) and fitted with gas height adjustment mechanism. Polypropylene shell with front upholstery in leather, coated fabric, fabric or customer's own material. Steel armrests, also upholstered, are available upon request.

SEK ART. 0384	A	B COM	C COL	D	E	F	G	H	I	J	K	L	M	ES
GAS MECHANISM	8395	8549	8703	8857	9011	9165	9319	9473	9627	9781	9935	10089	10243	11883
Armrests BV	+ 1083													
Armrests CI - only pad	+ 727													
SHIPMENT DETAILS	TECHNICAL SPECIFICATIONS				RESISTANCE TEST									
<b>Art.0384</b> 1 pz = 2  - kg 14,3/ m³ 0,333 1 pz = 3  - kg 16,68/ m³ 0,362 4 pz = 5  - kg 51,04/ m³ 1,032 4 pz = 6  - kg 60,56/ m³ 1,068 KD	<b>Art.0384</b> COL requirement m² 0.94 H 140 cm. COM Meterage m 0.65				• TUV GS (EN16139)									
FIRE RETARDANT TEST														
Classe 1IM Omologazione Italia Divina MD Kvadrat. Divina Melange 3 Kvadrat. Divina 3 Kvadrat. Elmosoft. Field Kvadrat. Hallingdal 65 Kvadrat. Remix 3 Kvadrat. Coated fabric Valencia Spradling.														

## Frame Base



## Shell



## Armrest



# Catifa 46

Design by Lievore Altherr Molina, 2014

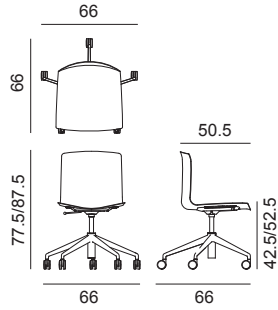

Chair with polished or powder-coated aluminium five-way swivel trestle base, mounted on selfbraking castors (colour matching with base) and fitted with gas height adjustment mechanism. Oak-effect reconstituted veneer shell available in three finishes (natural oak, bleached oak, wengé). Front upholstery in fabric or customer's own material. Steel armrests, also upholstered, are available upon request.

SEK ART. 0335	A	B COM	C	D	E	F	G	H	I	J	K	L	M
GAS MECHANISM	11836	11990	12144	12298	12452	12606	12760	12914	13068	13222	13376	13530	13684
Armrests BV	+ 1083												
Armrests CI - only pad	+ 727												
SHIPMENT DETAILS	TECHNICAL SPECIFICATIONS				RESISTANCE TEST								
<b>Art.0335</b> 1 pz = 2  - kg 14,3/ m³ 0,333 1 pz = 3  - kg 16,68/ m³ 0,362 4 pz = 5  - kg 51,04/ m³ 1,032 4 pz = 6  - kg 60,56/ m³ 1,068 	<b>Art.0335</b> H 140 cm. COM Meterage m 0.65				<ul style="list-style-type: none"> <li>TUV GS (EN16139)</li> </ul>								
FIRE RETARDANT TEST													
Classe 1IM Omologazione Italia Remix 3 Kvadrat.													

## Frame Base



## Shell

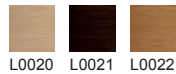

## Armrest



# Catifa 46

Design by Lievore Altherr Molina, 2012

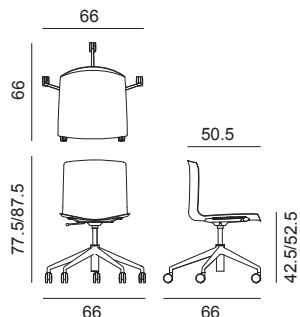

Chair with polished or powder-coated aluminum five-star swivel trestle base, mounted on selfbraking castors (color matching with base) and fitted with gas height adjustment mechanism. Polypropylene shell with cushion upholstered in fabric, leather, coated fabric or customer's own material applied to the seat surface. Steel armrests, also upholstered, are available upon request.

SEK ART. 0302	A	B COM	C COL	D	E	F	G	H	I	J	K	L	M	ES
GAS MECHANISM PO Bicolor	7752	7823	7894	7965	8036	8107	8178	8249	8320	8391	8462	8533	8604	8930
GAS MECHANISM PO single-color	7490	7561	7632	7703	7774	7845	7916	7987	8058	8129	8200	8271	8342	8656
Armrests BV	+ 1083													
Armrests CI - only pad	+ 727													

SHIPMENT DETAILS	TECHNICAL SPECIFICATIONS	RESISTANCE TEST
<b>Art.0302</b> 1 pz = 2  - kg 14,3/ m³ 0,36 1 pz = 3  - kg 16,68/ m³ 0,362 4 pz = 5  - kg 51,04/ m³ 1,104 4 pz = 6  - kg 60,56/ m³ 1,143 KD	<b>Art.0302</b> COL requirement m² 0.48 H 140 cm. COM Meterage m 0.59	• TUV GS (EN16139)

**FIRE RETARDANT TEST**  
 Classe 11M Omologazione Italia Divina MD Kvadrat. Divina Melange 3 Kvadrat. Divina 3 Kvadrat. Elmosof. Field Kvadrat. Hallingdal 65 Kvadrat. Revive 1 Kvadrat. Remix 3 Kvadrat. Coated fabric Valencia Spradling.

## Frame Base



## Shell



Available also in one colour version (please check section "Finishes").

## Armrest



# Catifa 46 Counter Stool

Design by Lievore Altherr Molina, 2004

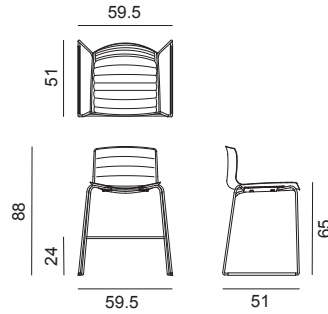

Stool with chromed or powdercoated steel sled base and shell upholstered in leather, coated fabric, fabric or customer's own material. Line detail stitching. Seat height 65 cm. Optional glides with felt for wooden floors are available upon request.

Accessories:  
Stacking protection pad Art. 0499  
Trolley Art. 0760

## Stackability:

(should the weight exceed 25 kilos a handling tool must be used).

- with stacking pad, without tools up to 8 units
- with stacking pad, with trolley up to 8 units

- leather / coated fabric: with stacking pad, without tools up to 5 units
- leather / coated fabric: with stacking pad, with trolley up to 5 units

SEK ART. 0486	A	B COM	C COL	D	E	F	G	H	I	J	K	L	M	ES
CHROMED / POWDERCOATED	5989	6299	6609	6919	7229	7539	7849	8159	8469	8779	9089	9399	9709	10870

SHIPMENT DETAILS	TECHNICAL SPECIFICATIONS	RESISTANCE TEST
<b>Art.0486</b> 1 pz = 2  - kg 11,8/ m³ 0,305 4 pz = 2  - kg 40,1/ m³ 0,412 	<b>Art.0486</b> COL requirement m² 1.67 H 140 cm. COM Meterage m 0.99 *Classe 1, 2, 11M: fire retardant version available with surcharge and eventual minimum batch	• TUV GS (EN16139)
<b>FIRE RETARDANT TEST</b> Classe 11M Omologazione Italia Divina MD Kvadrat. Divina Melange 3 Kvadrat. Divina 3 Kvadrat. Field Kvadrat. Coated fabric Valencia Spradling. • FIRE RETARDANT VERSION WITH SURCHARGE * Classe 11M Omologazione Italia Elmosoft. Revive 1 Kvadrat. Steelcut Trio 3 Kvadrat.		

## Frame Base



# Catifa 46 Bar Stool

Design by Lievore Altherr Molina, 2004

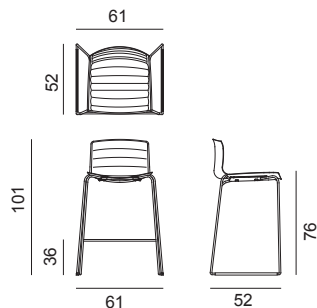

Stool with chromed or powdercoated steel sled base and shell upholstered in leather, coated fabric, fabric or customer's own material. Line detail stitching. Seat height 76 cm. Optional glides with felt for wooden floors are available upon request.

Accessories:  
Stacking protection pad Art. 0499  
Trolley Art. 0760

### Stackability:

(should the weight exceed 25 kilos a handling tool must be used).

- with stacking pad, without tools up to 8 units
- with stacking pad, with trolley up to 8 units

- leather / coated fabric: with stacking pad, without tools up to 5 units
- leather / coated fabric: with stacking pad, with trolley up to 5 units

SEK ART. 0483	A	B COM	C COL	D	E	F	G	H	I	J	K	L	M	ES
CHROMED / POWDERCOATED	5989	6299	6609	6919	7229	7539	7849	8159	8469	8779	9089	9399	9709	10870

SHIPMENT DETAILS	TECHNICAL SPECIFICATIONS	RESISTANCE TEST
<b>Art.0483</b> 1 pz = 2  - kg 12,2/ m³ 0,338 4 pz = 2  - kg 41,5/ m³ 0,448 	<b>Art.0483</b> COL requirement m² 1.67 H 140 cm. COM Meterage m 0.99 *Classe 1, 2, 1IM: fire retardant version available with surcharge and eventual minimum batch	• TUV GS (EN16139)
<b>FIRE RETARDANT TEST</b> Classe 1IM Omologazione Italia Divina MD Kvadrat. Divina Melange 3 Kvadrat. Divina 3 Kvadrat. Field Kvadrat. Coated fabric Valencia Spradling. • FIRE RETARDANT VERSION WITH SURCHARGE * Classe 1IM Omologazione Italia Elmosoft. Revive 1 Kvadrat. Steelcut Trio 3 Kvadrat.		

### Frame Base



Stackable



Standard: polycarbonate glide with polyurethane insert.



Upon request: polycarbonate glide with felt insert.





# Catifa 46 Counter Stool

Design by Lievore Altherr Molina, 2004

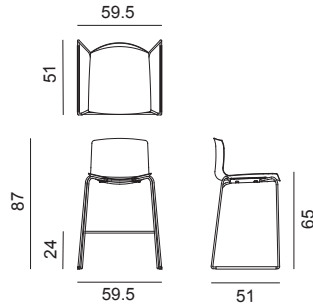

Stool with chromed or powdercoated steel sled base and polypropylene shell covered in hard leather without padding. Seat height 65 cm. Optional glides with felt for wooden floors are available upon request.

Accessories:  
Stacking protection pad Art. 0262  
Trolley Art. 0760

Stackability:  
(should the weight exceed 25 kilos a handling tool must be used).  
– CT: with stacking pad, without tools up to 5 units  
– CT: with stacking pad, with trolley up to 5 units

<b>SEK ART. 0484</b>	CT	
CHROMED / POWDERCOATED	6417	
<b>SHIPMENT DETAILS</b>	<b>TECHNICAL SPECIFICATIONS</b>	<b>RESISTANCE TEST</b>
<b>Art.0484</b> 1 pz = 2  - kg 11,8/ m³ 0,305 4 pz = 2  - kg 40,1/ m³ 0,384 		<ul style="list-style-type: none"> <li>TUV GS (EN16139)</li> </ul>
<b>FIRE RETARDANT TEST</b>		

Frame Base



Stackable



Standard: polycarbonate glide with polyurethane insert.



Upon request: polycarbonate glide with felt insert.



# Catifa 46 Bar Stool

Design by Lievore Altherr Molina, 2004

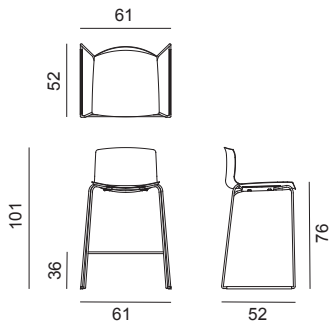

Stool with chromed or powdercoated steel sled base and polypropylene shell covered in hard leather without padding. Seat height 76 cm. Optional glides with felt for wooden floors are available upon request.

Accessories:  
Stacking protection pad Art. 0262  
Trolley Art. 0760

### Stackability:

(should the weight exceed 25 kilos a handling tool must be used).

- CT: with stacking pad, without tools up to 5 units
- CT: with stacking pad, with trolley up to 5 units

<b>SEK ART. 0481</b>	CT	
CHROMED / POWDERCOATED	6417	
<b>SHIPMENT DETAILS</b>	<b>TECHNICAL SPECIFICATIONS</b>	<b>RESISTANCE TEST</b>
<b>Art.0481</b> 1 pz = 2  - kg 12,2/ m³ 0,338 4 pz = 2  - kg 41,5/ m³ 0,448 		<ul style="list-style-type: none"> <li>• TUV GS (EN16139)</li> </ul>
<b>FIRE RETARDANT TEST</b>		

### Frame Base



Stackable



Standard: polycarbonate glide with polyurethane insert.



Upon request: polycarbonate glide with felt insert.



# Catifa 46 Counter Stool

Design by Lievore Altherr Molina, 2004

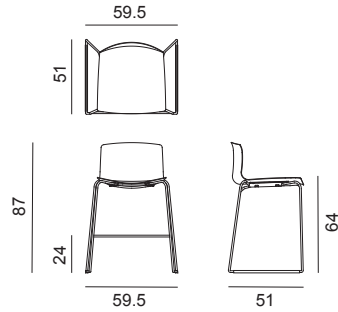

Stool with chromed or powder-coated steel sled base and oak-effect reconstituted veneer shell available in three finishes (natural oak, bleached oak, wengé). Seat height 64 cm. Optional glides with felt for wooden floors are available upon request.

Accessories:  
Cushion Art. 0261  
Stacking protection glide Art. 0286  
Trolley Art. 0760

Stackability:  
(should the weight exceed 25 kilos a handling tool must be used).  
– with stacking pad, without tools up to 10 units  
– with stacking pad, with trolley up to 10 units

<b>SEK ART. 0572</b>	<b>WOOD</b>	
CHROMED / POWDERCOATED	6394	
<b>SHIPMENT DETAILS</b>	<b>TECHNICAL SPECIFICATIONS</b>	<b>RESISTANCE TEST</b>
<b>Art.0572</b> 1 pz = 2  - kg 10,5/ m³ 0,314 4 pz = 2  - kg 34,42/ m³ 0,408 	<b>Art.0572</b> *Classe 1, 2, 11M: fire retardant version available with surcharge and eventual minimum batch	<ul style="list-style-type: none"> <li>TUV GS (EN16139)</li> </ul>
<b>FIRE RETARDANT TEST</b>		
* FIRE RETARDANT VERSION WITH SURCHARGE * Classe 1 Omologazione Italia Legno.		

## Frame Base



## Shell

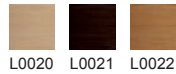

# Catifa 46 Bar Stool

Design by Lievore Altherr Molina, 2004

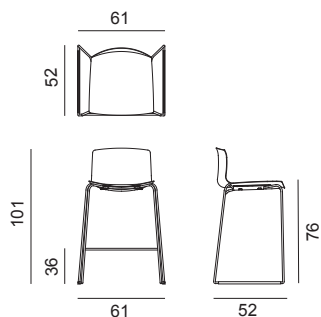

Stool with chromed or powder-coated steel sled base and oak-effect reconstituted veneer shell available in three finishes (natural oak, bleached oak, wengé). Seat height 76 cm. Optional glides with felt for wooden floors are available upon request.

Accessories:  
Cushion Art. 0261  
Stacking protection glide Art. 0286  
Trolley Art. 0760

Stackability:  
(should the weight exceed 25 kilos a handling tool must be used).  
– with stacking pad, without tools up to 10 units  
– with stacking pad, with trolley up to 10 units

<b>SEK ART. 0571</b>	<b>WOOD</b>	
CHROMED / POWDERCOATED	6394	
<b>SHIPMENT DETAILS</b>	<b>TECHNICAL SPECIFICATIONS</b>	<b>RESISTANCE TEST</b>
<b>Art.0571</b> 1 pz = 2  - kg 10,9/ m³ 0,347 4 pz = 2  - kg 35,82/ m³ 0,444 	<b>Art.0571</b> *Classe 1, 2, 11M: fire retardant version available with surcharge and eventual minimum batch	<ul style="list-style-type: none"> <li>TUV GS (EN16139)</li> </ul>
<b>FIRE RETARDANT TEST</b>		
• FIRE RETARDANT VERSION WITH SURCHARGE * Classe 1 Omologazione Italia Legno.		

## Frame Base



## Shell

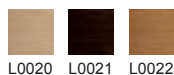

Stackable



Standard: polycarbonate glide with polyurethane insert.



Upon request: polycarbonate glide with felt insert.



# Catifa 46 Counter Stool

Design by Lievore Altherr Molina, 2004

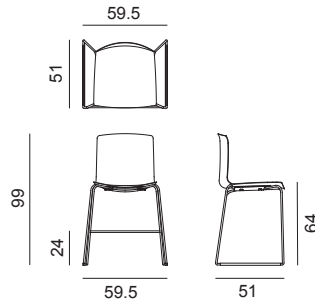

Stool with chromed or powdercoated steel sled base and shell in single-colour polypropylene or bi-colour polypropylene. Seat height 64 cm. Optional glides with felt for wooden floors are available upon request.

Accessories:  
Cushion Art. 0261  
Removable cover Art. 0309  
Trolley Art. 0760

Stackability:  
(should the weight exceed 25 kilos a handling tool must be used).  
– without tools up to 10 units  
– with trolley up to 10 units

SEK ART. 0474	PO bi-color	PO single-color	
CHROMED / POWDERCOATED	3274	3012	
Hole on shell hole to allow water drainage (only for PO)	+ 143		
Outdoor powdercoated	+ 607		
Polypropylene fire retardant (only for PO)	+ 357 (For finishes: PO00101/109/112; for other colors qty min. 300 pcs)		
SHIPMENT DETAILS	TECHNICAL SPECIFICATIONS		RESISTANCE TEST
<b>Art.0474</b> 1 pz = 2  - kg 11,3/ m³ 0,316 4 pz = 2  - kg 37,6/ m³ 0,396 	<b>Art.0474</b> Outdoor: only for PO, V12, V39 Outdoor powdercoated *Classe 1, 2, 11M: fire retardant version available with surcharge and eventual minimum batch		• TUV GS (EN16139)
<b>FIRE RETARDANT TEST</b> Classe 1 Omologazione Italia Polipropilene. • M2 Polipropilene.			

## Frame Base



## Shell



Available also in one colour version (please check section "Finishes").



# Catifa 46 Bar Stool

Design by Lievore Altherr Molina, 2004

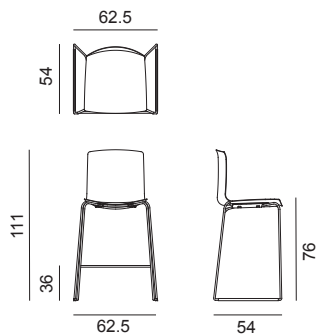

Stool with chromed or powdercoated steel sled base and shell in single-colour polypropylene or bi-colour polypropylene. Seat height 76 cm. Optional glides with felt for wooden floors are available upon request.

Accessories:  
Cushion Art. 0261  
Removable cover Art. 0309  
Trolley Art. 0760

Stackability:  
(should the weight exceed 25 kilos a handling tool must be used).  
– without tools up to 10 units  
– with trolley up to 10 units

<b>SEK ART. 0471</b>	PO bi-color	PO single-color	
CHROMED / POWDERCOATED	3274	3012	
Hole on shell hole to allow water drainage (only for PO)	+ 143		
Outdoor powdercoated	+ 607		
Polypropylene fire retardant (only for PO)	+ 357		(For finishes: PO00101/109/112; for other colors qty min. 300 pcs)
<b>SHIPMENT DETAILS</b>	<b>TECHNICAL SPECIFICATIONS</b>		<b>RESISTANCE TEST</b>
<b>Art.0471</b> 1 pz = 2  - kg 11,7/ m³ 0,349 4 pz = 2  - kg 39/ m³ 0,432 	<b>Art.0471</b> Outdoor: only for PO, V12, V39 Outdoor powdercoated *Classe 1, 2, 11M: fire retardant version available with surcharge and eventual minimum batch		<ul style="list-style-type: none"> <li>• EN 1728:2012 - EN 16139:2013 6.17</li> <li>• EN 1728:2012 - EN 16139:2013 6.4</li> <li>• EN 1728:2012 - EN 16139:2013 6.8</li> <li>• EN 1728:2012 - EN 16139:2013 6.18</li> <li>• EN 1728:2012 - EN 16139:2013 6.5</li> <li>• TUV GS (EN16139)</li> </ul>
<b>FIRE RETARDANT TEST</b> Classe 1 Omologazione Italia Polipropilene. • M2 Polipropilene.			

## Frame Base



## Shell



Available also in one colour version (please check section "Finishes").



# Catifa 46 Counter Stool

Design by Lievore Altherr Molina, 2004

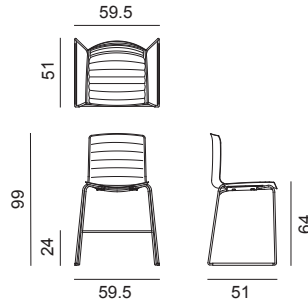

Stool with chromed or powdercoated steel sled base and polypropylene shell upholstered in leather, coated fabric, fabric or customer's own material. Line detail stitching. Seat height 64 cm. Optional glides with felt for wooden floors are available upon request.

Accessories:  
Stacking protection pad Art. 0499  
Trolley Art. 0760

## Stackability:

(should the weight exceed 25 kilos a handling tool must be used).

- with stacking pad, without tools up to 8 units
- with stacking pad, with trolley up to 8 units

- leather / coated fabric: with stacking pad, without tools up to 5 units
- leather / coated fabric: with stacking pad, with trolley up to 5 units

SEK ART. 0476	A	B COM	C COL	D	E	F	G	H	I	J	K	L	M	ES
CHROMED / POWDERCOATED	6001	6311	6621	6931	7241	7551	7861	8171	8481	8791	9101	9411	9721	10870

SHIPMENT DETAILS	TECHNICAL SPECIFICATIONS	RESISTANCE TEST
<b>Art.0476</b> 1 pz = 2  - kg 12,6/ m³ 0,338 4 pz = 2  - kg 43,6/ m³ 0,532 	<b>Art.0476</b> COL requirement m² 1.67 H 140 cm. COM Meterage m 1.1 *Classe 1, 2, 11M: fire retardant version available with surcharge and eventual minimum batch	• TUV GS (EN16139)
<b>FIRE RETARDANT TEST</b> Classe 11M Omologazione Italia Divina MD Kvadrat. Divina Melange 3 Kvadrat. Divina 3 Kvadrat. Field Kvadrat. Coated fabric Valencia Spradling. • FIRE RETARDANT VERSION WITH SURCHARGE * Classe 11M Omologazione Italia Elmosoft. Revive 1 Kvadrat. Steelcut Trio 3 Kvadrat.		

## Frame Base



# Catifa 46 Counter Stool

Design by Lievore Altherr Molina, 2013

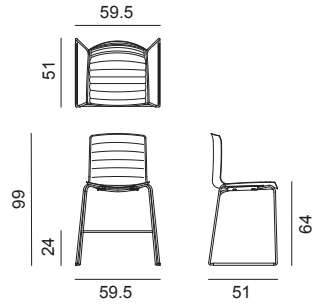

Stool with chromed or powder-coated steel sled base and white polypropylene shell (PO101) upholstered with a removable non-washable cover in leather, coated fabric, fabric or customer's own material. The cover stitching comes in the same color as the upholstery. Stitching on cover 1 and 3 comes in white or black, to customer's choice. The chair is provided already fitted with the cover. Optional glides with felt for wooden floors are available upon request. Seat height 64 cm.

Accessories:  
Stacking protection pad Art. 0499  
Trolley Art. 0760

## Stackability:

(should the weight exceed 25 kilos a handling tool must be used).

- with stacking pad, without tools up to 8 units
- with stacking pad, with trolley up to 8 units

- leather / coated fabric: with stacking pad, without tools up to 5 units
- leather / coated fabric: with stacking pad, with trolley up to 5 units

SEK ART. 0320	A	B COM	C COL	D	E	F	G	H	I	J	K	L	M	ES
CHROMED / POWDERCOATED - Cover 1	5941	6251	6561	6871	7181	7491	7801	8111	8421	8731	9041	9351	9661	10811
CHROMED / POWDERCOATED - Cover 2	6060	6370	6680	6990	7300	7610	7920	8230	8540	8850	9160	9470	9780	10943
CHROMED / POWDERCOATED - Cover 3	5941	6251	6561	6871	7181	7491	7801	8111	8421	8731	9041	9351	9661	10811
CHROMED / POWDERCOATED - Cover 4	5500	5810	6120	6430	6740	7050	7360	7670	7980	8290	8600	8910	9220	10394

SHIPMENT DETAILS	TECHNICAL SPECIFICATIONS	RESISTANCE TEST
<b>Art.0320</b> 1 pz = 2  - kg 12,6/ m³ 0,338 4 pz = 2  - kg 43,6/ m³ 0,532 	<b>Art.0320</b> COL requirement m² 1.97 H 140 cm. COM Meterage m 1.08 *Classe 1, 2, 1IM: fire retardant version available with surcharge and eventual minimum batch	• TUV GS (EN16139)

## FIRE RETARDANT TEST

Classe 1IM Omologazione Italia Divina MD Kvadrat. Divina Melange 3 Kvadrat. Divina 3 Kvadrat. Field Kvadrat. Coated fabric Valencia Spradling.  
 • FIRE RETARDANT VERSION WITH SURCHARGE \* Classe 1IM Omologazione Italia Elmosoft. Revive 1 Kvadrat. Steelcut Trio 3 Kvadrat.

## Frame Base





# Catifa 46 Bar Stool

Design by Lievore Altherr Molina, 2004

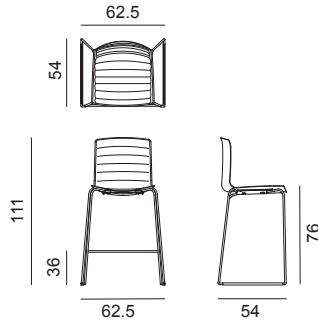

Stool with chromed or powdercoated steel sled base and polypropylene shell upholstered in leather, coated fabric, fabric or customer's own material. Line detail stitching. Seat height 76 cm. Optional glides with felt for wooden floors are available upon request.

Accessories:  
Stacking protection pad Art. 0499  
Trolley Art. 0760

Stackability:  
(should the weight exceed 25 kilos a handling tool must be used).  
– with stacking pad, without tools up to 8 units  
– with stacking pad, with trolley up to 8 units

– leather / coated fabric: with stacking pad, without tools up to 5 units  
– leather / coated fabric: with stacking pad, with trolley up to 5 units

SEK ART. 0473	A	B COM	C COL	D	E	F	G	H	I	J	K	L	M	ES
CHROMED / POWDERCOATED	6001	6311	6621	6931	7241	7551	7861	8171	8481	8791	9101	9411	9721	10870

SHIPMENT DETAILS	TECHNICAL SPECIFICATIONS	RESISTANCE TEST
<b>Art.0473</b> 1 pz = 2  - kg 13/ m² 0,371 4 pz = 2  - kg 45/ m² 0,488 	<b>Art.0473</b> COL requirement m² 1.67 H 140 cm. COM Meterage m 1.1 *Classe 1, 2, 11M: fire retardant version available with surcharge and eventual minimum batch	• TUV GS (EN16139)
<b>FIRE RETARDANT TEST</b> Classe 11M Omologazione Italia Divina MD Kvadrat. Divina Melange 3 Kvadrat. Divina 3 Kvadrat. Field Kvadrat. Coated fabric Valencia Spradling. • FIRE RETARDANT VERSION WITH SURCHARGE * Classe 11M Omologazione Italia Elmosoft. Revive 1 Kvadrat. Steelcut Trio 3 Kvadrat.		

## Frame Base



Stackable



Standard: polycarbonate glide with polyurethane insert.



Upon request: polycarbonate glide with felt insert.



# Catifa 46 Bar Stool

Design by Lievore Altherr Molina, 2013

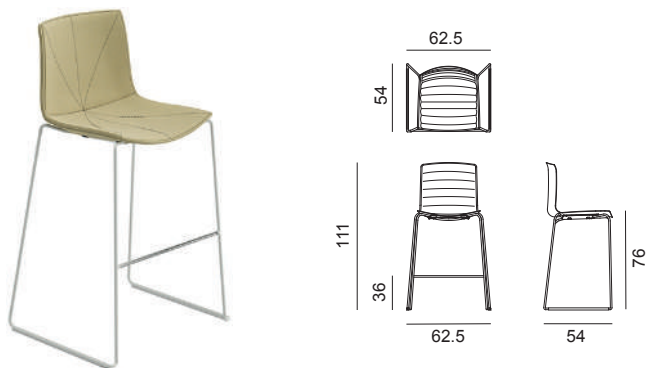

Stool with chromed or powder-coated steel sled base and polypropylene shell upholstered with a removable non-washable cover in leather, coated fabric, fabric or customer's own material. The cover stitching comes in the same color as the upholstery. Stitching on cover 1 and 3 comes in white or black, to customer's choice. The chair is provided already fitted with the cover. Optional glides with felt for wooden floors are available upon request. Seat height 76 cm.

Accessories:  
Stacking protection pad Art. 0499  
Trolley Art. 0760

### Stackability:

(should the weight exceed 25 kilos a handling tool must be used).

- with stacking pad, without tools up to 8 units
- with stacking pad, with trolley up to 8 units

- leather / coated fabric: with stacking pad, without tools up to 5 units
- leather / coated fabric: with stacking pad, with trolley up to 5 units

SEK ART. 0321	A	B COM	C COL	D	E	F	G	H	I	J	K	L	M	ES
CHROMED / POWDERCOATED - Cover 1	5941	6251	6561	6871	7181	7491	7801	8111	8421	8731	9041	9351	9661	10811
CHROMED / POWDERCOATED - Cover 2	6060	6370	6680	6990	7300	7610	7920	8230	8540	8850	9160	9470	9780	10943
CHROMED / POWDERCOATED - Cover 3	5941	6251	6561	6871	7181	7491	7801	8111	8421	8731	9041	9351	9661	10811
CHROMED / POWDERCOATED - Cover 4	5500	5810	6120	6430	6740	7050	7360	7670	7980	8290	8600	8910	9220	10394

SHIPMENT DETAILS	TECHNICAL SPECIFICATIONS	RESISTANCE TEST
<b>Art.0321</b> 1 pz = 2  - kg 13/ m³ 0,371 4 pz = 2  - kg 45/ m³ 0,488 	<b>Art.0321</b> COL requirement m² 1.97 H 140 cm. COM Meterage m 1.08 *Classe 1, 2, 1IM: fire retardant version available with surcharge and eventual minimum batch	• TUV GS (EN16139)

### FIRE RETARDANT TEST

Classe 1IM Omologazione Italia Divina MD Kvadrat. Divina Melange 3 Kvadrat. Divina 3 Kvadrat. Field Kvadrat. Coated fabric Valencia Spradling.  
 • FIRE RETARDANT VERSION WITH SURCHARGE \* Classe 1IM Omologazione Italia Elmosoft. Revive 1 Kvadrat. Steelcut Trio 3 Kvadrat.

### Frame Base



# Catifa 46 Counter Stool

Design by Lievore Altherr Molina, 2004

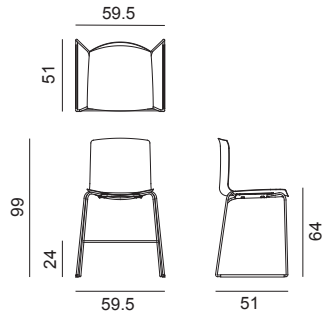

Stool with chromed or powder-coated steel sled base and polypropylene shell with front upholstery in leather, coated fabric, fabric or customer's own material. Seat height 64 cm. Optional glides with felt for wooden floors are available upon request.

Accessories:  
Stacking protection pad Art. 0499  
Trolley Art. 0760

Stackability:  
(should the weight exceed 25 kilos a handling tool must be used).  
– with stacking pad, without tools up to 8 units  
– with stacking pad, with trolley up to 8 units

– leather / coated fabric: with stacking pad, without tools up to 5 units  
– leather / coated fabric: with stacking pad, with trolley up to 5 units

SEK ART. 0477	A	B COM	C COL	D	E	F	G	H	I	J	K	L	M	ES
CHROMED / POWDERCOATED	5882	6036	6190	6344	6498	6652	6806	6960	7114	7268	7422	7576	7730	9370

SHIPMENT DETAILS	TECHNICAL SPECIFICATIONS	RESISTANCE TEST
<b>Art.0477</b> 1 pz = 2  - kg 14/ m² 0,345 4 pz = 2  - kg 45,04/ m² 0,46 (KD)	<b>Art.0477</b> COL requirement m² 0.94 H 140 cm. COM Meterage m 0.65	• TUV GS (EN16139)
<b>FIRE RETARDANT TEST</b> Classe 1IM Omologazione Italia Divina MD Kvadrat. Divina Melange 3 Kvadrat. Divina 3 Kvadrat. Elmosoft. Field Kvadrat. Hallingdal 65 Kvadrat. Revive 1 Kvadrat. Remix 3 Kvadrat. Coated fabric Valencia Spradling.		

## Frame Base



## Shell



Stackable



Standard: polycarbonate glide with polyurethane insert.



Upon request: polycarbonate glide with felt insert.



# Catifa 46 Counter Stool

Design by Lievore Altherr Molina, 2012

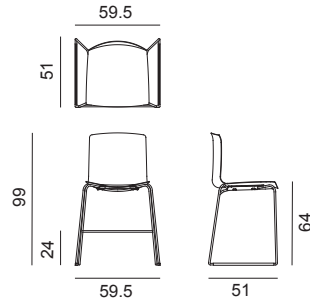

Stool with chromed or powder-coated steel sled base and Polypropylene shell with cushion upholstered in fabric, leather, coated fabric or customer's own material applied to the seat surface. Seat height 64 cm. Optional glides with felt for wooden floors are available upon request.

Accessories:  
Stacking protection pad Art. 0499  
Trolley Art. 0760

### Stackability:

(should the weight exceed 25 kilos a handling tool must be used).

- with stacking pad, without tools up to 8 units
- with stacking pad, with trolley up to 8 units

- leather / coated fabric: with stacking pad, without tools up to 5 units
- leather / coated fabric: with stacking pad, with trolley up to 5 units

SEK ART. 0304	A	B COM	C COL	D	E	F	G	H	I	J	K	L	M	ES
PO Bicolors	5239	5310	5381	5452	5523	5594	5665	5736	5807	5878	5949	6020	6091	6417
PO single-color	4977	5048	5119	5190	5261	5332	5403	5474	5545	5616	5687	5758	5829	6143

SHIPMENT DETAILS	TECHNICAL SPECIFICATIONS	RESISTANCE TEST
<b>Art.0304</b> 1 pz = 2  - kg 14/ m³ 0,345 4 pz = 2  - kg 45,04/ m³ 0,46 	<b>Art.0304</b> COL requirement m² 0,48 H 140 cm. COM Meterage m 0,59	• TUV GS (EN16139)

**FIRE RETARDANT TEST**  
 Classe 1IM Omologazione Italia Divina MD Kvadrat. Divina Melange 3 Kvadrat. Divina 3 Kvadrat. Elmosoft. Field Kvadrat. Hallingdal 65 Kvadrat. Revive 1 Kvadrat. Remix 3 Kvadrat. Coated fabric Valencia Spradling.

### Frame Base



### Shell



Available also in one colour version (please check section "Finishes").



Stackable



Standard: polycarbonate glide with polyurethane insert.



Upon request: polycarbonate glide with felt insert.



# Catifa 46 Bar Stool

Design by Lievore Altherr Molina, 2004

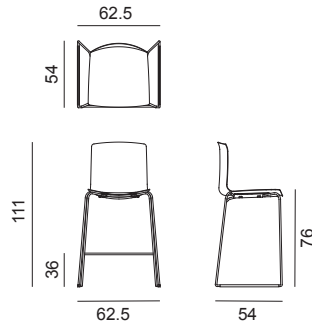

Stool with chromed or powder-coated steel sled base and polypropylene shell front upholstery in leather, coated fabric, fabric or customer's own materials. Seat height 76 cm. Optional glides with felt for wooden floors are available upon request.

Accessories:  
Stacking protection pad Art. 0499  
Trolley Art. 0760

**Stackability:**

(should the weight exceed 25 kilos a handling tool must be used).

- with stacking pad, without tools up to 8 units
- with stacking pad, with trolley up to 8 units

- leather / coated fabric: with stacking pad, without tools up to 5 units
- leather / coated fabric: with stacking pad, with trolley up to 5 units

SEK ART. 0478	A	B COM	C COL	D	E	F	G	H	I	J	K	L	M	ES
CHROMED / POWDERCOATED	5882	6036	6190	6344	6498	6652	6806	6960	7114	7268	7422	7576	7730	9370

SHIPMENT DETAILS	TECHNICAL SPECIFICATIONS	RESISTANCE TEST
<b>Art.0478</b> 1 pz = 2  - kg 14,4/ m³ 0,378 4 pz = 2  - kg 46,44/ m³ 0,496 	<b>Art.0478</b> COL requirement m² 0.94 H 140 cm. COM Meterage m 0.65	• TUV GS (EN16139)

**FIRE RETARDANT TEST**  
 Classe 1IM Omologazione Italia Divina MD Kvadrat. Divina Melange 3 Kvadrat. Divina 3 Kvadrat. Elmosoft. Field Kvadrat. Hallingdal 65 Kvadrat. Revive 1 Kvadrat. Remix 3 Kvadrat. Coated fabric Valencia Spradling.

**Frame Base**



**Shell**



# Catifa 46 Bar Stool

Design by Lievore Altherr Molina, 2012

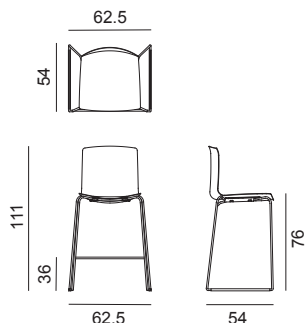

Stool with chromed or powder-coated steel sled base and Polypropylene shell with cushion upholstered in fabric, leather, coated fabric or customer's own material applied to the seat surface. Seat height 76 cm. Optional glides with felt for wooden floors are available upon request.

Accessories:  
Stacking protection pad Art. 0499  
Trolley Art. 0760

### Stackability:

(should the weight exceed 25 kilos a handling tool must be used).

- with stacking pad, without tools up to 8 units
- with stacking pad, with trolley up to 8 units

- leather / coated fabric: with stacking pad, without tools up to 5 units
- leather / coated fabric: with stacking pad, with trolley up to 5 units

SEK ART. 0305	A	B COM	C COL	D	E	F	G	H	I	J	K	L	M	ES
PO Bicolors	5239	5310	5381	5452	5523	5594	5665	5736	5807	5878	5949	6020	6091	6417
PO single-color	4977	5048	5119	5190	5261	5332	5403	5474	5545	5616	5687	5758	5829	6143

SHIPMENT DETAILS	TECHNICAL SPECIFICATIONS	RESISTANCE TEST
<b>Art.0305</b> 1 pz = 2  - kg 14,4/ m³ 0,378 4 pz = 2  - kg 46,44/ m³ 0,496 	<b>Art.0305</b> COL requirement m² 0,48 H 140 cm. COM Meterage m 0,59	• TUV GS (EN16139)

**FIRE RETARDANT TEST**  
 Classe 1IM Omologazione Italia Divina MD Kvadrat. Divina Melange 3 Kvadrat. Divina 3 Kvadrat. Elmosoft. Field Kvadrat. Hallingdal 65 Kvadrat. Revive 1 Kvadrat. Remix 3 Kvadrat. Coated fabric Valencia Spradling.

### Frame Base



### Shell



Available also in one colour version (please check section "Finishes").



Stackable



Standard: polycarbonate glide with polyurethane insert.



Upon request: polycarbonate glide with felt insert.



# Catifa 46 Counter Stool

Design by Lievore Altherr Molina, 2004

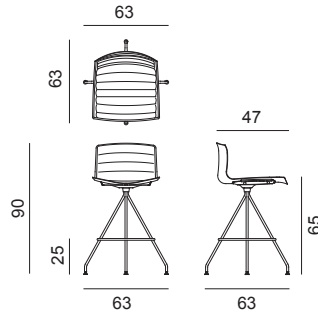

Low stool on swivelling, chromed steel base. The shell with low backrest is in polypropylene, upholstered in leather, coated fabric, fabric or customer's own material. Line detail stitching. Seat height 65 cm. Backrest height 90 cm.

Accessories:  
Set of glides Art. 2015

SEK ART. 0496	A	B COM	C COL	D	E	F	G	H	I	J	K	L	M	ES
SWIVEL BASE	8192	8502	8812	9122	9432	9742	10052	10362	10672	10982	11292	11602	11912	13073
<b>SHIPMENT DETAILS</b>	<b>TECHNICAL SPECIFICATIONS</b>				<b>RESISTANCE TEST</b>									
<b>Art.0496</b> 1 pz = 2  - kg 13,76/ m <sup>2</sup> 0,228 4 pz = 5  - kg 52,74/ m <sup>2</sup> 0,724 KD	<b>Art.0496</b> COL requirement m <sup>2</sup> 1.67 H 140 cm. COM Meterage m 0.99 *Classe 1, 2, 1IM: fire retardant version available with surcharge and eventual minimum batch				• TUV GS (EN16139)									
<b>FIRE RETARDANT TEST</b> Classe 1IM Omologazione Italia Divina MD Kvadrat. Divina Melange 3 Kvadrat. Divina 3 Kvadrat. Field Kvadrat. Coated fabric Valencia Spradling. • FIRE RETARDANT VERSION WITH SURCHARGE * Classe 1IM Omologazione Italia Elmosoft. Revive 1 Kvadrat. Steelcut Trio 3 Kvadrat.														

Frame Base

CRO



# Catifa 46 Bar Stool

Design by Lievore Altherr Molina, 2004

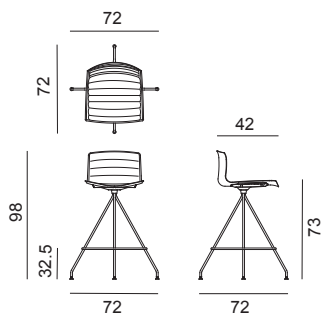

High stool on swivelling, chromed steel base. The shell with low backrest is in polypropylene, upholstered in leather, coated fabric, fabric or customer's own material. Line detail stitching. Seat height 73 cm. Backrest height 98 cm.

Accessories:  
Set of glides Art. 2015

SEK ART. 0495	A	B COM	C COL	D	E	F	G	H	I	J	K	L	M	ES
SWIVEL BASE	8192	8502	8812	9122	9432	9742	10052	10362	10672	10982	11292	11602	11912	13073
<b>SHIPMENT DETAILS</b>	<b>TECHNICAL SPECIFICATIONS</b>				<b>RESISTANCE TEST</b>									
<b>Art.0495</b> 1 pz = 2  - kg 13,96/ m³ 0,288 4 pz = 5  - kg 53,54/ m³ 0,964 	<b>Art.0495</b> COL requirement m² 1.67 H 140 cm. COM Meterage m 0.99 *Classe 1, 2, 1IM: fire retardant version available with surcharge and eventual minimum batch				<ul style="list-style-type: none"> <li>EN 1728:2012 - EN 16139:2013 6.21</li> <li>TUV GS (EN16139)</li> </ul>					<ul style="list-style-type: none"> <li>EN 1728:2012 - EN 16139:2013 6.8</li> </ul>				
<b>FIRE RETARDANT TEST</b> Classe 1IM Omologazione Italia Divina MD Kvadrat. Divina Melange 3 Kvadrat. Divina 3 Kvadrat. Field Kvadrat. Coated fabric Valencia Spradling. • FIRE RETARDANT VERSION WITH SURCHARGE * Classe 1IM Omologazione Italia Elmosoft. Revive 1 Kvadrat. Steelcut Trio 3 Kvadrat.														

Frame Base

CRO





# Catifa 46 Counter Stool

Design by Lievore Altherr Molina, 2004

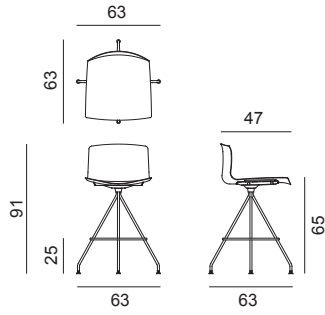

Low stool on swivelling, chromed steel base. The shell with low backrest is in polypropylene, covered in hard leather without padding. Seat height 65 cm. Backrest height 91 cm.

Accessories:  
Cushion Art. 0261  
Set of glides Art. 2015

<b>SEK ART. 0490</b>	CT	
SWIVEL BASE	8620	
<b>SHIPMENT DETAILS</b>	<b>TECHNICAL SPECIFICATIONS</b>	<b>RESISTANCE TEST</b>
<b>Art.0490</b> 1 pz = 2  - kg 13,76/ m³ 0,228 4 pz = 5  - kg 52,74/ m³ 0,696 		<ul style="list-style-type: none"> <li>TUV GS (EN16139)</li> </ul>
<b>FIRE RETARDANT TEST</b>		

Frame Base



# Catifa 46 Bar Stool

Design by Lievore Altherr Molina, 2004

High stool on swivelling, chromed steel base. The shell with low backrest is in polypropylene, covered in hard leather without padding. Seat height 73 cm. Backrest height 98 cm.

Accessories:  
Cushion Art. 0261  
Set of glides Art. 2015

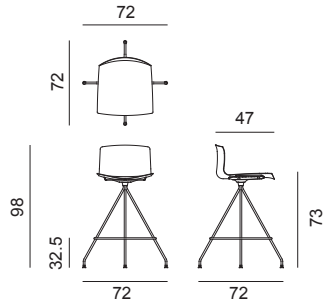

<b>SEK ART. 0489</b>	CT	
SWIVEL BASE	8620	
<b>SHIPMENT DETAILS</b>	<b>TECHNICAL SPECIFICATIONS</b>	<b>RESISTANCE TEST</b>
<b>Art.0489</b> 1 pz = 2  - kg 13,96/ m³ 0,288 4 pz = 5  - kg 53,54/ m³ 0,936 		<ul style="list-style-type: none"> <li>• EN 1728:2012 - EN 16139:2013 6.21</li> <li>• TUV GS (EN16139)</li> <li>• EN 1728:2012 - EN 16139:2013 6.8</li> </ul>
<b>FIRE RETARDANT TEST</b>		

Frame Base



# Catifa 46 Counter Stool

Design by Lievore Altherr Molina, 2004

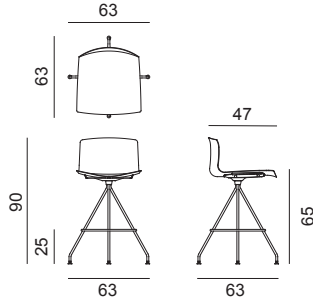

Low stool on swivelling, chromed steel base. Low backrest oak-effect reconstituted veneer shell available in three finishes (natural oak, bleached oak, wengé). Seat height 65 cm. Backrest height 90 cm.

Accessories:  
Cushion Art. 0261  
Set of glides Art. 2015

<b>SEK ART. 0492</b>	WOOD	
SWIVEL BASE	8597	
<b>SHIPMENT DETAILS</b>	<b>TECHNICAL SPECIFICATIONS</b>	<b>RESISTANCE TEST</b>
<b>Art.0492</b> 1 pz = 2  - kg 12,46/ m³ 0,237 4 pz = 5  - kg 47,06/ m³ 0,72 	<b>Art.0492</b> *Classe 1, 2, 11M: fire retardant version available with surcharge and eventual minimum batch	<ul style="list-style-type: none"> <li>TUV GS (EN16139)</li> </ul>
<b>FIRE RETARDANT TEST</b>		
* FIRE RETARDANT VERSION WITH SURCHARGE * Classe 1 Omologazione Italia Legno.		

Frame Base

CRO



Shell

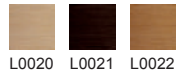

# Catifa 46 Bar Stool

Design by Lievore Altherr Molina, 2004

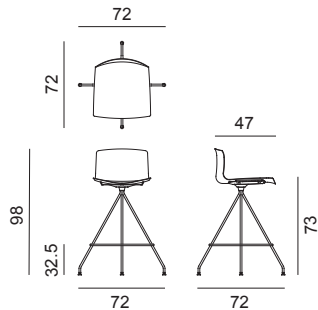

High stool on swivelling, chromed steel base. Low backrest oak-effect reconstituted veneer shell available in three finishes (natural oak, bleached oak, wengé). Seat height 73 cm. Backrest height 98 cm.

Accessories:  
Cushion Art. 0261  
Set of glides Art. 2015

<b>SEK ART. 0491</b>	WOOD	
SWIVEL BASE	8597	
<b>SHIPMENT DETAILS</b>	<b>TECHNICAL SPECIFICATIONS</b>	<b>RESISTANCE TEST</b>
<b>Art.0491</b> 1 pz = 2  - kg 12,66/ m³ 0,297 4 pz = 5  - kg 47,86/ m³ 0,96 	<b>Art.0491</b> *Classe 1, 2, 11M: fire retardant version available with surcharge and eventual minimum batch	<ul style="list-style-type: none"> <li>TUV GS (EN16139)</li> </ul>
<b>FIRE RETARDANT TEST</b>		
• FIRE RETARDANT VERSION WITH SURCHARGE * Classe 1 Omologazione Italia Legno.		

Frame Base

CRO



Shell

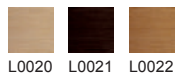

# Catifa 46 Counter Stool

Design by Lievore Altherr Molina, 2004

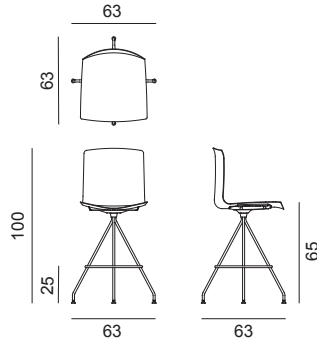

Low stool on swivelling, chromed steel base. The shell with high backrest is in single-colour polypropylene or bi-colour polypropylene. Seat height 65 cm. Backrest height 100 cm.

Accessories:  
Cushion Art. 0261  
Removable cover Art. 0309  
Set of glides Art. 2015

<b>SEK ART. 0488</b>	PO bi-color	PO single-color	
SWIVEL BASE	5477	5215	
Polypropylene fire retardant (only for PO)	+ 357	(For finishes: PO00101/109/112; for other colors qty min. 300 pcs)	
<b>SHIPMENT DETAILS</b>	<b>TECHNICAL SPECIFICATIONS</b>		<b>RESISTANCE TEST</b>
<b>Art.0488</b> 1 pz = 2  - kg 13,26/ m <sup>2</sup> 0,239 4 pz = 5  - kg 50,24/ m <sup>2</sup> 0,708 	<b>Art.0488</b> *Classe 1, 2, 11M: fire retardant version available with surcharge and eventual minimum batch		<ul style="list-style-type: none"> <li>TUV GS (EN16139)</li> </ul>
<b>FIRE RETARDANT TEST</b>			
Classe 1 Omologazione Italia Polipropilene. • M2 Polipropilene.			

Frame Base

CRO



Shell



Available also in one colour version (please check section "Finishes" ).



# Catifa 46 Bar Stool

Design by Lievore Altherr Molina, 2004

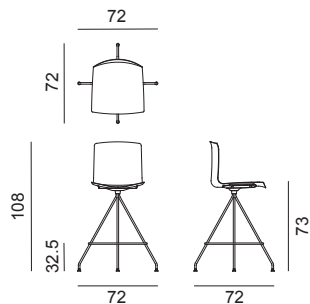

High stool on swivelling, chromed steel base. The shell with high backrest is in single-colour polypropylene or bi-colour polypropylene. Seat height 73 cm. Backrest height 108 cm.

Accessories:  
Cushion Art. 0261  
Removable cover Art. 0309  
Set of glides Art. 2015

<b>SEK ART. 0487</b>	PO bi-color	PO single-color	
SWIVEL BASE	5477	5215	
Polypropylene fire retardant (only for PO)	+ 357 (For finishes: PO00101/109/112; for other colors qty min. 300 pcs)		
<b>SHIPMENT DETAILS</b>	<b>TECHNICAL SPECIFICATIONS</b>		<b>RESISTANCE TEST</b>
<b>Art.0487</b> 1 pz = 2  - kg 13,46/ m³ 0,402 4 pz = 5  - kg 51,04/ m³ 1,081 	<b>Art.0487</b> *Classe 1, 2, 11M: fire retardant version available with surcharge and eventual minimum batch		<ul style="list-style-type: none"> <li>• EN 1728:2012 - EN 16139:2013 6.17</li> <li>• EN 1728:2012 - EN 16139:2013 6.21</li> <li>• EN 1728:2012 - EN 16139:2013 6.4</li> <li>• EN 1728:2012 - EN 16139:2013 6.8</li> </ul> <ul style="list-style-type: none"> <li>• EN 1728:2012 - EN 16139:2013 6.18</li> <li>• EN 1728:2012 - EN 16139:2013 6.24</li> <li>• EN 1728:2012 - EN 16139:2013 6.5</li> <li>• TUV GS (EN16139)</li> </ul>
<b>FIRE RETARDANT TEST</b>			
Classe 1 Omologazione Italia Polipropilene. • M2 Polipropilene.			

Frame Base



CRO



Shell



Available also in one colour version (please check section "Finishes" ).



# Catifa 46 Counter Stool

Design by Lievore Altherr Molina, 2004

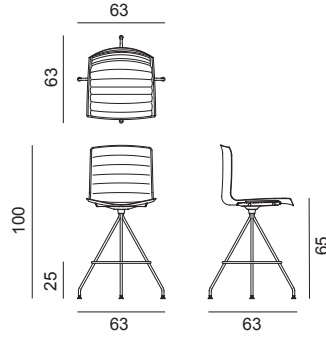

Low stool on swivelling, chromed steel base. The shell with high backrest is in polypropylene, upholstered in leather, coated fabric, fabric or customer's own material. Line detail stitching. Seat height 65 cm. Backrest height 100 cm.

Accessories:  
Set of glides Art. 2015

SEK ART. 0494	A	B COM	C COL	D	E	F	G	H	I	J	K	L	M	ES
SWIVEL BASE	8204	8514	8824	9134	9444	9754	10064	10374	10684	10994	11304	11614	11924	13073

SHIPMENT DETAILS	TECHNICAL SPECIFICATIONS	RESISTANCE TEST
<b>Art.0494</b> 1 pz = 2  - kg 14,56/ m³ 0,261 4 pz = 5  - kg 56,24/ m³ 0,764 KD	<b>Art.0494</b> COL requirement m² 1.67 H 140 cm. COM Meterage m 1.1 *Classe 1, 2, 1IM: fire retardant version available with surcharge and eventual minimum batch	• TUV GS (EN16139)
<b>FIRE RETARDANT TEST</b> Classe 1IM Omologazione Italia Divina MD Kvadrat. Divina Melange 3 Kvadrat. Divina 3 Kvadrat. Field Kvadrat. Coated fabric Valencia Spradling. • FIRE RETARDANT VERSION WITH SURCHARGE * Classe 1IM Omologazione Italia Elmosoft. Revive 1 Kvadrat. Steelcut Trio 3 Kvadrat.		

Frame Base

CRO



# Catifa 46 Counter Stool

Design by Lievore Altherr Molina, 2013

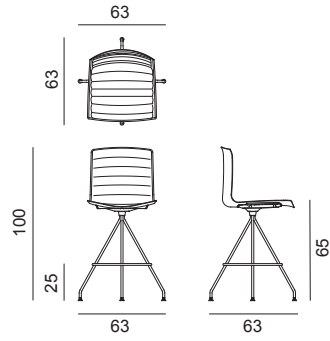

Low stool on swivelling, chromed steel base. The polypropylene shell is upholstered with a removable non-washable cover in leather, coated fabric, fabric or customer's own material. The cover stitching comes in the same color as the upholstery. Stitching on cover 1 and 3 comes in white or black, to customer's choice. The chair is provided already fitted with the cover. Seat height 65 cm. Backrest height 100 cm

Accessories:  
Set of glides Art. 2015

SEK ART. 0322	A	B COM	C COL	D	E	F	G	H	I	J	K	L	M	ES
SWIVEL BASE - Cover 1	8144	8454	8764	9074	9384	9694	10004	10314	10624	10934	11244	11554	11864	13014
SWIVEL BASE - Cover 2	8263	8573	8883	9193	9503	9813	10123	10433	10743	11053	11363	11673	11983	13146
SWIVEL BASE - Cover 3	8144	8454	8764	9074	9384	9694	10004	10314	10624	10934	11244	11554	11864	13014
SWIVEL BASE - Cover 4	7703	8013	8323	8633	8943	9253	9563	9873	10183	10493	10803	11113	11423	12597

SHIPMENT DETAILS	TECHNICAL SPECIFICATIONS	RESISTANCE TEST
<b>Art.0322</b> 1 pz = 2  - kg 14,56/ m² 0,261 4 pz = 5  - kg 56,24/ m² 0,764 KD	<b>Art.0322</b> COL requirement m² 1.97 H 140 cm. COM Meterage m 1.08 *Classe 1, 2, 1IM: fire retardant version available with surcharge and eventual minimum batch	• TUV GS (EN16139)
<b>FIRE RETARDANT TEST</b> Classe 1IM Omologazione Italia Divina MD Kvadrat. Divina Melange 3 Kvadrat. Divina 3 Kvadrat. Field Kvadrat. Coated fabric Valencia Spradling. * FIRE RETARDANT VERSION WITH SURCHARGE * Classe 1IM Omologazione Italia Elmosoft. Revive 1 Kvadrat. Steelcut Trio 3 Kvadrat.		

Frame Base



CRO





# Catifa 46 Bar Stool

Design by Lievore Altherr Molina, 2004

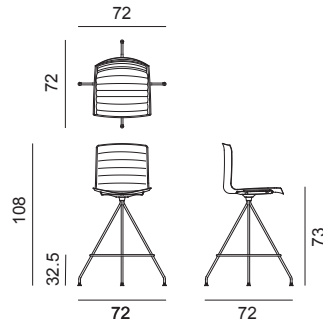

High stool on swivelling, chromed steel base. The shell with high backrest is in polypropylene, upholstered in leather, coated fabric, fabric or customer's own material. Line detail stitching. Seat height 73 cm. Backrest height 108 cm.

Accessories:  
Set of glides Art. 2015

SEK ART. 0493	A	B COM	C COL	D	E	F	G	H	I	J	K	L	M	ES
SWIVEL BASE	8204	8514	8824	9134	9444	9754	10064	10374	10684	10994	11304	11614	11924	13073
<b>SHIPMENT DETAILS</b>	<b>TECHNICAL SPECIFICATIONS</b>				<b>RESISTANCE TEST</b>									
<b>Art.0493</b> 1 pz = 2  - kg 14,76/ m³ 0,321 4 pz = 5  - kg 57,04/ m³ 1,004 KD	<b>Art.0493</b> COL requirement m² 1.67 H 140 cm. COM Meterage m 1.1 *Classe 1, 2, 1IM: fire retardant version available with surcharge and eventual minimum batch				<ul style="list-style-type: none"> <li>• EN 1728:2012 - EN 16139:2013 6.17</li> <li>• EN 1728:2012 - EN 16139:2013 6.21</li> <li>• EN 1728:2012 - EN 16139:2013 6.4</li> <li>• EN 1728:2012 - EN 16139:2013 6.8</li> </ul>					<ul style="list-style-type: none"> <li>• EN 1728:2012 - EN 16139:2013 6.18</li> <li>• EN 1728:2012 - EN 16139:2013 6.24</li> <li>• EN 1728:2012 - EN 16139:2013 6.5</li> <li>• TUV GS (EN16139)</li> </ul>				
<b>FIRE RETARDANT TEST</b> Classe 1IM Omologazione Italia Divina MD Kvadrat. Divina Melange 3 Kvadrat. Divina 3 Kvadrat. Field Kvadrat. Coated fabric Valencia Spradling. • FIRE RETARDANT VERSION WITH SURCHARGE * Classe 1IM Omologazione Italia Elmosoft. Revive 1 Kvadrat. Steelcut Trio 3 Kvadrat.														

Frame Base

CRO



# Catifa 46 Bar Stool

Design by Lievore Altherr Molina, 2013

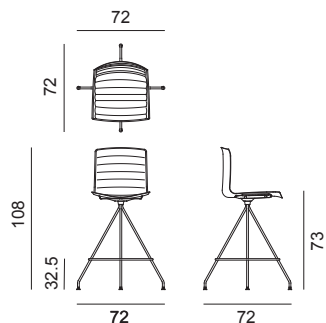

High stool on swivelling, chromed steel base. The polypropylene shell with high backrest is upholstered with a removable non-washable cover in leather, coated fabric, fabric or customer's own material. The cover stitching comes in the same color as the upholstery. Stitching on cover 1 and 3 comes in white or black, to customer's choice. The chair is provided already fitted with the cover. Seat height 73 cm. Backrest height 108 cm.

Accessories:  
Set of glides Art. 2015

SEK ART. 0323	A	B COM	C COL	D	E	F	G	H	I	J	K	L	M	ES
SWIVEL BASE - Cover 1	8144	8454	8764	9074	9384	9694	10004	10314	10624	10934	11244	11554	11864	13014
SWIVEL BASE - Cover 2	8263	8573	8883	9193	9503	9813	10123	10433	10743	11053	11363	11673	11983	13146
SWIVEL BASE - Cover 3	8144	8454	8764	9074	9384	9694	10004	10314	10624	10934	11244	11554	11864	13014
SWIVEL BASE - Cover 4	7703	8013	8323	8633	8943	9253	9563	9873	10183	10493	10803	11113	11423	12597

SHIPMENT DETAILS	TECHNICAL SPECIFICATIONS	RESISTANCE TEST
<b>Art.0323</b> 1 pz = 2  - kg 14,76/ m² 0,321 4 pz = 5  - kg 57,04/ m² 1,004 KD	<b>Art.0323</b> COL requirement m² 1.97 H 140 cm. COM Meterage m 1.08 *Classe 1, 2, 1IM: fire retardant version available with surcharge and eventual minimum batch	<ul style="list-style-type: none"> <li>• EN 1728:2012 - EN 16139:2013 6.17</li> <li>• EN 1728:2012 - EN 16139:2013 6.21</li> <li>• EN 1728:2012 - EN 16139:2013 6.4</li> <li>• EN 1728:2012 - EN 16139:2013 6.8</li> <li>• EN 1728:2012 - EN 16139:2013 6.18</li> <li>• EN 1728:2012 - EN 16139:2013 6.24</li> <li>• EN 1728:2012 - EN 16139:2013 6.5</li> <li>• TUV GS (EN16139)</li> </ul>

**FIRE RETARDANT TEST**  
 Classe 1IM Omologazione Italia Divina MD Kvadrat. Divina Melange 3 Kvadrat. Divina 3 Kvadrat. Field Kvadrat. Coated fabric Valencia Spradling.  
 • FIRE RETARDANT VERSION WITH SURCHARGE • Classe 1IM Omologazione Italia Elmosoft. Revive 1 Kvadrat. Steelcut Trio 3 Kvadrat.

Frame Base



CRO



# Catifa 46 Counter Stool

Design by Lievore Altherr Molina, 2004

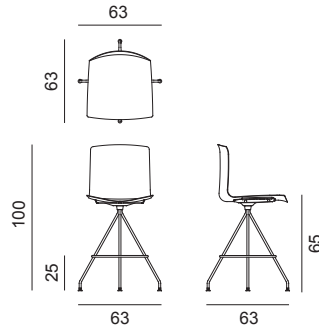

Low stool on swivelling, chromed steel base. Polypropylene shell with high backrest and front upholstery in leather, coated fabric, fabric or customer's own material. Seat height 65 cm. Backrest height 100 cm.

Accessories:  
Set of glides Art. 2015

SEK ART. 0498	A	B COM	C COL	D	E	F	G	H	I	J	K	L	M	ES
SWIVEL BASE	8085	8239	8393	8547	8701	8855	9009	9163	9317	9471	9625	9779	9933	11573

SHIPMENT DETAILS	TECHNICAL SPECIFICATIONS	RESISTANCE TEST
<b>Art.0498</b> 1 pz = 2  - kg 15,96/ m <sup>2</sup> 0,268 4 pz = 5  - kg 57,68/ m <sup>2</sup> 0,772 KD	<b>Art.0498</b> COL requirement m <sup>2</sup> 0.94 H 140 cm. COM Meterage m 0.65	• TUV GS (EN16139)

**FIRE RETARDANT TEST**  
 Classe 1IM Omologazione Italia Divina MD Kvadrat. Divina Melange 3 Kvadrat. Divina 3 Kvadrat. Elmosoft. Field Kvadrat. Hallingdal 65 Kvadrat. Revive 1 Kvadrat. Remix 3 Kvadrat. Coated fabric Valencia Spradling.

Frame Base



Shell



# Catifa 46 Counter Stool

Design by Lievore Altherr Molina, 2012

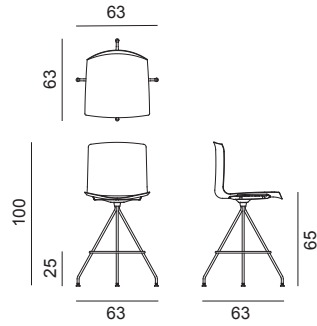

Low stool on swivelling, chromed steel base. The shell with high backrest is in polypropylene with cushion upholstered in fabric, leather, coated fabric or customer's material applied to the seat surface. Seat height 65 cm. Backrest height 100 cm.

Accessories:  
Set of glides Art. 2015

SEK ART. 0306	A	B COM	C COL	D	E	F	G	H	I	J	K	L	M	ES
SWIVEL BASE PO Bicolors	7442	7513	7584	7655	7726	7797	7868	7939	8010	8081	8152	8223	8294	8620
SWIVEL BASE PO single-color	7180	7251	7322	7393	7464	7535	7606	7677	7748	7819	7890	7961	8032	8346

SHIPMENT DETAILS	TECHNICAL SPECIFICATIONS	RESISTANCE TEST
<b>Art.0306</b> 1 pz = 2  - kg 15,96/ m³ 0,268 4 pz = 5  - kg 57,68/ m³ 0,772 	<b>Art.0306</b> COL requirement m² 0.48 H 140 cm. COM Meterage m 0.59	• TUV GS (EN16139)

**FIRE RETARDANT TEST**  
 Classe 1IM Omologazione Italia Divina MD Kvadrat. Divina Melange 3 Kvadrat. Divina 3 Kvadrat. Elmosoft. Field Kvadrat. Hallingdal 65 Kvadrat. Revive 1 Kvadrat. Remix 3 Kvadrat. Coated fabric Valencia Spradling.

Frame Base



CRO



Shell



Available also in one colour version (please check section "Finishes").



# Catifa 46 Bar Stool

Design by Lievore Altherr Molina, 2004

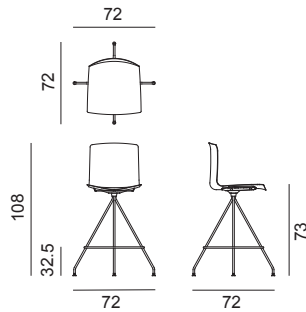

High stool on swivelling, chromed steel base. Polypropylene shell with high backrest and front upholstery in leather, coated fabric, fabric or customer's own material. Seat height 73 cm. Backrest height 108 cm.

Accessories:  
Set of glides Art. 2015

SEK ART. 0497	A	B COM	C COL	D	E	F	G	H	I	J	K	L	M	ES
SWIVEL BASE	8085	8239	8393	8547	8701	8855	9009	9163	9317	9471	9625	9779	9933	11573

SHIPMENT DETAILS	TECHNICAL SPECIFICATIONS	RESISTANCE TEST
<b>Art.0497</b> 1 pz = 2  - kg 16,16/ m³ 0,328 4 pz = 5  - kg 58,48/ m³ 1,012 	<b>Art.0497</b> COL requirement m² 0.94 H 140 cm. COM Meterage m 0.65	<ul style="list-style-type: none"> <li>• EN 1728:2012 - EN 16139:2013 6.17</li> <li>• EN 1728:2012 - EN 16139:2013 6.21</li> <li>• EN 1728:2012 - EN 16139:2013 6.4</li> <li>• EN 1728:2012 - EN 16139:2013 6.8</li> </ul> <ul style="list-style-type: none"> <li>• EN 1728:2012 - EN 16139:2013 6.18</li> <li>• EN 1728:2012 - EN 16139:2013 6.24</li> <li>• EN 1728:2012 - EN 16139:2013 6.5</li> <li>• TUV GS (EN16139)</li> </ul>

**FIRE RETARDANT TEST**  
 Classe 1IM Omologazione Italia Divina MD Kvadrat. Divina Melange 3 Kvadrat. Divina 3 Kvadrat. Elmosoft. Field Kvadrat. Hallingdal 65 Kvadrat. Revive 1 Kvadrat. Remix 3 Kvadrat. Coated fabric Valencia Spradling.

Frame Base



Shell



# Catifa 46 Bar Stool

Design by Lievore Altherr Molina, 2012

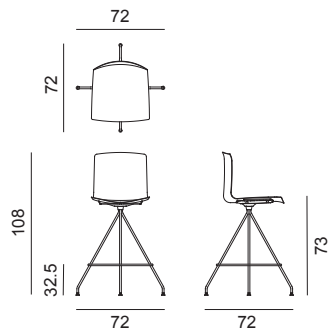

High stool on swivelling, chromed steel base. The shell with high backrest is in polypropylene with cushion upholstered in fabric, leather, coated fabric or customer's material applied to the seat surface. Seat height 73 cm. Backrest height 108 cm.

Accessories:  
Set of glides Art. 2015

SEK ART. 0307	A	B COM	C COL	D	E	F	G	H	I	J	K	L	M	ES
SWIVEL BASE PO Bicolors	7442	7513	7584	7655	7726	7797	7868	7939	8010	8081	8152	8223	8294	8620
SWIVEL BASE PO single-color	7180	7251	7322	7393	7464	7535	7606	7677	7748	7819	7890	7961	8032	8346

SHIPMENT DETAILS	TECHNICAL SPECIFICATIONS	RESISTANCE TEST
<b>Art.0307</b> 1 pz = 2  - kg 16,16/ m³ 0,328 4 pz = 5  - kg 58,48/ m³ 1,012 	<b>Art.0307</b> COL requirement m² 0.48 H 140 cm. COM Meterage m 0.59	<ul style="list-style-type: none"> <li>• EN 1728:2012 - EN 16139:2013 6.17</li> <li>• EN 1728:2012 - EN 16139:2013 6.21</li> <li>• EN 1728:2012 - EN 16139:2013 6.4</li> <li>• EN 1728:2012 - EN 16139:2013 6.8</li> <li>• EN 1728:2012 - EN 16139:2013 6.18</li> <li>• EN 1728:2012 - EN 16139:2013 6.24</li> <li>• EN 1728:2012 - EN 16139:2013 6.5</li> <li>• TUV GS (EN16139)</li> </ul>

**FIRE RETARDANT TEST**  
 Classe 11M Omologazione Italia Divina MD Kvadrat. Divina Melange 3 Kvadrat. Divina 3 Kvadrat. Elmosoft. Field Kvadrat. Hallingdal 65 Kvadrat. Revive 1 Kvadrat. Remix 3 Kvadrat. Coated fabric Valencia Spradling.

Frame Base



Shell

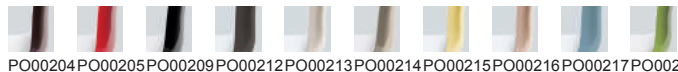

Available also in one colour version (please check section "Finishes").



## Accessories

Design by Lievore Altherr Molina, 2013

Fabric, leather, coated fabric or customer's own material, non-washable, removable covers are available in the following four versions: cross-shaped stitching (Cover 1), line stitching (Cover 2), star-shaped stitching (Cover 3), or without stitching (Cover 4). Stitching on cover 1 and 3 comes in white or black, to customer's choice. Stitching on cover 2 and 4 comes in in the same color as the upholstery. Covers to be sold separately from shell.



Cover 1 - Cross-shaped stitching



Cover 2 - Line stitching



Cover 3 - Star-shaped stitching



Cover 4 - Without stitching

<b>SEK ART. 0309</b>	A	B COM	C COL	D	E	F	G	H	I	J	K	L	M	ES
Cover 1 - Cross-shaped stitching	3251	3561	3871	4181	4491	4801	5111	5421	5731	6041	6351	6661	6971	8121
Cover 2 - Line stitching	3370	3680	3990	4300	4610	4920	5230	5540	5850	6160	6470	6780	7090	8239
Cover 3 - Star-shaped stitching	3251	3561	3871	4181	4491	4801	5111	5421	5731	6041	6351	6661	6971	8121
Cover 4 - Without stitching	2798	3108	3418	3728	4038	4348	4658	4968	5278	5588	5898	6208	6518	7692

SHIPMENT DETAILS	TECHNICAL SPECIFICATIONS	RESISTANCE TEST
<b>Art. 0309</b> 1 pz = 1  - kg 5/ m³ 0,138 10 pz = 1  - kg 11,06/ m³ 0,155 20 pz = 1  - kg 22,06/ m³ 0,262 4 pz = 1  - kg 10/ m³ 0,138	<b>Art.0309</b> COL requirement m² 1.97 H 140 cm. COM Meterage m 1.08	
<b>FIRE RETARDANT TEST</b> Classe 1IM Omologazione Italia Divina MD Kvadrat. Divina Melange 3 Kvadrat. Divina 3 Kvadrat. Coated fabric Valencia Spradling.		





## Accessories

Design by Lievore Altherr Molina, 2009

Cushion equipped with two velcro strips on the underside to fix it to the seat. Polyurethane foam padding, upholstered in fabric, leather or coated fabric.













SEK ART. 0261	A	B COM	C COL	D	E	F	G	H	I	J	K	L	M	ES
SEAT CUSHION	1274	1488	1702	1916	2130	2344	2558	2772	2986	3200	3414	3628	3842	4227
<b>SHIPMENT DETAILS</b>	<b>TECHNICAL SPECIFICATIONS</b>				<b>RESISTANCE TEST</b>									
<b>Art.0261</b> 1 pz = 1  - kg 1,2/ m² 0,023 4 pz = 1  - kg 2,9/ m² 0,072	<b>Art.0261</b> COL requirement m² 0.54 H 140 cm. COM Meterage m 0.61													
<b>FIRE RETARDANT TEST</b>														
Classe 1IM Omologazione Italia Divina MD Kvadrat. Divina Melange 3 Kvadrat. Divina 3 Kvadrat. Coated fabric Valencia Spradling.														

























# Accessories

Design by Lievore Altherr Molina

<p><b>SEK ART. 0258</b></p>  <p>Link</p>	<p><b>SEK ART. 0260</b></p>  <p>Stacking protection pad for chair with link (link is not included). For CT.</p>	<p><b>SEK ART. 0262</b></p>  <p>Stacking protection pad. For CT.</p>	<p><b>SEK ART. 0264</b></p>  <p>Writing tablet in HPL anthracite. 25,5 x 26,6 cm</p>	<p><b>SEK ART. 0277</b></p>  <p>Stacking protection pad for chair with link (only version without armrest pad). For upholstered shell.</p>
512	786	727	1583	703
<p><b>SEK ART. 0286</b></p>  <p>Stacking protection glide for wooden shell.</p>	<p><b>SEK ART. 0499</b></p>  <p>Stacking protection pad. For upholstered shell.</p>	<p><b>SEK ART. 0500</b></p>  <p>Trolley (Aava 02, Catifa 46, Catifa 53, Juno 02, Mixu)</p>	<p><b>SEK ART. 0760</b></p>  <p>Trolley (finishes V03)</p>	<p><b>SEK ART. 2015</b></p>  <p>Set of glides (white or black) in felt</p>
286	393	4549	1560	202
<p><b>SEK ART. 2073</b></p>  <p>Movable link (not suitable for chairs with armrests)</p>				
48				

SHIPMENT DETAILS	TECHNICAL SPECIFICATIONS	RESISTANCE TEST
<p><b>Art. 0258</b> 1 pz = 1  - kg 0,73/ m³ 0,006</p> <p><b>Art. 0260</b> 1 pz = 1  - kg 1,14/ m³ 0,037 4 pz = 1  - kg 3/ m³ 0,037</p> <p><b>Art. 0262</b> 1 pz = 1  - kg 1,02/ m³ 0,029 4 pz = 1  - kg 2,66/ m³ 0,036</p> <p><b>Art. 0264</b> 1 pz = 1  - kg 8,5/ m³ 0,005 4 pz = 1  - kg 32,5/ m³ 0,015</p> <p><b>Art. 0277</b> 1 pz = 2  - kg 1,75/ m³ 0,037 4 pz = 2  - kg 5,58/ m³ 0,037</p> <p><b>Art. 0286</b> 1 pz = 1  - kg 0,1/ m³ 0,001 4 pz = 1  - kg 0,68/ m³ 0,01</p> <p><b>Art. 0499</b> 1 pz = 1  - kg 1,02/ m³ 0,037 4 pz = 1  - kg 2,66/ m³ 0,037</p> <p><b>Art. 2015</b> 1 pz = 1  - kg 0,08/ m³ 0,001 10 pz = 1  - kg 1,2/ m³ 0,007</p> <p><b>Art. 2073</b> 1 pz = 1  - kg 1,5/ m³ 0,012 10 pz = 1  - kg 1,5/ m³ 0,012 2 pz = 1  - kg 1,5/ m³ 0,012 4 pz = 1  - kg 1,5/ m³ 0,012</p>		<p>• EN 14703:2007 7.3</p> <p>• EN 14703:2007 7.2</p>
<p><b>FIRE RETARDANT TEST</b></p> 		

# CATIFA 53

---

Design by  
Lievore Altherr Molina  
2001



# Catifa 53

## Collection overview

---

### Bases



4 legs  
Armrest versions



4 wood legs



Sled  
Armrest versions



Aluminum trestle  
swivel base  
Armrest versions



Aluminum trestle  
fixed base  
Armrest versions



5 aluminium ways  
Armrest versions



Bench

---

# Catifa 53

## Shells

### Polypropylene



Monocolour

Frontal upholstered

### Upholstered



Upholstered with non-removable cover

Upholstered with a removable cover. Available with 4 different stitchings.

Upholstered in hard leather.

## Armrest types



BV =  
Brushed stainless structure steel

CV =  
Polypropylene pad

CI =  
Upholstered pad

For further accessories please go at the end of the collection



Outdoor options:  
available for polypropylene shells and the follow bases:  
— 4 legs  
— Sled

# Catifa 53

Design by Lievore Altherr Molina, 2001

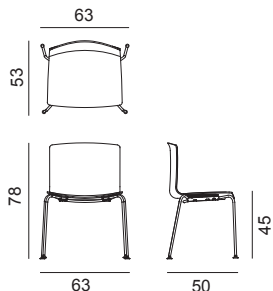

Chair with four-leg frame, available in chromed or powdercoated steel. The shell is available in polypropylene matt single-color or covered in hard leather without padding. Models with polypropylene shell and powder-coated base can be used outdoor. Polypropylene or steel armrests, are available upon request.

- Accessories:
- Stacking protection pad Art. 0228
  - Cushion Art. 0230
  - Cushion Art. 0231
  - Link Art. 0258
  - Single trolley Art. 0500
  - Trolley Art. 0760
  - Stacking protection pad with link Art. 2013
  - Set of glides Art. 2015
  - Movable link Art. 2073
  - Removable cover Art. 3116

### Stackability:

(should the weight exceed 25 kilos a handling tool must be used).

- without tools up to 10 units
- with trolley up to 15 units
- with link: without tools up to 10 units
- with link: with trolley up to 12 units

- CT: with stacking pad, without tools up to 5 units
- CT: with stacking pad, with trolley up to 5 units
- CT with link: with stacking pad, without tools up to 5 units
- CT with link: with stacking pad, with trolley up to 5 units

- with arms (BV version only): without tools up to 5 units
- with arms (BV version only): with trolley up to 5 units
- with arms (BV version only) with link: without tools up to 5 units
- with arms (BV version only) with link: with trolley up to 5 units

SEK ART. 0201	CT	PO single-color	
CHROMED / POWDERCOATED	5762	2154	
Armrests BV	+ 1083		
Armrests CV - pad (only for PO)	+ 334		
Hole on shell to allow water drainage (only for PO)	+ 143		
Outdoor powdercoated	+ 500		
Polypropylene fire retardant (only for PO)	+ 441		(For all finishes qty min. 300 pcs)

SHIPMENT DETAILS	TECHNICAL SPECIFICATIONS	RESISTANCE TEST
<b>Art.0201</b> 1 pz = 2  - kg 9,5/ m³ 0,297 1 pz = 3  - kg 11,86/ m³ 0,325 4 pz = 2  - kg 26,54/ m³ 0,368 4 pz = 3  - kg 34,44/ m³ 0,404 	<b>Art.0201</b> Outdoor: only for PO, V12, V39 Outdoor powdercoated *Classe 1, 2, 1IM: fire retardant version available with surcharge and eventual minimum batch	<ul style="list-style-type: none"> <li>• EN 1728:2012 - EN 16139:2013 6.15</li> <li>• EN 1728:2012 - EN 16139:2013 6.4</li> <li>• ENV 581-2 Appendice A.3.1</li> <li>• EN 1728:2012 - EN 16139:2013 6.16</li> <li>• EN 1728:2012 - EN 16139:2013 6.5</li> </ul>

**FIRE RETARDANT TEST**  
 \* FIRE RETARDANT VERSION WITH SURCHARGE \* Classe 1 Omologazione Italia Polipropilene.

### Frame Base



### Shell



### Armrest

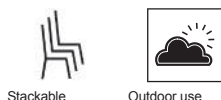

# Catifa 53

Design by Lievore Altherr Molina, 2001

Chair with four-leg steel frame, available in chromed or powdercoated version. The shell is upholstered in leather, coated fabric, fabric or customer's material. Line detail stitching. Steel armrests, also upholstered, are available upon request.

### Accessories:

- Stacking protection pad Art. 0228
- Link Art. 0258
- Single trolley Art. 0500
- Trolley Art. 0760
- Stacking protection pad with link Art. 2013
- Set of glides Art. 2015
- Movable link Art. 2073

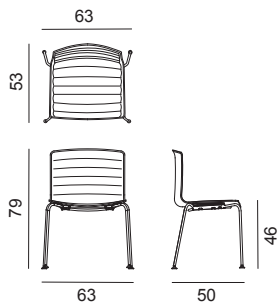

### Stackability:

(should the weight exceed 25 kilos a handling tool must be used).

- with stacking pad, without tools up to 8 units
- with stacking pad, with trolley up to 8 units
- with link: with stacking pad, without tools up to 8 units
- with link: with stacking pad, with trolley up to 8 units
- leather / coated fabric: with stacking pad, without tools up to 5 units
- leather / coated fabric: with stacking pad, with trolley up to 5 units
- leather / coated fabric with link: with stacking pad, without tools up to 5 units
- leather / coated fabric with link: with stacking pad, with trolley up to 5 units
- with arms (BV version only): with stacking pad, without tools up to 5 units
- with arms (BV version only): with stacking pad, with trolley up to 5 units
- with arms (BV version only) with link: with stacking pad, without tools up to 5 units
- with arms (BV version only) with link: with stacking pad, with trolley up to 5 units

SEK ART. 0203	A	B COM	C COL	D	E	F	G	H	I	J	K	L	M	ES
CHROMED / POWDERCOATED	5239	5585	5931	6277	6623	6969	7315	7661	8007	8353	8699	9045	9391	10501
Armrests BV	+ 1083													
Armrests CI - only pad	+ 727													

SHIPMENT DETAILS	TECHNICAL SPECIFICATIONS	RESISTANCE TEST
<b>Art.0203</b> 1 pz = 2  - kg 10,5/ m³ 0,301 1 pz = 3  - kg 12,86/ m³ 0,329 4 pz = 2  - kg 30,94/ m³ 0,408 4 pz = 3  - kg 38,84/ m³ 0,444 	<b>Art.0203</b> COL requirement m² 1,78 H 140 cm. COM Meterage m 1,21	• ENV 581-2 Appendice A.3.1

FIRE RETARDANT TEST
Classe 11M Omologazione Italia Divina MD Kvadrat. Divina Melange 3 Kvadrat. Divina 3 Kvadrat. Coated fabric Valencia Spradling.

### Frame Base



### Armrest



# Catifa 53

Design by Lievore Altherr Molina, 2013

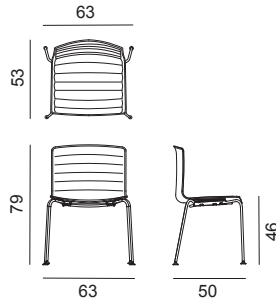

Chair with four-leg steel frame, available in chromed or powder-coated version. The white polypropylene shell is upholstered with a removable non-washable cover in leather, coated fabric, fabric or customer's own material. The cover stitching comes in the same color as the upholstery. Stitching on cover 1 and 3 comes in white or black, to customer's choice. The chair is provided already fitted with the cover. Steel armrests are available upon request.

Accessories:  
 Stacking protection pad Art. 0228  
 Link Art. 0258  
 Single trolley Art. 0500  
 Trolley Art. 0760  
 Stacking protection pad with link Art. 2013  
 Set of glides Art. 2015  
 Movable link Art. 2073  
 Stacking protection pad Art. 3115

### Stackability:

(should the weight exceed 25 kilos a handling tool must be used).

- with stacking pad, without tools up to 8 units
- with stacking pad, with trolley up to 8 units
- with link: with stacking pad, without tools up to 8 units
- with link: with stacking pad, with trolley up to 8 units
- leather / coated fabric: with stacking pad, without tools up to 5 units
- leather / coated fabric: with stacking pad, with trolley up to 5 units
- leather / coated fabric with link: with stacking pad, without tools up to 5 units
- leather / coated fabric with link: with stacking pad, with trolley up to 5 units
- with arms (BV version only): with stacking pad, without tools up to 5 units
- with arms (BV version only): with stacking pad, with trolley up to 5 units
- with arms (BV version only) with link: with stacking pad, without tools up to 5 units
- with arms (BV version only) with link: with stacking pad, with trolley up to 5 units

SEK ART. 3117	A	B COM	C COL	D	E	F	G	H	I	J	K	L	M	ES
CHROMED / POWDERCOATED - Cover 1	5024	5370	5716	6062	6408	6754	7100	7446	7792	8138	8484	8830	9176	10334
CHROMED / POWDERCOATED - Cover 2	5274	5620	5966	6312	6658	7004	7350	7696	8042	8388	8734	9080	9426	10596
CHROMED / POWDERCOATED - Cover 3	5024	5370	5716	6062	6408	6754	7100	7446	7792	8138	8484	8830	9176	10334
CHROMED / POWDERCOATED - Cover 4	4727	5073	5419	5765	6111	6457	6803	7149	7495	7841	8187	8533	8879	10049
Armrests BV	+ 1083													
SHIPMENT DETAILS	TECHNICAL SPECIFICATIONS				RESISTANCE TEST									
<b>Art.3117</b> 1 pz = 2  - kg 10,5/ m³ 0,301 1 pz = 3  - kg 12,86/ m³ 0,329 4 pz = 2  - kg 30,94/ m³ 0,408 4 pz = 3  - kg 38,84/ m³ 0,444 KD	<b>Art.3117</b> COL requirement m² 2.08 H 140 cm. COM Meterage m 1.23				• ENV 581-2 Appendice A.3.1									
FIRE RETARDANT TEST														
Classe 1IM Omologazione Italia Divina MD Kvadrat. Divina Melange 3 Kvadrat. Divina 3 Kvadrat. Coated fabric Valencia Spradling.														

### Frame Base



### Armrest



Armrests BV



Cover 1 Cover 2 Cover 3 Cover 4 Stackable



# Catifa 53

Design by Lievore Altherr Molina, 2001

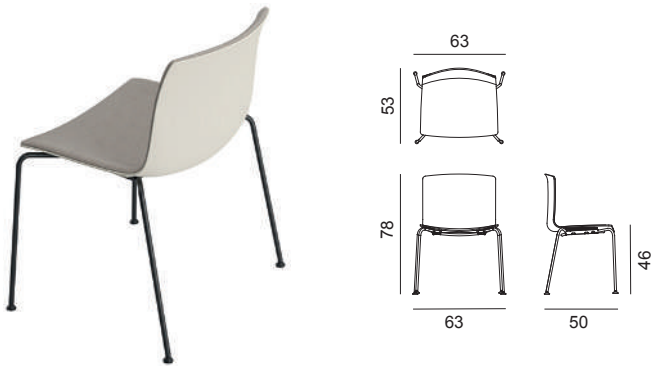

Chair with four-leg steel frame, available in chromed or powder-coated version. The matt polypropylene shell has a front upholstery in leather, coated fabric, fabric or customer's material. Steel armrests, also upholstered, are available upon request.

#### Accessories:

- Stacking protection pad Art. 0228
- Link Art. 0258
- Single trolley Art. 0500
- Trolley Art. 0760
- Stacking protection pad with link Art. 2013
- Set of glides Art. 2015
- Movable link Art. 2073

#### Stackability:

(should the weight exceed 25 kilos a handling tool must be used).

- with stacking pad, without tools up to 8 units
- with stacking pad, with trolley up to 8 units
- with link: with stacking pad, without tools up to 8 units
- with link: with stacking pad, with trolley up to 8 units
- leather / coated fabric: with stacking pad, without tools up to 5 units
- leather / coated fabric: with stacking pad, with trolley up to 5 units
- leather / coated fabric with link: with stacking pad, without tools up to 5 units
- leather / coated fabric with link: with stacking pad, with trolley up to 5 units
- with arms (BV version only): without tools up to 5 units
- with arms (BV version only): with trolley up to 5 units
- with arms (BV version only) with link: without tools up to 5 units
- with arms (BV version only) with link: with trolley up to 5 units

SEK ART. 2040	A	B COM	C COL	D	E	F	G	H	I	J	K	L	M	ES
CHROMED / POWDERCOATED	5167	5321	5475	5629	5783	5937	6091	6245	6399	6553	6707	6861	7015	8989
Armrests BV	+ 1083													
Armrests CI - only pad	+ 727													
SHIPMENT DETAILS	TECHNICAL SPECIFICATIONS				RESISTANCE TEST									
<b>Art.2040</b> 1 pz = 2  - kg 11,3/ m³ 0,301 1 pz = 3  - kg 13,66/ m³ 0,329 4 pz = 2  - kg 34,2/ m³ 0,408 4 pz = 3  - kg 42,1/ m³ 0,444 	<b>Art.2040</b> COL requirement m² 1 H 140 cm. COM Meterage m 0.72				• ENV 581-2 Appendice A.3.1									
FIRE RETARDANT TEST														
Classe 1IM Omologazione Italia Divina MD Kvadrat. Divina Melange 3 Kvadrat. Divina 3 Kvadrat. Revive 1 Kvadrat. Coated fabric Valencia Spradling.														

#### Frame Base



#### Shell



#### Armrest





# Catifa 53

Design by Lievore Altherr Molina, 2012

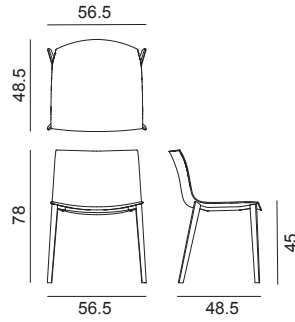

Chair with oak timber four-leg base (natural oak, bleached oak, wengè) and matt polypropylene single-colour or, alternatively, the shell can be covered in hard leather without padding. Provided with glides suitable for different surfaces.

Accessories:  
Cushion Art. 0230  
Cushion Art. 0231  
Link Art. 0258  
Removable cover Art. 3116

<b>SEK ART. 2084</b>	CT	PO single-color	
WOOD LEGS	7168	3560	
Polypropylene fire retardant (only for PO)	+ 441		(For all finishes qty min. 300 pcs)

SHIPMENT DETAILS	TECHNICAL SPECIFICATIONS	RESISTANCE TEST
<b>Art.2084</b> 1 pz = 2  - kg 9,5/ m³ 0,297 4 pz = 2  - kg 26,54/ m³ 0,368 	<b>Art.2084</b> *Classe 1, 2, 11M: fire retardant version available with surcharge and eventual minimum batch	<ul style="list-style-type: none"> <li>• EN 1728:2012 - EN 16139:2013 6.15</li> <li>• EN 1728:2012 - EN 16139:2013 6.17</li> <li>• EN 1728:2012 - EN 16139:2013 6.4</li> <li>• EN 1728:2012 - EN 16139:2013 6.16</li> <li>• EN 1728:2012 - EN 16139:2013 6.18</li> <li>• EN 1728:2012 - EN 16139:2013 6.5</li> </ul>

### FIRE RETARDANT TEST

\* FIRE RETARDANT VERSION WITH SURCHARGE \* Classe 1 Omologazione Italia Polipropilene.

### Frame Base

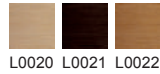

### Shell



## Catifa 53

Design by Lievore Altherr Molina, 2012

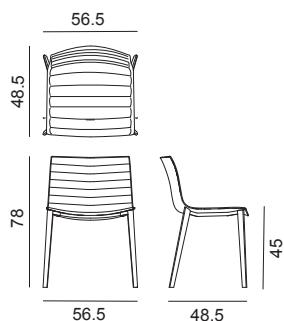

Chair with oak timber four-leg base (natural oak, bleached oak, wengé) and shell upholstered in leather, coated fabric, fabric or customer's material. Line detail stitching. Provided with glides suitable for different surfaces.

Accessories:  
Link Art. 0258

SEK ART. 2085	A	B COM	C COL	D	E	F	G	H	I	J	K	L	M	ES
WOOD LEGS	6645	6991	7337	7683	8029	8375	8721	9067	9413	9759	10105	10451	10797	11907
<b>SHIPMENT DETAILS</b>	<b>TECHNICAL SPECIFICATIONS</b>				<b>RESISTANCE TEST</b>									
<b>Art.2085</b> 1 pz = 2  - kg 10,5/ m³ 0,301 4 pz = 2  - kg 30,94/ m³ 0,408 	<b>Art.2085</b> COL requirement m² 1.78 H 140 cm. COM Meterage m 1.21													
<b>FIRE RETARDANT TEST</b>														
Classe 11M Omologazione Italia Divina MD Kvadrat. Divina Melange 3 Kvadrat. Divina 3 Kvadrat. Coated fabric Valencia Spradling.														

Frame Base

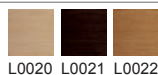

L0020 L0021 L0022



# Catifa 53

Design by Lievore Altherr Molina, 2013

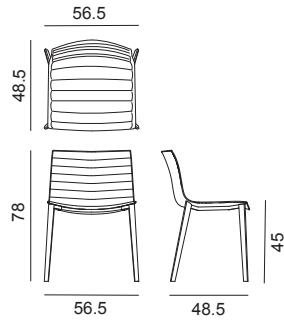

Chair with oak timber four-leg base (natural oak, bleached oak, wengé) and white polypropylene shell upholstered with a removable non-washable cover in leather, coated fabric, fabric or customer's own material. The cover stitching comes in the same color as the upholstery. Stitching on cover 1 and 3 comes in white or black, to customer's choice. The chair is provided already fitted with the cover.

Accessories:  
Link Art. 0258

SEK ART. 3118	A	B COM	C COL	D	E	F	G	H	I	J	K	L	M	ES
WOOD LEGS - Cover 1	6430	6776	7122	7468	7814	8160	8506	8852	9198	9544	9890	10236	10582	11740
WOOD LEGS - Cover 2	6680	7026	7372	7718	8064	8410	8756	9102	9448	9794	10140	10486	10832	12002
WOOD LEGS - Cover 3	6430	6776	7122	7468	7814	8160	8506	8852	9198	9544	9890	10236	10582	11740
WOOD LEGS - Cover 4	6133	6479	6825	7171	7517	7863	8209	8555	8901	9247	9593	9939	10285	11455

SHIPMENT DETAILS	TECHNICAL SPECIFICATIONS	RESISTANCE TEST
<b>Art.3118</b> 1 pz = 2  - kg 10,5/ m³ 0,301 4 pz = 2  - kg 30,94/ m³ 0,408 	<b>Art.3118</b> COL requirement m² 2.08 H 140 cm. COM Meterage m 1.23	
<b>FIRE RETARDANT TEST</b> Classe 1IM Omologazione Italia Divina MD Kvadrat. Divina Melange 3 Kvadrat. Divina 3 Kvadrat. Coated fabric Valencia Spradling.		

Frame Base

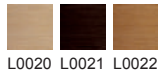

# Catifa 53

Design by Lievore Altherr Molina, 2012

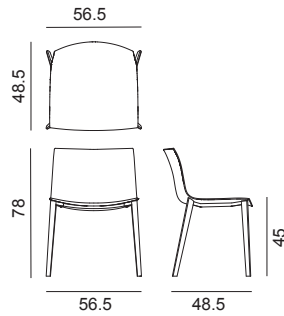

Chair with oak timber four-leg base (natural oak, bleached oak, wengé) and matt polypropylene shell with front upholstery in fabric, leather, coated fabric or customer's material. Provided with glides suitable for different surfaces.

Accessories:  
Link Art. 0258

SEK ART. 2086	A	B COM	C COL	D	E	F	G	H	I	J	K	L	M	ES
WOOD LEGS	6573	6727	6881	7035	7189	7343	7497	7651	7805	7959	8113	8267	8421	10395
<b>SHIPMENT DETAILS</b>	<b>TECHNICAL SPECIFICATIONS</b>				<b>RESISTANCE TEST</b>									
<b>Art.2086</b> 1 pz = 2  - kg 11,3/ m³ 0,301 4 pz = 2  - kg 34,2/ m³ 0,408 KD	<b>Art.2086</b> COL requirement m² 1 H 140 cm. COM Meterage m 0.72													
<b>FIRE RETARDANT TEST</b>														
Classe 1IM Omologazione Italia Divina MD Kvadrat. Divina Melange 3 Kvadrat. Divina 3 Kvadrat. Revive 1 Kvadrat. Coated fabric Valencia Spradling.														

## Frame Base

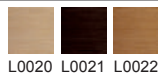

## Shell



# Catifa 53

Design by Lievore Altherr Molina, 2001

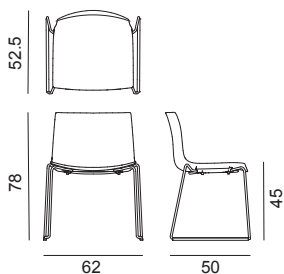

Chair with chromed or powdercoated steel sled base and matt polypropylene single-colour shell or covered in hard leather without padding. Optional glides with felt for wooden floors are available upon request. Polypropylene and steel armrests, are available upon request.

Accessories:  
 Stacking protection pad Art. 0228  
 Cushion Art. 0230  
 Cushion Art. 0231  
 Link Art. 0258  
 Single trolley Art. 0500  
 Trolley Art. 0760  
 Stacking protection pad with link Art. 2013  
 Stacking protection pad Art. 3115  
 Removable cover Art. 3116

Stackability:  
 (should the weight exceed 25 kilos a handling tool must be used).

- without tools up to 10 units
- with trolley up to 20 units

- CT: with stacking pad, without tools up to 5 units
- CT: with stacking pad, with trolley up to 5 units
- CT with link: with stacking pad, without tools up to 5 units
- CT with link: with stacking pad, with trolley up to 5 units

- with arms: without tools non stackable.
- with arms: with trolley non stackable.
- with arms with link: without tools non stackable.
- with arms with link: with trolley non stackable.

SEK ART. 2074	CT	PO single-color	
CHROMED / POWDERCOATED	6108	2500	
Armrests BV	+ 1083		
Armrests CV - pad (only for PO)	+ 334		
Hole on shell to allow water drainage (only for PO)	+ 143		
Outdoor powdercoated	+ 500		
Polypropylene fire retardant (only for PO)	+ 441		(For all finishes qty min. 300 pcs)

SHIPMENT DETAILS	TECHNICAL SPECIFICATIONS	RESISTANCE TEST
<b>Art.2074</b> 1 pz = 2  - kg 9,5/ m³ 0,297 1 pz = 3  - kg 9,5/ m³ 0,297 4 pz = 2  - kg 26,54/ m³ 0,368 4 pz = 3  - kg 26,54/ m³ 0,368 KD	<b>Art.2074</b> Outdoor: only for PO, V12, V39 Outdoor powdercoated *Classe 1, 2, 11M: fire retardant version available with surcharge and eventual minimum batch	

**FIRE RETARDANT TEST**  
 • FIRE RETARDANT VERSION WITH SURCHARGE \* Classe 1 Omologazione Italia Polipropilene.

## Frame Base



## Shell



## Armrest



# Catifa 53

Design by Lievore Altherr Molina, 2001

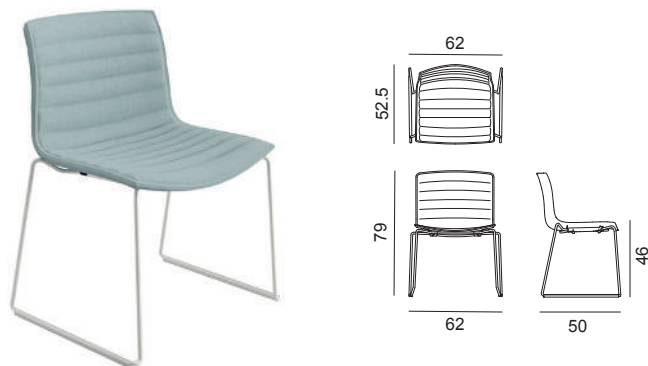

Chair with chromed or powdercoated steel sled base and shell upholstered in leather, coated fabric, fabric or customer's material. Line detail stitching. Optional glides with felt for wooden floors are available upon request. Steel armrests, also upholstered, are available upon request.

Accessories:  
 Stacking protection pad Art. 0228  
 Link Art. 0258  
 Single trolley Art. 0500  
 Trolley Art. 0760  
 Stacking protection pad with link Art. 2013

### Stackability:

(should the weight exceed 25 kilos a handling tool must be used).

- with stacking pad, without tools up to 8 units
- with stacking pad, with trolley up to 8 units
- with link: with stacking pad, without tools up to 8 units
- with link: with stacking pad, with trolley up to 8 units
- leather / coated fabric: with stacking pad, without tools up to 5 units
- leather / coated fabric: with stacking pad, with trolley up to 5 units
- leather / coated fabric with link: with stacking pad, without tools up to 5 units
- leather / coated fabric with link: with stacking pad, with trolley up to 5 units
- with arms: with stacking pad, without tools non stackable.
- with arms: with stacking pad, with trolley non stackable.
- with arms with link: with stacking pad, without tools non stackable.
- with arms with link: with stacking pad, with trolley non stackable.

SEK ART. 2075	A	B COM	C COL	D	E	F	G	H	I	J	K	L	M	ES
CHROMED / POWDERCOATED	5585	5931	6277	6623	6969	7315	7661	8007	8353	8699	9045	9391	9737	10847
Armrests BV	+ 1083													
Armrests CI - only pad	+ 727													
SHIPMENT DETAILS	TECHNICAL SPECIFICATIONS				RESISTANCE TEST									
<b>Art.2075</b> 1 pz = 2  - kg 12,3/ m³ 0,335 1 pz = 3  - kg 12,3/ m³ 0,335 4 pz = 2  - kg 41,3/ m³ 0,472 4 pz = 3  - kg 41,3/ m³ 0,472 KD	<b>Art.2075</b> COL requirement m² 1.78 H 140 cm. COM Meterage m 1.21													
FIRE RETARDANT TEST														
Classe 1IM Omologazione Italia Divina MD Kvadrat. Divina Melange 3 Kvadrat. Divina 3 Kvadrat. Coated fabric Valencia Spradling.														

### Frame Base



### Armrest

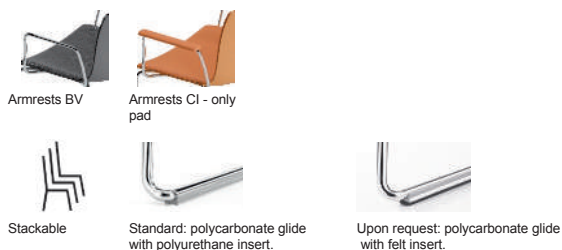

# Catifa 53

Design by Lievore Altherr Molina, 2013

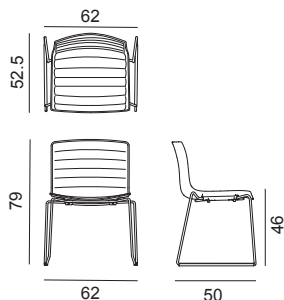

Chair with chromed or powder-coated steel sled base and white polypropylene shell upholstered with a removable non-washable cover in leather, coated fabric, fabric or customer's own material. The cover stitching comes in the same color as the upholstery. Stitching on cover 1 and 3 comes in white or black, to customer's choice. The chair is provided already fitted with the cover. Optional glides with felt for wooden floors are available upon request. Steel armrests are available upon request.

Accessories:  
 Stacking protection pad Art. 0228  
 Link Art. 0258  
 Single trolley Art. 0500  
 Trolley Art. 0760  
 Stacking protection pad with link Art. 2013  
 Stacking protection pad Art. 3115

### Stackability:

(should the weight exceed 25 kilos a handling tool must be used).

- with stacking pad, without tools up to 8 units
- with stacking pad, with trolley up to 8 units
- with link: with stacking pad, without tools up to 8 units
- with link: with stacking pad, with trolley up to 8 units

- leather / coated fabric: with stacking pad, without tools up to 5 units
- leather / coated fabric: with stacking pad, with trolley up to 5 units
- leather / coated fabric with link: with stacking pad, without tools up to 5 units
- leather / coated fabric with link: with stacking pad, with trolley up to 5 units

- with arms: with stacking pad, without tools non stackable.
- with arms: with stacking pad, with trolley non stackable.
- with arms with link: with stacking pad, without tools non stackable.
- with arms with link: with stacking pad, with trolley non stackable.

SEK ART. 3120	A	B COM	C COL	D	E	F	G	H	I	J	K	L	M	ES
CHROMED / POWDERCOATED - Cover 1	5370	5716	6062	6408	6754	7100	7446	7792	8138	8484	8830	9176	9522	10680
CHROMED / POWDERCOATED - Cover 2	5620	5966	6312	6658	7004	7350	7696	8042	8388	8734	9080	9426	9772	10942
CHROMED / POWDERCOATED - Cover 3	5370	5716	6062	6408	6754	7100	7446	7792	8138	8484	8830	9176	9522	10680
CHROMED / POWDERCOATED - Cover 4	5073	5419	5765	6111	6457	6803	7149	7495	7841	8187	8533	8879	9225	10395
Armrests BV	+ 1083													
<b>SHIPMENT DETAILS</b>	<b>TECHNICAL SPECIFICATIONS</b>				<b>RESISTANCE TEST</b>									
<b>Art.3120</b> 1 pz = 2  - kg 12,3/ m³ 0,335 1 pz = 3  - kg 12,3/ m³ 0,335 4 pz = 2  - kg 41,3/ m³ 0,472 4 pz = 3  - kg 41,3/ m³ 0,472 KD	<b>Art.3120</b> COL requirement m² 2.08 H 140 cm. COM Meterage m 1.23													
<b>FIRE RETARDANT TEST</b>														
Classe 1IM Omologazione Italia Divina MD Kvadrat. Divina Melange 3 Kvadrat. Divina 3 Kvadrat. Coated fabric Valencia Spradling.														

### Frame Base



### Armrest



# Catifa 53

Design by Lievore Altherr Molina, 2001

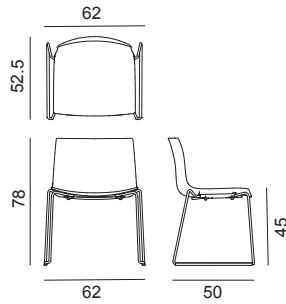

Chair with chromed or powder-coated steel sled base and matt polypropylene shell with front upholstery in fabric, leather, coated fabric or customer's material. Optional glides with felt for wooden floors are available upon request. Steel armrests, also upholstered, are available upon request.

#### Accessories:

- Stacking protection pad Art. 0228
- Link Art. 0258
- Single trolley Art. 0500
- Trolley Art. 0760
- Stacking protection pad with link Art. 2013

#### Stackability:

(should the weight exceed 25 kilos a handling tool must be used).

- with stacking pad, without tools up to 8 units
- with stacking pad, with trolley up to 8 units
- with link: with stacking pad, without tools up to 8 units
- with link: with stacking pad, with trolley up to 8 units
- leather / coated fabric: with stacking pad, without tools up to 5 units
- leather / coated fabric: with stacking pad, with trolley up to 5 units
- leather / coated fabric with link: with stacking pad, without tools up to 5 units
- leather / coated fabric with link: with stacking pad, with trolley up to 5 units
- with arms: with stacking pad, without tools non stackable.
- with arms: with stacking pad, with trolley non stackable.
- with arms with link: with stacking pad, without tools non stackable.
- with arms with link: with stacking pad, with trolley non stackable.

SEK ART. 2076	A	B COM	C COL	D	E	F	G	H	I	J	K	L	M	ES
CHROMED / POWDERCOATED	5513	5667	5821	5975	6129	6283	6437	6591	6745	6899	7053	7207	7361	9335
Armrests BV	+ 1083													
Armrests CI - only pad	+ 727													

SHIPMENT DETAILS	TECHNICAL SPECIFICATIONS	RESISTANCE TEST
<b>Art.2076</b> 1 pz = 2  - kg 13,1/ m³ 0,335 1 pz = 3  - kg 13,1/ m³ 0,335 4 pz = 2  - kg 44,56/ m³ 0,472 4 pz = 3  - kg 44,56/ m³ 0,472 	<b>Art.2076</b> COL requirement m² 1 H 140 cm. COM Meterage m 0.72 *Classe 1, 2, 11M: fire retardant version available with surcharge and eventual minimum batch	

**FIRE RETARDANT TEST**  
 Classe 11M Omologazione Italia Divina MD Kvadrat. Divina Melange 3 Kvadrat. Divina 3 Kvadrat. Revive 1 Kvadrat. Coated fabric Valencia Spradling.  
 • FIRE RETARDANT VERSION WITH SURCHARGE \* Classe 1 Omologazione Italia Polipropilene.

#### Frame Base



#### Shell



#### Armrest



Stackable



Standard: polycarbonate glide with polyurethane insert.



Upon request: polycarbonate glide with felt insert.





# Catifa 53

Design by Lievore Altherr Molina, 2001

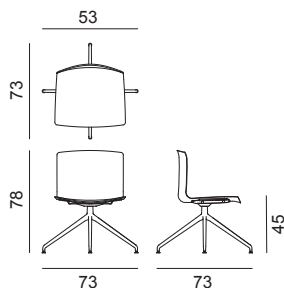

Chair with polished or powdercoated aluminium swivel trestle base. Matt polypropylene shell available in single colour or covered in hard leather without padding. Polypropylene and steel armrests, are available upon request.

Accessories:  
 Cushion Art. 0230  
 Cushion Art. 0231  
 Set of glides Art. 2015  
 Removable cover Art. 3116

<b>SEK ART. 2054</b>	<b>CT</b>	<b>PO single-color</b>	
POLISHED / POWDERCOATED	7620	4012	
Armrests BV	+ 1083		
Armrests CV - pad (only for PO)	+ 334		
Polypropylene fire retardant (only for PO)	+ 441 (For all finishes qty min. 300 pcs)		
<b>SHIPMENT DETAILS</b>	<b>TECHNICAL SPECIFICATIONS</b>		<b>RESISTANCE TEST</b>
<b>Art.2054</b> 1 pz = 2  - kg 10,7/ m³ 0,278 1 pz = 3  - kg 13,8/ m³ 0,307 4 pz = 2  - kg 31,8/ m³ 0,376 4 pz = 3  - kg 39,94/ m³ 0,412 	<b>Art.2054</b> *Classe 1, 2, 11M: fire retardant version available with surcharge and eventual minimum batch		<ul style="list-style-type: none"> <li>• EN 1728:2012 - EN 16139:2013 6.10</li> <li>• EN 1728:2012 - EN 16139:2013 6.15</li> <li>• EN 1728:2012 - EN 16139:2013 6.17</li> <li>• EN 1728:2012 - EN 16139:2013 6.20</li> <li>• EN 1728:2012 - EN 16139:2013 6.26</li> <li>• EN 1728:2012 - EN 16139:2013 6.5</li> </ul> <ul style="list-style-type: none"> <li>• EN 1728:2012 - EN 16139:2013 6.11</li> <li>• EN 1728:2012 - EN 16139:2013 6.16</li> <li>• EN 1728:2012 - EN 16139:2013 6.18</li> <li>• EN 1728:2012 - EN 16139:2013 6.24</li> <li>• EN 1728:2012 - EN 16139:2013 6.4</li> </ul>
<b>FIRE RETARDANT TEST</b>			
• FIRE RETARDANT VERSION WITH SURCHARGE * Classe 1 Omologazione Italia Polipropilene.			

## Frame Base



## Shell



## Armrest



# Catifa 53

Design by Lievore Altherr Molina, 2001

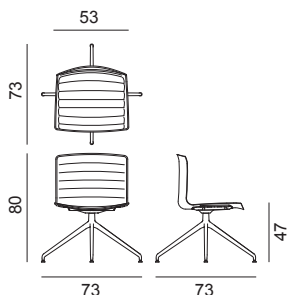

Chair with polished or powdercoated aluminium swivel trestle base. The shell is upholstered in leather, coated fabric, fabric or customer's material. Line detail stitching. Steel armrests, also padded, are available upon request.

Accessories:  
Set of glides Art. 2015

SEK ART. 2060	A	B COM	C COL	D	E	F	G	H	I	J	K	L	M	ES
POLISHED / POWDERCOATED	7097	7443	7789	8135	8481	8827	9173	9519	9865	10211	10557	10903	11249	12359
Armrests BV	+ 1083													
Armrests CI - only pad	+ 727													
SHIPMENT DETAILS	TECHNICAL SPECIFICATIONS				RESISTANCE TEST									
<b>Art.2060</b> 1 pz = 2  - kg 11,7/ m³ 0,282 1 pz = 3  - kg 14,8/ m³ 0,311 4 pz = 2  - kg 36,2/ m³ 0,416 4 pz = 3  - kg 44,34/ m³ 0,452 	<b>Art.2060</b> COL requirement m² 1.78 H 140 cm. COM Meterage m 1.21													
FIRE RETARDANT TEST														
Classe 1IM Omologazione Italia Divina MD Kvadrat. Divina Melange 3 Kvadrat. Divina 3 Kvadrat. Coated fabric Valencia Spradling.														

## Frame Base



## Armrest



# Catifa 53

Design by Lievore Altherr Molina, 2013

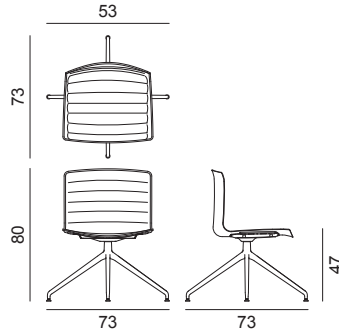

Chair with polished or powder-coated aluminium swivel trestle base. The white polypropylene shell is upholstered with a removable non-washable cover in leather, coated fabric, fabric or customer's own material. The cover stitching comes in the same color as the upholstery. Stitching on cover 1 and 3 comes in white or black, to customer's choice. The chair is provided already fitted with the cover. Steel armrests are available upon request.

Accessories:  
Set of glides Art. 2015

SEK ART. 3125	A	B COM	C COL	D	E	F	G	H	I	J	K	L	M	ES
POLISHED / POWDERCOATED - Cover 1	6882	7228	7574	7920	8266	8612	8958	9304	9650	9996	10342	10688	11034	12192
POLISHED / POWDERCOATED - Cover 2	7132	7478	7824	8170	8516	8862	9208	9554	9900	10246	10592	10938	11284	12454
POLISHED / POWDERCOATED - Cover 3	6882	7228	7574	7920	8266	8612	8958	9304	9650	9996	10342	10688	11034	12192
POLISHED / POWDERCOATED - Cover 4	6585	6931	7277	7623	7969	8315	8661	9007	9353	9699	10045	10391	10737	11907
Armrests BV	+ 1083													

SHIPMENT DETAILS	TECHNICAL SPECIFICATIONS	RESISTANCE TEST
<b>Art.3125</b> 1 pz = 2  - kg 11,7/ m³ 0,282 1 pz = 3  - kg 14,8/ m³ 0,311 4 pz = 2  - kg 36,2/ m³ 0,416 4 pz = 3  - kg 44,34/ m³ 0,452 KD	<b>Art.3125</b> COL requirement m² 2.08 H 140 cm. COM Meterage m 1.23	

FIRE RETARDANT TEST
Classe 1IM Omologazione Italia Divina MD Kvadrat. Divina Melange 3 Kvadrat. Divina 3 Kvadrat. Coated fabric Valencia Spradling.

## Frame Base



## Armrest



Armrests BV



Cover 1

Cover 2

Cover 3

Cover 4



# Catifa 53

Design by Lievore Altherr Molina, 2001

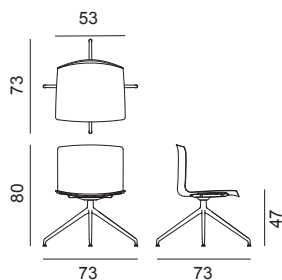

Chair with polished or powder-coated aluminium swivel trestle base. Matt polypropylene shell with front upholstery in leather, fabric or customer's material. Steel armrests, also padded, are available upon request.

Accessories:  
Set of glides Art. 2015

SEK ART. 2056	A	B COM	C COL	D	E	F	G	H	I	J	K	L	M	ES
POLISHED / POWDERCOATED	7025	7179	7333	7487	7641	7795	7949	8103	8257	8411	8565	8719	8873	10847
Armrests BV	+ 1083													
Armrests CI - only pad	+ 727													

SHIPMENT DETAILS	TECHNICAL SPECIFICATIONS	RESISTANCE TEST
<b>Art.2056</b> 1 pz = 2  - kg 12,6/ m³ 0,282 1 pz = 3  - kg 14,98/ m³ 0,311 4 pz = 2  - kg 39,8/ m³ 0,416 4 pz = 3  - kg 47,94/ m³ 0,452 	<b>Art.2056</b> COL requirement m² 1 H 140 cm. COM Meterage m 0.72 *Classe 1, 2, 11M: fire retardant version available with surcharge and eventual minimum batch	
<b>FIRE RETARDANT TEST</b> Classe 11M Omologazione Italia Divina MD Kvadrat. Divina Melange 3 Kvadrat. Divina 3 Kvadrat. Revive 1 Kvadrat. Coated fabric Valencia Spradling. * FIRE RETARDANT VERSION WITH SURCHARGE * Classe 1 Omologazione Italia Polipropilene.		

## Frame Base



## Shell



## Armrest



# Catifa 53

Design by Lievore Altherr Molina, 2001

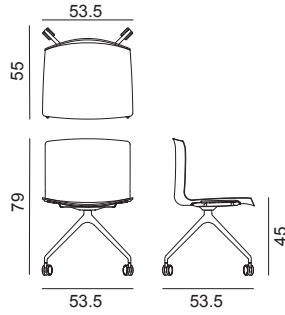

Chair with polished or powdercoated aluminium fixed trestle base mounted on self-braking castors (color matching with base). Matt polypropylene shell available in single-colour or covered in hard leather without padding. Polypropylene and steel armrests, are available upon request.

Accessories:  
Cushion Art. 0230  
Cushion Art. 0231  
Removable cover Art. 3116

SEK ART. 2055	CT	PO single-color	
POLISHED / POWDERCOATED	8025	4417	
Armrests BV	+ 1083		
Armrests CV - pad (only for PO)	+ 334		
Polypropylene fire retardant (only for PO)	+ 441		(For all finishes qty min. 300 pcs)
SHIPMENT DETAILS	TECHNICAL SPECIFICATIONS		RESISTANCE TEST
<b>Art.2055</b> 1 pz = 2  - kg 10,8/ m³ 0,284 1 pz = 3  - kg 13,18/ m³ 0,313 4 pz = 2  - kg 32,2/ m³ 0,38 4 pz = 3  - kg 40,34/ m³ 0,416 	<b>Art.2055</b> *Classe 1, 2, 11M: fire retardant version available with surcharge and eventual minimum batch		<ul style="list-style-type: none"> <li>• EN 1728:2012 - EN 16139:2013 6.10</li> <li>• EN 1728:2012 - EN 16139:2013 6.15</li> <li>• EN 1728:2012 - EN 16139:2013 6.20</li> <li>• EN 1728:2012 - EN 16139:2013 6.4</li> </ul> <ul style="list-style-type: none"> <li>• EN 1728:2012 - EN 16139:2013 6.11</li> <li>• EN 1728:2012 - EN 16139:2013 6.16</li> <li>• EN 1728:2012 - EN 16139:2013 6.26</li> <li>• EN 1728:2012 - EN 16139:2013 6.5</li> </ul>
FIRE RETARDANT TEST			
• FIRE RETARDANT VERSION WITH SURCHARGE * Classe 1 Omologazione Italia Polipropilene.			

## Frame Base



## Shell



## Armrest



# Catifa 53

Design by Lievore Altherr Molina, 2001

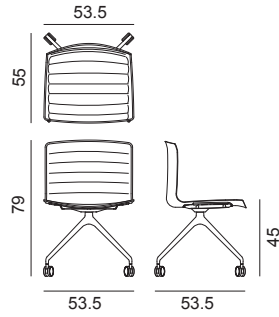

Chair with polished or powdercoated aluminium fixed trestle base, mounted on self-braking castors (color matching with base). The shell is upholstered in leather, coated fabric, fabric or customer's material. Line detail stitching. Steel armrests, also padded, are available upon request.

SEK ART. 2061	A	B COM	C COL	D	E	F	G	H	I	J	K	L	M	ES
POLISHED / POWDERCOATED	7502	7848	8194	8540	8886	9232	9578	9924	10270	10616	10962	11308	11654	12764
Armrests BV	+ 1083													
Armrests CI - only pad	+ 727													
SHIPMENT DETAILS	TECHNICAL SPECIFICATIONS				RESISTANCE TEST									
<b>Art.2061</b> 1 pz = 2  - kg 11,8/ m³ 0,288 1 pz = 3  - kg 14,18/ m³ 0,317 4 pz = 2  - kg 36,6/ m³ 0,42 4 pz = 3  - kg 44,74/ m³ 0,456 KD	<b>Art.2061</b> COL requirement m² 1.78 H 140 cm. COM Meterage m 1.21													
FIRE RETARDANT TEST														
Classe 1IM Omologazione Italia Divina MD Kvadrat. Divina Melange 3 Kvadrat. Divina 3 Kvadrat. Coated fabric Valencia Spradling.														

## Frame Base

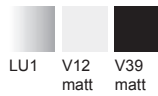

## Armrest



# Catifa 53

Design by Lievore Altherr Molina, 2013

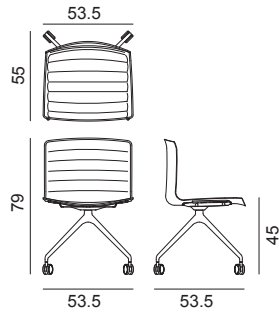

Chair with polished or powder-coated aluminium fixed trestle base, mounted on self-braking castors (color matching with base). The white polypropylene shell is upholstered with a removable non-washable cover in leather, coated fabric, fabric or customer's own material. The cover stitching comes in the same color as the upholstery. Stitching on cover 1 and 3 comes in white or black, to customer's choice. The chair is provided already fitted with the cover. Steel armrests are available upon request.

SEK ART. 3126	A	B COM	C COL	D	E	F	G	H	I	J	K	L	M	ES
POLISHED / POWDERCOATED - Cover 1	7287	7633	7979	8325	8671	9017	9363	9709	10055	10401	10747	11093	11439	12597
POLISHED / POWDERCOATED - Cover 2	7537	7883	8229	8575	8921	9267	9613	9959	10305	10651	10997	11343	11689	12859
POLISHED / POWDERCOATED - Cover 3	7287	7633	7979	8325	8671	9017	9363	9709	10055	10401	10747	11093	11439	12597
POLISHED / POWDERCOATED - Cover 4	6990	7336	7682	8028	8374	8720	9066	9412	9758	10104	10450	10796	11142	12312
Armrests BV	+ 1083													

SHIPMENT DETAILS	TECHNICAL SPECIFICATIONS	RESISTANCE TEST
<b>Art.3126</b> 1 pz = 2  - kg 11,8/ m³ 0,288 1 pz = 3  - kg 14,18/ m³ 0,317 4 pz = 2  - kg 36,6/ m³ 0,42 4 pz = 3  - kg 44,74/ m³ 0,456 KD	<b>Art.3126</b> COL requirement m² 2.08 H 140 cm. COM Meterage m 1.23	

FIRE RETARDANT TEST
Classe 1IM Omologazione Italia Divina MD Kvadrat. Divina Melange 3 Kvadrat. Divina 3 Kvadrat. Coated fabric Valencia Spradling.

## Frame Base



## Armrest



Armrests BV



Cover 1 Cover 2 Cover 3 Cover 4



# Catifa 53

Design by Lievore Altherr Molina, 2001

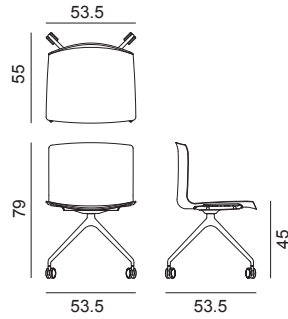

Chair with polished or powder-coated aluminium fixed trestle base, mounted on self-braking castors (color matching with base). Matt polypropylene shell with front upholstery in leather, coated fabric, fabric or customer's material upholstery applied to the seat surface. Steel armrests, also padded, are available upon request.

SEK ART. 2057	A	B COM	C COL	D	E	F	G	H	I	J	K	L	M	ES
POLISHED / POWDERCOATED	7430	7584	7738	7892	8046	8200	8354	8508	8662	8816	8970	9124	9278	11252
Armrests BV	+ 1083													
Armrests CI - only pad	+ 727													
SHIPMENT DETAILS	TECHNICAL SPECIFICATIONS				RESISTANCE TEST									
<b>Art.2057</b> 1 pz = 2  - kg 12,7/ m³ 0,288 1 pz = 3  - kg 15,08/ m³ 0,317 4 pz = 2  - kg 40,2/ m³ 0,42 4 pz = 3  - kg 48,34/ m³ 0,456 KD	<b>Art.2057</b> COL requirement m² 1 H 140 cm. COM Meterage m 0.72													
FIRE RETARDANT TEST														
Classe 1IM Omologazione Italia Divina MD Kvadrat. Divina Melange 3 Kvadrat. Divina 3 Kvadrat. Revive 1 Kvadrat. Coated fabric Valencia Spradling.														

## Frame Base

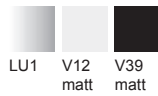

## Shell



## Armrest





# Catifa 53

Design by Lievore Altherr Molina, 2001

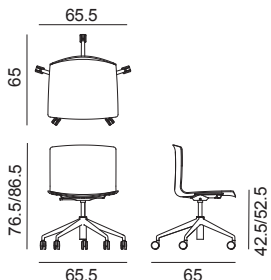

Chair with polished or powdercoated aluminum five star swivel base, mounted on self-braking castors (color matching with base) and equipped with gas-lift mechanism for height adjustment. Matt polypropylene shell available in single-colour or covered in hard leather without padding. Polypropylene and steel armrests, are available upon request.

Accessories:  
Cushion Art. 0230  
Cushion Art. 0231  
Removable cover Art. 3116

<b>SEK ART. 0213</b>	CT	PO single-color	
GAS MECHANISM	9335	5727	
Armrests BV	+ 1083		
Armrests CV - pad (only for PO)	+ 334		
Polypropylene fire retardant (only for PO)	+ 441 (For all finishes qty min. 300 pcs)		
<b>SHIPMENT DETAILS</b>	<b>TECHNICAL SPECIFICATIONS</b>		<b>RESISTANCE TEST</b>
<b>Art.0213</b> 1 pz = 2  - kg 13,1/ m³ 0,337 1 pz = 3  - kg 15,68/ m³ 0,363 4 pz = 5  - kg 48,6/ m³ 1,008 4 pz = 6  - kg 57,54/ m³ 1,032 	<b>Art.0213</b> *Classe 1, 2, 11M: fire retardant version available with surcharge and eventual minimum batch		<ul style="list-style-type: none"> <li>UNI 9084/2002</li> </ul>
<b>FIRE RETARDANT TEST</b> • FIRE RETARDANT VERSION WITH SURCHARGE * Classe 1 Omologazione Italia Polipropilene.			

## Frame Base



## Shell



## Armrest



# Catifa 53

Design by Lievore Altherr Molina, 2001

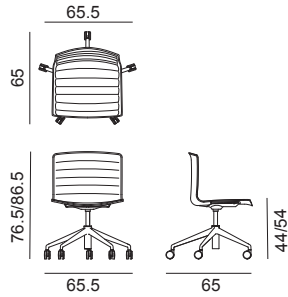

Chair with polished or powdercoated aluminum five-star swivel base, mounted on self-braking castors (color matching with base) and equipped with gas height adjustment mechanism. The shell is upholstered in leather, coated fabric, fabric or customer's material. Line detail stitching. Steel armrests, also padded, are available upon request.

SEK ART. 0215	A	B COM	C COL	D	E	F	G	H	I	J	K	L	M	ES
GAS MECHANISM	8812	9158	9504	9850	10196	10542	10888	11234	11580	11926	12272	12618	12964	14074
Armrests BV	+ 1083													
Armrests CI - only pad	+ 727													
SHIPMENT DETAILS	TECHNICAL SPECIFICATIONS				RESISTANCE TEST									
<b>Art.0215</b> 1 pz = 2  - kg 14,1/ m³ 0,341 1 pz = 3  - kg 16,68/ m³ 0,367 4 pz = 5  - kg 53/ m³ 1,048 4 pz = 6  - kg 61,94/ m³ 1,072 KD	<b>Art.0215</b> COL requirement m² 1.78 H 140 cm. COM Meterage m 1.21				• UNI 9084/2002									
FIRE RETARDANT TEST														
Classe 1IM Omologazione Italia Divina MD Kvadrat. Divina Melange 3 Kvadrat. Divina 3 Kvadrat. Coated fabric Valencia Spradling.														

## Frame Base



## Armrest



# Catifa 53

Design by Lievore Altherr Molina, 2013

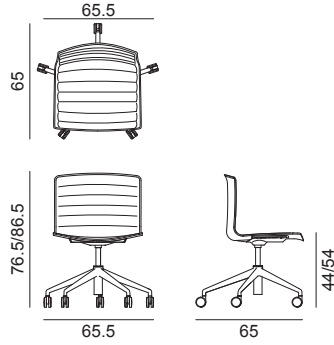

Chair with polished or powder-coated aluminum five-star swivel base, mounted on self-braking castors (color matching with base) and equipped with gas height adjustment mechanism. The white polypropylene shell is upholstered with a removable non-washable cover in leather, coated fabric, fabric or customer's own material. The cover stitching comes in the same color as the upholstery. Stitching on cover 1 and 3 comes in white or black, to customer's choice. The chair is provided already fitted with the cover. Steel armrests are available upon request.

SEK ART. 3128	A	B COM	C COL	D	E	F	G	H	I	J	K	L	M	ES
GAS MECHANISM - Cover 1	8597	8943	9289	9635	9981	10327	10673	11019	11365	11711	12057	12403	12749	13907
GAS MECHANISM - Cover 2	8847	9193	9539	9885	10231	10577	10923	11269	11615	11961	12307	12653	12999	14169
GAS MECHANISM - Cover 3	8597	8943	9289	9635	9981	10327	10673	11019	11365	11711	12057	12403	12749	13907
GAS MECHANISM - Cover 4	8300	8646	8992	9338	9684	10030	10376	10722	11068	11414	11760	12106	12452	13622
Armrests BV	+ 1083													

SHIPMENT DETAILS	TECHNICAL SPECIFICATIONS	RESISTANCE TEST
<b>Art.3128</b> 1 pz = 2  - kg 14,1/ m³ 0,341 1 pz = 3  - kg 16,68/ m³ 0,367 4 pz = 5  - kg 53/ m³ 1,048 4 pz = 6  - kg 61,94/ m³ 1,072 KD	<b>Art.3128</b> COL requirement m² 2.08 H 140 cm. COM Meterage m 1.23	• UNI 9084/2002

FIRE RETARDANT TEST
Classe 11M Omologazione Italia Divina MD Kvadrat. Divina Melange 3 Kvadrat. Divina 3 Kvadrat. Coated fabric Valencia Spradling.

### Frame Base



### Armrest



Armrests BV



Cover 1 Cover 2 Cover 3 Cover 4



# Catifa 53

Design by Lievore Altherr Molina, 2001

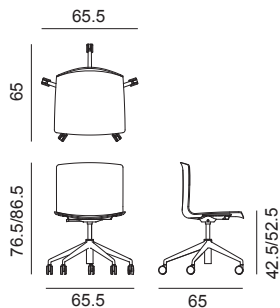

Chair with polished or powder-coated aluminum five-star swivel base, mounted on self-braking castors (color matching with base) and equipped with gas height adjustment mechanism. Matt polypropylene shell with leather, coated fabric, fabric or customer's material upholstery applied to the seat surface. Steel armrests, also padded, are available upon request.

SEK ART. 2048	A	B COM	C COL	D	E	F	G	H	I	J	K	L	M	ES
GAS MECHANISM	8740	8894	9048	9202	9356	9510	9664	9818	9972	10126	10280	10434	10588	12562
Armrests BV	+ 1083													
Armrests CI - only pad	+ 727													
SHIPMENT DETAILS	TECHNICAL SPECIFICATIONS				RESISTANCE TEST									
<b>Art.2048</b> 1 pz = 2  - kg 14,9/ m³ 0,341 1 pz = 3  - kg 17,48/ m³ 0,367 4 pz = 5  - kg 56,28/ m³ 1,048 4 pz = 6  - kg 65,2/ m³ 1,072 	<b>Art.2048</b> COL requirement m² 1 H 140 cm. COM Meterage m 0.72				<ul style="list-style-type: none"> <li>UNI 9084/2002</li> </ul>									
FIRE RETARDANT TEST														
Classe 1IM Omologazione Italia Divina MD Kvadrat. Divina Melange 3 Kvadrat. Divina 3 Kvadrat. Revive 1 Kvadrat. Coated fabric Valencia Spradling.														

## Frame Base



## Shell



## Armrest



# Catifa 53 Bench

Design by Lievore Altherr Molina, 2001



Two, three or four seater bench. Each seating position can be fitted with either a seat or a table top, offering solutions to meet all requirements. The white powdercoated metal frame can be fitted with polypropylene shells, upholstered shells or polypropylene shells upholstered with a removable non-washable cover (Art. 3129) in leather, coated fabric, fabric or customer's own material.

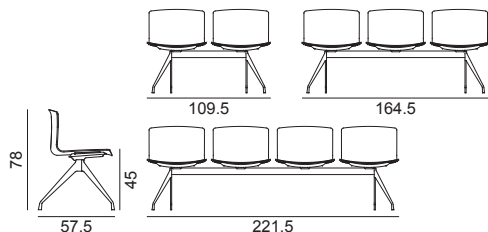

Accessories:  
Cushion Art. 0230  
Cushion Art. 0231  
Removable cover Art. 3116

SEK ART. 2036	CT	PO													
	5727	2119													
SEK ART. 2037	A	B COM	C COL	D	E	F	G	H	I	J	K	L	M	ES	
Line stitching – not removable	5204	5550	5896	6242	6588	6934	7280	7626	7972	8318	8664	9010	9356	10466	
SEK ART. 3129	A	B COM	C COL	D	E	F	G	H	I	J	K	L	M	ES	
Cover 1	4989	5335	5681	6027	6373	6719	7065	7411	7757	8103	8449	8795	9141	10299	
Cover 2	5239	5585	5931	6277	6623	6969	7315	7661	8007	8353	8699	9045	9391	10561	
Cover 3	4989	5335	5681	6027	6373	6719	7065	7411	7757	8103	8449	8795	9141	10299	
Cover 4	4692	5038	5384	5730	6076	6422	6768	7114	7460	7806	8152	8498	8844	10014	
Polypropylene fire retardant (only for PO)	441	Art. 2036 (For all finishes qty min. 300 pcs)													

SHIPMENT DETAILS	TECHNICAL SPECIFICATIONS	RESISTANCE TEST
<p><b>Art. 2036</b> 1 pz = 2  - kg 4,34/ m³ 0,134 4 pz = 3  - kg 13,66/ m³ 0,165</p> <p><b>Art. 2037</b> 1 pz = 2  - kg 4,94/ m³ 0,136 4 pz = 3  - kg 20,76/ m³ 0,21</p> <p><b>Art. 3129</b> 1 pz = 2  - kg 7,2/ m³ 0,131 4 pz = 3  - kg 22,9/ m³ 0,212</p> <p></p>	<p><b>Art.2036</b> *Classe 1, 2, 11M: fire retardant version available with surcharge and eventual minimum batch</p> <p><b>Art.2037</b> COL requirement m² 1.78 H 140 cm. COM Meterage m 1.21</p> <p><b>Art.3129</b> COL requirement m² 2.08 H 140 cm. COM Meterage m 1.23</p>	
<p><b>FIRE RETARDANT TEST</b> Classe 11M Omologazione Italia Divina MD Kvadrat. Divina Melange 3 Kvadrat. Divina 3 Kvadrat. Coated fabric Valencia Spradling. * FIRE RETARDANT VERSION WITH SURCHARGE * Classe 1 Omologazione Italia Polipropilene.</p>		



# Catifa 53 Bench

Design by Lievore Altherr Molina, 2001

## EXAMPLES OF HOW TO ORDER

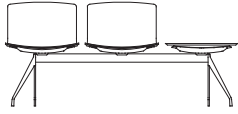

2 x Art. 2036 + Art. 2038 + Art. 3131

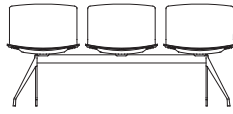

3 x Art. 2037 + Art. 3132

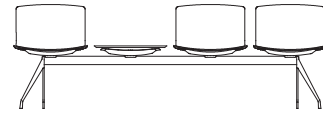

3 x Art. 2037 + Art. 2038 + Art. 3133

	<b>SEK ART. 3131</b>	2-seater beam + pair of legs	9526
	<b>SEK ART. 3132</b>	3-seater beam + pair of legs	10407
	<b>SEK ART. 3133</b>	4-seater beam + pair of legs	11765
	<b>SEK ART. 2038</b>	STEEL TABLE 52 X 40 cm	2512

SHIPMENT DETAILS	TECHNICAL SPECIFICATIONS	RESISTANCE TEST
<b>Art. 2038</b> 1 pz = 1  - kg 10,3/ m² 0,018 <b>Art. 3131</b> 1 pz = 2  - kg 8,82/ m² 0,037 <b>Art. 3132</b> 1 pz = 2  - kg 10,34/ m² 0,041 <b>Art. 3133</b> 1 pz = 2  - kg 14,88/ m² 0,045 		
<b>FIRE RETARDANT TEST</b>		

Frame Base



arper



## Accessories

Design by Lievore Altherr Molina, 2013

Fabric, leather, coated fabric or customer's own material, non-washable, removable covers are available in the following four versions: cross-shaped stitching (Cover 1), line stitching (Cover 2), starshaped stitching (Cover 3) or without stitching (Cover 4). Stitching on cover 1 and 3 comes in white or black, to customer's choice. Stitching on cover 2 and 4 comes in in the same color as the upholstery. Covers to be sold separately from shell.



Cover 1 - Cross-shaped stitching



Cover 2 - Line stitching



Cover 3 - Star-shaped stitching



Cover 4 - Without stitching

<b>SEK ART. 3116</b>	A	B COM	C COL	D	E	F	G	H	I	J	K	L	M	ES
Cover 1 - Cross-shaped stitching	3227	3573	3919	4265	4611	4957	5303	5649	5995	6341	6687	7033	7379	8502
Cover 2 - Line stitching	3453	3799	4145	4491	4837	5183	5529	5875	6221	6567	6913	7259	7605	8775
Cover 3 - Star-shaped stitching	3227	3573	3919	4265	4611	4957	5303	5649	5995	6341	6687	7033	7379	8502
Cover 4 - Without stitching	2905	3251	3597	3943	4289	4635	4981	5327	5673	6019	6365	6711	7057	8216

SHIPMENT DETAILS	TECHNICAL SPECIFICATIONS	RESISTANCE TEST
<b>Art. 3116</b> 1 pz = 1  - kg 5/ m³ 0,033 10 pz = 1  - kg 12,05/ m³ 0,151 20 pz = 1  - kg 24,03/ m³ 0,299 4 pz = 1  - kg 10/ m³ 0,033	<b>Art.3116</b> COL requirement m² 2.08 H 140 cm. COM Meterage m 1.23	
<b>FIRE RETARDANT TEST</b> Classe 1IM Omologazione Italia Divina MD Kvadrat. Divina Melange 3 Kvadrat. Divina 3 Kvadrat. Coated fabric Valencia Spradling.		



## Accessories

Design by Lievore Altherr Molina, 2011

Art. 0230: cushion with shaped padding, which ensures a perfect fit to the shape of the shell, and equipped with anti-slip on the underside. For greater comfort, the padding is in polyurethane foam and wadding, and upholstered in fabric, leather or coated fabric. Art. 0231: cushion equipped with two velcro strips on the underside to fix it to the seat. Polyurethane foam padding, upholstered in fabric, leather or coated fabric.



ART. 0230



ART. 0231

SEK ART. 0230	A	B COM	C COL	D	E	F	G	H	I	J	K	L	M	ES
SEAT CUSHION - NEW	1405	1619	1833	2047	2261	2475	2689	2903	3117	3331	3545	3759	3973	4370
SEK ART. 0231	A	B COM	C COL	D	E	F	G	H	I	J	K	L	M	ES
SEAT CUSHION	1274	1488	1702	1916	2130	2344	2558	2772	2986	3200	3414	3628	3842	4227
SHIPMENT DETAILS	TECHNICAL SPECIFICATIONS				RESISTANCE TEST									
<b>Art.0230</b> 1 pz = 1  - kg 1,3/ m² 0,024 4 pz = 1  - kg 3,2/ m² 0,08 <b>Art.0231</b> 1 pz = 1  - kg 1,3/ m² 0,024 4 pz = 1  - kg 3,2/ m² 0,08	<b>Art.0230</b> COL requirement m² 1.08 H 140 cm. COM Meterage m 0.61  <b>Art.0231</b> COL requirement m² 0.54 H 140 cm. COM Meterage m 0.61													
FIRE RETARDANT TEST														
Classe 1IM Omologazione Italia Divina MD Kvadrat. Divina Melange 3 Kvadrat. Divina 3 Kvadrat. Coated fabric Valencia Spradling.														















# Accessories

Design by Lievore Altherr Molina

<p><b>SEK ART. 0228</b></p>  <p>Stacking protection pad. For upholstered shell.</p>	<p><b>SEK ART. 0258</b></p>  <p>Link</p>	<p><b>SEK ART. 0500</b></p>  <p>Trolley (Aava 02, Catifa 46, Catifa 53, Juno 02, Mixu)</p>	<p><b>SEK ART. 0760</b></p>  <p>Trolley (finishes V03)</p>	<p><b>SEK ART. 2013</b></p>  <p>Stacking protection pad for chair with link (link is not included). For upholstered shell.</p>
666	512	4549	1560	786
<p><b>SEK ART. 2015</b></p>  <p>Set of glides (white or black) in felt</p>	<p><b>SEK ART. 2073</b></p>  <p>Movable link (not suitable for chairs with armrests)</p>			
202	48			

SHIPMENT DETAILS	TECHNICAL SPECIFICATIONS	RESISTANCE TEST
<p><b>Art. 0228</b>                      1 pz = 1  - kg 1,16/ m<sup>3</sup> 0,037                      4 pz = 1  - kg 3,12/ m<sup>3</sup> 0,037</p> <p><b>Art. 0258</b>                      1 pz = 1  - kg 0,73/ m<sup>3</sup> 0,006</p> <p><b>Art. 2013</b>                      1 pz = 1  - kg 1,6/ m<sup>3</sup> 0,037                      4 pz = 1  - kg 5,4/ m<sup>3</sup> 0,037</p> <p><b>Art. 2015</b>                      1 pz = 1  - kg 0,08/ m<sup>3</sup> 0,001                      10 pz = 1  - kg 1,2/ m<sup>3</sup> 0,007</p> <p><b>Art. 2073</b>                      1 pz = 1  - kg 1,5/ m<sup>3</sup> 0,012                      10 pz = 1  - kg 1,5/ m<sup>3</sup> 0,012                      2 pz = 1  - kg 1,5/ m<sup>3</sup> 0,012                      4 pz = 1  - kg 1,5/ m<sup>3</sup> 0,012</p>		<p>• EN 14703:2007 7.3</p> <p>• EN 14703:2007 7.2</p>
<p><b>FIRE RETARDANT TEST</b></p>		



# CATIFA UP

---

Design by  
Lievore Altherr Molina  
2017



# Catifa Up

## Collection overview

---

### Bases

---



Aluminum trestle  
swivel base  
Armrest versions



Aluminum trestle  
fixed base  
Armrest versions



5 ways  
aluminum  
Armrest versions



5 ways aluminum  
on castors  
Armrest versions

---

### Shells

---



Upholstered with a  
non-removable cover



Upholstered with  
double frontal cushion

---

### Armrest types

---



BV =  
Lacquered and polished  
armrest

The optional armrests in the same finish as the base must therefore be included when placing the order, because they can be assembled only on compatible shells.

---

# Catifa Up

Design by Lievore Altherr Molina, 2017

Chair with polished or powder-coated aluminium swivel trestle base. The shell in white polypropylene is upholstered in fabric, leather, coated fabric, fabric or customer's material. Aluminium armrests are offered in the same finishes of the base.

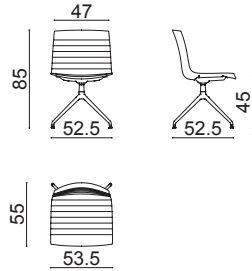

SEK ART. 6200	A	B COM	C COL	D	E	F	G	H	I	J	K	L	M	ES
POLISHED / POWDERCOATED	7799	8192	8585	8978	9371	9764	10157	10550	10943	11336	11729	12122	12515	14181
Armrests BV	+ 2071													

SHIPMENT DETAILS	TECHNICAL SPECIFICATIONS	RESISTANCE TEST
<b>Art. 6200</b> 1 pz = 2  - kg 13,9/ m³ 0,34 1 pz = 3  - kg 17,4/ m³ 0,37 4 pz = 2  - kg 41,4/ m³ 0,52 4 pz = 3  - kg 55,4/ m³ 0,55 	<b>Art.6200</b> COL requirement m² 1.86 H 140 cm. COM Meterage m 1.33	
<b>FIRE RETARDANT TEST</b> • FIRE RETARDANT VERSION WITH SURCHARGE * Classe 1IM Omologazione Italia Remix 3 Kvadrat.		

Frame Base



LU1 V12 V39  
matt matt

Armrest



Armrests BV



# Catifa Up Soft

Design by Lievore Altherr Molina, 2017

Chair with polished or powder-coated aluminium swivel trestle base. The shell in white polypropylene comes with a front double cushion and it's upholstered in leather, coated fabric, fabric or customer's material. Aluminium armrests are offered in the same finishes of the base.

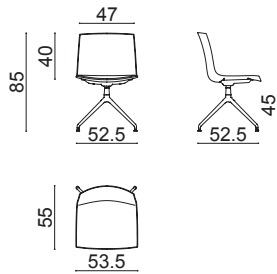

SEK ART. 6204	A	B COM	C COL	D	E	F	G	H	I	J	K	L	M	ES
POLISHED / POWDERCOATED	9799	10228	10657	11086	11515	11944	12373	12802	13231	13660	14089	14518	14947	16622
Armrests BV	+ 2071													

SHIPMENT DETAILS	TECHNICAL SPECIFICATIONS	RESISTANCE TEST
<b>Art. 6204</b> 1 pz = 2  - kg 14,9/ m³ 0,34 1 pz = 3  - kg 18,4/ m³ 0,37 4 pz = 2  - kg 43,9/ m³ 0,52 4 pz = 3  - kg 57,9/ m³ 0,55 	<b>Art.6204</b> COL requirement m² 2.40 H 140 cm. COM Meterage m 1.18	<ul style="list-style-type: none"> <li>• EN 1728:2012 - EN 16139:2013 6.10</li> <li>• EN 1728:2012 - EN 16139:2013 6.17</li> <li>• EN 1728:2012 - EN 16139:2013 6.20</li> <li>• EN 1728:2012 - EN 16139:2013 6.25</li> <li>• EN 1728:2012 - EN 16139:2013 6.4</li> <li>• EN 1728:2012 - EN 16139:2013 6.6</li> </ul> <ul style="list-style-type: none"> <li>• EN 1728:2012 - EN 16139:2013 6.11</li> <li>• EN 1728:2012 - EN 16139:2013 6.18</li> <li>• EN 1728:2012 - EN 16139:2013 6.24</li> <li>• EN 1728:2012 - EN 16139:2013 6.26</li> <li>• EN 1728:2012 - EN 16139:2013 6.5</li> </ul>
<b>FIRE RETARDANT TEST</b>		

Frame Base



Armrest



Armrests BV



# Catifa Up

Design by Lievore Altherr Molina, 2017

Chair with polished or powder-coated aluminium fixed trestle base, mounted on self-braking castors. The shell in white polypropylene is upholstered in fabric, leather, coated fabric, fabric or customer's material. Aluminium armrests are offered in the same finishes of the base.

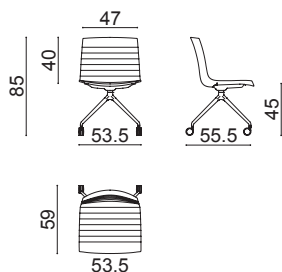

SEK ART. 6201	A	B COM	C COL	D	E	F	G	H	I	J	K	L	M	ES
POLISHED / POWDERCOATED	8204	8597	8990	9383	9776	10169	10562	10955	11348	11741	12134	12527	12920	14586
Armrests BV	+ 2071													

SHIPMENT DETAILS	TECHNICAL SPECIFICATIONS	RESISTANCE TEST
<b>Art. 6201</b> 1 pz = 2  - kg 13,9/ m³ 0,34 1 pz = 3  - kg 17,4/ m³ 0,37 4 pz = 2  - kg 41,4/ m³ 0,52 4 pz = 3  - kg 55,4/ m³ 0,55 	<b>Art.6201</b> COL requirement m² 1.86 H 140 cm. COM Meterage m 1.33	<ul style="list-style-type: none"> <li>• EN 1728:2012 - EN 16139:2013 6.10</li> <li>• EN 1728:2012 - EN 16139:2013 6.15</li> <li>• EN 1728:2012 - EN 16139:2013 6.17</li> <li>• EN 1728:2012 - EN 16139:2013 6.20</li> <li>• EN 1728:2012 - EN 16139:2013 6.25</li> <li>• EN 1728:2012 - EN 16139:2013 6.4</li> <li>• EN 1728:2012 - EN 16139:2013 6. 6</li> <li>• ANSI/BIFMA X5.1-2017/6</li> <li>• ANSI/BIFMA X5.1-2017/10</li> <li>• ANSI/BIFMA X5.1-2017/12</li> <li>• ANSI/BIFMA X5.1-2017/15</li> <li>• ANSI/BIFMA X5.1-2017/17</li> <li>• ANSI/BIFMA X5.1-2017/24</li> </ul> <ul style="list-style-type: none"> <li>• EN 1728:2012 - EN 16139:2013 6.11</li> <li>• EN 1728:2012 - EN 16139:2013 6.16</li> <li>• EN 1728:2012 - EN 16139:2013 6.18</li> <li>• EN 1728:2012 - EN 16139:2013 6.24</li> <li>• EN 1728:2012 - EN 16139:2013 6.26</li> <li>• EN 1728:2012 - EN 16139:2013 6.5</li> <li>• EN 1728:2012 - EN 16139:2013 6.13.1</li> <li>• ANSI/BIFMA X5.1-2017/7</li> <li>• ANSI/BIFMA X5.1-2017/11</li> <li>• ANSI/BIFMA X5.1-2017/13</li> <li>• ANSI/BIFMA X5.1-2017/16</li> <li>• ANSI/BIFMA X5.1-2017/20</li> <li>• ANSI/BIFMA X5.1-2017/10.4</li> </ul>
<b>FIRE RETARDANT TEST</b> • FIRE RETARDANT VERSION WITH SURCHARGE * Classe 1IM Omologazione Italia Remix 3 Kvadrat.		

Frame Base



Armrest



Armrests BV



# Catifa Up Soft

Design by Lievore Altherr Molina, 2017

Chair with polished or powder-coated aluminium fixed trestle base, mounted on self-braking castors. The shell in white polypropylene comes with a front double cushion and it's upholstered in leather, coated fabric, fabric or customer's material. Aluminium armrests are offered in the same finishes of the base.

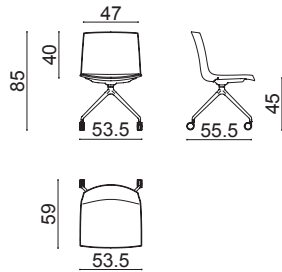

SEK ART. 6205	A	B COM	C COL	D	E	F	G	H	I	J	K	L	M	ES
POLISHED / POWDERCOATED	10204	10633	11062	11491	11920	12349	12778	13207	13636	14065	14494	14923	15352	17027
Armrests BV	+ 2071													

SHIPMENT DETAILS	TECHNICAL SPECIFICATIONS	RESISTANCE TEST
<b>Art. 6205</b> 1 pz = 2  - kg 14,9/ m³ 0,34 1 pz = 3  - kg 18,4/ m³ 0,37 4 pz = 2  - kg 43,9/ m³ 0,52 4 pz = 3  - kg 57,9/ m³ 0,55 	<b>Art.6205</b> COL requirement m² 2.40 H 140 cm. COM Meterage m 1.18	
<b>FIRE RETARDANT TEST</b>		

Frame Base



Armrest



Armrests BV



# Catifa Up

Design by Lievore Altherr Molina, 2017

Chair with polished or powder-coated aluminium five-star base, fitted with return mechanism. The shell in white polypropylene is upholstered in fabric, leather, coated fabric, fabric or customer's material. Aluminium armrests are offered in the same finishes of the base.



SEK ART. 6202	A	B COM	C COL	D	E	F	G	H	I	J	K	L	M	ES
RETURN MECHANISM	9562	9955	10348	10741	11134	11527	11920	12313	12706	13099	13492	13885	14278	15944
Armrests BV	+ 2071													

SHIPMENT DETAILS	TECHNICAL SPECIFICATIONS	RESISTANCE TEST
<b>Art. 6202</b> 1 pz = 2  - kg 16,4/ m³ 0,41 1 pz = 3  - kg 19,9/ m³ 0,44 4 pz = 5  - kg 58,6/ m³ 1,19 4 pz = 6  - kg 72,6/ m³ 1,22 	<b>Art. 6202</b> COL requirement m² 1.86 H 140 cm. COM Meterage m 1.33	<ul style="list-style-type: none"> <li>• EN 1728:2012 - EN 16139:2013 6.10</li> <li>• EN 1728:2012 - EN 16139:2013 6.11</li> <li>• EN 1728:2012 - EN 16139:2013 6.17</li> <li>• EN 1728:2012 - EN 16139:2013 6.18</li> <li>• EN 1728:2012 - EN 16139:2013 6.20</li> <li>• EN 1728:2012 - EN 16139:2013 6.24</li> <li>• EN 1728:2012 - EN 16139:2013 6.25</li> <li>• EN 1728:2012 - EN 16139:2013 6.26</li> <li>• EN 1728:2012 - EN 16139:2013 6.4</li> <li>• EN 1728:2012 - EN 16139:2013 6.5</li> <li>• EN 1728:2012 - EN 16139:2013 6.6</li> <li>• EN 1728:2012 - EN 16139:2013 6.13.1</li> </ul>
<b>FIRE RETARDANT TEST</b> • FIRE RETARDANT VERSION WITH SURCHARGE * Classe 1IM Omologazione Italia Remix 3 Kvadrat.		

Frame Base



Armrest



Armrests BV





# Catifa Up Soft

Design by Lievore Altherr Molina, 2017

Chair with polished or powder-coated aluminium five-star base, fitted with return mechanism. The shell in white polypropylene comes with a front double cushion and it's upholstered in leather, coated fabric, fabric or customer's material. Aluminium armrests are offered in the same finishes of the base.

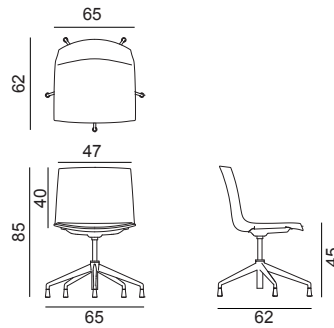

SEK ART. 6206	A	B COM	C COL	D	E	F	G	H	I	J	K	L	M	ES
RETURN MECHANISM	11562	11991	12420	12849	13278	13707	14136	14565	14994	15423	15852	16281	16710	18385
Armrests BV	+ 2071													

SHIPMENT DETAILS	TECHNICAL SPECIFICATIONS	RESISTANCE TEST
<b>Art. 6206</b> 1 pz = 2  - kg 17,4/ m³ 0,41 1 pz = 3  - kg 20,9/ m³ 0,44 4 pz = 5  - kg 61,1/ m³ 1,19 4 pz = 6  - kg 75,1/ m³ 1,22 	<b>Art.6206</b> COL requirement m² 2.40 H 140 cm. COM Meterage m 1.18	
<b>FIRE RETARDANT TEST</b>		

Frame Base



Armrest



Armrests BV



# Catifa Up

Design by Lievore Altherr Molina, 2017

Chair with polished or powder-coated aluminum five star swivel base, mounted on self-braking castors (color matching with base) and equipped with gas-lift mechanism for height adjustment. The shell in white polypropylene is upholstered in fabric, leather, coated fabric, fabric or customer's material. Aluminium armrests are offered in the same finishes of the base.

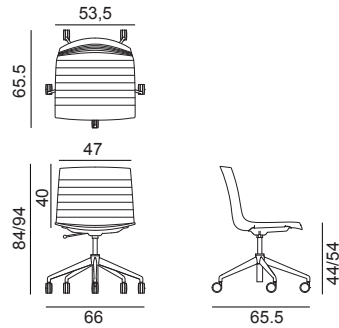

SEK ART. 6203	A	B COM	C COL	D	E	F	G	H	I	J	K	L	M	ES
GAS MECHANISM	9514	9907	10300	10693	11086	11479	11872	12265	12658	13051	13444	13837	14230	15896
Armrests BV	+ 2071													

SHIPMENT DETAILS	TECHNICAL SPECIFICATIONS	RESISTANCE TEST
<b>Art. 6203</b> 1 pz = 2  - kg 16,5/ m³ 0,41 1 pz = 3  - kg 20/ m³ 0,44 4 pz = 5  - kg 59/ m³ 1,19 4 pz = 6  - kg 73/ m³ 1,22 	<b>Art.6203</b> COL requirement m² 1.86 H 140 cm. COM Meterage m 1.33	
<b>FIRE RETARDANT TEST</b> • FIRE RETARDANT VERSION WITH SURCHARGE * Classe 1IM Omologazione Italia Remix 3 Kvadrat.		

Frame Base



LU1 V12 V39  
matt matt

Armrest



Armrests BV



# Catifa Up Soft

Design by Lievore Altherr Molina, 2017

Chair with polished or powder-coated aluminum five star swivel base, mounted on self-braking castors (color matching with base) and equipped with gas-lift mechanism for height adjustment. The shell in white polypropylene comes with a front double cushion and it's upholstered in leather, coated fabric, fabric or customer's material. Aluminium armrests are offered in the same finishes of the base.

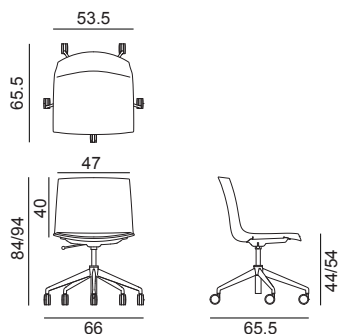

SEK ART. 6207	A	B COM	C COL	D	E	F	G	H	I	J	K	L	M	ES
GAS MECHANISM	11514	11943	12372	12801	13230	13659	14088	14517	14946	15375	15804	16233	16662	18337
Armrests BV	+ 2071													

SHIPMENT DETAILS	TECHNICAL SPECIFICATIONS	RESISTANCE TEST
<b>Art. 6207</b> 1 pz = 2  - kg 17,5/ m³ 0,41 1 pz = 3  - kg 21/ m³ 0,44 4 pz = 5  - kg 61,5/ m³ 1,19 4 pz = 6  - kg 75,5/ m³ 1,22 	<b>Art.6207</b> COL requirement m² 2.40 H 140 cm. COM Meterage m 1.18	<ul style="list-style-type: none"> <li>• EN 1728:2012 - EN 16139:2013 6.10</li> <li>• EN 1728:2012 - EN 16139:2013 6.17</li> <li>• EN 1728:2012 - EN 16139:2013 6.20</li> <li>• EN 1728:2012 - EN 16139:2013 6.25</li> <li>• EN 1728:2012 - EN 16139:2013 6.4</li> <li>• EN 1728:2012 - EN 16139:2013 6.6</li> </ul> <ul style="list-style-type: none"> <li>• EN 1728:2012 - EN 16139:2013 6.11</li> <li>• EN 1728:2012 - EN 16139:2013 6.18</li> <li>• EN 1728:2012 - EN 16139:2013 6.24</li> <li>• EN 1728:2012 - EN 16139:2013 6.26</li> <li>• EN 1728:2012 - EN 16139:2013 6.5</li> </ul>
<b>FIRE RETARDANT TEST</b>		

Frame Base



Armrest



Armrests BV



# CATIFA SENSIT

---

Design by  
Lievore Altherr Molina  
2014



# Catifa Sensit

## Collection overview

### Bases



4 ways swivel  
Optional armrests



5 ways aluminum  
Optional armrests

### Backrest



Low



Medium



High

### Options



Line stitching

### Armrest types



BI =  
Lacquered or polished



BR =  
Upholstered closed armrest

### Mechanism



Built-in self-tensioning weight  
response mechanism

# Catifa Sensit

Design by Lievore Altherr Molina, 2014

Chair with polished or powder-coated aluminum 4 way pedestal base, available in the swivel version (Art. 4901), or with return mechanism (Art. 4912). Shell with low backrest, entirely upholstered in leather, customer's leather, coated fabric, fabric or customer's fabric and fitted with self-tensioning weight response mechanism. Aluminium armrests are offered in the same finishes of the base (BI) or upholstered (BR).

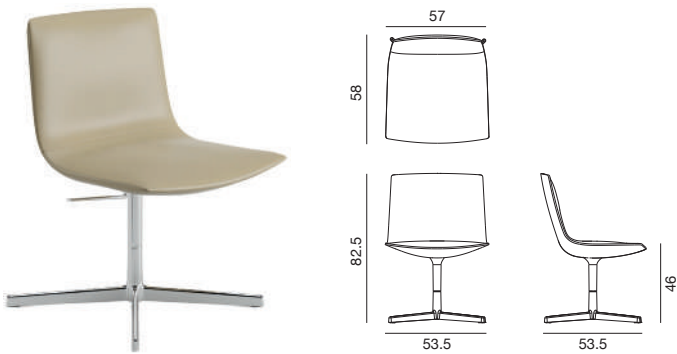

<b>SEK ART. 4901</b>	A	B COM	C COL	D	E	F	G	H	I	J	K	L	M	ES
SWIVEL BASE	14741	15217	15693	16169	16645	17121	17597	18073	18549	19025	19501	19977	20453	22338
<b>SEK ART. 4912</b>	A	B COM	C COL	D	E	F	G	H	I	J	K	L	M	ES
RETURN MECHANISM	16217	16693	17169	17645	18121	18597	19073	19549	20025	20501	20977	21453	21929	23826
	A	B COM	C COL	D	E	F	G	H	I	J	K	L	M	ES
Upholstered armrest BR	+ 2976	+ 3202	+ 3428	+ 3654	+ 3880	+ 4106	+ 4332	+ 4558	+ 4784	+ 5010	+ 5236	+ 5462	+ 5688	+ 6799
Armrest BI	+ 2405													
Lines stitching	+ 512													
Fire retardant chair + armchair BR	+ 1024													
Fire retardant chair	+ 571													

SHIPMENT DETAILS	TECHNICAL SPECIFICATIONS	RESISTANCE TEST
<b>Art. 4901</b> 1 pz = 1  - kg 23,96/ m³ 0,592 <b>Art. 4912</b> 1 pz = 1  - kg 23,96/ m³ 0,592	<b>Art.4901</b> COL requirement m² COL requirement m² 1.98 Armrests BR: COL requirement m² 1.14 H 140 cm. COM Meterage m H 140 cm. COM Meterage ml 1.38 Armrests BR: H 140 cm. COM Meterage ml 1.16  <b>Art.4912</b> COL requirement m² COL requirement m² 1.98 Armrests BR: COL requirement m² 1.14 H 140 cm. COM Meterage m H 140 cm. COM Meterage ml 1.38 Armrests BR: H 140 cm. COM Meterage ml 1.16	
<b>FIRE RETARDANT TEST</b>		
Classe 1IM Omologazione Italia Elmosoft.		

Frame Base



LU1 V39  
matt

Armrest



Armrest BI

Upholstered armrest BR



All other types of floor

Wooden floor

Carpets



# Catifa Sensit

Design by Lievore Altherr Molina, 2014

Chair with polished or powder-coated aluminum 4 way pedestal base, available in the swivel version (Art. 4903), or with return mechanism (Art. 4913). Shell with medium backrest, entirely upholstered in leather, customer's leather, coated fabric, fabric or customer's fabric and fitted with self-tensioning weight response mechanism. Aluminium armrests are offered in the same finishes of the base (BI) or upholstered (BR).

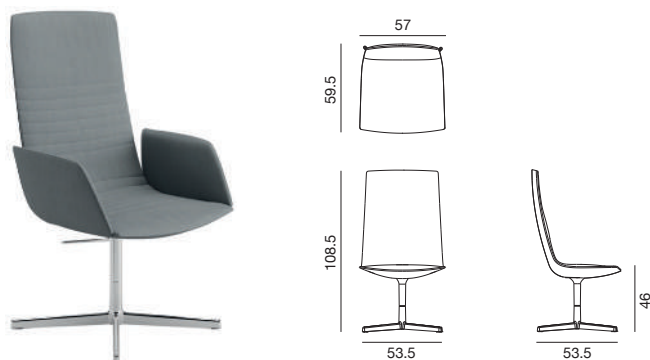

<b>SEK ART. 4903</b>	A	B	COM	C	COL	D	E	F	G	H	I	J	K	L	M	ES
SWIVEL BASE	15622	16217	16812	17407	18002	18597	19192	19787	20382	20977	21572	22167	22762	23357	23952	24547
<b>SEK ART. 4913</b>	A	B	COM	C	COL	D	E	F	G	H	I	J	K	L	M	ES
RETURN MECHANISM	17122	17717	18312	18907	19502	20097	20692	21287	21882	22477	23072	23667	24262	24857	25452	26047
	A	B	COM	C	COL	D	E	F	G	H	I	J	K	L	M	ES
Upholstered armrest BR	+ 2976	+ 3202	+ 3428	+ 3654	+ 3880	+ 4106	+ 4332	+ 4558	+ 4784	+ 5010	+ 5236	+ 5462	+ 5688	+ 5914	+ 6140	+ 6366
Armrest BI	+ 2405															
Lines stitching	+ 512															
Fire retardant chair + armchair BR	+ 1024															
Fire retardant chair	+ 571															

SHIPMENT DETAILS	TECHNICAL SPECIFICATIONS	RESISTANCE TEST
<b>Art. 4903</b> 1 pz = 1  - kg 30,45/ m³ 0,734 <b>Art. 4913</b> 1 pz = 1  - kg 30,45/ m³ 0,734	<b>Art.4903</b> COL requirement m² COL requirement m² 2.76 Armrests BR: COL requirement m² 1.14 H 140 cm. COM Meterage m H 140 cm. COM Meterage ml 1.59 Armrests BR: H 140 cm. COM Meterage ml 1.16  <b>Art.4913</b> COL requirement m² COL requirement m² 2.76 Armrests BR: COL requirement m² 1.14 H 140 cm. COM Meterage m H 140 cm. COM Meterage ml 1.58 Armrests BR: H 140 cm. COM Meterage ml 1.16	
<b>FIRE RETARDANT TEST</b> Classe 1IM Omologazione Italia Elmosoft.		

Frame Base



LU1 V39  
matt

Armrest



Armrest BI

Upholstered armrest BR



All other types of floor Wooden floor Carpets



# Catifa Sensit

Design by Lievore Altherr Molina, 2014

Chair with polished or powder-coated aluminum 4 way pedestal base, available in the swivel version (Art. 4906), or with return mechanism (Art. 4914). Shell with high backrest, entirely upholstered in leather, customer's leather, coated fabric, fabric or customer's fabric and fitted with self-tensioning weight response mechanism. Aluminium armrests are offered in the same finishes of the base (BI) or upholstered (BR).

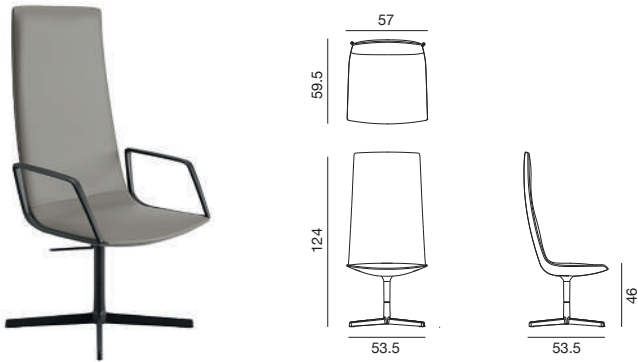

<b>SEK ART. 4906</b>	A	B COM	C COL	D	E	F	G	H	I	J	K	L	M	ES
SWIVEL BASE	16729	17456	18183	18910	19637	20364	21091	21818	22545	23272	23999	24726	25453	28375
<b>SEK ART. 4914</b>	A	B COM	C COL	D	E	F	G	H	I	J	K	L	M	ES
RETURN MECHANISM	18206	18933	19660	20387	21114	21841	22568	23295	24022	24749	25476	26203	26930	29875
	A	B COM	C COL	D	E	F	G	H	I	J	K	L	M	ES
Upholstered armrest BR	+ 2976	+ 3202	+ 3428	+ 3654	+ 3880	+ 4106	+ 4332	+ 4558	+ 4784	+ 5010	+ 5236	+ 5462	+ 5688	+ 6799
Armrest BI	+ 2405													
Lines stitching	+ 512													
Fire retardant chair + armchair BR	+ 1024													
Fire retardant chair	+ 571													

SHIPMENT DETAILS	TECHNICAL SPECIFICATIONS	RESISTANCE TEST
<b>Art. 4906</b> 1 pz = 1  - kg 33/ m³ 0,853 <b>Art. 4914</b> 1 pz = 1  - kg 32/ m³ 0,852	<b>Art.4906</b> COL requirement m² COL requirement m² 3.18 Armrests BR: COL requirement m² 1.14 H 140 cm. COM Meterage m H 140 cm. COM Meterage ml 1.76 Armrests BR: H 140 cm. COM Meterage ml 1.16  <b>Art.4914</b> COL requirement m² COL requirement m² 3.18 Armrests BR: COL requirement m² 1.14 H 140 cm. COM Meterage m H 140 cm. COM Meterage ml 1.76 Armrests BR: H 140 cm. COM Meterage ml 1.16	
<b>FIRE RETARDANT TEST</b>		
Classe 1IM Omologazione Italia Elmosoft.		

Frame Base

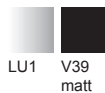

Armrest





# Catifa Sensit

Design by Lievore Altherr Molina, 2014

Chair with polished or powder-coated aluminum 5 way swivel base on castors, fitted with gas-lift mechanism for height adjustment. Shell with low backrest, entirely upholstered in leather, customer's leather, coated fabric, fabric or customer's fabric and fitted with self-tensioning weight response mechanism. Aluminium armrests are offered in the same finishes of the base (BI) or upholstered (BR).

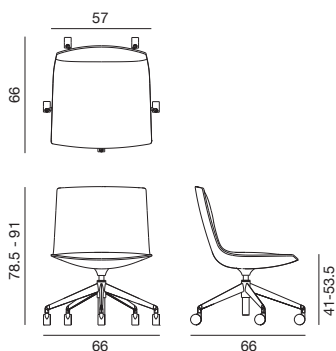

SEK ART. 4900	A	B COM	C COL	D	E	F	G	H	I	J	K	L	M	ES
POLISHED ALUMINIUM / POWDERCOATED	16003	16479	16955	17431	17907	18383	18859	19335	19811	20287	20763	21239	21715	23648
	A	B COM	C COL	D	E	F	G	H	I	J	K	L	M	ES
Upholstered armrest BR	+ 2976	+ 3202	+ 3428	+ 3654	+ 3880	+ 4106	+ 4332	+ 4558	+ 4784	+ 5010	+ 5236	+ 5462	+ 5688	+ 6799
Armrest BI	+ 2405													
Lines stitching	+ 512													
Fire retardant chair + armchair BR	+ 1024													
Fire retardant chair	+ 571													

SHIPMENT DETAILS	TECHNICAL SPECIFICATIONS	RESISTANCE TEST
<b>Art. 4900</b> 1 pz = 1  - kg 23,96/ m² 0,592	<b>Art.4900</b> COL requirement m² COL requirement m² 1.98 Armrests BR: COL requirement m² 1.14 H 140 cm. COM Meterage m H 140 cm. COM Meterage ml 1.38 Armrests BR: H 140 cm. COM Meterage ml 1.16	
<b>FIRE RETARDANT TEST</b> Classe 1IM Omologazione Italia Elmosoft.		

Frame Base



LU1 V39  
matt

Armrest



Armrest BI



Upholstered armrest BR



# Catifa Sensit

Design by Lievore Altherr Molina, 2014

Chair with polished or powder-coated aluminum 5 way swivel base on castors, fitted with gas-lift mechanism for height adjustment. Shell with medium backrest, entirely upholstered in leather, customer's leather, coated fabric, fabric or customer's fabric and fitted with self-tensioning weight response mechanism. Aluminium armrests are offered in the same finishes of the base (BI) or upholstered (BR).

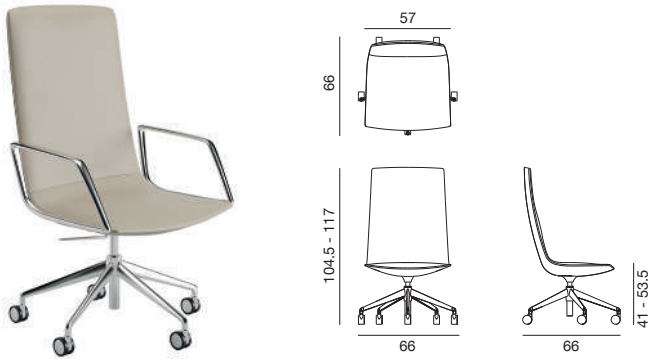

<b>SEK ART. 4902</b>	A	B COM	C COL	D	E	F	G	H	I	J	K	L	M	ES
POLISHED ALUMINIUM / POWDERCOATED	16920	17515	18110	18705	19300	19895	20490	21085	21680	22275	22870	23465	24060	26446
	A	B COM	C COL	D	E	F	G	H	I	J	K	L	M	ES
Upholstered armrest BR	+ 2976	+ 3202	+ 3428	+ 3654	+ 3880	+ 4106	+ 4332	+ 4558	+ 4784	+ 5010	+ 5236	+ 5462	+ 5688	+ 6799
Armrest BI	+ 2405													
Lines stitching	+ 512													
Fire retardant chair + armchair BR	+ 1024													
Fire retardant chair	+ 571													

SHIPMENT DETAILS	TECHNICAL SPECIFICATIONS	RESISTANCE TEST
<b>Art. 4902</b> 1 pz = 1  - kg 30,45/ m² 0,734	<b>Art.4902</b> COL requirement m² COL requirement m² 2.76 Armrests BR: COL requirement m² 1.14 H 140 cm. COM Meterage m H 140 cm. COM Meterage ml 1.58 Armrests BR: H 140 cm. COM Meterage ml 1.16	<ul style="list-style-type: none"> <li>• EN 1728:2012 - EN 16139:2013 6.10</li> <li>• EN 1728:2012 - EN 16139:2013 6.17</li> <li>• EN 1728:2012 - EN 16139:2013 6.20</li> <li>• EN 1728:2012 - EN 16139:2013 6.25</li> <li>• EN 1728:2012 - EN 16139:2013 6.4</li> </ul> <ul style="list-style-type: none"> <li>• EN 1728:2012 - EN 16139:2013 6.11</li> <li>• EN 1728:2012 - EN 16139:2013 6.18</li> <li>• EN 1728:2012 - EN 16139:2013 6.24</li> <li>• EN 1728:2012 - EN 16139:2013 6.26</li> <li>• EN 1728:2012 - EN 16139:2013 6.5</li> </ul>
<b>FIRE RETARDANT TEST</b> Classe 1IM Omologazione Italia Elmosoft.		

Frame Base

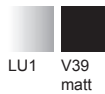

Armrest



# Catifa Sensit

Design by Lievore Altherr Molina, 2014

Chair with polished or powder-coated aluminum 5 way swivel base on castors, fitted with gas-lift mechanism for height adjustment. Shell with high backrest, entirely upholstered in leather, customer's leather, coated fabric, fabric or customer's fabric and fitted with self-tensioning weight response mechanism. Aluminium armrests are offered in the same finishes of the base (BI) or upholstered (BR).

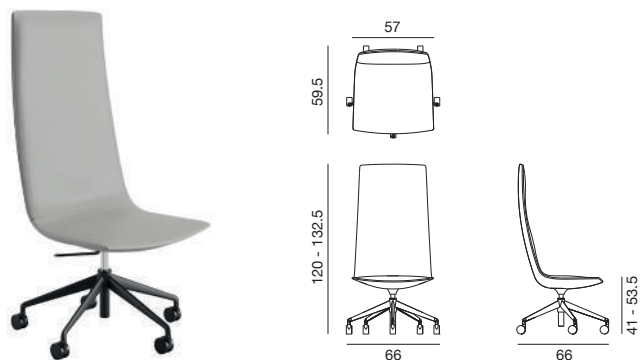

<b>SEK ART. 4905</b>	A	B COM	C COL	D	E	F	G	H	I	J	K	L	M	ES
POLISHED ALUMINIUM / POWDERCOATED	17992	18719	19446	20173	20900	21627	22354	23081	23808	24535	25262	25989	26716	29684
	A	B COM	C COL	D	E	F	G	H	I	J	K	L	M	ES
Upholstered armrest BR	+ 2976	+ 3202	+ 3428	+ 3654	+ 3880	+ 4106	+ 4332	+ 4558	+ 4784	+ 5010	+ 5236	+ 5462	+ 5688	+ 6799
Armrest BI	+ 2405													
Lines stitching	+ 512													
Fire retardant chair + armchair BR	+ 1024													
Fire retardant chair	+ 571													

SHIPMENT DETAILS	TECHNICAL SPECIFICATIONS	RESISTANCE TEST
<b>Art. 4905</b> 1 pz = 1  - kg 33/ m³ 0,853	<b>Art.4905</b> COL requirement m² COL requirement m² 3.18 Armrests BR: COL requirement m² 1.14 H 140 cm. COM Meterage m H 140 cm. COM Meterage ml 1.76 Armrests BR: H 140 cm. COM Meterage ml 1.16	
<b>FIRE RETARDANT TEST</b> Classe 1IM Omologazione Italia Elmosoft.		

Frame Base

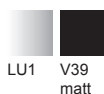

Armrest



Armrest BI

Upholstered armrest BR



# CATIFA 60

---

Design by  
Lievore Altherr Molina  
2008



# Catifa 60

## Collection overview

---

### Bases



Lounge sled



Lounge 4 ways

---

### Options

#### Seams



Standard option



Horizontal stitching

---

#### Armrest types



CI =  
Upholstered aluminum armrest

#### Return mechanism



# Catifa 60 Lounge

Design by Lievore Altherr Molina, 2008

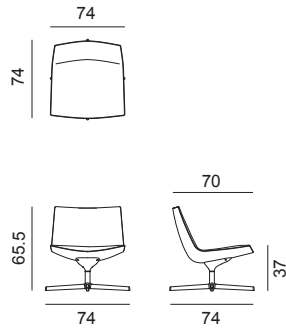

Lounge chair with polished or powdercoated aluminium pedestal base and low backrest, available in the swivel version (Art. 2139) or with return mechanism (Art. 2140). The polyurethane shell is upholstered in leather, coated fabric, fabric or customer's material. Aluminium armrests are offered in the same finishes of the base, also in upholstered version.

SEK ART. 2139	A	B COM	C COL	D	E	F	G	H	I	J	K	L	M	ES
SWIVEL BASE	13181	13657	14133	14609	15085	15561	16037	16513	16989	17465	17941	18417	18893	20658
SEK ART. 2140	A	B COM	C COL	D	E	F	G	H	I	J	K	L	M	ES
RETURN MECHANISM	14658	15134	15610	16086	16562	17038	17514	17990	18466	18942	19418	19894	20370	22148
Armrests CI	+ 2036													
Line stitching	+ 512													
Fire retardant foam	+ 666													

SHIPMENT DETAILS	TECHNICAL SPECIFICATIONS	RESISTANCE TEST
<b>Art.2139</b> 1 pz = 1  - kg 23,96/ m² 0,51 <b>Art.2140</b> 1 pz = 1  - kg 23,96/ m² 0,508 1 pz = 1  - kg 26,54/ m² 0,508	<b>Art.2139</b> COL requirement m² 2.76 H 140 cm. COM Meterage m 1.82 <b>Art.2140</b> COL requirement m² 2.76 H 140 cm. COM Meterage m 1.82	<ul style="list-style-type: none"> <li>• EN 1728:2012 - EN 16139:2013 6.10</li> <li>• EN 1728:2012 - EN 16139:2013 6.17</li> <li>• EN 1728:2012 - EN 16139:2013 6.20</li> <li>• EN 1728:2012 - EN 16139:2013 6.25</li> <li>• EN 1728:2012 - EN 16139:2013 6.4</li> </ul> <ul style="list-style-type: none"> <li>• EN 1728:2012 - EN 16139:2013 6.11</li> <li>• EN 1728:2012 - EN 16139:2013 6.18</li> <li>• EN 1728:2012 - EN 16139:2013 6.24</li> <li>• EN 1728:2012 - EN 16139:2013 6.26</li> <li>• EN 1728:2012 - EN 16139:2013 6.5</li> </ul>

## FIRE RETARDANT TEST

Classe 1IM Omologazione Italia Divina MD Kvadrat. Divina Melange 3 Kvadrat. Divina 3 Kvadrat. Elmosoft. Field Kvadrat. Hallingdal 65 Kvadrat. Elmo Neocoast. Remix 3 Kvadrat. Steelcut Trio 3 Kvadrat. Tonus 4 Kvadrat. Coated fabric Valencia Spradling.

## Frame Base

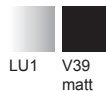

## Armrest



Armrests CI



Line stitching



All other types of floor



Wooden floor



Carpets



# Catifa 60 Lounge

Design by Lievore Altherr Molina, 2008

Lounge armchair with chromed or powdercoated steel sled base and low backrest. The polyurethane shell is upholstered in leather, coated fabric, fabric or customer's material. Glides for wooden floors available upon request.

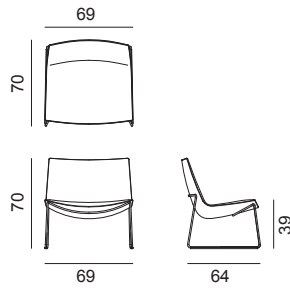

SEK ART. 2141	A	B COM	C COL	D	E	F	G	H	I	J	K	L	M	ES
CHROMED	12050	12526	13002	13478	13954	14430	14906	15382	15858	16334	16810	17286	17762	19527

SHIPMENT DETAILS	TECHNICAL SPECIFICATIONS	RESISTANCE TEST
<b>Art.2141</b> 1 pz = 1  - kg 25,96/ m² 0,508	<b>Art.2141</b> COL requirement m² 2.76 H 140 cm. COM Meterage m 1.82	

**FIRE RETARDANT TEST**  
 Classe 1IM Omologazione Italia Divina MD Kvadrat. Divina Melange 3 Kvadrat. Divina 3 Kvadrat. Elmosoft. Field Kvadrat. Hallingdal 65 Kvadrat. Elmo Neocoast. Remix 3 Kvadrat. Steelcut Trio 3 Kvadrat. Tonus 4 Kvadrat. Coated fabric Valencia Spradling.

Frame Base



Line stitching



Standard: polycarbonate glide with polyurethane insert.



Upon request: polycarbonate glide with felt insert.



# CATIFA 70

---

Design by  
Lievore Altherr Molina  
2006





# Catifa 70

## Collection overview

---

### Bases



4 ways  
Options:  
— Armrest

4 ways footrest

---

### Shells



Upholstered and covered



Soft

---

### Options

#### Armrest types



LU1 =  
Aluminum armrest



CI =  
Upholstered aluminum armrest

---

#### Return and Tilt mechanism



# Catifa 70

Design by Lievore Altherr Molina, 2006

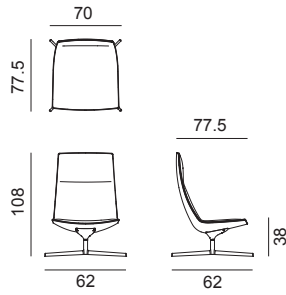

Lounge chair with polished or powdercoated aluminium pedestal base, available in the swivel version (Art. 2007) or with return mechanism (Art. 2035). The polyurethane shell is upholstered in leather, coated fabric, fabric or customer's material. Aluminium armrests are offered in the same finishes of the base, also in upholstered version.

SEK ART. 2007	A	B COM	C COL	D	E	F	G	H	I	J	K	L	M	ES
SWIVEL BASE	14812	15836	16860	17884	18908	19932	20956	21980	23004	24028	25052	26076	27100	29768
SEK ART. 2035	A	B COM	C COL	D	E	F	G	H	I	J	K	L	M	ES
RETURN MECHANISM	16324	17348	18372	19396	20420	21444	22468	23492	24516	25540	26564	27588	28612	31304
Armrests CI	+ 2310													
Fire retardant foam	+ 881													
SHIPMENT DETAILS	TECHNICAL SPECIFICATIONS				RESISTANCE TEST									
<b>Art.2007</b> 1 pz = 1  - kg 36/ m³ 0,955 1 pz = 1  - kg 40/ m³ 0,955 <b>Art.2035</b> 1 pz = 1  - kg 36/ m³ 0,955 1 pz = 1  - kg 40/ m³ 0,955	<b>Art.2007</b> COL requirement m² 3.86 H 140 cm. COM Meterage m 2.7 <b>Art.2035</b> COL requirement m² 3.86 H 140 cm. COM Meterage m 2.7													
FIRE RETARDANT TEST														
Classe 1IM Omologazione Italia Divina MD Kvadrat. Divina Melange 3 Kvadrat. Divina 3 Kvadrat. Elmosoft. Field Kvadrat. Hallingdal 65 Kvadrat. Elmo Neocoast. Remix 3 Kvadrat. Steelcut Trio 3 Kvadrat. Tonus 4 Kvadrat. Coated fabric Valencia Spradling.														

## Frame Base

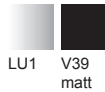

## Armrest



Armrests CI



All other types of floor Wooden floor Carpets



# Catifa 70

Design by Lievore Altherr Molina, 2006

Footstool with polished or powder-coated aluminium pedestal base and polyurethane shell upholstered in leather, coated fabric, fabric or customer's material.

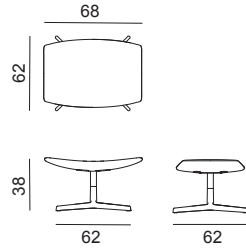

SEK ART. 2008	A	B COM	C COL	D	E	F	G	H	I	J	K	L	M	ES
POLISHED	8644	8906	9168	9430	9692	9954	10216	10478	10740	11002	11264	11526	11788	17253
Fire retardant foam	+ 417													

SHIPMENT DETAILS	TECHNICAL SPECIFICATIONS	RESISTANCE TEST
<b>Art.2008</b> 1 pz = 1  - kg 15/ m³ 0,196	<b>Art.2008</b> COL requirement m² 1.68 H 140 cm. COM Meterage m 0.94	

**FIRE RETARDANT TEST**  
 Classe 1IM Omologazione Italia Divina MD Kvadrat. Divina Melange 3 Kvadrat. Divina 3 Kvadrat. Elmosoft. Field Kvadrat. Hallingdal 65 Kvadrat. Elmo Neocoast. Remix 3 Kvadrat. Steelcut Trio 3 Kvadrat. Tonus 4 Kvadrat. Coated fabric Valencia Spradling.

Frame Base



All other types of floor    Wooden floor    Carpets



# Catifa 70 Soft

Design by Lievore Altherr Molina, 2012

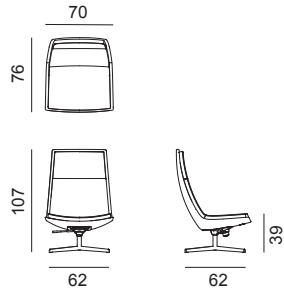

Lounge chair with polished or powdercoated aluminium pedestal base equipped with return and tilt mechanisms. Structural polyurethane upholstered shell and cushions (with removable covers) in leather, coated fabric, fabric or customer's material. Aluminium armrests are offered in the same finishes of the base, also in upholstered version.

Accessories:  
Replacement cover set Art. 3303

SEK ART. 3300	A	B COM	C COL	D	E	F	G	H	I	J	K	L	M	ES
RETURN AND TILT MECHANISM	24802	25980	27158	28336	29514	30692	31870	33048	34226	35404	36582	37760	38938	43640
Armrest LU1 /Armrest Cl	+ 2310													
SHIPMENT DETAILS	TECHNICAL SPECIFICATIONS				RESISTANCE TEST									
<b>Art.3300</b> 1 pz = 1  - kg 38/ m² 0,955 1 pz = 1  - kg 41/ m² 0,955	<b>Art.3300</b> COL requirement m² 5.52 H 140 cm. COM Meterage m 3.52													
FIRE RETARDANT TEST														

Frame Base



Armrest



Armrest LU1 /Armrest Cl



Tilt mechanism (standard colour grey)



All other types of floor



Wooden floor



Carpets



# Catifa 70 Soft

Design by Lievore Altherr Molina, 2012

Footstool with polished aluminium or powercoated pedestal base and structural polyurethane shell with upholstered cushion (with removable cover) in leather, coated fabric, fabric or customer's material.

Accessories:  
Replacement cover set Art. 3304

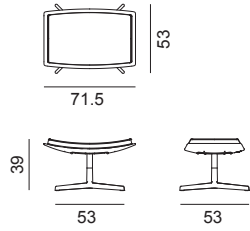

SEK ART. 3302	A	B COM	C COL	D	E	F	G	H	I	J	K	L	M	ES
POLISHED	11859	12276	12693	13110	13527	13944	14361	14778	15195	15612	16029	16446	16863	18622
<b>SHIPMENT DETAILS</b>	<b>TECHNICAL SPECIFICATIONS</b>				<b>RESISTANCE TEST</b>									
Art.3302 1 pz = 1  - kg 15/ m³ 0,196	Art.3302 COL requirement m² 2.28 H 140 cm. COM Meterage m 1.87													
<b>FIRE RETARDANT TEST</b>														

Frame Base

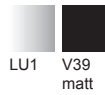

# Catifa 70 Soft

Design by Lievore Altherr Molina, 2012

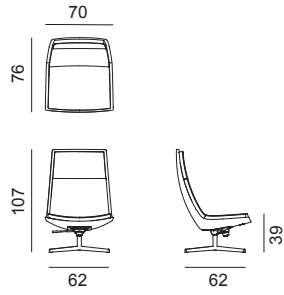

SEK ART. 3303	A	B COM	C COL	D	E	F	G	H	I	J	K	L	M	ES
SPARE COVER	2739	3346	3953	4560	5167	5774	6381	6988	7595	8202	8809	9416	10023	13872
SEK ART. 3304	A	B COM	C COL	D	E	F	G	H	I	J	K	L	M	ES
COVER	1358	1609	1860	2111	2362	2613	2864	3115	3366	3617	3868	4119	4370	5549

SHIPMENT DETAILS	TECHNICAL SPECIFICATIONS	RESISTANCE TEST
<b>Art.3303</b> 1 pz = 1  - kg 5/ m³ 0,196 <b>Art.3304</b> 1 pz = 1  - kg 5/ m³ 0,196	<b>Art.3303</b> COL requirement m² 3.06 H 140 cm. COM Meterage m 1.84 <b>Art.3304</b> COL requirement m² 1.15 H 140 cm. COM Meterage m 1.05	

### FIRE RETARDANT TEST

Classe 1IM Omologazione Italia Divina MD Kvadrat. Divina Melange 3 Kvadrat. Divina 3 Kvadrat. Elmosoft. Hallingdal 65 Kvadrat. Remix 3 Kvadrat. Steelcut Trio 3 Kvadrat. Tonus 4 Kvadrat. Coated fabric Valencia Spradling.

Frame Base



V39  
matt





# CATIFA 80

---

Design by  
Lievore Altherr Molina  
2006





# Catifa 80

## Collection overview

---

### Bases



4 ways



Sled

---

# Catifa 80

Design by Lievore Altherr Molina, 2006

Lounge chair with polished or powder-coated aluminium pedestal base, available in the swivel version (Art. 2009) or with return mechanism (Art. 2028) The polyurethane shell is upholstered in leather, coated fabric, fabric or customer's material.

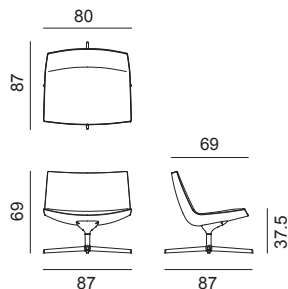

SEK ART. 2009	A	B COM	C COL	D	E	F	G	H	I	J	K	L	M	ES
SWIVEL BASE	13538	14348	15158	15968	16778	17588	18398	19208	20018	20828	21638	22448	23258	26529
SEK ART. 2028	A	B COM	C COL	D	E	F	G	H	I	J	K	L	M	ES
RETURN MECHANISM	15039	15849	16659	17469	18279	19089	19899	20709	21519	22329	23139	23949	24759	28017
Fire retardant foam	+ 643													

SHIPMENT DETAILS	TECHNICAL SPECIFICATIONS	RESISTANCE TEST
<b>Art.2009</b> 1 pz = 1  - kg 26,54/ m³ 0,588 <b>Art.2028</b> 1 pz = 1  - kg 26,1/ m³ 0,596	<b>Art.2009</b> COL requirement m² 3.14 H 140 cm. COM Meterage m 2.37 <b>Art.2028</b> COL requirement m² 3.14 H 140 cm. COM Meterage m 2.37	

**FIRE RETARDANT TEST**  
 Classe 1IM Omologazione Italia Divina MD Kvadrat. Divina Melange 3 Kvadrat. Divina 3 Kvadrat. Elmosoft. Field Kvadrat. Hallingdal 65 Kvadrat. Elmo Neocoast. Remix 3 Kvadrat. Steelcut Trio 3 Kvadrat. Tonus 4 Kvadrat. Coated fabric Valencia Spradling.

Frame Base



All other types of floor Wooden floor Carpets



# Catifa 80

Design by Lievore Altherr Molina, 2006

Lounge chair with chromed or powdercoated steel sled base and polyurethane shell upholstered in leather, coated fabric, fabric or customer's material. Glides for wooden floors available upon request.

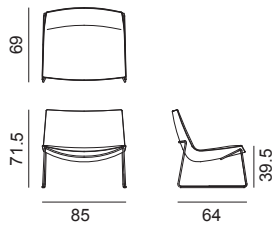

SEK ART. 2010	A	B COM	C COL	D	E	F	G	H	I	J	K	L	M	ES
CHROMED	12561	13371	14181	14991	15801	16611	17421	18231	19041	19851	20661	21471	22281	25541
Fire retardant foam	+ 643													

SHIPMENT DETAILS	TECHNICAL SPECIFICATIONS	RESISTANCE TEST
<b>Art.2010</b> 1 pz = 1  - kg 25,52/ m² 0,588	<b>Art.2010</b> COL requirement m² 3.14 H 140 cm. COM Meterage m 2.37	

**FIRE RETARDANT TEST**  
 Classe 1IM Omologazione Italia Divina MD Kvadrat. Divina Melange 3 Kvadrat. Divina 3 Kvadrat. Elmosoft. Field Kvadrat. Hallingdal 65 Kvadrat. Elmo Neocoast. Remix 3 Kvadrat. Steelcut Trio 3 Kvadrat. Tonus 4 Kvadrat. Coated fabric Valencia Spradling.

## Frame Base



Standard: polycarbonate glide with polyurethane insert.



Upon request: polycarbonate glide with felt insert.



# CILA

---

Design by  
Lievore Altherr  
2017



# Cila

## Collection overview

### Bases



4 legs



4 wood legs



Sled



Aluminium trestle swivel base



Steel trestle fixed

### Shell

#### Chair version



Polypropylene



Polypropylene with seat cushion



Upholstered with non-removable cover

#### Armchair version



Polypropylene



Polypropylene with seat cushion



Upholstered with non-removable cover

# Cila

Design by Lievore Altherr, 2017

Chair with chromed or powdercoated steel 4-leg base.  
Polypropylene shell available in five colors. Optional glides with felt for wooden floors are available upon request.

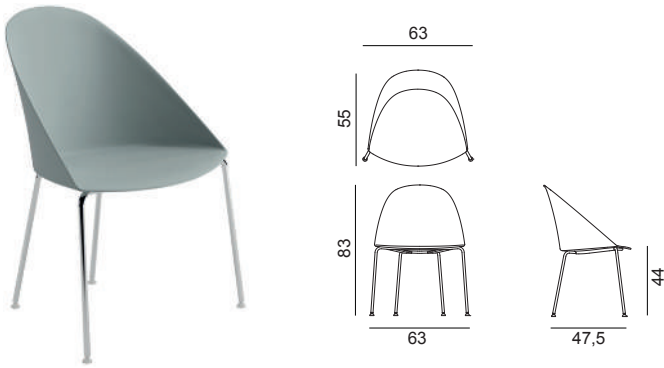

<b>SEK ART. 2200</b>	PC	
CHROMED / POWDERCOATED	2345	
<b>SHIPMENT DETAILS</b>	<b>TECHNICAL SPECIFICATIONS</b>	<b>RESISTANCE TEST</b>
<b>Art.2200</b> 1 pz = 2  - kg 9,81/ m³ 0,298 4 pz = 2  - kg 28,83/ m³ 0,426	<b>Art.2200</b> *Classe 1, 2, 11M: fire retardant version available with surcharge and eventual minimum batch	<ul style="list-style-type: none"> <li>• EN 1728:2012 - EN 16139:2013 6.17</li> <li>• EN 1728:2012 - EN 16139:2013 6.4</li> <li>• TUV GS (EN16139)</li> <li>• EN 1728:2012 - EN 16139:2013 6.18</li> <li>• EN 1728:2012 - EN 16139:2013 6.5</li> <li>• EN 1728:2012 - EN 16139:2013 6. 6</li> </ul>
<b>FIRE RETARDANT TEST</b>		
• FIRE RETARDANT VERSION WITH SURCHARGE * Classe 2 Omologazione Italia Polipropilene.		

## Frame Base



## Shell



# Cila

Design by Lievore Altherr, 2017

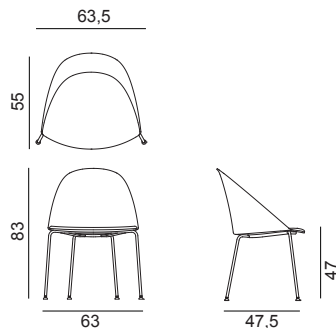

Chair with four-leg base made of chromed or powdercoated steel. Polypropylene shell available in five colours, with seat cushion in leather, coated fabric, fabric or customer's own material. Optional glides with felt for wooden floors are available upon request.

SEK ART. 2201	A	B COM	C COL	D	E	F	G	H	I	J	K	L	M	ES
CHROMED / POWDERCOATED	3334	3429	3524	3619	3714	3809	3904	3999	4094	4189	4284	4379	4474	4905
<b>SHIPMENT DETAILS</b>		<b>TECHNICAL SPECIFICATIONS</b>				<b>RESISTANCE TEST</b>								
<b>Art.2201</b> 1 pz = 2  - kg 11,99/ m³ 0,337 4 pz = 2  - kg 33,67/ m³ 0,501		<b>Art.2201</b> COL requirement m² 0.756 H 140 cm. COM Meterage m 0.41				<ul style="list-style-type: none"> <li>TUV GS (EN16139)</li> </ul>								
<b>FIRE RETARDANT TEST</b>														
Classe 1IM Omologazione Italia Elmo Neocoast. Remix 3 Kvadrat. Steelcut 2 Kvadrat. Steelcut Trio 3 Kvadrat. Coated fabric Valencia Spradling.														

## Frame Base



## Shell



# Cila

Design by Lievore Altherr, 2017

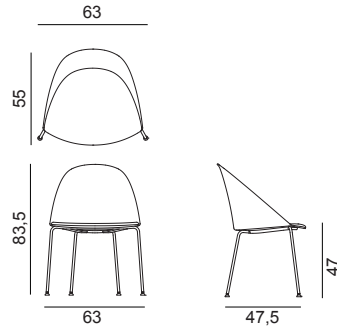

Chair with four-leg base made of chromed or powdercoated steel. Shell fully upholstered in leather, coated fabric, fabric or customer's own material. Optional glides with felt for wooden floors are available upon request.

SEK ART. 2203	A	B COM	C COL	D	E	F	G	H	I	J	K	L	M	ES
CHROMED / POWDERCOATED	5346	5656	5966	6276	6586	6896	7206	7516	7826	8136	8446	8756	9066	10513
<b>SHIPMENT DETAILS</b>	<b>TECHNICAL SPECIFICATIONS</b>				<b>RESISTANCE TEST</b>									
<b>Art.2203</b> 1 pz = 2  - kg 12,49/ m² 0,337 4 pz = 2  - kg 35,67/ m² 0,501	<b>Art.2203</b> COL requirement m² 3 H 140 cm. COM Meterage m 1.31 *Classe 1, 2, 1IM: fire retardant version available with surcharge and eventual minimum batch				• TUV GS (EN16139)									
<b>FIRE RETARDANT TEST</b> Classe 1IM Omologazione Italia Remix 3 Kvadrat. Steelcut 2 Kvadrat. • FIRE RETARDANT VERSION WITH SURCHARGE * Classe 1IM Omologazione Italia Steelcut Trio 3 Kvadrat. Coated fabric Valencia Spradling.														

## Frame Base





# Cila

Design by Lievore Altherr, 2018

Armchair with four-leg base made of chromed or powdercoated steel. Polypropylene shell available in 5 colours. Optional glides with felt for wooden floors are available upon request.

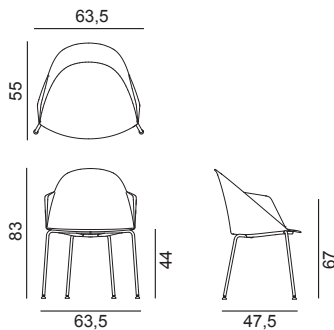

<b>SEK ART. 2220</b>	PC	
CHROMED / POWDERCOATED	2703	
<b>SHIPMENT DETAILS</b>	<b>TECHNICAL SPECIFICATIONS</b>	<b>RESISTANCE TEST</b>
<b>Art.2220</b> 1 pz = 2  - kg 10,25/ m³ 0,32 4 pz = 2  - kg 29,89/ m³ 0,451	<b>Art.2220</b> *Classe 1, 2, 11M: fire retardant version available with surcharge and eventual minimum batch	<ul style="list-style-type: none"> <li>TUV GS (EN16139)</li> </ul>
<b>FIRE RETARDANT TEST</b>		
* FIRE RETARDANT VERSION WITH SURCHARGE * Classe 2 Omologazione Italia Polipropilene.		

## Frame Base



## Shell



# Cila

Design by Lievore Altherr, 2018

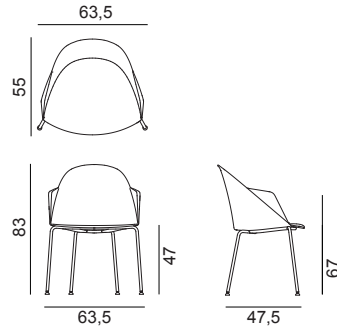

Armchair with four-leg base made of chromed or powdercoated steel. Polypropylene shell available in 5 colours, with seat cushion in fabric, leather, coated fabric, or customer's material. Optional glides with felt for wooden floors are available upon request.

SEK ART. 2221	A	B COM	C COL	D	E	F	G	H	I	J	K	L	M	ES
CHROMED / POWDERCOATED	3679	3774	3869	3964	4059	4154	4249	4344	4439	4534	4629	4724	4819	5263
<b>SHIPMENT DETAILS</b>		<b>TECHNICAL SPECIFICATIONS</b>				<b>RESISTANCE TEST</b>								
<b>Art.2221</b> 1 pz = 2  - kg 12,16/ m² 0,398 4 pz = 2  - kg 35,17/ m² 0,564		<b>Art.2221</b> COL requirement m² 0.756 H 140 cm. COM Meterage m 0.41				<ul style="list-style-type: none"> <li>TUV GS (EN16139)</li> </ul>								
<b>FIRE RETARDANT TEST</b>														
Classe 1IM Omologazione Italia Field Kvadrat, Elmo Neocoast, Steelcut Trio 3 Kvadrat.														

## Frame Base



## Shell



# Cila

Design by Lievore Altherr, 2018

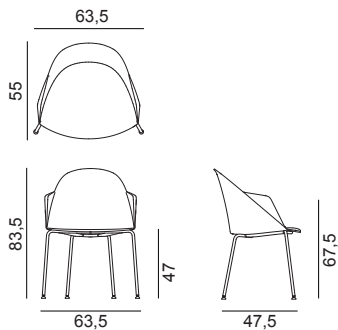

Armchair with four-leg base made of chromed or powdercoated steel. Shell fully upholstered in fabric, leather, coated fabric, or customer's material. Optional glides with felt for wooden floors are available upon request.

SEK ART. 2222	A	B COM	C COL	D	E	F	G	H	I	J	K	L	M	ES
CHROMED / POWDERCOATED	5703	6120	6537	6954	7371	7788	8205	8622	9039	9456	9873	10290	10707	12205
<b>SHIPMENT DETAILS</b>		<b>TECHNICAL SPECIFICATIONS</b>				<b>RESISTANCE TEST</b>								
<b>Art.2222</b> 1 pz = 2  - kg 13,13/ m³ 0,398 4 pz = 2  - kg 39,06/ m³ 0,564		<b>Art.2222</b> COL requirement m² 3.3 H 140 cm. COM Meterage m 1.47 *Classe 1, 2, 1IM: fire retardant version available with surcharge and eventual minimum batch				<ul style="list-style-type: none"> <li>TUV GS (EN16139)</li> </ul>								
<b>FIRE RETARDANT TEST</b>														
Classe 1IM Omologazione Italia Field Kvadrat. * FIRE RETARDANT VERSION WITH SURCHARGE * Classe 1IM Omologazione Italia Steelcut Trio 3 Kvadrat.														

## Frame Base



# Cila

Design by Lievore Altherr, 2017

Chair with timber oak four-leg base (natural oak, bleached oak, wengé). Polypropylene shell available in five colours. Optional glides with felt for wooden floors are available upon request.

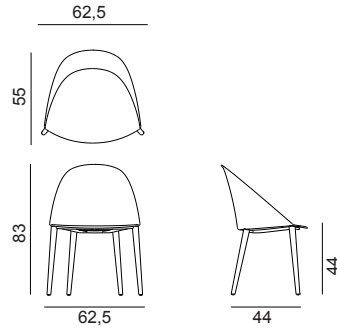

<b>SEK ART. 2204</b>	PC	
WOOD LEGS	3750	
<b>SHIPMENT DETAILS</b>	<b>TECHNICAL SPECIFICATIONS</b>	<b>RESISTANCE TEST</b>
<b>Art.2204</b> 1 pz = 2  - kg 10,43/ m³ 0,357 4 pz = 2  - kg 29,77/ m³ 0,422	<b>Art.2204</b> *Classe 1, 2, 11M: fire retardant version available with surcharge and eventual minimum batch	<ul style="list-style-type: none"> <li>• EN 1728:2012 - EN 16139:2013 6.15</li> <li>• EN 1728:2012 - EN 16139:2013 6.17</li> <li>• EN 1728:2012 - EN 16139:2013 6.24</li> <li>• EN 1728:2012 - EN 16139:2013 6.4</li> <li>• TUV GS (EN16139)</li> <li>• EN 1728:2012 - EN 16139:2013 6.16</li> <li>• EN 1728:2012 - EN 16139:2013 6.18</li> <li>• EN 1728:2012 - EN 16139:2013 6.25</li> <li>• EN 1728:2012 - EN 16139:2013 6.5</li> <li>• EN 1728:2012 - EN 16139:2013 6. 6</li> </ul>
<b>FIRE RETARDANT TEST</b>		
• FIRE RETARDANT VERSION WITH SURCHARGE * Classe 2 Omologazione Italia Polipropilene.		

## Frame Base

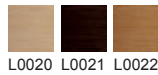

L0020 L0021 L0022



## Shell



PC00001 PC00002 PC00003 PC00004 PC00005



# Cila

Design by Lievore Altherr, 2017

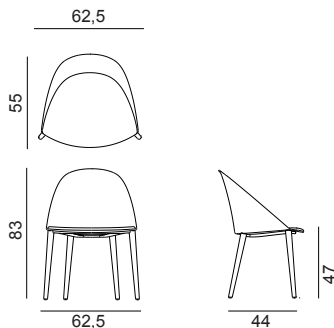

Chair with timber oak four-leg base (natural oak, bleached oak, wengé). Polypropylene shell available in five colours, with seat cushion in leather, coated fabric, fabric or customer's own material. Optional glides with felt for wooden floors are available upon request.

SEK ART. 2205	A	B COM	C COL	D	E	F	G	H	I	J	K	L	M	ES
WOOD LEGS	4739	4834	4929	5024	5119	5214	5309	5404	5499	5594	5689	5784	5879	6310
<b>SHIPMENT DETAILS</b>	<b>TECHNICAL SPECIFICATIONS</b>				<b>RESISTANCE TEST</b>									
<b>Art.2205</b> 1 pz = 2  - kg 12,61/ m³ 0,397 4 pz = 2  - kg 34,61/ m³ 0,497	<b>Art.2205</b> COL requirement m² 0.756 H 140 cm. COM Meterage m 0.41				<ul style="list-style-type: none"> <li>TUV GS (EN16139)</li> </ul>									
<b>FIRE RETARDANT TEST</b>														
Classe 1IM Omologazione Italia Field Kvadrat. Elmo Neocoast. Remix 3 Kvadrat. Steelcut 2 Kvadrat. Steelcut Trio 3 Kvadrat. Coated fabric Valencia Spradling.														

## Frame Base



L0020 L0021 L0022



## Shell



PC00001 PC00002 PC00003 PC00004 PC00005



# Cila

Design by Lievore Altherr, 2017

Chair with timber oak four-leg base (natural oak, bleached oak, wengé). Shell fully upholstered in leather, coated fabric, fabric or customer's own material. Optional glides with felt for wooden floors are available upon request.

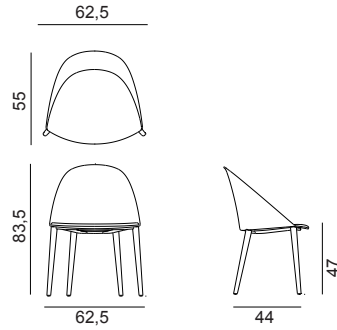

SEK ART. 2207	A	B COM	C COL	D	E	F	G	H	I	J	K	L	M	ES
WOOD LEGS	6751	7061	7371	7681	7991	8301	8611	8921	9231	9541	9851	10161	10471	11918

SHIPMENT DETAILS	TECHNICAL SPECIFICATIONS	RESISTANCE TEST
<b>Art.2207</b> 1 pz = 2  - kg 13,11/ m³ 0,397 4 pz = 2  - kg 36,61/ m³ 0,497	<b>Art.2207</b> COL requirement m² 3 H 140 cm. COM Meterage m 1.31 *Classe 1, 2, 1IM: fire retardant version available with surcharge and eventual minimum batch	• TUV GS (EN16139)
<b>FIRE RETARDANT TEST</b> Classe 1IM Omologazione Italia Field Kvadrat. Remix 3 Kvadrat. Steelcut 2 Kvadrat. • FIRE RETARDANT VERSION WITH SURCHARGE * Classe 1IM Omologazione Italia Steelcut Trio 3 Kvadrat. Coated fabric Valencia Spradling.		

Frame Base

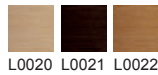

# Cila

Design by Lievore Altherr, 2018

Armchair with timber oak four-leg base (natural oak, bleached oak, wengé). Polypropylene shell available in five colours. Optional glides with felt for wooden floors are available upon request.

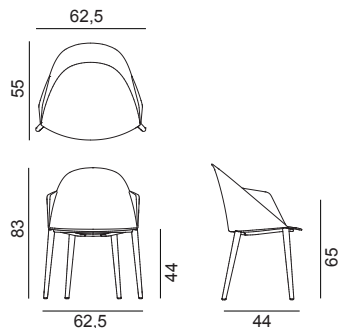

<b>SEK ART. 2223</b>	PC	
WOOD LEGS	4108	
<b>SHIPMENT DETAILS</b>	<b>TECHNICAL SPECIFICATIONS</b>	<b>RESISTANCE TEST</b>
<b>Art.2223</b> 1 pz = 2  - kg 10,87/ m³ 0,38 4 pz = 2  - kg 30,83/ m³ 0,447	<b>Art.2223</b> *Classe 1, 2, 11M: fire retardant version available with surcharge and eventual minimum batch	<ul style="list-style-type: none"> <li>TUV GS (EN16139)</li> </ul>
<b>FIRE RETARDANT TEST</b>		
* FIRE RETARDANT VERSION WITH SURCHARGE * Classe 2 Omologazione Italia Polipropilene.		

## Frame Base



L0020 L0021 L0022



## Shell



PC00001 PC00002 PC00003 PC00004 PC00005



# Cila

Design by Lievore Altherr, 2018

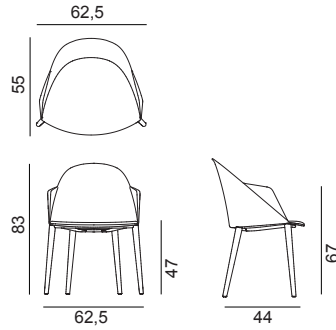

Armchair with timber oak four-leg base (natural oak, bleached oak, wengé). Polypropylene shell available in five colours, with seat cushion in leather, coated fabric, fabric or customer's own material. Optional glides with felt for wooden floors are available upon request.

SEK ART. 2224	A	B COM	C COL	D	E	F	G	H	I	J	K	L	M	ES
WOOD LEGS	5084	5179	5274	5369	5464	5559	5654	5749	5844	5939	6034	6129	6224	6668
<b>SHIPMENT DETAILS</b>		<b>TECHNICAL SPECIFICATIONS</b>				<b>RESISTANCE TEST</b>								
<b>Art.2224</b> 1 pz = 2  - kg 12,78/ m³ 0,457 4 pz = 2  - kg 36,11/ m³ 0,56		<b>Art.2224</b> COL requirement m² 0.756 H 140 cm. COM Meterage m 0.41				<ul style="list-style-type: none"> <li>TUV GS (EN16139)</li> </ul>								
<b>FIRE RETARDANT TEST</b>														
Classe 1IM Omologazione Italia Field Kvadrat, Elmo Neocoast, Steelcut Trio 3 Kvadrat.														

## Frame Base

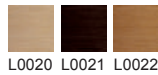

L0020 L0021 L0022



## Shell



PC00001 PC00002 PC00003 PC00004 PC00005





# Cila

Design by Lievore Altherr, 2018

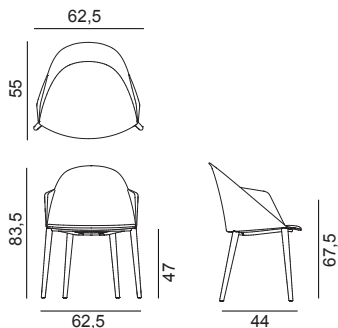

Armchair with timber oak four-leg base (natural oak, bleached oak, wengé). Shell fully upholstered in leather, coated fabric, fabric or customer's own material. Optional glides with felt for wooden floors are available upon request.

SEK ART. 2225	A	B COM	C COL	D	E	F	G	H	I	J	K	L	M	ES
WOOD LEGS	7108	7525	7942	8359	8776	9193	9610	10027	10444	10861	11278	11695	12112	13610
<b>SHIPMENT DETAILS</b>	<b>TECHNICAL SPECIFICATIONS</b>				<b>RESISTANCE TEST</b>									
<b>Art.2225</b> 1 pz = 2  - kg 13,75/ m³ 0,457 4 pz = 2  - kg 40/ m³ 0,56	<b>Art.2225</b> COL requirement m² 3.3 H 140 cm. COM Meterage m 1.47 *Classe 1, 2, 1IM: fire retardant version available with surcharge and eventual minimum batch				• TUV GS (EN16139)									
<b>FIRE RETARDANT TEST</b> Classe 1IM Omologazione Italia Field Kvadrat. • FIRE RETARDANT VERSION WITH SURCHARGE * Classe 1IM Omologazione Italia Steelcut Trio 3 Kvadrat.														

Frame Base

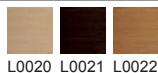

# Cila

Design by Lievore Altherr, 2017

Chair with chromed or powder-coated steel sled base and polypropylene shell available in five colours. Optional glides with felt for wooden floors are available upon request.

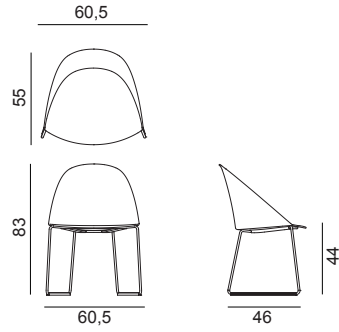

<b>SEK ART. 2208</b>	PC	
CHROMED / POWDERCOATED	2571	
<b>SHIPMENT DETAILS</b>	<b>TECHNICAL SPECIFICATIONS</b>	<b>RESISTANCE TEST</b>
<b>Art.2208</b> 1 pz = 2  - kg 10,88/ m² 0,298 4 pz = 2  - kg 33,11/ m² 0,426	<b>Art.2208</b> *Classe 1, 2, 11M: fire retardant version available with surcharge and eventual minimum batch	<ul style="list-style-type: none"> <li>• EN 1728:2012 - EN 16139:2013 6.15</li> <li>• EN 1728:2012 - EN 16139:2013 6.17</li> <li>• EN 1728:2012 - EN 16139:2013 6.24</li> <li>• EN 1728:2012 - EN 16139:2013 6.4</li> <li>• TUV GS (EN16139)</li> <li>• EN 1728:2012 - EN 16139:2013 6.16</li> <li>• EN 1728:2012 - EN 16139:2013 6.18</li> <li>• EN 1728:2012 - EN 16139:2013 6.25</li> <li>• EN 1728:2012 - EN 16139:2013 6.5</li> <li>• EN 1728:2012 - EN 16139:2013 6. 6</li> </ul>
<b>FIRE RETARDANT TEST</b>		
• FIRE RETARDANT VERSION WITH SURCHARGE * Classe 2 Omologazione Italia Polipropilene.		

## Frame Base



## Shell



# Cila

Design by Lievore Altherr, 2017

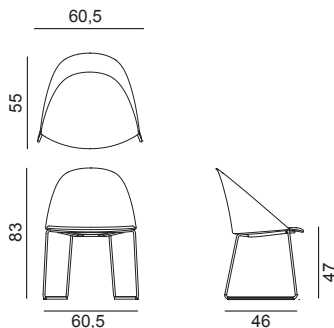

Chair with chromed or powder-coated steel sled base and polypropylene shell available in five colors, with seat cushion in leather, coated fabric, fabric or customer's own material. Optional glides with felt for wooden floors are available upon request.

SEK ART. 2209	A	B COM	C COL	D	E	F	G	H	I	J	K	L	M	ES
CHROMED / POWDERCOATED	3560	3655	3750	3845	3940	4035	4130	4225	4320	4415	4510	4605	4700	5131
<b>SHIPMENT DETAILS</b>		<b>TECHNICAL SPECIFICATIONS</b>				<b>RESISTANCE TEST</b>								
<b>Art.2209</b> 1 pz = 2  - kg 13,06/ m³ 0,337 4 pz = 2  - kg 37,95/ m³ 0,501		<b>Art.2209</b> COL requirement m² 0.756 H 140 cm. COM Meterage m 0.41				<ul style="list-style-type: none"> <li>TUV GS (EN16139)</li> </ul>								
<b>FIRE RETARDANT TEST</b>														
Classe 1IM Omologazione Italia Field Kvadrat. Elmo Neocoast. Remix 3 Kvadrat. Steelcut 2 Kvadrat. Steelcut Trio 3 Kvadrat. Coated fabric Valencia Spradling.														

## Frame Base



## Shell



# Cila

Design by Lievore Altherr, 2017

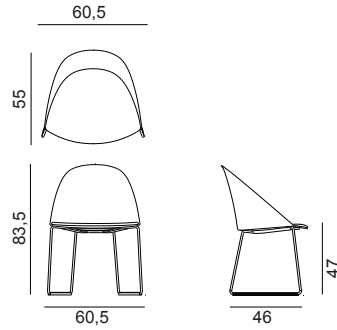

Chair with chromed or powder-coated steel sled base and shell fully upholstered in leather, coated fabric, fabric or customer's own material. Glides for wooden floors available upon request without surcharge.

SEK ART. 2211	A	B COM	C COL	D	E	F	G	H	I	J	K	L	M	ES
CHROMED / POWDERCOATED	5572	5882	6192	6502	6812	7122	7432	7742	8052	8362	8672	8982	9292	10739
<b>SHIPMENT DETAILS</b>	<b>TECHNICAL SPECIFICATIONS</b>				<b>RESISTANCE TEST</b>									
<b>Art.2211</b> 1 pz = 2  - kg 13,56/ m² 0,337 4 pz = 2  - kg 39,95/ m² 0,501	<b>Art.2211</b> COL requirement m² 3 H 140 cm. COM Meterage m 1.31 *Classe 1, 2, 1IM: fire retardant version available with surcharge and eventual minimum batch				• TUV GS (EN16139)									
<b>FIRE RETARDANT TEST</b> Classe 1IM Omologazione Italia Field Kvadrat. Remix 3 Kvadrat. Steelcut 2 Kvadrat. • FIRE RETARDANT VERSION WITH SURCHARGE * Classe 1IM Omologazione Italia Steelcut Trio 3 Kvadrat. Coated fabric Valencia Spradling.														

## Frame Base



# Cila

Design by Lievore Altherr, 2018

Armchair on sled base in chromed or powder-coated steel. Polypropylene shell available in 5 colours. Optional glides with felt for wooden floors are available upon request.

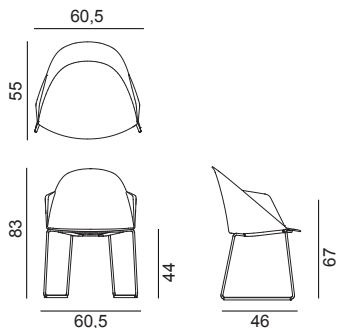

<b>SEK ART. 2226</b>	PC	
CHROMED / POWDERCOATED	2929	
<b>SHIPMENT DETAILS</b>	<b>TECHNICAL SPECIFICATIONS</b>	<b>RESISTANCE TEST</b>
<b>Art.2226</b> 1 pz = 2  - kg 11,32/ m³ 0,32 4 pz = 2  - kg 34,17/ m³ 0,451	<b>Art.2226</b> *Classe 1, 2, 1IM: fire retardant version available with surcharge and eventual minimum batch	<ul style="list-style-type: none"> <li>TUV GS (EN16139)</li> </ul>
<b>FIRE RETARDANT TEST</b>		
* FIRE RETARDANT VERSION WITH SURCHARGE * Classe 2 Omologazione Italia Polipropilene.		

## Frame Base



## Shell



# Cila

Design by Lievore Altherr, 2018

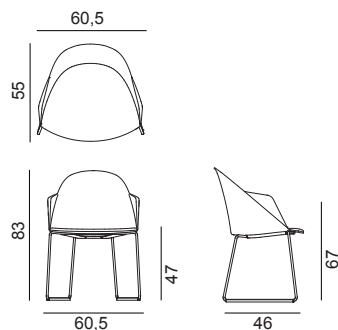

Armchair on sled base in chromed or powder-coated steel. Polypropylene shell available in 5 colours, with seat cushion in fabric, leather, coated fabric, or customer's material. Optional glides with felt for wooden floors are available upon request.

SEK ART. 2227	A	B COM	C COL	D	E	F	G	H	I	J	K	L	M	ES
CHROMED / POWDERCOATED	3905	4000	4095	4190	4285	4380	4475	4570	4665	4760	4855	4950	5045	5489
<b>SHIPMENT DETAILS</b>		<b>TECHNICAL SPECIFICATIONS</b>				<b>RESISTANCE TEST</b>								
<b>Art.2227</b> 1 pz = 2  - kg 13,23/ m² 0,398 4 pz = 2  - kg 39,45/ m² 0,564		<b>Art.2227</b> COL requirement m² 0.756 H 140 cm. COM Meterage m 0.41				• TUV GS (EN16139)								
<b>FIRE RETARDANT TEST</b>														
Classe 11M Omologazione Italia Field Kvadrat, Elmo Neocoast, Steelcut Trio 3 Kvadrat.														

## Frame Base



## Shell



# Cila

Design by Lievore Altherr, 2018

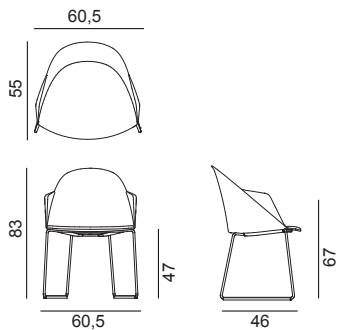

Armchair on sled base in chromed or powder-coated steel. Shell fully upholstered in fabric, leather, coated fabric, or customer's material. Optional glides with felt for wooden floors are available upon request.

SEK ART. 2228	A	B COM	C COL	D	E	F	G	H	I	J	K	L	M	ES
CHROMED / POWDERCOATED	5929	6346	6763	7180	7597	8014	8431	8848	9265	9682	10099	10516	10933	12431
<b>SHIPMENT DETAILS</b>		<b>TECHNICAL SPECIFICATIONS</b>				<b>RESISTANCE TEST</b>								
<b>Art.2228</b> 1 pz = 2  - kg 14,2/ m³ 0,398 4 pz = 2  - kg 43,34/ m³ 0,564		<b>Art.2228</b> COL requirement m² 3.3 H 140 cm. COM Meterage m 1.47 *Classe 1, 2, 1IM: fire retardant version available with surcharge and eventual minimum batch				• TUV GS (EN16139)								
<b>FIRE RETARDANT TEST</b>														
Classe 1IM Omologazione Italia Field Kvadrat. • FIRE RETARDANT VERSION WITH SURCHARGE * Classe 1IM Omologazione Italia Steelcut Trio 3 Kvadrat.														

## Frame Base



# Cila

Design by Lievore Altherr, 2017

Chair with polished or powder-coated aluminium swivel trestle base. Polypropylene shell available in five colors. Optional glides with felt for wooden floors are available upon request.

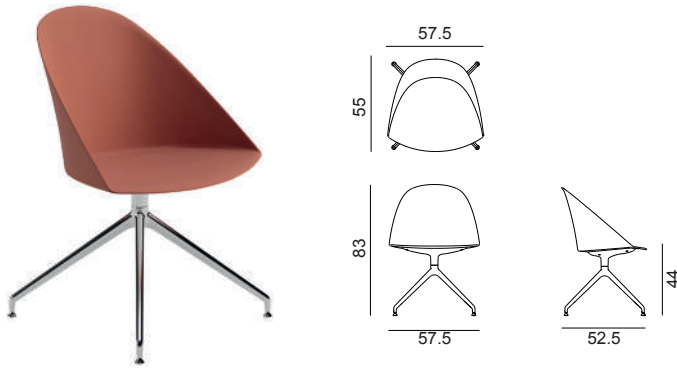

<b>SEK ART. 2212</b>	PC	
POLISHED / POWDERCOATED	4262	
<b>SHIPMENT DETAILS</b>	<b>TECHNICAL SPECIFICATIONS</b>	<b>RESISTANCE TEST</b>
<b>Art.2212</b> 1 pz = 2  - kg 12,12/ m³ 0,294 4 pz = 2  - kg 38,39/ m³ 0,426	<b>Art.2212</b> *Classe 1, 2, 11M: fire retardant version available with surcharge and eventual minimum batch	<ul style="list-style-type: none"> <li>• EN 1728:2012 - EN 16139:2013 6.15</li> <li>• EN 1728:2012 - EN 16139:2013 6.17</li> <li>• EN 1728:2012 - EN 16139:2013 6.24</li> <li>• EN 1728:2012 - EN 16139:2013 6.4</li> <li>• TUV GS (EN16139)</li> </ul> <ul style="list-style-type: none"> <li>• EN 1728:2012 - EN 16139:2013 6.16</li> <li>• EN 1728:2012 - EN 16139:2013 6.18</li> <li>• EN 1728:2012 - EN 16139:2013 6.25</li> <li>• EN 1728:2012 - EN 16139:2013 6.5</li> <li>• EN 1728:2012 - EN 16139:2013 6. 6</li> </ul>
<b>FIRE RETARDANT TEST</b>		
• FIRE RETARDANT VERSION WITH SURCHARGE * Classe 2 Omologazione Italia Polipropilene.		

## Frame Base



## Shell





# Cila

Design by Lievore Altherr, 2017

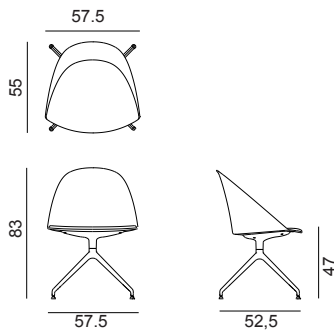

Chair with polished or powder-coated aluminium swivel trestle base. Polypropylene shell available in five colors, with seat cushion in leather, coated fabric, fabric or customer's own material. Optional glides with felt for wooden floors are available upon request.

SEK ART. 2213	A	B COM	C COL	D	E	F	G	H	I	J	K	L	M	ES
POLISHED / POWDERCOATED	5251	5346	5441	5536	5631	5726	5821	5916	6011	6106	6201	6296	6391	6822
<b>SHIPMENT DETAILS</b>	<b>TECHNICAL SPECIFICATIONS</b>				<b>RESISTANCE TEST</b>									
<b>Art.2213</b> 1 pz = 2  - kg 14,3/ m³ 0,333 4 pz = 2  - kg 43,23/ m³ 0,501	<b>Art.2213</b> COL requirement m² 0.756 H 140 cm. COM Meterage m 0.41				<ul style="list-style-type: none"> <li>TUV GS (EN16139)</li> </ul>									
<b>FIRE RETARDANT TEST</b>														
Classe 1IM Omologazione Italia Field Kvadrat. Elmo Neocoast. Remix 3 Kvadrat. Steelcut 2 Kvadrat. Steelcut Trio 3 Kvadrat. Coated fabric Valencia Spradling.														

## Frame Base



## Shell



# Cila

Design by Lievore Altherr, 2017

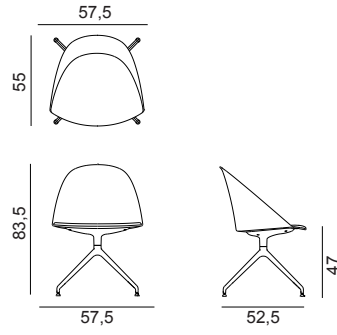

Chair with polished or powder-coated aluminium swivel trestle base. Shell fully upholstered in leather, coated fabric, fabric or customer's own material. Optional glides with felt for wooden floors are available upon request.

SEK ART. 2215	A	B COM	C COL	D	E	F	G	H	I	J	K	L	M	ES
POLISHED / POWDERCOATED	7263	7573	7883	8193	8503	8813	9123	9433	9743	10053	10363	10673	10983	12430
<b>SHIPMENT DETAILS</b>		<b>TECHNICAL SPECIFICATIONS</b>				<b>RESISTANCE TEST</b>								
<b>Art.2215</b> 1 pz = 2  - kg 14,8/ m³ 0,333 4 pz = 2  - kg 45,23/ m³ 0,501		<b>Art.2215</b> COL requirement m² 3 H 140 cm. COM Meterage m 1.31 *Classe 1, 2, 1IM: fire retardant version available with surcharge and eventual minimum batch				• TUV GS (EN16139)								
<b>FIRE RETARDANT TEST</b>														
Classe 1IM Omologazione Italia Field Kvadrat. Remix 3 Kvadrat. Steelcut 2 Kvadrat. • FIRE RETARDANT VERSION WITH SURCHARGE * Classe 1IM Omologazione Italia Steelcut Trio 3 Kvadrat. Coated fabric Valencia Spradling.														

## Frame Base



# Cila

Design by Lievore Altherr, 2018

Armchair with polished or powder-coated aluminium swivel trestle base. Polypropylene shell available in 5 colours. Optional glides with felt for wooden floors are available upon request.

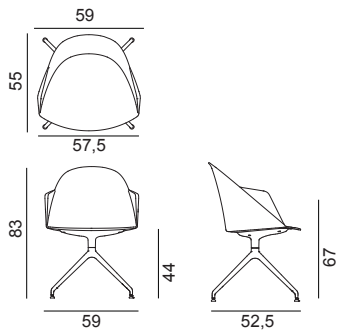

<b>SEK ART. 2229</b>	PC	
POLISHED / POWDERCOATED	4620	
<b>SHIPMENT DETAILS</b>	<b>TECHNICAL SPECIFICATIONS</b>	<b>RESISTANCE TEST</b>
<b>Art.2229</b> 1 pz = 2  - kg 12,56/ m³ 0,316 4 pz = 2  - kg 39,45/ m³ 0,451	<b>Art.2229</b> *Classe 1, 2, 11M: fire retardant version available with surcharge and eventual minimum batch	<ul style="list-style-type: none"> <li>TUV GS (EN16139)</li> </ul>
<b>FIRE RETARDANT TEST</b>		
* FIRE RETARDANT VERSION WITH SURCHARGE * Classe 2 Omologazione Italia Polipropilene.		

## Frame Base



## Shell



# Cila

Design by Lievore Altherr, 2018

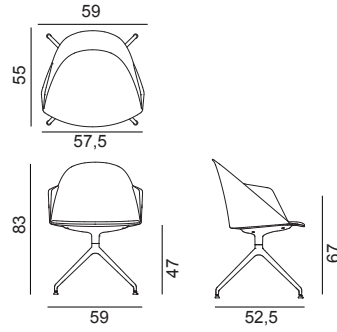

Armchair with polished or powder-coated aluminium swivel trestle base. Polypropylene shell available in 5 colours, with seat cushion in fabric, leather, coated fabric, or customer's material. Optional glides with felt for wooden floors are available upon request.

SEK ART. 2230	A	B COM	C COL	D	E	F	G	H	I	J	K	L	M	ES
POLISHED / POWDERCOATED	5596	5691	5786	5881	5976	6071	6166	6261	6356	6451	6546	6641	6736	7180
<b>SHIPMENT DETAILS</b>		<b>TECHNICAL SPECIFICATIONS</b>				<b>RESISTANCE TEST</b>								
<b>Art.2230</b> 1 pz = 2  - kg 14,47/ m³ 0,394 4 pz = 2  - kg 44,73/ m³ 0,564		<b>Art.2230</b> COL requirement m² 0.756 H 140 cm. COM Meterage m 0.41				• TUV GS (EN16139)								
<b>FIRE RETARDANT TEST</b>														
Classe 11M Omologazione Italia Field Kvadrat. Elmo Neocoast. Steelcut Trio 3 Kvadrat.														

## Frame Base



## Shell



# Cila

Design by Lievore Altherr, 2018

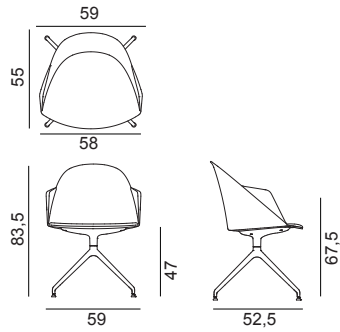

Armchair with polished or powder-coated aluminium swivel trestle base. Shell fully upholstered in fabric, leather, coated fabric, or customer's material. Optional glides with felt for wooden floors are available upon request.

SEK ART. 2231	A	B COM	C COL	D	E	F	G	H	I	J	K	L	M	ES
POLISHED / POWDERCOATED	7620	8037	8454	8871	9288	9705	10122	10539	10956	11373	11790	12207	12624	14122
<b>SHIPMENT DETAILS</b>		<b>TECHNICAL SPECIFICATIONS</b>				<b>RESISTANCE TEST</b>								
<b>Art.2231</b> 1 pz = 2  - kg 15,44/ m³ 0,394 4 pz = 2  - kg 48,62/ m³ 0,564		<b>Art.2231</b> COL requirement m² 3.3 H 140 cm. COM Meterage m 1.47 *Classe 1, 2, 1IM: fire retardant version available with surcharge and eventual minimum batch				<ul style="list-style-type: none"> <li>TUV GS (EN16139)</li> </ul>								
<b>FIRE RETARDANT TEST</b>														
Classe 1IM Omologazione Italia Field Kvadrat. * FIRE RETARDANT VERSION WITH SURCHARGE * Classe 1IM Omologazione Italia Steelcut Trio 3 Kvadrat.														

## Frame Base



# Cila

Design by Lievore Altherr, 2017

Chair with polished or powder-coated aluminium fixed trestle base, mounted on selfbraking castors. Polypropylene shell available in five colors.

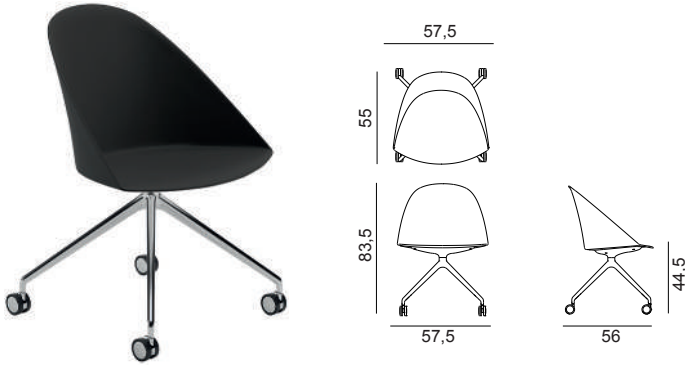

<b>SEK ART. 2216</b>	PC	
POLISHED / POWDERCOATED	4679	
<b>SHIPMENT DETAILS</b>	<b>TECHNICAL SPECIFICATIONS</b>	<b>RESISTANCE TEST</b>
<b>Art.2216</b> 1 pz = 2  - kg 12,22/ m³ 0,294 4 pz = 2  - kg 38,79/ m³ 0,426	<b>Art.2216</b> *Classe 1, 2, 11M: fire retardant version available with surcharge and eventual minimum batch	<ul style="list-style-type: none"> <li>• EN 1728:2012 - EN 16139:2013 6.15</li> <li>• EN 1728:2012 - EN 16139:2013 6.17</li> <li>• EN 1728:2012 - EN 16139:2013 6.24</li> <li>• EN 1728:2012 - EN 16139:2013 6.4</li> <li>• TUV GS (EN16139)</li> </ul> <ul style="list-style-type: none"> <li>• EN 1728:2012 - EN 16139:2013 6.16</li> <li>• EN 1728:2012 - EN 16139:2013 6.18</li> <li>• EN 1728:2012 - EN 16139:2013 6.25</li> <li>• EN 1728:2012 - EN 16139:2013 6.5</li> <li>• EN 1728:2012 - EN 16139:2013 6.6</li> </ul>
<b>FIRE RETARDANT TEST</b>		
• FIRE RETARDANT VERSION WITH SURCHARGE * Classe 2 Omologazione Italia Polipropilene.		

## Frame Base



## Shell



# Cila

Design by Lievore Altherr, 2017

Chair with polished or powder-coated aluminium fixed trestle base, mounted on selfbraking castors. Polypropylene shell available in five colors, with seat cushion in leather, coated fabric, fabric or customer's own material.

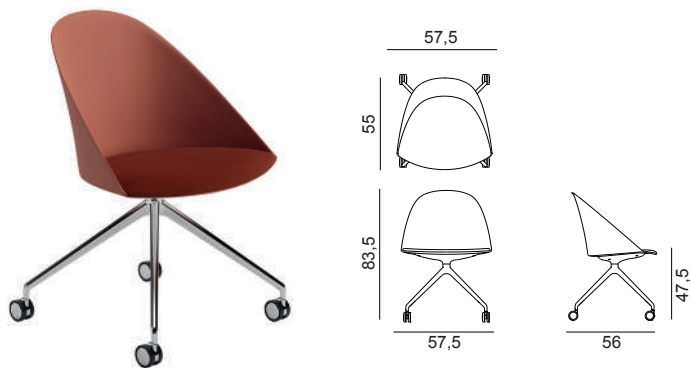

SEK ART. 2217	A	B COM	C COL	D	E	F	G	H	I	J	K	L	M	ES
POLISHED / POWDERCOATED	5668	5763	5858	5953	6048	6143	6238	6333	6428	6523	6618	6713	6808	7239
<b>SHIPMENT DETAILS</b>		<b>TECHNICAL SPECIFICATIONS</b>				<b>RESISTANCE TEST</b>								
<b>Art.2217</b> 1 pz = 2  - kg 14,4/ m³ 0,333 4 pz = 2  - kg 43,63/ m³ 0,501		<b>Art.2217</b> COL requirement m² 0.756 H 140 cm. COM Meterage m 0.41				<ul style="list-style-type: none"> <li>TUV GS (EN16139)</li> </ul>								
<b>FIRE RETARDANT TEST</b>														
Classe 1IM Omologazione Italia Field Kvadrat. Elmo Neocoast. Remix 3 Kvadrat. Steelcut 2 Kvadrat. Steelcut Trio 3 Kvadrat. Coated fabric Valencia Spradling.														

## Frame Base



## Shell



# Cila

Design by Lievore Altherr, 2017

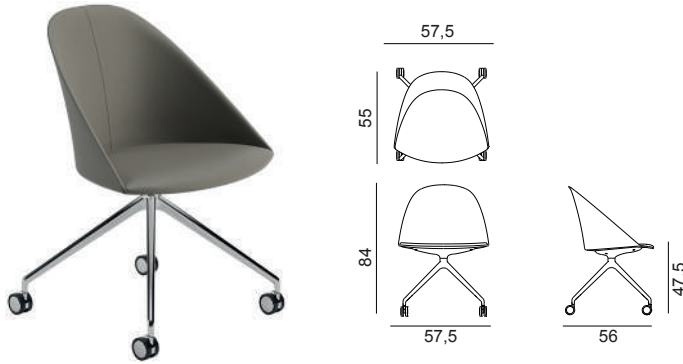

Chair with polished or powder-coated aluminium fixed trestle base, mounted on selfbraking castors. Shell fully upholstered in leather, coated fabric, fabric or customer's own material.

SEK ART. 2219	A	B COM	C COL	D	E	F	G	H	I	J	K	L	M	ES
POLISHED / POWDERCOATED	7680	7990	8300	8610	8920	9230	9540	9850	10160	10470	10780	11090	11400	12847
<b>SHIPMENT DETAILS</b>	<b>TECHNICAL SPECIFICATIONS</b>				<b>RESISTANCE TEST</b>									
<b>Art.2219</b> 1 pz = 2  - kg 14,9/ m³ 0,333 4 pz = 2  - kg 45,63/ m³ 0,501	<b>Art.2219</b> COL requirement m² 3 H 140 cm. COM Meterage m 1.31 *Classe 1, 2, 1IM: fire retardant version available with surcharge and eventual minimum batch				• TUV GS (EN16139)									
<b>FIRE RETARDANT TEST</b> Classe 1IM Omologazione Italia Field Kvadrat. Remix 3 Kvadrat. Steelcut 2 Kvadrat. • FIRE RETARDANT VERSION WITH SURCHARGE * Classe 1IM Omologazione Italia Steelcut Trio 3 Kvadrat. Coated fabric Valencia Spradling.														

## Frame Base





# Cila

Design by Lievore Altherr, 2018

Armchair with polished or powder-coated aluminium fixed trestle base mounted on self-braking castors. Polypropylene shell available in 5 colours.

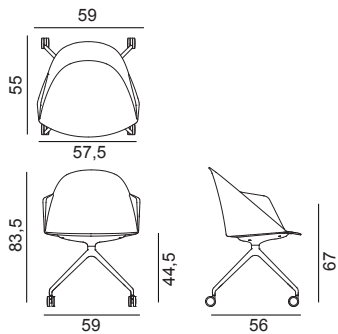

<b>SEK ART. 2232</b>	PC	
POLISHED / POWDERCOATED	5037	
<b>SHIPMENT DETAILS</b>	<b>TECHNICAL SPECIFICATIONS</b>	<b>RESISTANCE TEST</b>
<b>Art.2232</b> 1 pz = 2  - kg 12,66/ m³ 0,316 4 pz = 2  - kg 39,85/ m³ 0,451	<b>Art.2232</b> *Classe 1, 2, 11M: fire retardant version available with surcharge and eventual minimum batch	<ul style="list-style-type: none"> <li>TUV GS (EN16139)</li> </ul>
<b>FIRE RETARDANT TEST</b>		
* FIRE RETARDANT VERSION WITH SURCHARGE * Classe 2 Omologazione Italia Polipropilene.		

## Frame Base



## Shell



# Cila

Design by Lievore Altherr, 2018

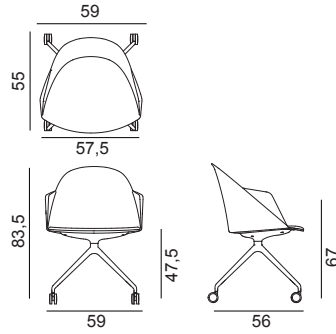

Armchair with polished or powder-coated aluminium fixed trestle base mounted on self-braking castors. Polypropylene shell available in 5 colours, with seat cushion in fabric, leather, coated fabric, or customer's material.

SEK ART. 2233	A	B COM	C COL	D	E	F	G	H	I	J	K	L	M	ES
POLISHED / POWDERCOATED	6013	6108	6203	6298	6393	6488	6583	6678	6773	6868	6963	7058	7153	7597
<b>SHIPMENT DETAILS</b>		<b>TECHNICAL SPECIFICATIONS</b>				<b>RESISTANCE TEST</b>								
<b>Art.2233</b> 1 pz = 2  - kg 14,57/ m³ 0,394 4 pz = 2  - kg 45,13/ m³ 0,564		<b>Art.2233</b> COL requirement m² 0.756 H 140 cm. COM Meterage m 0.41				<ul style="list-style-type: none"> <li>TUV GS (EN16139)</li> </ul>								
<b>FIRE RETARDANT TEST</b>														
Classe 11M Omologazione Italia Field Kvadrat. Elmo Neocoast. Steelcut Trio 3 Kvadrat.														

## Frame Base



## Shell



# Cila

Design by Lievore Altherr, 2018

Armchair with polished or powder-coated aluminium fixed trestle base mounted on self-braking castors. Shell fully upholstered in fabric, leather, coated fabric, or customer's material.

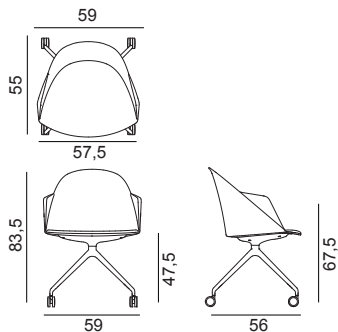

SEK ART. 2234	A	B COM	C COL	D	E	F	G	H	I	J	K	L	M	ES
POLISHED / POWDERCOATED	8037	8454	8871	9288	9705	10122	10539	10956	11373	11790	12207	12624	13041	14539

SHIPMENT DETAILS	TECHNICAL SPECIFICATIONS	RESISTANCE TEST
<b>Art.2234</b> 1 pz = 2  - kg 15,54/ m³ 0,394 4 pz = 2  - kg 49,02/ m³ 0,564	<b>Art.2234</b> COL requirement m² 3.3 H 140 cm. COM Meterage m 1.47 *Classe 1, 2, 1IM: fire retardant version available with surcharge and eventual minimum batch	• TUV GS (EN16139)

**FIRE RETARDANT TEST**  
 Classe 1IM Omologazione Italia Field Kvadrat.  
 • FIRE RETARDANT VERSION WITH SURCHARGE \* Classe 1IM Omologazione Italia Steelcut Trio 3 Kvadrat.

**Frame Base**



# CILA GO

---

Design by  
Lievore Altherr  
2018



# Cila Go

## Collection overview

### Type



Polypropylene chair mounted on castors



Polypropylene chair mounted on castors, with seat cushion



Polypropylene armchair mounted on castors



Polypropylene armchair mounted on castors, with seat cushion



Stool with castors

### Shell

#### Chair version



Polypropylene

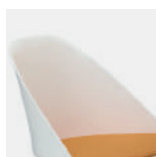

Polypropylene with seat cushion

#### Armchair version



Polypropylene



Polypropylene with seat cushion

### Accessories



Writing tablet 50x33,5 cm



### Movement on castors



All versions of Cila Go (chair, armchair, and stool) are mounted on castors to ease movement.

# Cila Go

## Collection overview

### Type



Chair on a 5 way reinforced nylon fibre swivel base



Chair on a 5 way reinforced nylon fibre swivel base + writing tablet



Armchair on a 5 way reinforced nylon fibre swivel base



Armchair on a 5 way reinforced nylon fibre swivel base + writing tablet

### Shell

#### Chair version



Polypropylene



Polypropylene with seat cushion



Upholstered with non-removable cover

#### Armchair version



Polypropylene



Polypropylene with seat cushion



Upholstered with non-removable cover

# Cila Go

Design by Lievore Altherr, 2018

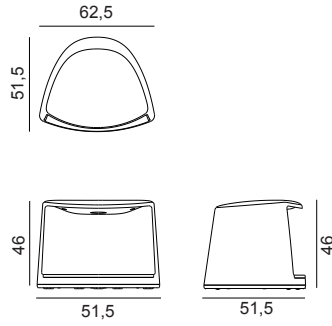

Stool on polypropylene storage base, available in 4 colours, with castors and fitted with cushion applied to the seat in fabric, leather, coated fabric, or customer's material.

Accessories:  
Writing tablet 50x33,5 cm Art. 2307

SEK ART. 2300	A	B COM	C COL	D	E	F	G	H	I	J	K	L	M	ES
	4073	4168	4263	4358	4453	4548	4643	4738	4833	4928	5023	5118	5213	5621
<b>SHIPMENT DETAILS</b>	<b>TECHNICAL SPECIFICATIONS</b>				<b>RESISTANCE TEST</b>									
<b>Art.2300</b> 1 pz = 2  - kg 14,36/ m³ 0,185 4 pz = 5  - kg 56,2/ m³ 0,743 KD	<b>Art.2300</b> COL requirement m² 0.756 H 140 cm. COM Meterage m 0.41				• TUV GS (EN16139)									
<b>FIRE RETARDANT TEST</b>														
Classe 1IM Omologazione Italia Field Kvadrat. Remix 3 Kvadrat. Steelcut 2 Kvadrat. Steelcut Trio 3 Kvadrat. Coated fabric Valencia Spradling.														

Frame Base



PC00001PC00002PC00003PC00004



# Cila Go

Design by Lievore Altherr, 2018

Chair on polypropylene storage base, available in 4 colours, with castors. Polypropylene shell available in 5 colours.

Accessories:  
Writing tablet 50x33,5 cm Art. 2307

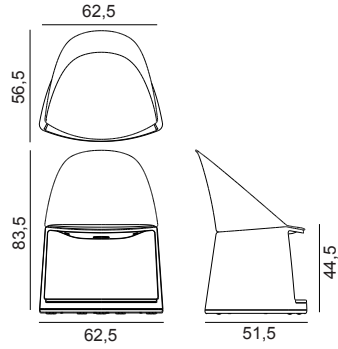

<b>SEK ART. 2301</b>	PC	
	4215	
<b>SHIPMENT DETAILS</b>	<b>TECHNICAL SPECIFICATIONS</b>	<b>RESISTANCE TEST</b>
<b>Art.2301</b> 1 pz = 2  - kg 17,39/ m³ 0,291 4 pz = 5  - kg 66,61/ m³ 0,855 	<b>Art.2301</b> *Classe 1, 2, 11M: fire retardant version available with surcharge and eventual minimum batch	<ul style="list-style-type: none"> <li>TUV GS (EN16139)</li> </ul>
<b>FIRE RETARDANT TEST</b>		
• FIRE RETARDANT VERSION WITH SURCHARGE * Classe 2 Omologazione Italia Polipropilene.		

## Frame Base



## Shell





# Cila Go

Design by Lievore Altherr, 2018

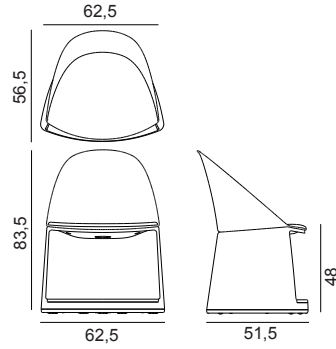

Chair on polypropylene storage base, available in 4 colours, with castors. Polypropylene shell available in 5 colours fitted with cushion applied to the seat in fabric, leather, coated fabric, or customer's material.

Accessories:  
Writing tablet 50x33,5 cm Art. 2307

SEK ART. 2302	A	B COM	C COL	D	E	F	G	H	I	J	K	L	M	ES
	5204	5299	5394	5489	5584	5679	5774	5869	5964	6059	6154	6249	6344	6775
<b>SHIPMENT DETAILS</b>	<b>TECHNICAL SPECIFICATIONS</b>				<b>RESISTANCE TEST</b>									
<b>Art.2302</b> 1 pz = 2  - kg 19,57/ m³ 0,331 4 pz = 5  - kg 71,45/ m³ 0,93 KD	<b>Art.2302</b> COL requirement m² 0.756 H 140 cm. COM Meterage m 0.41				• TUV GS (EN16139)									
<b>FIRE RETARDANT TEST</b>														
Classe 1IM Omologazione Italia Field Kvadrat. Remix 3 Kvadrat. Steelcut 2 Kvadrat. Steelcut Trio 3 Kvadrat. Coated fabric Valencia Spradling.														

## Frame Base



## Shell



# Cila Go

Design by Lievore Altherr, 2018

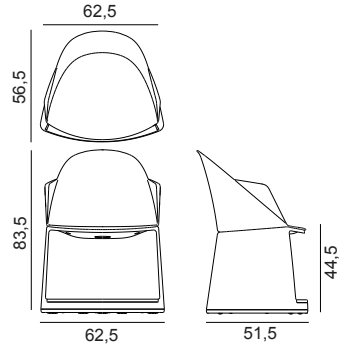

Armchair on polypropylene storage base with castors, available in 4 colours. Polypropylene shell available in 5 colours.

Accessories:  
Writing tablet 50x33,5 cm Art. 2307

<b>SEK ART. 2304</b>	PC	
	4573	
<b>SHIPMENT DETAILS</b>	<b>TECHNICAL SPECIFICATIONS</b>	<b>RESISTANCE TEST</b>
<b>Art.2304</b> 1 pz = 2  - kg 17,83/ m³ 0,314 4 pz = 5  - kg 67,67/ m³ 0,88 	<b>Art.2304</b> *Classe 1, 2, 11M: fire retardant version available with surcharge and eventual minimum batch	<ul style="list-style-type: none"> <li>• EN 1728:2012 - EN 16139:2013 6.17</li> <li>• EN 1728:2012 - EN 16139:2013 6.20</li> <li>• EN 1728:2012 - EN 16139:2013 6.25</li> <li>• EN 1728:2012 - EN 16139:2013 6.4</li> <li>• TÜV GS (EN16139)</li> <li>• ANSI/BIFMA X5.1-2017/6</li> <li>• ANSI/BIFMA X5.1-2017/10</li> <li>• ANSI/BIFMA X5.1-2017/12</li> <li>• ANSI/BIFMA X5.1-2017/15</li> <li>• ANSI/BIFMA X5.1-2017/20</li> </ul>
<b>FIRE RETARDANT TEST</b> • FIRE RETARDANT VERSION WITH SURCHARGE * Classe 2 Omologazione Italia Polipropilene.		

## Frame Base



## Shell



# Cila Go

Design by Lievore Altherr, 2018

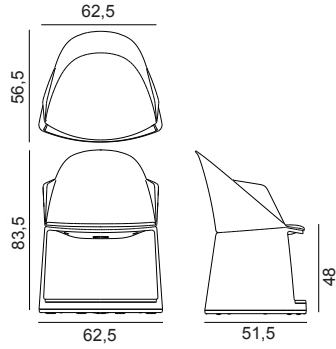

Armchair on polypropylene storage base with castors, available in 4 colours. Polypropylene shell available in 5 colours with seat cushion in fabric, leather, coated fabric, or customer's material.

Accessories:  
Writing tablet 50x33,5 cm Art. 2307

SEK ART. 2305	A	B COM	C COL	D	E	F	G	H	I	J	K	L	M	ES
	5549	5644	5739	5834	5929	6024	6119	6214	6309	6404	6499	6594	6689	7133
<b>SHIPMENT DETAILS</b>	<b>TECHNICAL SPECIFICATIONS</b>				<b>RESISTANCE TEST</b>									
<b>Art.2305</b> 1 pz = 2  - kg 19,74/ m³ 0,391 4 pz = 5  - kg 72,95/ m³ 0,993 KD	<b>Art.2305</b> COL requirement m² 0.756 H 140 cm. COM Meterage m 0.41				• TUV GS (EN16139)									
<b>FIRE RETARDANT TEST</b>														
Classe 1IM Omologazione Italia Field Kvadrat. Remix 3 Kvadrat. Steelcut 2 Kvadrat. Steelcut Trio 3 Kvadrat. Coated fabric Valencia Spradling.														

## Frame Base



## Shell





## Accessories

Design by Lievore Altherr, 2018

Writing tablet in black or white HPL 50 x 33.5 cm and rotating arm in the same colour as the tablet.



<b>SEK ART. 2307</b>	-	
Writing tablet	2131	
<b>SHIPMENT DETAILS</b>	<b>TECHNICAL SPECIFICATIONS</b>	<b>RESISTANCE TEST</b>
Art.2307 1 pz = 1  - kg 5/ m³ 0,021 		• EN 1728:2012 - EN 16139:2013 6.14      • EN 1728:2012 - EN 16139:2013 6.22
<b>FIRE RETARDANT TEST</b>		



# Cila Go

Design by Lievore Altherr, 2019

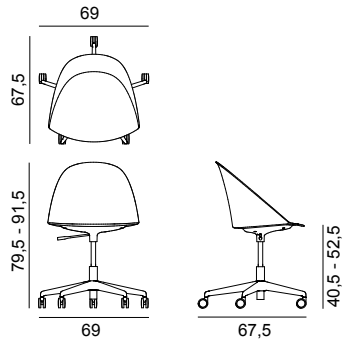

Chair on a 5 way reinforced nylon fibre swivel base (black or white) mounted on self-braking castors (in the same colour as the base). Polypropylene shell available in 5 colours.

<b>SEK ART. 2308</b>	PC	
	4024	
<b>SHIPMENT DETAILS</b>	<b>TECHNICAL SPECIFICATIONS</b>	<b>RESISTANCE TEST</b>
<b>Art.2308</b> 1 pz = 2  - kg 11,43/ m³ 0,21 4 pz = 5  - kg 42,77/ m³ 0,531 	<b>Art.2308</b> *Classe 1, 2, 11M: fire retardant version available with surcharge and eventual minimum batch	<ul style="list-style-type: none"> <li>TUV GS (EN16139)</li> </ul>
<b>FIRE RETARDANT TEST</b>		
• FIRE RETARDANT VERSION WITH SURCHARGE * Classe 2 Omologazione Italia Polipropilene.		

Frame Base



PA00001 PA00002



Shell



PC00001 PC00002 PC00003 PC00004 PC00005



# Cila Go

Design by Lievore Altherr, 2019

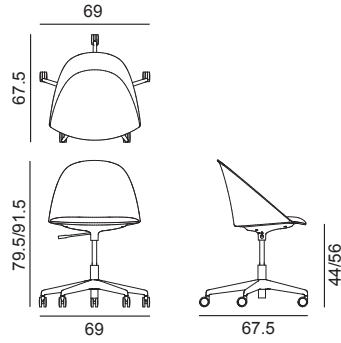

Chair on a 5 way reinforced nylon fibre swivel base (black or white) mounted on self-braking castors (in the same colour as the base). Polypropylene shell available in 5 colours fitted with cushion applied to the seat in fabric, leather, coated fabric, or customer's material.

SEK ART. 2309	A	B COM	C COL	D	E	F	G	H	I	J	K	L	M	ES
	5013	5108	5203	5298	5393	5488	5583	5678	5773	5868	5963	6058	6153	6584
<b>SHIPMENT DETAILS</b>		<b>TECHNICAL SPECIFICATIONS</b>				<b>RESISTANCE TEST</b>								
<b>Art.2309</b> 1 pz = 2  - kg 13,61/ m³ 0,25 4 pz = 5  - kg 47,61/ m³ 0,606 		<b>Art.2309</b> COL requirement m² 0.756 H 140 cm. COM Meterage m 0.41				• TUV GS (EN16139)								
<b>FIRE RETARDANT TEST</b>														
Classe 11M Omologazione Italia Field Kvadrat. Remix 3 Kvadrat. Steelcut 2 Kvadrat. Steelcut Trio 3 Kvadrat. Coated fabric Valencia Spradling.														

Frame Base



Shell



# Cila Go

Design by Lievore Altherr, 2019

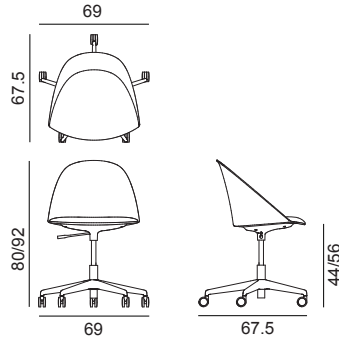

Chair on a 5 way reinforced nylon fibre swivel base (black or white) mounted on self-braking castors (in the same colour as the base). Shell fully upholstered in leather, coated fabric, fabric or customer's own material.

SEK ART. 2316	A	B COM	C COL	D	E	F	G	H	I	J	K	L	M	ES
	7025	7335	7645	7955	8265	8575	8885	9195	9505	9815	10125	10435	10745	12192

SHIPMENT DETAILS	TECHNICAL SPECIFICATIONS	RESISTANCE TEST
<b>Art.2316</b> 1 pz = 2  - kg 14,11/ m³ 0,25 4 pz = 5  - kg 49,61/ m³ 0,606 KD	<b>Art.2316</b> COL requirement m² 3 H 140 cm. COM Meterage m 1.31 *Classe 1, 2, 1IM: fire retardant version available with surcharge and eventual minimum batch	• TUV GS (EN16139)
<b>FIRE RETARDANT TEST</b> Classe 1IM Omologazione Italia Field Kvadrat. Remix 3 Kvadrat. Steelcut 2 Kvadrat. Coated fabric Valencia Spradling. • FIRE RETARDANT VERSION WITH SURCHARGE * Classe 1IM Omologazione Italia Steelcut Trio 3 Kvadrat.		

Frame Base



# Cila Go

Design by Lievore Altherr, 2019

Armchair on a 5 way reinforced nylon fibre swivel base (black or white) mounted on self-braking castors (in the same colour as the base). Polypropylene shell available in 5 colours.

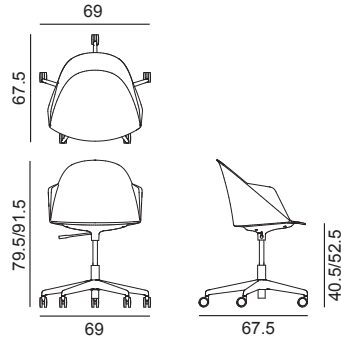

<b>SEK ART. 2310</b>	PC	
	4382	
<b>SHIPMENT DETAILS</b>	<b>TECHNICAL SPECIFICATIONS</b>	<b>RESISTANCE TEST</b>
<b>Art.2310</b> 1 pz = 2  - kg 11,87/ m³ 0,233 4 pz = 5  - kg 43,83/ m³ 0,556 	<b>Art.2310</b> *Classe 1, 2, 11M: fire retardant version available with surcharge and eventual minimum batch	<ul style="list-style-type: none"> <li>• EN 1728:2012 - EN 16139:2013 6.10</li> <li>• EN 1728:2012 - EN 16139:2013 6.17</li> <li>• EN 1728:2012 - EN 16139:2013 6.20</li> <li>• EN 1728:2012 - EN 16139:2013 6.25</li> <li>• EN 1728:2012 - EN 16139:2013 6.4</li> <li>• TUV GS (EN16139)</li> <li>• EN 1022:2018</li> </ul> <ul style="list-style-type: none"> <li>• EN 1728:2012 - EN 16139:2013 6.11</li> <li>• EN 1728:2012 - EN 16139:2013 6.18</li> <li>• EN 1728:2012 - EN 16139:2013 6.24</li> <li>• EN 1728:2012 - EN 16139:2013 6.26</li> <li>• EN 1728:2012 - EN 16139:2013 6.5</li> <li>• EN 1728:2012 - EN 16139:2013 6. 6</li> </ul>
<b>FIRE RETARDANT TEST</b>		

Frame Base



Shell





# Cila Go

Design by Lievore Altherr, 2019

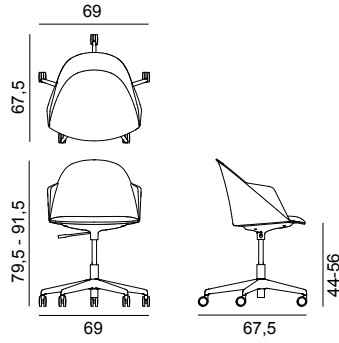

Armchair on a 5 way reinforced nylon fibre swivel base (black or white) mounted on self-braking castors (in the same colour as the base). Polypropylene shell available in 5 colours with seat cushion in fabric, leather, coated fabric, or customer's material.

SEK ART. 2311	A	B COM	C COL	D	E	F	G	H	I	J	K	L	M	ES
	5358	5453	5548	5643	5738	5833	5928	6023	6118	6213	6308	6403	6498	6942
<b>SHIPMENT DETAILS</b>	<b>TECHNICAL SPECIFICATIONS</b>				<b>RESISTANCE TEST</b>									
<b>Art.2311</b> 1 pz = 2  - kg 13,78/ m³ 0,31 4 pz = 5  - kg 49,11/ m³ 0,669 KD	<b>Art.2311</b> COL requirement m² 0.756 H 140 cm. COM Meterage m 0.41				• TUV GS (EN16139)									
<b>FIRE RETARDANT TEST</b>														
Classe 1IM Omologazione Italia Field Kvadrat. Remix 3 Kvadrat. Steelcut 2 Kvadrat. Steelcut Trio 3 Kvadrat. Coated fabric Valencia Spradling.														

Frame Base



Shell



# Cila Go

Design by Lievore Altherr, 2019

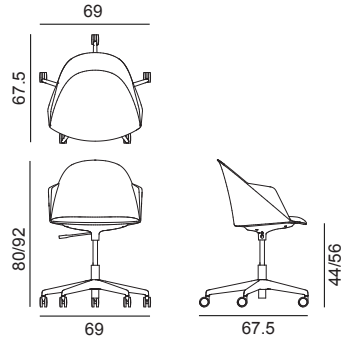

Armchair on a 5 way nylon fibre reinforced swivel base (black or white) mounted on self-braking castors (in the same colour as the base). Shell fully upholstered in leather, coated fabric, fabric or customer's own material.

SEK ART. 2318	A	B COM	C COL	D	E	F	G	H	I	J	K	L	M	ES
	7382	7799	8216	8633	9050	9467	9884	10301	10718	11135	11552	11969	12386	13884
SHIPMENT DETAILS	TECHNICAL SPECIFICATIONS				RESISTANCE TEST									
<b>Art.2318</b> 1 pz = 2  - kg 14,75/ m³ 0,31 4 pz = 5  - kg 53/ m³ 0,669 KD	<b>Art.2318</b> COL requirement m² 3.3 H 140 cm. COM Meterage m 1.47 *Classe 1, 2, 1IM: fire retardant version available with surcharge and eventual minimum batch				• TUV GS (EN16139)									
FIRE RETARDANT TEST														
Classe 1IM Omologazione Italia Field Kvadrat. Remix 3 Kvadrat. Steelcut 2 Kvadrat. Coated fabric Valencia Spradling. • FIRE RETARDANT VERSION WITH SURCHARGE * Classe 1IM Omologazione Italia Steelcut Trio 3 Kvadrat.														

Frame Base



# Cila Go

Design by Lievore Altherr, 2019

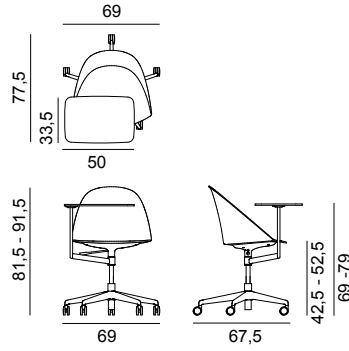

Chair on a 5 way reinforced nylon fibre swivel base (black or white) mounted on self-braking castors (in the same colour as the base) and complete with writing tablet 50x33.5 cm in HPL with top and rotating arm in the same colour as the base. Polypropylene shell available in 5 colours.

<b>SEK ART. 2312</b>	PC	
	6155	
<b>SHIPMENT DETAILS</b>	<b>TECHNICAL SPECIFICATIONS</b>	<b>RESISTANCE TEST</b>
<b>Art.2312</b> 1 pz = 3  - kg 16,43/ m³ 0,231 4 pz = 9  - kg 62,77/ m³ 0,613 	<b>Art.2312</b> *Classe 1, 2, 11M: fire retardant version available with surcharge and eventual minimum batch	<ul style="list-style-type: none"> <li>TUV GS (EN16139)</li> </ul>
<b>FIRE RETARDANT TEST</b>		
* FIRE RETARDANT VERSION WITH SURCHARGE * Classe 2 Omologazione Italia Polipropilene.		

Frame Base



PA00001 PA00002



Shell



PC00001 PC00002 PC00003 PC00004 PC00005



# Cila Go

Design by Lievore Altherr, 2019

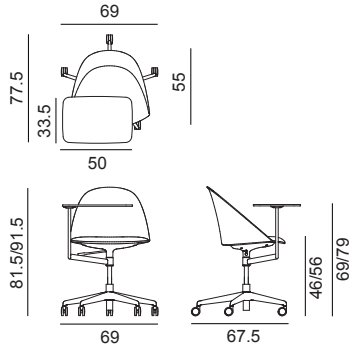

Chair on a 5 way reinforced nylon fibre swivel base (black or white) mounted on self-braking castors (in the same colour as the base) and complete with writing tablet 50x33.5 cm in HPL with top and rotating arm in the same colour as the base. Polypropylene shell available in five colors, with seat cushion in leather, coated fabric, fabric or customer's own material.

SEK ART. 2313	A	B COM	C COL	D	E	F	G	H	I	J	K	L	M	ES
	7144	7239	7334	7429	7524	7619	7714	7809	7904	7999	8094	8189	8284	8715
SHIPMENT DETAILS	TECHNICAL SPECIFICATIONS				RESISTANCE TEST									
<b>Art.2313</b> 1 pz = 3  - kg 18,61/ m³ 0,27 4 pz = 9  - kg 67,61/ m³ 0,688 	<b>Art.2313</b> COL requirement m² 0.756 H 140 cm. COM Meterage m 0.41				• TUV GS (EN16139)									
FIRE RETARDANT TEST														
Classe 1IM Omologazione Italia Field Kvadrat. Remix 3 Kvadrat. Steelcut 2 Kvadrat. Steelcut Trio 3 Kvadrat. Coated fabric Valencia Spradling.														

Frame Base



Shell



# Cila Go

Design by Lievore Altherr, 2019

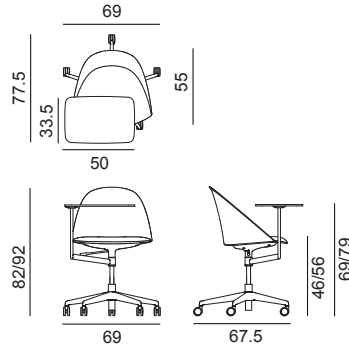

Chair on a 5 way reinforced nylon fibre swivel base (black or white) mounted on self-braking castors (in the same colour as the base) and complete with writing tablet 50x33.5 cm in HPL with top and rotating arm in the same colour as the base. Shell fully upholstered in leather, coated fabric, fabric or customer's own material.

SEK ART. 2317	A	B COM	C COL	D	E	F	G	H	I	J	K	L	M	ES
	9156	9466	9776	10086	10396	10706	11016	11326	11636	11946	12256	12566	12876	14323

SHIPMENT DETAILS	TECHNICAL SPECIFICATIONS	RESISTANCE TEST
<b>Art.2317</b> 1 pz = 3  - kg 19,11/ m³ 0,27 4 pz = 9  - kg 69,61/ m³ 0,688 	<b>Art.2317</b> COL requirement m³ 3 H 140 cm. COM Meterage m 1.31 *Classe 1, 2, 11M: fire retardant version available with surcharge and eventual minimum batch	<ul style="list-style-type: none"> <li>TUV GS (EN16139)</li> </ul>
<b>FIRE RETARDANT TEST</b> Classe 11M Omologazione Italia Field Kvadrat. Remix 3 Kvadrat. Steelcut 2 Kvadrat. Coated fabric Valencia Spradling. * FIRE RETARDANT VERSION WITH SURCHARGE * Classe 11M Omologazione Italia Steelcut Trio 3 Kvadrat.		

Frame Base



# Cila Go

Design by Lievore Altherr, 2019

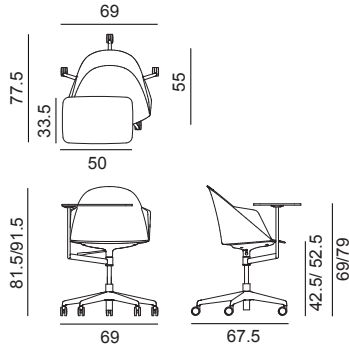

Armchair on a 5 way reinforced nylon fibre swivel base (black or white) mounted on self-braking castors (in the same colour as the base) and complete with writing tablet 50x33.5 cm in HPL with top and rotating arm in the same colour as the base. Polypropylene shell available in 5 colours.

<b>SEK ART. 2314</b>	PC	
	6513	
<b>SHIPMENT DETAILS</b>	<b>TECHNICAL SPECIFICATIONS</b>	<b>RESISTANCE TEST</b>
<b>Art.2314</b> 1 pz = 3  - kg 16,87/ m³ 0,253 4 pz = 9  - kg 63,83/ m³ 0,638 	<b>Art.2314</b> *Classe 1, 2, 11M: fire retardant version available with surcharge and eventual minimum batch	<ul style="list-style-type: none"> <li>TUV GS (EN16139)</li> </ul>
<b>FIRE RETARDANT TEST</b>		
• FIRE RETARDANT VERSION WITH SURCHARGE * Classe 2 Omologazione Italia Polipropilene.		

## Frame Base



PA00001 PA00002



## Shell



PC00001 PC00002 PC00003 PC00004 PC00005



# Cila Go

Design by Lievore Altherr, 2019

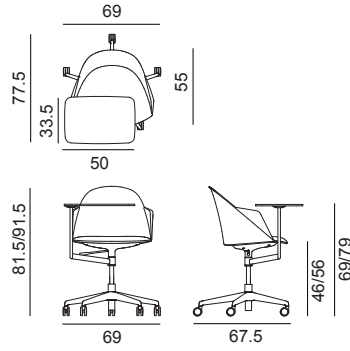

Armchair on a 5 way reinforced nylon fibre swivel base (black or white) mounted on self-braking castors (in the same colour as the base) and complete with writing tablet 50x33.5 cm in HPL with top and rotating arm in the same colour as the base. Polypropylene shell available in five colours, with seat cushion in leather, coated fabric, fabric or customer's own material.

SEK ART. 2315	A	B COM	C COL	D	E	F	G	H	I	J	K	L	M	ES
	7489	7584	7679	7774	7869	7964	8059	8154	8249	8344	8439	8534	8629	9073
<b>SHIPMENT DETAILS</b>	<b>TECHNICAL SPECIFICATIONS</b>				<b>RESISTANCE TEST</b>									
<b>Art.2315</b> 1 pz = 3  - kg 18,78/ m³ 0,331 4 pz = 9  - kg 69,11/ m³ 0,751 KD	<b>Art.2315</b> COL requirement m² 0.756 H 140 cm. COM Meterage m 0.41				• TUV GS (EN16139)									
<b>FIRE RETARDANT TEST</b>														
Classe 1IM Omologazione Italia Field Kvadrat. Remix 3 Kvadrat. Steelcut 2 Kvadrat. Steelcut Trio 3 Kvadrat. Coated fabric Valencia Spradling.														

Frame Base



Shell



# Cila Go

Design by Lievore Altherr, 2019

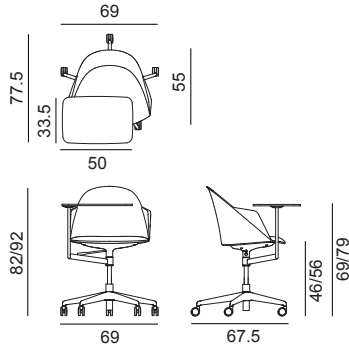

Armchair on a 5 way reinforced nylon fibre swivel base (black or white) mounted on self-braking castors (in the same colour as the base) and complete with writing tablet 50x33.5 cm in HPL with top and rotating arm in the same colour as the base. Shell fully upholstered in leather, coated fabric, fabric or customer's own material.

SEK ART. 2319	A	B COM	C COL	D	E	F	G	H	I	J	K	L	M	ES
	9513	9930	10347	10764	11181	11598	12015	12432	12849	13266	13683	14100	14517	16015

SHIPMENT DETAILS	TECHNICAL SPECIFICATIONS	RESISTANCE TEST
<b>Art.2319</b> 1 pz = 3  - kg 19,75/ m² 0,331 4 pz = 9  - kg 73/ m² 0,751 KD	<b>Art.2319</b> COL requirement m² 3.3 H 140 cm. COM Meterage m 1.47 *Classe 1, 2, 1IM: fire retardant version available with surcharge and eventual minimum batch	• TUV GS (EN16139)
<b>FIRE RETARDANT TEST</b> Classe 1IM Omologazione Italia Field Kvadrat. Remix 3 Kvadrat. Steelcut 2 Kvadrat. Coated fabric Valencia Spradling. • FIRE RETARDANT VERSION WITH SURCHARGE * Classe 1IM Omologazione Italia Steelcut Trio 3 Kvadrat.		

Frame Base







# DUNA 02

---

Design by  
Lievore Altherr Molina  
2000 — New Edition 2014



# Duna 02

## Collection overview

### Bases



4 legs



4 legs lounge



4 wood legs



Sled



4 ways swivel



Aluminum trestle swivel



Aluminum trestle fixed



Aluminum 5 ways

### Shells



Polypropylene



Polypropylene with seat cushion



Polypropylene with front upholstery



Upholstered with non-removable cover

# Duna 02

Design by Lievore Altherr Molina, 2014

Chair with chromed or powdercoated steel four-leg base.  
Polypropylene shell available in 4 colors.

Accessories:  
Set of glides Art. 2015

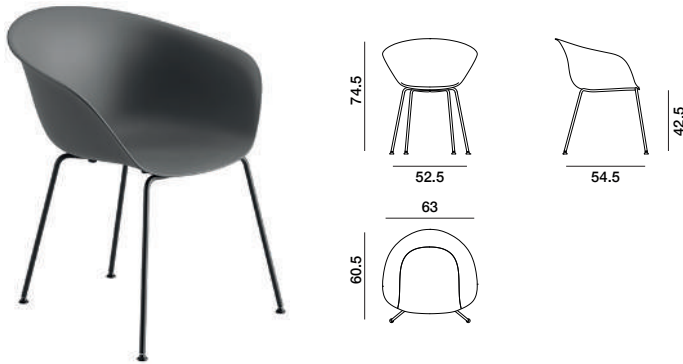

<b>SEK ART. 4201</b>	PP	
CHROMED / POWDERCOATED	2560	
Polypropylene fire retardant	+ 441	(For all finishes qty min. 300 pcs)
<b>SHIPMENT DETAILS</b>	<b>TECHNICAL SPECIFICATIONS</b>	<b>RESISTANCE TEST</b>
<b>Art.4201</b> 1 pz = 2  - kg 12,88/ m³ 0,355 4 pz = 2  - kg 37,7/ m³ 0,484 	<b>Art.4201</b> *Classe 1, 2, 11M: fire retardant version available with surcharge and eventual minimum batch	<ul style="list-style-type: none"> <li>• EN 1728:2012 - EN 16139:2013 6.10</li> <li>• EN 1728:2012 - EN 16139:2013 6.15</li> <li>• EN 1728:2012 - EN 16139:2013 6.17</li> <li>• EN 1728:2012 - EN 16139:2013 6.20</li> <li>• EN 1728:2012 - EN 16139:2013 6.25</li> <li>• EN 1728:2012 - EN 16139:2013 6.4</li> </ul> <ul style="list-style-type: none"> <li>• EN 1728:2012 - EN 16139:2013 6.11</li> <li>• EN 1728:2012 - EN 16139:2013 6.16</li> <li>• EN 1728:2012 - EN 16139:2013 6.18</li> <li>• EN 1728:2012 - EN 16139:2013 6.24</li> <li>• EN 1728:2012 - EN 16139:2013 6.26</li> <li>• EN 1728:2012 - EN 16139:2013 6.5</li> </ul>
<b>FIRE RETARDANT TEST</b>		
* FIRE RETARDANT VERSION WITH SURCHARGE * Classe 2 Omologazione Italia Polipropilene.		

## Frame Base



## Shell



# Duna 02

Design by Lievore Altherr Molina, 2014

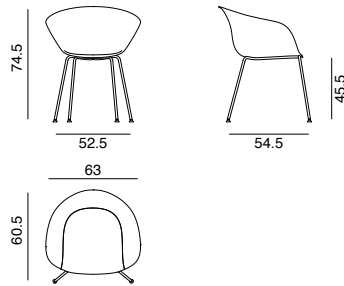

Chair with chromed or powdercoated steel four-leg base. Polypropylene shell available in 4 colors, with seat cushion in leather, coated fabric, fabric or customer's own material.

Accessories:  
Set of glides Art. 2015

SEK ART. 4221	A	B COM	C COL	D	E	F	G	H	I	J	K	L	M	ES
CHROMED / POWDERCOATED	3417	3560	3703	3846	3989	4132	4275	4418	4561	4704	4847	4990	5133	5810
<b>SHIPMENT DETAILS</b>		<b>TECHNICAL SPECIFICATIONS</b>				<b>RESISTANCE TEST</b>								
<b>Art.4221</b> 1 pz = 2  - kg 12,88/ m³ 0,355 4 pz = 2  - kg 37,7/ m³ 0,484 		<b>Art.4221</b> COL requirement m² 0.56 H 140 cm. COM Meterage m 0.7				<ul style="list-style-type: none"> <li>• EN 1728:2012 - EN 16139:2013 6.10</li> <li>• EN 1728:2012 - EN 16139:2013 6.15</li> <li>• EN 1728:2012 - EN 16139:2013 6.17</li> <li>• EN 1728:2012 - EN 16139:2013 6.20</li> <li>• EN 1728:2012 - EN 16139:2013 6.25</li> <li>• EN 1728:2012 - EN 16139:2013 6.4</li> </ul>				<ul style="list-style-type: none"> <li>• EN 1728:2012 - EN 16139:2013 6.11</li> <li>• EN 1728:2012 - EN 16139:2013 6.16</li> <li>• EN 1728:2012 - EN 16139:2013 6.18</li> <li>• EN 1728:2012 - EN 16139:2013 6.24</li> <li>• EN 1728:2012 - EN 16139:2013 6.26</li> <li>• EN 1728:2012 - EN 16139:2013 6.5</li> </ul>				
<b>FIRE RETARDANT TEST</b>														
Classe 1IM Omologazione Italia Field Kvadrat. Remix 3 Kvadrat. Steelcut 2 Kvadrat. Steelcut Trio 3 Kvadrat. Coated fabric Valencia Spradling.														

## Frame Base



## Shell



# Duna 02

Design by Lievore Altherr Molina, 2014

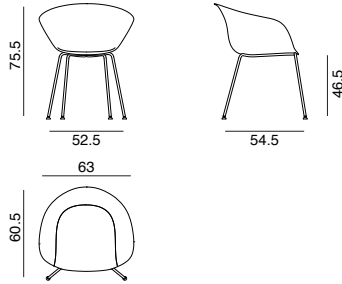

Chair with chromed or powdercoated steel four-leg base and polypropylene shell available in 4 colors, with front upholstery in leather, coated fabric, fabric or customer's own material.

Accessories:  
Set of glides Art. 2015

SEK ART. 4211	A	B COM	C COL	D	E	F	G	H	I	J	K	L	M	ES
CHROMED / POWDERCOATED	5097	5466	5835	6204	6573	6942	7311	7680	8049	8418	8787	9156	9525	10812

SHIPMENT DETAILS	TECHNICAL SPECIFICATIONS	RESISTANCE TEST
<b>Art.4211</b> 1 pz = 2  - kg 12,88/ m³ 0,355 4 pz = 2  - kg 37,71 m³ 0,484 	<b>Art.4211</b> COL requirement m² 1.44 H 140 cm. COM Meterage m 1.05	<ul style="list-style-type: none"> <li>• EN 1728:2012 - EN 16139:2013 6.10</li> <li>• EN 1728:2012 - EN 16139:2013 6.15</li> <li>• EN 1728:2012 - EN 16139:2013 6.17</li> <li>• EN 1728:2012 - EN 16139:2013 6.20</li> <li>• EN 1728:2012 - EN 16139:2013 6.25</li> <li>• EN 1728:2012 - EN 16139:2013 6.4</li> </ul> <ul style="list-style-type: none"> <li>• EN 1728:2012 - EN 16139:2013 6.11</li> <li>• EN 1728:2012 - EN 16139:2013 6.16</li> <li>• EN 1728:2012 - EN 16139:2013 6.18</li> <li>• EN 1728:2012 - EN 16139:2013 6.24</li> <li>• EN 1728:2012 - EN 16139:2013 6.26</li> <li>• EN 1728:2012 - EN 16139:2013 6.5</li> </ul>

FIRE RETARDANT TEST
Classe 1IM Omologazione Italia Field Kvadrat. Remix 3 Kvadrat. Steelcut Trio 3 Kvadrat. Coated fabric Valencia Spradling.

## Frame Base



## Shell



# Duna 02

Design by Lievore Altherr Molina, 2014

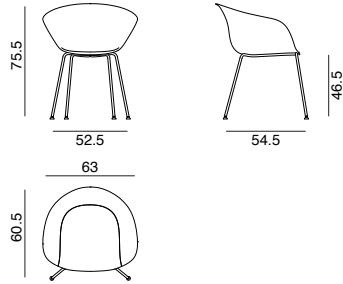

Chair with chromed or powdercoated steel four leg base. Shell fully upholstered in leather, coated fabric, fabric or customer's own material.

SEK ART. 4231	A	B COM	C COL	D	E	F	G	H	I	J	K	L	M	ES
CHROMED / POWDERCOATED	5251	5751	6251	6751	7251	7751	8251	8751	9251	9751	10251	10751	11251	13122
<b>SHIPMENT DETAILS</b>		<b>TECHNICAL SPECIFICATIONS</b>				<b>RESISTANCE TEST</b>								
<b>Art.4231</b> 1 pz = 2  - kg 12,88/ m³ 0,355 4 pz = 2  - kg 30,7/ m³ 0,484 		<b>Art.4231</b> COL requirement m² 2.66 H 140 cm. COM Meterage m 1.72				<ul style="list-style-type: none"> <li>• EN 1728:2012 - EN 16139:2013 6.10</li> <li>• EN 1728:2012 - EN 16139:2013 6.15</li> <li>• EN 1728:2012 - EN 16139:2013 6.17</li> <li>• EN 1728:2012 - EN 16139:2013 6.20</li> <li>• EN 1728:2012 - EN 16139:2013 6.25</li> <li>• EN 1728:2012 - EN 16139:2013 6.4</li> </ul>				<ul style="list-style-type: none"> <li>• EN 1728:2012 - EN 16139:2013 6.11</li> <li>• EN 1728:2012 - EN 16139:2013 6.16</li> <li>• EN 1728:2012 - EN 16139:2013 6.18</li> <li>• EN 1728:2012 - EN 16139:2013 6.24</li> <li>• EN 1728:2012 - EN 16139:2013 6.26</li> <li>• EN 1728:2012 - EN 16139:2013 6.5</li> </ul>				
<b>FIRE RETARDANT TEST</b>														

Frame Base



# Duna 02 Lounge

Design by Lievore Altherr Molina, 2014

Lounge chair with chromed steel four-leg base. Polypropylene shell available in 4 colors.

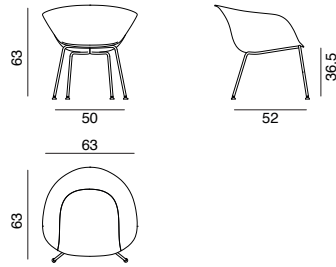

Accessories:  
Set of glides Art. 2015

<b>SEK ART. 4202</b>	PP	
CHROMED	2560	
Polypropylene fire retardant	+ 441	(For all finishes qty min. 300 pcs)
<b>SHIPMENT DETAILS</b>	<b>TECHNICAL SPECIFICATIONS</b>	<b>RESISTANCE TEST</b>
<b>Art.4202</b> 1 pz = 2  - kg 12,62/ m³ 0,355 4 pz = 2  - kg 37,18/ m³ 0,484 	<b>Art.4202</b> *Classe 1, 2, 11M: fire retardant version available with surcharge and eventual minimum batch	<ul style="list-style-type: none"> <li>• EN 1728:2012 - EN 16139:2013 6.10</li> <li>• EN 1728:2012 - EN 16139:2013 6.15</li> <li>• EN 1728:2012 - EN 16139:2013 6.17</li> <li>• EN 1728:2012 - EN 16139:2013 6.20</li> <li>• EN 1728:2012 - EN 16139:2013 6.25</li> <li>• EN 1728:2012 - EN 16139:2013 6.4</li> </ul> <ul style="list-style-type: none"> <li>• EN 1728:2012 - EN 16139:2013 6.11</li> <li>• EN 1728:2012 - EN 16139:2013 6.16</li> <li>• EN 1728:2012 - EN 16139:2013 6.18</li> <li>• EN 1728:2012 - EN 16139:2013 6.24</li> <li>• EN 1728:2012 - EN 16139:2013 6.26</li> <li>• EN 1728:2012 - EN 16139:2013 6.5</li> </ul>
<b>FIRE RETARDANT TEST</b>		
* FIRE RETARDANT VERSION WITH SURCHARGE * Classe 2 Omologazione Italia Polipropilene.		

Frame Base



CRO



Shell



PP0001 PP0004 PP0005 PP0006





# Duna 02 Lounge

Design by Lievore Altherr Molina, 2014

Lounge chair with chromed steel four-leg base. Polypropylene shell available in 4 colors, with seat cushion in leather, coated fabric, fabric or customer's own material.

Accessories:  
Set of glides Art. 2015

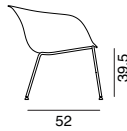
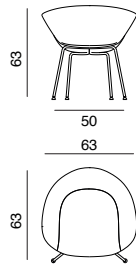

SEK ART. 4222	A	B COM	C COL	D	E	F	G	H	I	J	K	L	M	ES
CHROMED	3417	3560	3703	3846	3989	4132	4275	4418	4561	4704	4847	4990	5133	5810
<b>SHIPMENT DETAILS</b>		<b>TECHNICAL SPECIFICATIONS</b>				<b>RESISTANCE TEST</b>								
<b>Art.4222</b> 1 pz = 2  - kg 12,62/ m³ 0,355 4 pz = 2  - kg 37,18/ m³ 0,484 		<b>Art.4222</b> COL requirement m² 0.56 H 140 cm. COM Meterage m 0.7				<ul style="list-style-type: none"> <li>• EN 1728:2012 - EN 16139:2013 6.10</li> <li>• EN 1728:2012 - EN 16139:2013 6.15</li> <li>• EN 1728:2012 - EN 16139:2013 6.17</li> <li>• EN 1728:2012 - EN 16139:2013 6.20</li> <li>• EN 1728:2012 - EN 16139:2013 6.25</li> <li>• EN 1728:2012 - EN 16139:2013 6.4</li> </ul>			<ul style="list-style-type: none"> <li>• EN 1728:2012 - EN 16139:2013 6.11</li> <li>• EN 1728:2012 - EN 16139:2013 6.16</li> <li>• EN 1728:2012 - EN 16139:2013 6.18</li> <li>• EN 1728:2012 - EN 16139:2013 6.24</li> <li>• EN 1728:2012 - EN 16139:2013 6.26</li> <li>• EN 1728:2012 - EN 16139:2013 6.5</li> </ul>					
<b>FIRE RETARDANT TEST</b>														
Classe 1IM Omologazione Italia Field Kvadrat. Remix 3 Kvadrat. Steelcut 2 Kvadrat. Steelcut Trio 3 Kvadrat. Coated fabric Valencia Spradling.														

Frame Base



CRO



Shell



PP0001 PP0004 PP0005 PP0006



# Duna 02 Lounge

Design by Lievore Altherr Molina, 2014

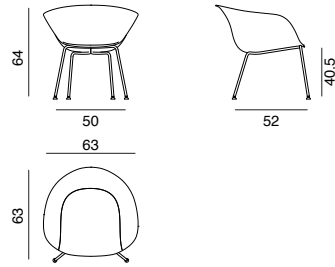

Lounge chair with chromed steel four-leg base and polypropylene shell available in 4 colors, with front upholstery in leather, coated fabric, fabric or customer's own material.

Accessories:  
Set of glides Art. 2015

SEK ART. 4212	A	B COM	C COL	D	E	F	G	H	I	J	K	L	M	ES
CHROMED	5097	5466	5835	6204	6573	6942	7311	7680	8049	8418	8787	9156	9525	10812
<b>SHIPMENT DETAILS</b>		<b>TECHNICAL SPECIFICATIONS</b>				<b>RESISTANCE TEST</b>								
<b>Art.4212</b> 1 pz = 2  - kg 12,62/ m³ 0,355 4 pz = 2  - kg 37,18/ m³ 0,484 		<b>Art.4212</b> COL requirement m² 1.44 H 140 cm. COM Meterage m 1.05				<ul style="list-style-type: none"> <li>EN 1728:2012 - EN 16139:2013 6.10</li> <li>EN 1728:2012 - EN 16139:2013 6.15</li> <li>EN 1728:2012 - EN 16139:2013 6.17</li> <li>EN 1728:2012 - EN 16139:2013 6.20</li> <li>EN 1728:2012 - EN 16139:2013 6.25</li> <li>EN 1728:2012 - EN 16139:2013 6.4</li> </ul>				<ul style="list-style-type: none"> <li>EN 1728:2012 - EN 16139:2013 6.11</li> <li>EN 1728:2012 - EN 16139:2013 6.16</li> <li>EN 1728:2012 - EN 16139:2013 6.18</li> <li>EN 1728:2012 - EN 16139:2013 6.24</li> <li>EN 1728:2012 - EN 16139:2013 6.26</li> <li>EN 1728:2012 - EN 16139:2013 6.5</li> </ul>				
<b>FIRE RETARDANT TEST</b>														
Classe 1IM Omologazione Italia Field Kvadrat. Remix 3 Kvadrat. Steelcut Trio 3 Kvadrat. Coated fabric Valencia Spradling.														

Frame Base



CRO



Shell



PP0001 PP0004 PP0005 PP0006



# Duna 02 Lounge

Design by Lievore Altherr Molina, 2014

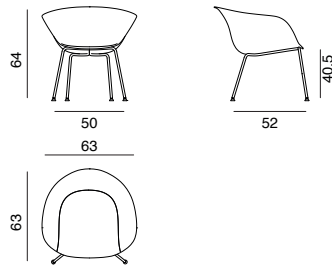

Lounge chair with chromed steel four-leg base. Shell fully upholstered in leather, coated fabric, fabric or customer's own material.

Accessories:  
Set of glides Art. 2015

SEK ART. 4232	A	B COM	C COL	D	E	F	G	H	I	J	K	L	M	ES
CHROMED	5251	5751	6251	6751	7251	7751	8251	8751	9251	9751	10251	10751	11251	13122
<b>SHIPMENT DETAILS</b>		<b>TECHNICAL SPECIFICATIONS</b>				<b>RESISTANCE TEST</b>								
<b>Art.4232</b> 1 pz = 2  - kg 12,62/ m³ 0,355 4 pz = 2  - kg 30,18/ m³ 0,484 KD		<b>Art.4232</b> COL requirement m² 2.66 H 140 cm. COM Meterage m 1.72				<ul style="list-style-type: none"> <li>• EN 1728:2012 - EN 16139:2013 6.10</li> <li>• EN 1728:2012 - EN 16139:2013 6.15</li> <li>• EN 1728:2012 - EN 16139:2013 6.17</li> <li>• EN 1728:2012 - EN 16139:2013 6.20</li> <li>• EN 1728:2012 - EN 16139:2013 6.25</li> <li>• EN 1728:2012 - EN 16139:2013 6.4</li> </ul>				<ul style="list-style-type: none"> <li>• EN 1728:2012 - EN 16139:2013 6.11</li> <li>• EN 1728:2012 - EN 16139:2013 6.16</li> <li>• EN 1728:2012 - EN 16139:2013 6.18</li> <li>• EN 1728:2012 - EN 16139:2013 6.24</li> <li>• EN 1728:2012 - EN 16139:2013 6.26</li> <li>• EN 1728:2012 - EN 16139:2013 6.5</li> </ul>				
<b>FIRE RETARDANT TEST</b>														

Frame Base



CRO



# Duna 02

Design by Lievore Altherr Molina, 2014

Chair with oak veneer four-leg base. Polypropylene shell available in 4 colours.

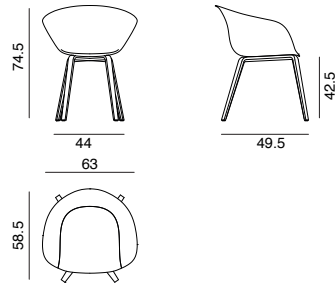

<b>SEK ART. 4203</b>	PP	
WOOD LEGS	3834	
Polypropylene fire retardant	+ 441	(For all finishes qty min. 300 pcs)
<b>SHIPMENT DETAILS</b>	<b>TECHNICAL SPECIFICATIONS</b>	<b>RESISTANCE TEST</b>
<b>Art.4203</b> 1 pz = 2  - kg 12,88/ m³ 0,454 4 pz = 2  - kg 37,7/ m³ 0,447 	<b>Art.4203</b> *Classe 1, 2, 11M: fire retardant version available with surcharge and eventual minimum batch	<ul style="list-style-type: none"> <li>• EN 1728:2012 - EN 16139:2013 6.10</li> <li>• EN 1728:2012 - EN 16139:2013 6.15</li> <li>• EN 1728:2012 - EN 16139:2013 6.17</li> <li>• EN 1728:2012 - EN 16139:2013 6.20</li> <li>• EN 1728:2012 - EN 16139:2013 6.25</li> <li>• EN 1728:2012 - EN 16139:2013 6.4</li> </ul> <ul style="list-style-type: none"> <li>• EN 1728:2012 - EN 16139:2013 6.11</li> <li>• EN 1728:2012 - EN 16139:2013 6.16</li> <li>• EN 1728:2012 - EN 16139:2013 6.18</li> <li>• EN 1728:2012 - EN 16139:2013 6.24</li> <li>• EN 1728:2012 - EN 16139:2013 6.26</li> <li>• EN 1728:2012 - EN 16139:2013 6.5</li> </ul>
<b>FIRE RETARDANT TEST</b>		
* FIRE RETARDANT VERSION WITH SURCHARGE * Classe 2 Omologazione Italia Polipropilene.		

## Frame Base

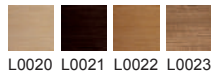

L0020 L0021 L0022 L0023

## Shell



PP0001 PP0004 PP0005 PP0006



# Duna 02

Design by Lievore Altherr Molina, 2014

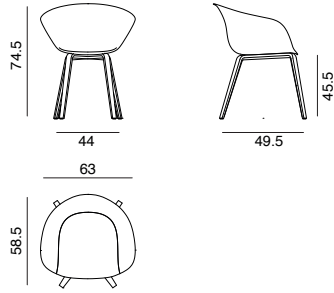

Chair with oak veneer four-leg base. Polypropylene shell available in 4 colours, with seat cushion in leather, coated fabric, fabric or customer's own material.

SEK ART. 4223	A	B COM	C COL	D	E	F	G	H	I	J	K	L	M	ES
WOOD LEGS	4691	4834	4977	5120	5263	5406	5549	5692	5835	5978	6121	6264	6407	7084
<b>SHIPMENT DETAILS</b>	<b>TECHNICAL SPECIFICATIONS</b>				<b>RESISTANCE TEST</b>									
<b>Art.4223</b> 1 pz = 2  - kg 12,88/ m³ 0,355 4 pz = 2  - kg 37,71 m³ 0,484 KD	<b>Art.4223</b> COL requirement m² 0.56 H 140 cm. COM Meterage m 0.7				<ul style="list-style-type: none"> <li>• EN 1728:2012 - EN 16139:2013 6.10</li> <li>• EN 1728:2012 - EN 16139:2013 6.15</li> <li>• EN 1728:2012 - EN 16139:2013 6.17</li> <li>• EN 1728:2012 - EN 16139:2013 6.20</li> <li>• EN 1728:2012 - EN 16139:2013 6.25</li> <li>• EN 1728:2012 - EN 16139:2013 6.4</li> </ul>					<ul style="list-style-type: none"> <li>• EN 1728:2012 - EN 16139:2013 6.11</li> <li>• EN 1728:2012 - EN 16139:2013 6.16</li> <li>• EN 1728:2012 - EN 16139:2013 6.18</li> <li>• EN 1728:2012 - EN 16139:2013 6.24</li> <li>• EN 1728:2012 - EN 16139:2013 6.26</li> <li>• EN 1728:2012 - EN 16139:2013 6.5</li> </ul>				
<b>FIRE RETARDANT TEST</b>														
Classe 1IM Omologazione Italia Field Kvadrat. Remix 3 Kvadrat. Steelcut 2 Kvadrat. Steelcut Trio 3 Kvadrat. Coated fabric Valencia Spradling.														

## Frame Base



L0020 L0021 L0022 L0023

## Shell



PP0001 PP0004 PP0005 PP0006



# Duna 02

Design by Lievore Altherr Molina, 2014

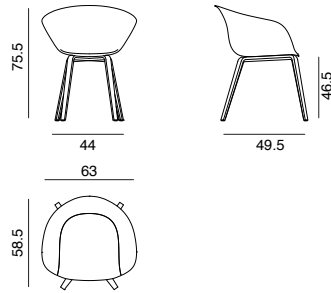

Chair with oak veneer four-leg base and polypropylene shell available in 4 colours, with front upholstery in leather, coated fabric, fabric or customer's own material.

SEK ART. 4213	A	B COM	C COL	D	E	F	G	H	I	J	K	L	M	ES
WOOD LEGS	6371	6740	7109	7478	7847	8216	8585	8954	9323	9692	10061	10430	10799	12086
<b>SHIPMENT DETAILS</b>	<b>TECHNICAL SPECIFICATIONS</b>				<b>RESISTANCE TEST</b>									
<b>Art.4213</b> 1 pz = 2  - kg 12,88/ m³ 0,355 4 pz = 2  - kg 37,71 m³ 0,484 	<b>Art.4213</b> COL requirement m² 1.44 H 140 cm. COM Meterage m 1.05				<ul style="list-style-type: none"> <li>EN 1728:2012 - EN 16139:2013 6.10</li> <li>EN 1728:2012 - EN 16139:2013 6.15</li> <li>EN 1728:2012 - EN 16139:2013 6.17</li> <li>EN 1728:2012 - EN 16139:2013 6.20</li> <li>EN 1728:2012 - EN 16139:2013 6.25</li> <li>EN 1728:2012 - EN 16139:2013 6.4</li> </ul>					<ul style="list-style-type: none"> <li>EN 1728:2012 - EN 16139:2013 6.11</li> <li>EN 1728:2012 - EN 16139:2013 6.16</li> <li>EN 1728:2012 - EN 16139:2013 6.18</li> <li>EN 1728:2012 - EN 16139:2013 6.24</li> <li>EN 1728:2012 - EN 16139:2013 6.26</li> <li>EN 1728:2012 - EN 16139:2013 6.5</li> </ul>				
<b>FIRE RETARDANT TEST</b>														
Classe 1IM Omologazione Italia Field Kvadrat. Remix 3 Kvadrat. Steelcut Trio 3 Kvadrat. Coated fabric Valencia Spradling.														

## Frame Base



L0020 L0021 L0022 L0023



## Shell



PP0001 PP0004 PP0005 PP0006



# Duna 02

Design by Lievore Altherr Molina, 2014

Chair with oak veneer four-leg base. Shell fully upholstered in leather, coated fabric, fabric or customer's own material.

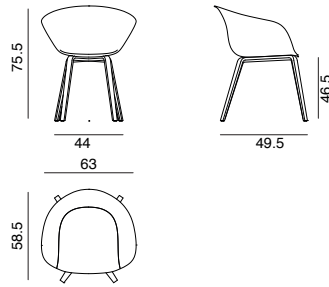

SEK ART. 4233	A	B COM	C COL	D	E	F	G	H	I	J	K	L	M	ES
WOOD LEGS	6525	7025	7525	8025	8525	9025	9525	10025	10525	11025	11525	12025	12525	14396
<b>SHIPMENT DETAILS</b>		<b>TECHNICAL SPECIFICATIONS</b>				<b>RESISTANCE TEST</b>								
<b>Art.4233</b> 1 pz = 2  - kg 12,88/ m³ 0,355 4 pz = 2  - kg 33,94/ m³ 0,484 		<b>Art.4233</b> COL requirement m² 2.66 H 140 cm. COM Meterage m 1.72				<ul style="list-style-type: none"> <li>• EN 1728:2012 - EN 16139:2013 6.10</li> <li>• EN 1728:2012 - EN 16139:2013 6.15</li> <li>• EN 1728:2012 - EN 16139:2013 6.17</li> <li>• EN 1728:2012 - EN 16139:2013 6.20</li> <li>• EN 1728:2012 - EN 16139:2013 6.25</li> <li>• EN 1728:2012 - EN 16139:2013 6.4</li> </ul>				<ul style="list-style-type: none"> <li>• EN 1728:2012 - EN 16139:2013 6.11</li> <li>• EN 1728:2012 - EN 16139:2013 6.16</li> <li>• EN 1728:2012 - EN 16139:2013 6.18</li> <li>• EN 1728:2012 - EN 16139:2013 6.24</li> <li>• EN 1728:2012 - EN 16139:2013 6.26</li> <li>• EN 1728:2012 - EN 16139:2013 6.5</li> </ul>				
<b>FIRE RETARDANT TEST</b>														

Frame Base



# Duna 02

Design by Lievore Altherr Molina, 2014

Chair with chromed or powdercoated steel sled base and polypropylene shell available in 4 colours. Glides for wooden floors available upon request without surcharge.

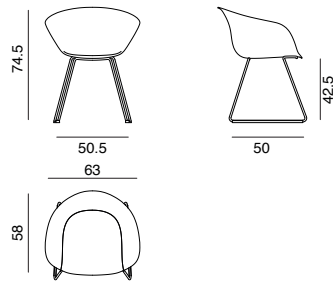

<b>SEK ART. 4200</b>	PP	
CHROMED / POWDERCOATED	3012	
Polypropylene fire retardant	+ 441	(For all finishes qty min. 300 pcs)
<b>SHIPMENT DETAILS</b>	<b>TECHNICAL SPECIFICATIONS</b>	<b>RESISTANCE TEST</b>
<b>Art.4200</b> 1 pz = 2  - kg 12,04/ m³ 0,358 4 pz = 2  - kg 40,44/ m³ 0,472 	<b>Art.4200</b> *Classe 1, 2, 11M: fire retardant version available with surcharge and eventual minimum batch	<ul style="list-style-type: none"> <li>• EN 1728:2012 - EN 16139:2013 6.10</li> <li>• EN 1728:2012 - EN 16139:2013 6.15</li> <li>• EN 1728:2012 - EN 16139:2013 6.17</li> <li>• EN 1728:2012 - EN 16139:2013 6.20</li> <li>• EN 1728:2012 - EN 16139:2013 6.25</li> <li>• EN 1728:2012 - EN 16139:2013 6.4</li> </ul> <ul style="list-style-type: none"> <li>• EN 1728:2012 - EN 16139:2013 6.11</li> <li>• EN 1728:2012 - EN 16139:2013 6.16</li> <li>• EN 1728:2012 - EN 16139:2013 6.18</li> <li>• EN 1728:2012 - EN 16139:2013 6.24</li> <li>• EN 1728:2012 - EN 16139:2013 6.26</li> <li>• EN 1728:2012 - EN 16139:2013 6.5</li> </ul>
<b>FIRE RETARDANT TEST</b>		
* FIRE RETARDANT VERSION WITH SURCHARGE * Classe 2 Omologazione Italia Polipropilene.		

## Frame Base



## Shell



Standard: polycarbonate glide with polyurethane insert.



Upon request: polycarbonate glide with felt insert.





# Duna 02

Design by Lievore Altherr Molina, 2014

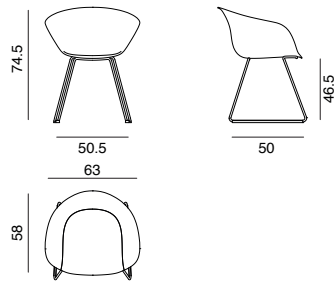

Chair with chromed or powdercoated steel sled base and polypropylene shell available in 4 colors, with cushion in leather, coated fabric, fabric or customer's own material applied on the seat surface. Glides for wooden floors available upon request without surcharge.

SEK ART. 4220	A	B COM	C COL	D	E	F	G	H	I	J	K	L	M	ES
CHROMED / POWDERCOATED	3869	4012	4155	4298	4441	4584	4727	4870	5013	5156	5299	5442	5585	6262
<b>SHIPMENT DETAILS</b>		<b>TECHNICAL SPECIFICATIONS</b>				<b>RESISTANCE TEST</b>								
<b>Art.4220</b> 1 pz = 2  - kg 12,04/ m³ 0,358 4 pz = 2  - kg 40,44/ m³ 0,472 		<b>Art.4220</b> COL requirement m² 0.56 H 140 cm. COM Meterage m 0.7				<ul style="list-style-type: none"> <li>• EN 1728:2012 - EN 16139:2013 6.10</li> <li>• EN 1728:2012 - EN 16139:2013 6.15</li> <li>• EN 1728:2012 - EN 16139:2013 6.17</li> <li>• EN 1728:2012 - EN 16139:2013 6.20</li> <li>• EN 1728:2012 - EN 16139:2013 6.25</li> <li>• EN 1728:2012 - EN 16139:2013 6.4</li> </ul>			<ul style="list-style-type: none"> <li>• EN 1728:2012 - EN 16139:2013 6.11</li> <li>• EN 1728:2012 - EN 16139:2013 6.16</li> <li>• EN 1728:2012 - EN 16139:2013 6.18</li> <li>• EN 1728:2012 - EN 16139:2013 6.24</li> <li>• EN 1728:2012 - EN 16139:2013 6.26</li> <li>• EN 1728:2012 - EN 16139:2013 6.5</li> </ul>					
<b>FIRE RETARDANT TEST</b>														
Classe 1IM Omologazione Italia Field Kvadrat. Remix 3 Kvadrat. Steelcut 2 Kvadrat. Steelcut Trio 3 Kvadrat. Coated fabric Valencia Spradling.														

## Frame Base



## Shell



Standard: polycarbonate glide with polyurethane insert.



Upon request: polycarbonate glide with felt insert.



# Duna 02

Design by Lievore Altherr Molina, 2014

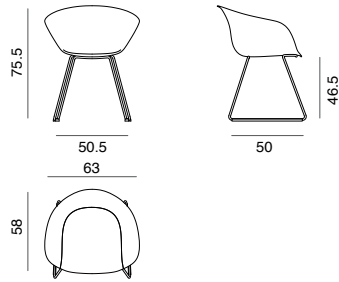

Chair with chromed or powdercoated steel sled base and polypropylene shell available in 4 colors, with front upholstery in leather, coated fabric, fabric or customer's own material. Glides for wooden floors available upon request without surcharge.

SEK ART. 4210	A	B COM	C COL	D	E	F	G	H	I	J	K	L	M	ES
CHROMED / POWDERCOATED	5549	5918	6287	6656	7025	7394	7763	8132	8501	8870	9239	9608	9977	11264
<b>SHIPMENT DETAILS</b>		<b>TECHNICAL SPECIFICATIONS</b>				<b>RESISTANCE TEST</b>								
<b>Art.4210</b> 1 pz = 2  - kg 12,04/ m³ 0,358 4 pz = 2  - kg 40,44/ m³ 0,472 		<b>Art.4210</b> COL requirement m² 1.44 H 140 cm. COM Meterage m 1.05				<ul style="list-style-type: none"> <li>EN 1728:2012 - EN 16139:2013 6.10</li> <li>EN 1728:2012 - EN 16139:2013 6.15</li> <li>EN 1728:2012 - EN 16139:2013 6.17</li> <li>EN 1728:2012 - EN 16139:2013 6.20</li> <li>EN 1728:2012 - EN 16139:2013 6.25</li> <li>EN 1728:2012 - EN 16139:2013 6.4</li> </ul>				<ul style="list-style-type: none"> <li>EN 1728:2012 - EN 16139:2013 6.11</li> <li>EN 1728:2012 - EN 16139:2013 6.16</li> <li>EN 1728:2012 - EN 16139:2013 6.18</li> <li>EN 1728:2012 - EN 16139:2013 6.24</li> <li>EN 1728:2012 - EN 16139:2013 6.26</li> <li>EN 1728:2012 - EN 16139:2013 6.5</li> </ul>				
<b>FIRE RETARDANT TEST</b>														
Classe 1IM Omologazione Italia Field Kvadrat. Remix 3 Kvadrat. Steelcut Trio 3 Kvadrat. Coated fabric Valencia Spradling.														

## Frame Base



## Shell



Standard: polycarbonate glide with polyurethane insert.



Upon request: polycarbonate glide with felt insert.



# Duna 02

Design by Lievore Altherr Molina, 2014

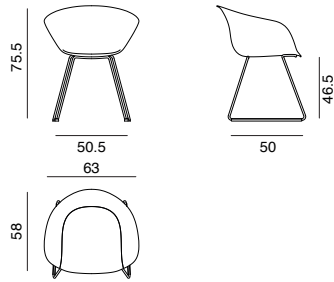

Chair with chromed or powder-coated steel sled base and shell fully upholstered in leather, coated fabric, fabric or customer's own material. Glides for wooden floors available upon request without surcharge.

SEK ART. 4230	A	B COM	C COL	D	E	F	G	H	I	J	K	L	M	ES
CHROMED / POWDERCOATED	5703	6203	6703	7203	7703	8203	8703	9203	9703	10203	10703	11203	11703	13574
<b>SHIPMENT DETAILS</b>		<b>TECHNICAL SPECIFICATIONS</b>				<b>RESISTANCE TEST</b>								
<b>Art.4230</b> 1 pz = 2  - kg 12,04/ m³ 0,358 4 pz = 2  - kg 33,44/ m³ 0,472 KD		<b>Art.4230</b> COL requirement m² 2.66 H 140 cm. COM Meterage m 1.72				<ul style="list-style-type: none"> <li>• EN 1728:2012 - EN 16139:2013 6.10</li> <li>• EN 1728:2012 - EN 16139:2013 6.15</li> <li>• EN 1728:2012 - EN 16139:2013 6.17</li> <li>• EN 1728:2012 - EN 16139:2013 6.20</li> <li>• EN 1728:2012 - EN 16139:2013 6.25</li> <li>• EN 1728:2012 - EN 16139:2013 6.4</li> </ul>			<ul style="list-style-type: none"> <li>• EN 1728:2012 - EN 16139:2013 6.11</li> <li>• EN 1728:2012 - EN 16139:2013 6.16</li> <li>• EN 1728:2012 - EN 16139:2013 6.18</li> <li>• EN 1728:2012 - EN 16139:2013 6.24</li> <li>• EN 1728:2012 - EN 16139:2013 6.26</li> <li>• EN 1728:2012 - EN 16139:2013 6.5</li> </ul>					
<b>FIRE RETARDANT TEST</b>														

Frame Base



Standard: polycarbonate glide with polyurethane insert.



Upon request: polycarbonate glide with felt insert.



# Duna 02

Design by Lievore Altherr Molina, 2014

Chair with chromed steel swivel trestle base and polypropylene shell available in 4 colors.

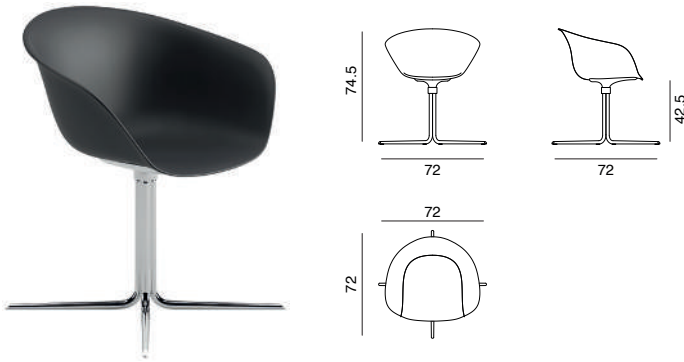

<b>SEK ART. 4205</b>	PP	
CHROMED	4787	
Polypropylene fire retardant	+ 441	(For all finishes qty min. 300 pcs)
<b>SHIPMENT DETAILS</b>	<b>TECHNICAL SPECIFICATIONS</b>	<b>RESISTANCE TEST</b>
<b>Art.4205</b> 1 pz = 2  - kg 16,74/ m³ 0,356 4 pz = 5  - kg 59,24/ m³ 0,924 	<b>Art.4205</b> *Classe 1, 2, 11M: fire retardant version available with surcharge and eventual minimum batch	
<b>FIRE RETARDANT TEST</b>		
* FIRE RETARDANT VERSION WITH SURCHARGE * Classe 2 Omologazione Italia Polipropilene.		

Frame Base



CRO



Shell



PP0001 PP0004 PP0005 PP0006



# Duna 02

Design by Lievore Altherr Molina, 2014

Chair with chromed steel swivel trestle base with polypropylene shell available in 4 colors, with seat cushion in leather, coated fabric, fabric or customer's own material.

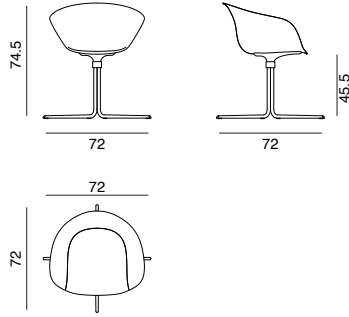

SEK ART. 4225	A	B COM	C COL	D	E	F	G	H	I	J	K	L	M	ES
CHROMED	5644	5787	5930	6073	6216	6359	6502	6645	6788	6931	7074	7217	7360	8037

SHIPMENT DETAILS	TECHNICAL SPECIFICATIONS	RESISTANCE TEST
<b>Art.4225</b> 1 pz = 2  - kg 16,74/ m³ 0,356 4 pz = 5  - kg 59,24/ m³ 0,924 KD	<b>Art.4225</b> COL requirement m² 0.56 H 140 cm. COM Meterage m 0.7	
<b>FIRE RETARDANT TEST</b> Classe 1IM Omologazione Italia Field Kvadrat. Remix 3 Kvadrat. Steelcut 2 Kvadrat. Steelcut Trio 3 Kvadrat. Coated fabric Valencia Spradling.		

Frame Base



CRO

Shell



PP0001 PP0004 PP0005 PP0006



# Duna 02

Design by Lievore Altherr Molina, 2014

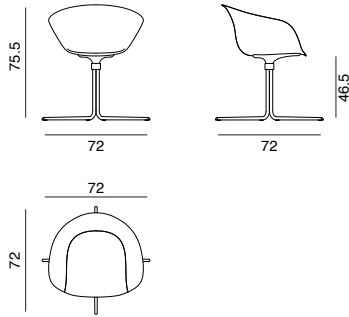

Chair with chromed steel swivel trestle base with polypropylene shell available in 4 colors, with front upholstery in leather, coated fabric, fabric or customer's own material.

SEK ART. 4215	A	B COM	C COL	D	E	F	G	H	I	J	K	L	M	ES
CHROMED	7324	7693	8062	8431	8800	9169	9538	9907	10276	10645	11014	11383	11752	13039
<b>SHIPMENT DETAILS</b>		<b>TECHNICAL SPECIFICATIONS</b>				<b>RESISTANCE TEST</b>								
<b>Art.4215</b> 1 pz = 2  - kg 16,74/ m³ 0,356 4 pz = 5  - kg 59,24/ m³ 0,924 		<b>Art.4215</b> COL requirement m² 1.44 H 140 cm. COM Meterage m 1.05												
<b>FIRE RETARDANT TEST</b>														
Classe 1IM Omologazione Italia Field Kvadrat. Remix 3 Kvadrat. Steelcut Trio 3 Kvadrat. Coated fabric Valencia Spradling.														

Frame Base



CRO



Shell



PP0001 PP0004 PP0005 PP0006



# Duna 02

Design by Lievore Altherr Molina, 2014

Chair with chromed steel swivel trestle base. Shell fully upholstered in leather, coated fabric, fabric or customer's own material.

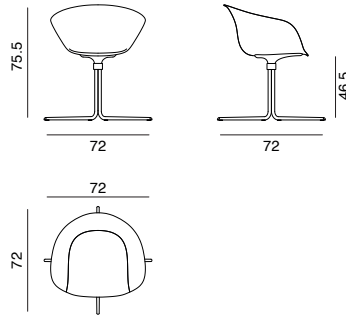

SEK ART. 4235	A	B COM	C COL	D	E	F	G	H	I	J	K	L	M	ES
CHROMED	7478	7978	8478	8978	9478	9978	10478	10978	11478	11978	12478	12978	13478	15349
<b>SHIPMENT DETAILS</b>		<b>TECHNICAL SPECIFICATIONS</b>				<b>RESISTANCE TEST</b>								
<b>Art.4235</b> 1 pz = 2  - kg 16,74/ m³ 0,356 4 pz = 5  - kg 52,24/ m³ 0,924 KD		<b>Art.4235</b> COL requirement m² 2.66 H 140 cm. COM Meterage m 1.72												
<b>FIRE RETARDANT TEST</b>														

Frame Base



CRO



# Duna 02

Design by Lievore Altherr Molina, 2014

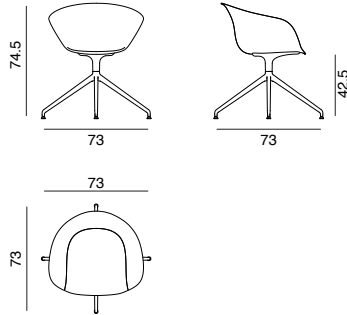

Armchair with polished or powdercoated aluminium swivel trestle base. Polypropylene shell available in 4 colors.

Accessories:  
Set of glides Art. 2015

<b>SEK ART. 4206</b>	PP	
POLISHED / POWDERCOATED	4489	
Polypropylene fire retardant	+ 441	(For all finishes qty min. 300 pcs)
<b>SHIPMENT DETAILS</b>	<b>TECHNICAL SPECIFICATIONS</b>	<b>RESISTANCE TEST</b>
<b>Art.4206</b> 1 pz = 2  - kg 15,28/ m³ 0,367 4 pz = 2  - kg 46,2/ m³ 0,548 	<b>Art.4206</b> *Classe 1, 2, 11M: fire retardant version available with surcharge and eventual minimum batch	<ul style="list-style-type: none"> <li>• EN 1728:2012 - EN 16139:2013 6.10</li> <li>• EN 1728:2012 - EN 16139:2013 6.15</li> <li>• EN 1728:2012 - EN 16139:2013 6.17</li> <li>• EN 1728:2012 - EN 16139:2013 6.20</li> <li>• EN 1728:2012 - EN 16139:2013 6.25</li> <li>• EN 1728:2012 - EN 16139:2013 6.4</li> </ul> <ul style="list-style-type: none"> <li>• EN 1728:2012 - EN 16139:2013 6.11</li> <li>• EN 1728:2012 - EN 16139:2013 6.16</li> <li>• EN 1728:2012 - EN 16139:2013 6.18</li> <li>• EN 1728:2012 - EN 16139:2013 6.24</li> <li>• EN 1728:2012 - EN 16139:2013 6.26</li> <li>• EN 1728:2012 - EN 16139:2013 6.5</li> </ul>
<b>FIRE RETARDANT TEST</b>		
• FIRE RETARDANT VERSION WITH SURCHARGE * Classe 2 Omologazione Italia Polipropilene.		

## Frame Base



## Shell





# Duna 02

Design by Lievore Altherr Molina, 2014

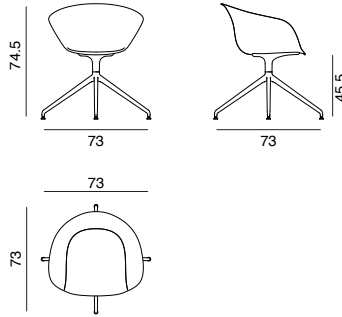

Armchair with polished or powdercoated aluminium swivel trestle base. Polypropylene shell available in 4 colors, with seat cushion in leather, coated fabric, fabric or customer's own material.

Accessories:  
Set of glides Art. 2015

SEK ART. 4226	A	B COM	C COL	D	E	F	G	H	I	J	K	L	M	ES
POLISHED / POWDERCOATED	5346	5489	5632	5775	5918	6061	6204	6347	6490	6633	6776	6919	7062	7739
<b>SHIPMENT DETAILS</b>		<b>TECHNICAL SPECIFICATIONS</b>				<b>RESISTANCE TEST</b>								
<b>Art.4226</b> 1 pz = 2  - kg 15,28/ m³ 0,367 4 pz = 2  - kg 46,2/ m³ 0,548 		<b>Art.4226</b> COL requirement m² 0.56 H 140 cm. COM Meterage m 0.7				<ul style="list-style-type: none"> <li>EN 1728:2012 - EN 16139:2013 6.10</li> <li>EN 1728:2012 - EN 16139:2013 6.15</li> <li>EN 1728:2012 - EN 16139:2013 6.17</li> <li>EN 1728:2012 - EN 16139:2013 6.20</li> <li>EN 1728:2012 - EN 16139:2013 6.25</li> <li>EN 1728:2012 - EN 16139:2013 6.4</li> </ul>				<ul style="list-style-type: none"> <li>EN 1728:2012 - EN 16139:2013 6.11</li> <li>EN 1728:2012 - EN 16139:2013 6.16</li> <li>EN 1728:2012 - EN 16139:2013 6.18</li> <li>EN 1728:2012 - EN 16139:2013 6.24</li> <li>EN 1728:2012 - EN 16139:2013 6.26</li> <li>EN 1728:2012 - EN 16139:2013 6.5</li> </ul>				
<b>FIRE RETARDANT TEST</b>														
Classe 1IM Omologazione Italia Field Kvadrat. Remix 3 Kvadrat. Steelcut 2 Kvadrat. Steelcut Trio 3 Kvadrat. Coated fabric Valencia Spradling.														

## Frame Base



## Shell



# Duna 02

Design by Lievore Altherr Molina, 2014

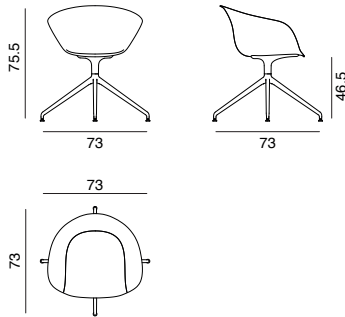

Armchair with polished or powdercoated aluminium swivel trestle base. Polypropylene shell available in 4 colors, with front upholstery in leather, coated fabric, fabric or customer's own material.

Accessories:  
Set of glides Art. 2015

SEK ART. 4216	A	B COM	C COL	D	E	F	G	H	I	J	K	L	M	ES
POLISHED / POWDERCOATED	7026	7395	7764	8133	8502	8871	9240	9609	9978	10347	10716	11085	11454	12741

SHIPMENT DETAILS	TECHNICAL SPECIFICATIONS	RESISTANCE TEST
<b>Art.4216</b> 1 pz = 2  - kg 15,28/ m³ 0,367 4 pz = 2  - kg 46,2/ m³ 0,548 	<b>Art.4216</b> COL requirement m² 1.44 H 140 cm. COM Meterage m 1.05	<ul style="list-style-type: none"> <li>• EN 1728:2012 - EN 16139:2013 6.10</li> <li>• EN 1728:2012 - EN 16139:2013 6.15</li> <li>• EN 1728:2012 - EN 16139:2013 6.17</li> <li>• EN 1728:2012 - EN 16139:2013 6.20</li> <li>• EN 1728:2012 - EN 16139:2013 6.25</li> <li>• EN 1728:2012 - EN 16139:2013 6.4</li> </ul> <ul style="list-style-type: none"> <li>• EN 1728:2012 - EN 16139:2013 6.11</li> <li>• EN 1728:2012 - EN 16139:2013 6.16</li> <li>• EN 1728:2012 - EN 16139:2013 6.18</li> <li>• EN 1728:2012 - EN 16139:2013 6.24</li> <li>• EN 1728:2012 - EN 16139:2013 6.26</li> <li>• EN 1728:2012 - EN 16139:2013 6.5</li> </ul>

**FIRE RETARDANT TEST**  
 Classe 1IM Omologazione Italia Field Kvadrat. Remix 3 Kvadrat. Steelcut Trio 3 Kvadrat. Coated fabric Valencia Spradling.

## Frame Base



## Shell



# Duna 02

Design by Lievore Altherr Molina, 2014

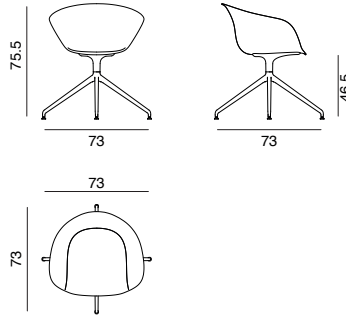

Armchair with polished or powder-coated aluminium swivel trestle base. Shell fully upholstered in leather, coated fabric, fabric or customer's own material.

Accessories:  
Set of glides Art. 2015

SEK ART. 4236	A	B COM	C COL	D	E	F	G	H	I	J	K	L	M	ES
POLISHED / POWDERCOATED	7180	7680	8180	8680	9180	9680	10180	10680	11180	11680	12180	12680	13180	15051
<b>SHIPMENT DETAILS</b>		<b>TECHNICAL SPECIFICATIONS</b>				<b>RESISTANCE TEST</b>								
<b>Art.4236</b> 1 pz = 2  - kg 15,28/ m³ 0,367 4 pz = 2  - kg 39,2/ m³ 0,548 		<b>Art.4236</b> COL requirement m² 2.66 H 140 cm. COM Meterage m 1.72				<ul style="list-style-type: none"> <li>• EN 1728:2012 - EN 16139:2013 6.10</li> <li>• EN 1728:2012 - EN 16139:2013 6.15</li> <li>• EN 1728:2012 - EN 16139:2013 6.17</li> <li>• EN 1728:2012 - EN 16139:2013 6.20</li> <li>• EN 1728:2012 - EN 16139:2013 6.25</li> <li>• EN 1728:2012 - EN 16139:2013 6.4</li> </ul>				<ul style="list-style-type: none"> <li>• EN 1728:2012 - EN 16139:2013 6.11</li> <li>• EN 1728:2012 - EN 16139:2013 6.16</li> <li>• EN 1728:2012 - EN 16139:2013 6.18</li> <li>• EN 1728:2012 - EN 16139:2013 6.24</li> <li>• EN 1728:2012 - EN 16139:2013 6.26</li> <li>• EN 1728:2012 - EN 16139:2013 6.5</li> </ul>				
<b>FIRE RETARDANT TEST</b>														

Frame Base



# Duna 02

Design by Lievore Altherr Molina, 2014

Armchair with polished or powdercoated aluminium fixed trestle base, mounted on selfbraking castors. Polypropylene shell available in 4 colors.

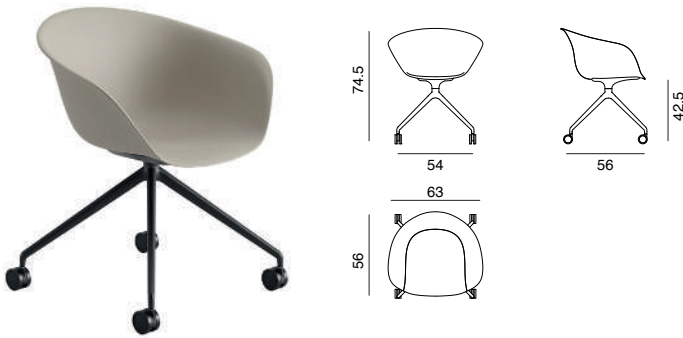

<b>SEK ART. 4207</b>	PP	
POLISHED / POWDERCOATED	5025	
Polypropylene fire retardant	+ 441	(For all finishes qty min. 300 pcs)
<b>SHIPMENT DETAILS</b>	<b>TECHNICAL SPECIFICATIONS</b>	<b>RESISTANCE TEST</b>
<b>Art.4207</b> 1 pz = 2  - kg 15,38/ m³ 0,367 4 pz = 2  - kg 46,6/ m³ 0,552 	<b>Art.4207</b> *Classe 1, 2, 11M: fire retardant version available with surcharge and eventual minimum batch	<ul style="list-style-type: none"> <li>• EN 1728:2012 - EN 16139:2013 6.10</li> <li>• EN 1728:2012 - EN 16139:2013 6.17</li> <li>• EN 1728:2012 - EN 16139:2013 6.20</li> <li>• EN 1728:2012 - EN 16139:2013 6.25</li> <li>• EN 1728:2012 - EN 16139:2013 6.4</li> </ul> <ul style="list-style-type: none"> <li>• EN 1728:2012 - EN 16139:2013 6.11</li> <li>• EN 1728:2012 - EN 16139:2013 6.18</li> <li>• EN 1728:2012 - EN 16139:2013 6.24</li> <li>• EN 1728:2012 - EN 16139:2013 6.26</li> <li>• EN 1728:2012 - EN 16139:2013 6.5</li> </ul>
<b>FIRE RETARDANT TEST</b>		
* FIRE RETARDANT VERSION WITH SURCHARGE * Classe 2 Omologazione Italia Polipropilene.		

## Frame Base



## Shell



# Duna 02

Design by Lievore Altherr Molina, 2014

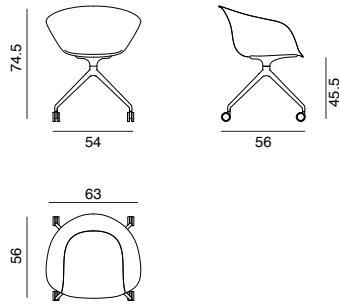

Armchair with polished or powdercoated aluminium fixed trestle base, mounted on selfbraking castors. Polypropylene shell available in 4 colors, with seat cushion in leather, coated fabric, fabric or customer's own material.

SEK ART. 4227	A	B COM	C COL	D	E	F	G	H	I	J	K	L	M	ES
POLISHED / POWDERCOATED	5882	6025	6168	6311	6454	6597	6740	6883	7026	7169	7312	7455	7598	8275
<b>SHIPMENT DETAILS</b>		<b>TECHNICAL SPECIFICATIONS</b>				<b>RESISTANCE TEST</b>								
<b>Art.4227</b> 1 pz = 2  - kg 15,38/ m³ 0,367 4 pz = 2  - kg 46,6/ m³ 0,552 		<b>Art.4227</b> COL requirement m² 0.56 H 140 cm. COM Meterage m 0.7				<ul style="list-style-type: none"> <li>• EN 1728:2012 - EN 16139:2013 6.10</li> <li>• EN 1728:2012 - EN 16139:2013 6.17</li> <li>• EN 1728:2012 - EN 16139:2013 6.20</li> <li>• EN 1728:2012 - EN 16139:2013 6.25</li> <li>• EN 1728:2012 - EN 16139:2013 6.4</li> </ul>				<ul style="list-style-type: none"> <li>• EN 1728:2012 - EN 16139:2013 6.11</li> <li>• EN 1728:2012 - EN 16139:2013 6.18</li> <li>• EN 1728:2012 - EN 16139:2013 6.24</li> <li>• EN 1728:2012 - EN 16139:2013 6.26</li> <li>• EN 1728:2012 - EN 16139:2013 6.5</li> </ul>				
<b>FIRE RETARDANT TEST</b>														
Classe 1IM Omologazione Italia Field Kvadrat. Remix 3 Kvadrat. Steelcut 2 Kvadrat. Steelcut Trio 3 Kvadrat. Coated fabric Valencia Spradling.														

## Frame Base



## Shell



# Duna 02

Design by Lievore Altherr Molina, 2014

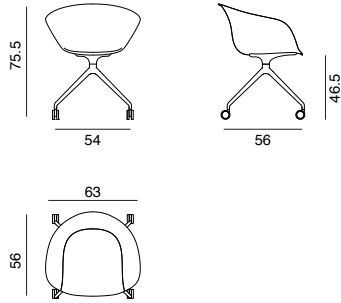

Armchair with polished or powdercoated aluminium fixed trestle base, mounted on selfbraking castors. Polypropylene shell available in 4 colors, with front upholstery in leather, coated fabric, fabric or customer's own material.

SEK ART. 4217	A	B COM	C COL	D	E	F	G	H	I	J	K	L	M	ES
POLISHED / POWDERCOATED	7562	7931	8300	8669	9038	9407	9776	10145	10514	10883	11252	11621	11990	13277
<b>SHIPMENT DETAILS</b>		<b>TECHNICAL SPECIFICATIONS</b>				<b>RESISTANCE TEST</b>								
<b>Art.4217</b> 1 pz = 2  - kg 15,38/ m³ 0,367 4 pz = 2  - kg 46,6/ m³ 0,552 		<b>Art.4217</b> COL requirement m² 1.44 H 140 cm. COM Meterage m 1.05				<ul style="list-style-type: none"> <li>• EN 1728:2012 - EN 16139:2013 6.10</li> <li>• EN 1728:2012 - EN 16139:2013 6.17</li> <li>• EN 1728:2012 - EN 16139:2013 6.20</li> <li>• EN 1728:2012 - EN 16139:2013 6.25</li> <li>• EN 1728:2012 - EN 16139:2013 6.4</li> </ul>				<ul style="list-style-type: none"> <li>• EN 1728:2012 - EN 16139:2013 6.11</li> <li>• EN 1728:2012 - EN 16139:2013 6.18</li> <li>• EN 1728:2012 - EN 16139:2013 6.24</li> <li>• EN 1728:2012 - EN 16139:2013 6.26</li> <li>• EN 1728:2012 - EN 16139:2013 6.5</li> </ul>				
<b>FIRE RETARDANT TEST</b>														
Classe 1IM Omologazione Italia Field Kvadrat. Remix 3 Kvadrat. Steelcut Trio 3 Kvadrat. Coated fabric Valencia Spradling.														

## Frame Base



## Shell



# Duna 02

Design by Lievore Altherr Molina, 2014

Armchair with polished or powder-coated aluminium fixed trestle base, mounted on selfbraking castors. Shell fully upholstered in leather, coated fabric, fabric or customer's own material.

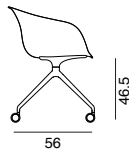
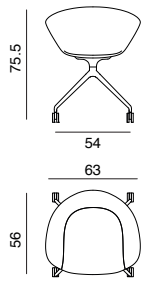

SEK ART. 4237	A	B COM	C COL	D	E	F	G	H	I	J	K	L	M	ES
POLISHED / POWDERCOATED	7716	8216	8716	9216	9716	10216	10716	11216	11716	12216	12716	13216	13716	15587
<b>SHIPMENT DETAILS</b>		<b>TECHNICAL SPECIFICATIONS</b>				<b>RESISTANCE TEST</b>								
<b>Art.4237</b> 1 pz = 2  - kg 15,38/ m³ 0,367 4 pz = 2  - kg 39,2/ m³ 0,552 		<b>Art.4237</b> COL requirement m² 2.66 H 140 cm. COM Meterage m 1.72				<ul style="list-style-type: none"> <li>• EN 1728:2012 - EN 16139:2013 6.10</li> <li>• EN 1728:2012 - EN 16139:2013 6.17</li> <li>• EN 1728:2012 - EN 16139:2013 6.20</li> <li>• EN 1728:2012 - EN 16139:2013 6.25</li> <li>• EN 1728:2012 - EN 16139:2013 6.4</li> </ul>			<ul style="list-style-type: none"> <li>• EN 1728:2012 - EN 16139:2013 6.11</li> <li>• EN 1728:2012 - EN 16139:2013 6.18</li> <li>• EN 1728:2012 - EN 16139:2013 6.24</li> <li>• EN 1728:2012 - EN 16139:2013 6.26</li> <li>• EN 1728:2012 - EN 16139:2013 6.5</li> </ul>					
<b>FIRE RETARDANT TEST</b>														

Frame Base



# Duna 02

Design by Lievore Altherr Molina, 2014

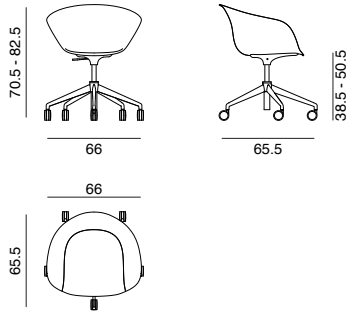

Chair with polished or powdercoated aluminium five-star base, mounted on self braking castors and fitted with gas mechanism. Polypropylene shell available in 4 colors.

<b>SEK ART. 4209</b>	PP	
GAS MECHANISM	6168	
Polypropylene fire retardant	+ 441	(For all finishes qty min. 300 pcs)
<b>SHIPMENT DETAILS</b>	<b>TECHNICAL SPECIFICATIONS</b>	<b>RESISTANCE TEST</b>
<b>Art.4209</b> 1 pz = 2  - kg 19,08/ m³ 0,41 4 pz = 5  - kg 68,6/ m³ 1,14 	<b>Art.4209</b> *Classe 1, 2, 11M: fire retardant version available with surcharge and eventual minimum batch	<ul style="list-style-type: none"> <li>• EN 1728:2012 - EN 16139:2013 6.10</li> <li>• EN 1728:2012 - EN 16139:2013 6.17</li> <li>• EN 1728:2012 - EN 16139:2013 6.20</li> <li>• EN 1728:2012 - EN 16139:2013 6.26</li> <li>• EN 1728:2012 - EN 16139:2013 6.5</li> </ul> <ul style="list-style-type: none"> <li>• EN 1728:2012 - EN 16139:2013 6.11</li> <li>• EN 1728:2012 - EN 16139:2013 6.18</li> <li>• EN 1728:2012 - EN 16139:2013 6.25</li> <li>• EN 1728:2012 - EN 16139:2013 6.4</li> </ul>
<b>FIRE RETARDANT TEST</b>		
* FIRE RETARDANT VERSION WITH SURCHARGE * Classe 2 Omologazione Italia Polipropilene.		

## Frame Base

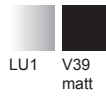

## Shell





# Duna 02

Design by Lievore Altherr Molina, 2014

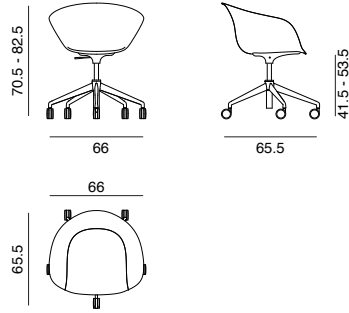

Chair with polished or powdercoated aluminium five-star base, mounted on self braking castors and equipped with gas mechanism. Polypropylene shell available in 4 colors, with seat cushion in leather, coated fabric, fabric or customer's own material.

SEK ART. 4229	A	B COM	C COL	D	E	F	G	H	I	J	K	L	M	ES
GAS MECHANISM	7025	7168	7311	7454	7597	7740	7883	8026	8169	8312	8455	8598	8741	9418
<b>SHIPMENT DETAILS</b>		<b>TECHNICAL SPECIFICATIONS</b>				<b>RESISTANCE TEST</b>								
<b>Art.4229</b> 1 pz = 2  - kg 19,08/ m³ 0,41 4 pz = 5  - kg 68,6/ m³ 1,14 KD		<b>Art.4229</b> COL requirement m² 0.56 H 140 cm. COM Meterage m 0.7				<ul style="list-style-type: none"> <li>EN 1728:2012 - EN 16139:2013 6.10</li> <li>EN 1728:2012 - EN 16139:2013 6.17</li> <li>EN 1728:2012 - EN 16139:2013 6.20</li> <li>EN 1728:2012 - EN 16139:2013 6.26</li> <li>EN 1728:2012 - EN 16139:2013 6.5</li> </ul>				<ul style="list-style-type: none"> <li>EN 1728:2012 - EN 16139:2013 6.11</li> <li>EN 1728:2012 - EN 16139:2013 6.18</li> <li>EN 1728:2012 - EN 16139:2013 6.25</li> <li>EN 1728:2012 - EN 16139:2013 6.4</li> </ul>				
<b>FIRE RETARDANT TEST</b>														
Classe 1IM Omologazione Italia Field Kvadrat. Remix 3 Kvadrat. Steelcut 2 Kvadrat. Steelcut Trio 3 Kvadrat. Coated fabric Valencia Spradling.														

## Frame Base

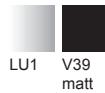

LU1 V39  
matt



## Shell



PP0001 PP0004 PP0005 PP0006



# Duna 02

Design by Lievore Altherr Molina, 2014

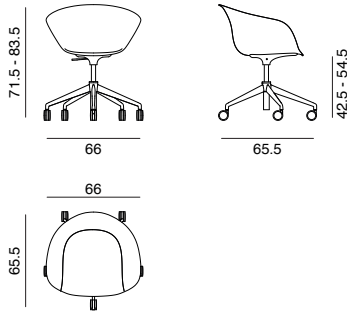

Chair with polished or powdercoated aluminium five-star base, mounted on self braking castors and equipped with gas mechanism. Polypropylene shell available in 4 colors, with front upholstery in leather, coated fabric, fabric or customer's own material.

SEK ART. 4219	A	B COM	C COL	D	E	F	G	H	I	J	K	L	M	ES
GAS MECHANISM	8705	9074	9443	9812	10181	10550	10919	11288	11657	12026	12395	12764	13133	14420
<b>SHIPMENT DETAILS</b>		<b>TECHNICAL SPECIFICATIONS</b>				<b>RESISTANCE TEST</b>								
<b>Art.4219</b> 1 pz = 2  - kg 19,08/ m³ 0,41 4 pz = 5  - kg 68,6/ m³ 1,14 		<b>Art.4219</b> COL requirement m² 1.44 H 140 cm. COM Meterage m 1.05				<ul style="list-style-type: none"> <li>• EN 1728:2012 - EN 16139:2013 6.10</li> <li>• EN 1728:2012 - EN 16139:2013 6.17</li> <li>• EN 1728:2012 - EN 16139:2013 6.20</li> <li>• EN 1728:2012 - EN 16139:2013 6.26</li> <li>• EN 1728:2012 - EN 16139:2013 6.5</li> </ul>				<ul style="list-style-type: none"> <li>• EN 1728:2012 - EN 16139:2013 6.11</li> <li>• EN 1728:2012 - EN 16139:2013 6.18</li> <li>• EN 1728:2012 - EN 16139:2013 6.25</li> <li>• EN 1728:2012 - EN 16139:2013 6.4</li> </ul>				
<b>FIRE RETARDANT TEST</b>														
Classe 1IM Omologazione Italia Field Kvadrat. Remix 3 Kvadrat. Steelcut Trio 3 Kvadrat. Coated fabric Valencia Spradling.														

## Frame Base

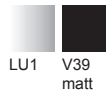

LU1 V39  
matt



## Shell



PP0001 PP0004 PP0005 PP0006



# Duna 02

Design by Lievore Altherr Molina, 2014

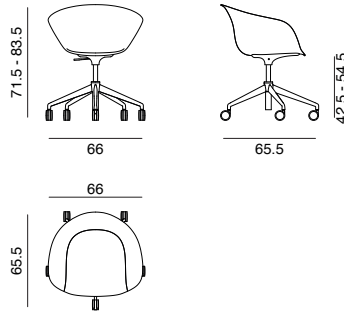

Chair with polished or powder-coated aluminium five-star base, mounted on self braking castors and equipped with gas mechanism. Shell fully upholstered in leather, coated fabric, fabric or customer's own material.

SEK ART. 4239	A	B COM	C COL	D	E	F	G	H	I	J	K	L	M	ES
GAS MECHANISM	8859	9359	9859	10359	10859	11359	11859	12359	12859	13359	13859	14359	14859	16730
<b>SHIPMENT DETAILS</b>		<b>TECHNICAL SPECIFICATIONS</b>				<b>RESISTANCE TEST</b>								
<b>Art.4239</b> 1 pz = 2  - kg 19,08/ m³ 0,41 4 pz = 5  - kg 61,6/ m³ 1,14 		<b>Art.4239</b> COL requirement m² 2.66 H 140 cm. COM Meterage m 1.72				<ul style="list-style-type: none"> <li>• EN 1728:2012 - EN 16139:2013 6.10</li> <li>• EN 1728:2012 - EN 16139:2013 6.17</li> <li>• EN 1728:2012 - EN 16139:2013 6.20</li> <li>• EN 1728:2012 - EN 16139:2013 6.26</li> <li>• EN 1728:2012 - EN 16139:2013 6.5</li> </ul>				<ul style="list-style-type: none"> <li>• EN 1728:2012 - EN 16139:2013 6.11</li> <li>• EN 1728:2012 - EN 16139:2013 6.18</li> <li>• EN 1728:2012 - EN 16139:2013 6.25</li> <li>• EN 1728:2012 - EN 16139:2013 6.4</li> </ul>				
<b>FIRE RETARDANT TEST</b>														

Frame Base

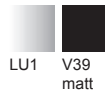

# Accessories



Design by Lievore Altherr Molina

## SEK ART. 2015



Set of glides (white or black) in felt

202

SHIPMENT DETAILS	TECHNICAL SPECIFICATIONS	RESISTANCE TEST
<b>Art. 2015</b> 1 pz = 1  - kg 0,08/ m <sup>3</sup> 0,001 10 pz = 1  - kg 1,2/ m <sup>3</sup> 0,007		
<b>FIRE RETARDANT TEST</b>		





# JUNO 02

Design by James Irvine

2012 — New Edition 2022



## Collection overview

---

### Type



4 legs



4 legs with armrests

---

### Versions



Polypropylene



Polypropylene  
with seat cushion

---



Outdoor version:  
Only polypropylene

Juno 02 is an evolution of the previous model.  
Structural tests and product certifications are in progress.  
Contact us for more information.

# Juno 02

Design by James Irvine, 2022

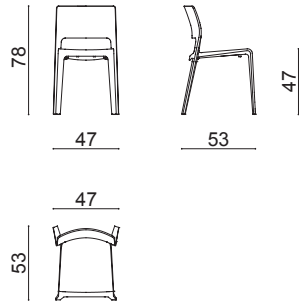

Four-leg polypropylene chair, made in 70% recycled material, available in 6 different colours. Provided with glides suitable for different surfaces. Minimum order: 2 items with the same finish.

Accessories:  
Single trolley Art. 0500  
Link Art. 3618

Stackability:  
(should the weight exceed 25 kilos a handling tool must be used).  
– without trolley up to 10 units  
– with trolley up to 15 units

<b>SEK ART. 3620</b>	<b>PT</b>	
	1668	

SHIPMENT DETAILS	TECHNICAL SPECIFICATIONS	RESISTANCE TEST
<b>Art.3620</b> 1 pz = 1  - kg 7,228/ m³ 0,27 2 pz = 1  - kg 11,356/ m³ 0,27 4 pz = 1  - kg 20,072/ m³ 0,338 6 pz = 1  - kg 28,788/ m³ 0,4	<b>Art.3620</b> Juno 02 is an evolution of the previous model. Structural tests and product certifications are in progress. Contact us for more information.	<ul style="list-style-type: none"> <li>• EN 1728:2012 - EN 16139:2013 6.15</li> <li>• EN 1728:2012 - EN 16139:2013 6.17</li> <li>• EN 1728:2012 - EN 16139:2013 6.24</li> <li>• EN 1728:2012 - EN 16139:2013 4.1-4.2</li> <li>• EN 1728:2012 - EN 16139:2013 6.5</li> <li>• ANSI/BIFMA X5.1-2017/6</li> <li>• ANSI/BIFMA X5.1-2017/10</li> <li>• ANSI/BIFMA X5.1-2017/15</li> <li>• ANSI/BIFMA X5.1-2017/24</li> <li>• EN 1022:2018 7.3</li> </ul>
<b>FIRE RETARDANT TEST</b>		



Polypropylene

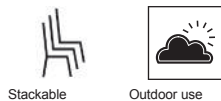



# Juno 02

Design by James Irvine, 2022

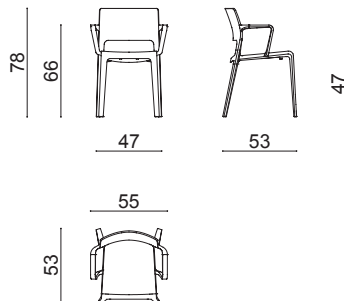

Four-leg polypropylene chair with armrests, made in 70% recycled material, available in 6 different colours. Provided with glides suitable for different surfaces. Minimum order: 2 items with the same finish.

Accessories:  
Single trolley Art. 0500  
Link Art. 3618

Stackability:  
(should the weight exceed 25 kilos a handling tool must be used).  
– without tools up to 5 units  
– with trolley up to 5 units

<b>SEK ART. 3621</b>	PT	
	2083	

SHIPMENT DETAILS	TECHNICAL SPECIFICATIONS	RESISTANCE TEST
<b>Art.3621</b> 1 pz = 1  - kg 7,97/ m³ 0,262 2 pz = 1  - kg 12,4/ m³ 0,312 4 pz = 1  - kg 21,66/ m³ 0,406	<b>Art.3621</b> Juno 02 is an evolution of the previous model. Structural tests and product certifications are in progress. Contact us for more information.	<ul style="list-style-type: none"> <li>• EN 1728:2012 - EN 16139:2013 6.10</li> <li>• EN 1728:2012 - EN 16139:2013 6.17</li> <li>• EN 1728:2012 - EN 16139:2013 6.20</li> <li>• EN 1728:2012 - EN 16139:2013 6.5</li> <li>• ANSI/BIFMA X5.1-2017/6</li> <li>• ANSI/BIFMA X5.1-2017/10</li> <li>• ANSI/BIFMA X5.1-2017/12</li> <li>• ANSI/BIFMA X5.1-2017/15</li> <li>• ANSI/BIFMA X5.1-2017/24</li> </ul>
<b>FIRE RETARDANT TEST</b>		

Polypropylene

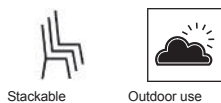

# Juno 02

Design by James Irvine, 2022

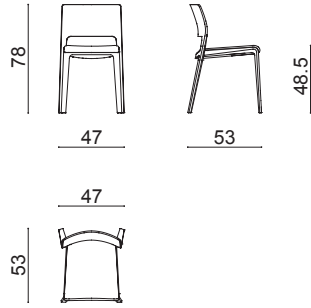

Four-leg polypropylene chair with seat cushion. Made in 70% recycled material, available in 6 different colours. The cushion is available in fabric, leather, coated fabric or customer's material. Stacking protections included. Provided with glides suitable for different surfaces. Minimum order: 2 items with the same finish.

Accessories:  
Single trolley Art. 0500  
Link Art. 3618

Stackability:  
(should the weight exceed 25 kilos a handling tool must be used).  
– without tools up to 10 units  
– with trolley up to 10 units

SEK ART. 3622	A	B COM	C COL	D	E	F	G	H	I	J	K	L	M	ES
	2786	2869	2952	3035	3118	3201	3284	3367	3450	3533	3616	3699	3782	4180

SHIPMENT DETAILS	TECHNICAL SPECIFICATIONS	RESISTANCE TEST
<b>Art.3622</b> 1 pz = 1  - kg 8,174/ m³ 0,262 2 pz = 2  - kg 12,236/ m³ 0,27 4 pz = 1  - kg 25,16/ m³ 0,338 6 pz = 1  - kg 36,42/ m³ 0,4	<b>Art.3622</b> COL requirement m² 0.48 H 140 cm. COM Meterage m 064 Juno 02 is an evolution of the previous model. Structural tests and product certifications are in progress. Contact us for more information.	
<b>FIRE RETARDANT TEST</b>		

Polypropylene



# Juno 02

Design by James Irvine, 2022

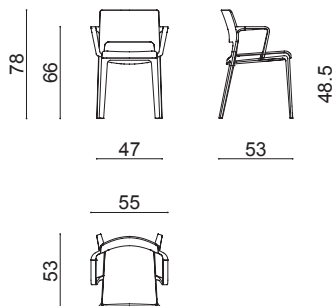

Four-leg polypropylene chair with armrests and seat cushion. Made in 70% recycled material, available in 6 different colours. The cushion is available in fabric, leather, coated fabric or customer's material. Stacking protections included. Provided with glides suitable for different surfaces. Minimum order: 2 items with the same finish.

Accessories:  
Single trolley Art. 0500  
Link Art. 3618

Stackability:  
(should the weight exceed 25 kilos a handling tool must be used).  
– without tools up to 5 units  
– with trolley up to 5 units

SEK ART. 3623	A	B COM	C COL	D	E	F	G	H	I	J	K	L	M	ES
	3215	3298	3381	3464	3547	3630	3713	3796	3879	3962	4045	4128	4211	4596



SHIPMENT DETAILS	TECHNICAL SPECIFICATIONS	RESISTANCE TEST
<b>Art.3623</b> 1 pz = 1  - kg 9,242/ m³ 0,262 2 pz = 1  - kg 13,084/ m³ 0,312 4 pz = 1  - kg 26,748/ m³ 0,406	<b>Art.3623</b> COL requirement m² 0.48 H 140 cm. COM Meterage m 0.64 Juno 02 is an evolution of the previous model. Structural tests and product certifications are in progress. Contact us for more information.	
<b>FIRE RETARDANT TEST</b>		





Polypropylene



# Accessories

Design by James Irvine

<p><b>SEK ART. 0500</b></p>  <p>Trolley (Aava 02, Catifa 46, Catifa 53, Juno 02, Mixu)</p> <p>4549</p>	<p><b>SEK ART. 3618</b></p>  <p>Link</p> <p>143</p>
---	--

SHIPMENT DETAILS	TECHNICAL SPECIFICATIONS	RESISTANCE TEST
<p><b>Art. 3618</b></p> <p>1 pz = 0  - kg 1,5/ m³ 0,012</p> <p>1 pz = 1  - kg 1,5/ m³ 0,012</p> <p>10 pz = 1  - kg 1,5/ m³ 0,012</p> <p>2 pz = 1  - kg 1,5/ m³ 0,012</p> <p>4 pz = 1  - kg 1,5/ m³ 0,012</p>		
<p><b>FIRE RETARDANT TEST</b></p>		





# KATA

---

Design by  
Altherr Désile Park  
2021



# Kata

## Collection overview

---

### Bases



Solid oak frame

Solid black locust frame

---

### Types of Upholstery



Micro-padded 3D Knit with graphic pattern



3D Knit with striped pattern

---

### Options



Set of seat and lumbar cushions  
Micro-padded 3D Knit with graphic pattern



Set of seat and lumbar cushions  
Fabric, leather, coated fabric

---

### Outdoor options

- Solid black locust frame
- 3D Knit with striped pattern
- Set of seat and lumbar cushions in outdoor fabrics



Outdoor

# Kata

## New Fabrics

The Kata lounge chair is a union of traditional craftsmanship and soft technology. An oak and black locust FSC certified wooden frame supports a tailor-made 3D knit textile. The knit cover is created from recycled polyester made from post-consumer plastic that is converted into durable, lightweight fibers suitable for indoor or outdoor use. The knit technology is formed to fit the frame, avoiding leftover material waste found in traditional manufacturing.

The unified seat and back structure is available in a textured knit with internal micro-padding in natural tones of linen, wheat, or charcoal, or a lightweight 3D knit in parallel striped pattern in a choice of colors: water, wheat, or charcoal.

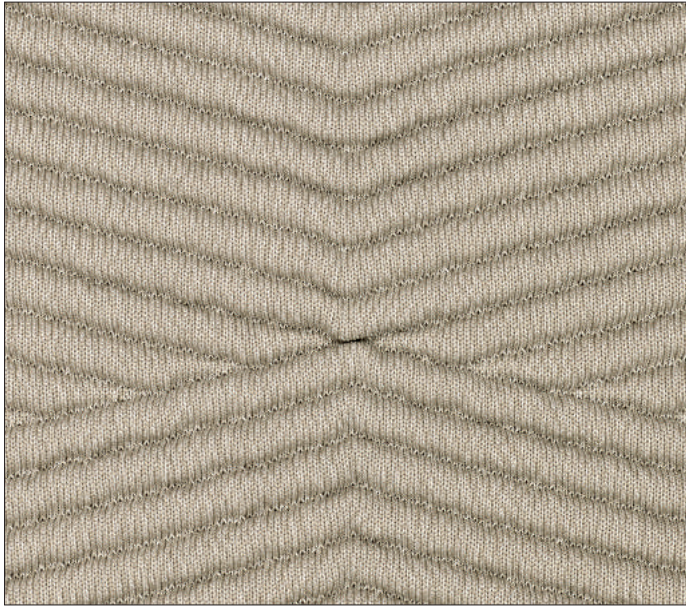

**3D Knit — Altherr, Désile, Park**  
3 colors  
Micro-padded 3D Knit with graphic pattern

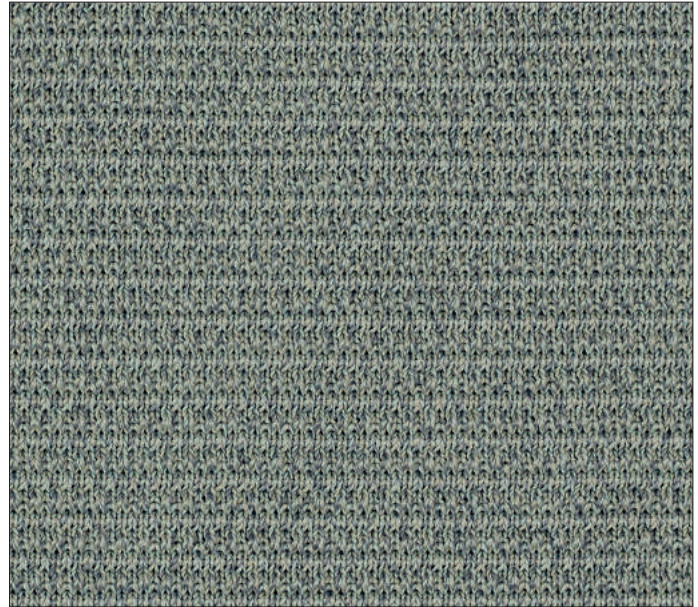

**3D Knit — Altherr, Désile, Park**  
3 colors  
3D Knit with striped pattern



# Kata

Design by Altherr Désile Park, 2021

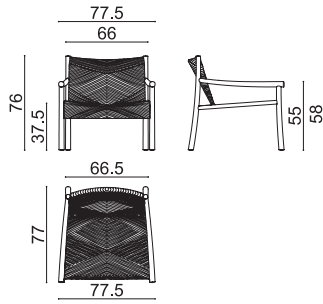

Lounge armchair with solid oak frame in natural or black stained finish. Shell with steel frame and micro-padded 3D Knit fabric with graphic pattern made with recycled polyester fibre yarns and available in 3 colours. Suitable for indoor use.

Accessories:  
3D Knit cushions with graphic pattern Art. 5604

<b>SEK ART. 5600</b>	3D Knit	
OAK	17956	

SHIPMENT DETAILS	TECHNICAL SPECIFICATIONS	RESISTANCE TEST
<b>Art.5600</b> 1 pz = 1  - kg 14/ m <sup>2</sup> 0,55		<ul style="list-style-type: none"> <li>• EN 1728:2012 - EN 16139:2013 6.10</li> <li>• EN 1728:2012 - EN 16139:2013 6.15</li> <li>• EN 1728:2012 - EN 16139:2013 6.20</li> <li>• EN 1728:2012 - EN 16139:2013 6.25</li> <li>• EN 1728:2012 - EN 16139:2013 4.1-4.2</li> <li>• EN 1728:2012 - EN 16139:2013 6.5</li> <li>• EN 1728:2012 - EN 16139:2013 6.18</li> </ul>
		<ul style="list-style-type: none"> <li>• EN 1728:2012 - EN 16139:2013 6.11</li> <li>• EN 1728:2012 - EN 16139:2013 6.16</li> <li>• EN 1728:2012 - EN 16139:2013 6.24</li> <li>• EN 1728:2012 - EN 16139:2013 6.26</li> <li>• EN 1728:2012 - EN 16139:2013 6.4</li> <li>• EN 1728:2012 - EN 16139:2013 6.17</li> <li>• EN 1022:2018 7.3</li> </ul>
<b>FIRE RETARDANT TEST</b>		

Frame Base



# Kata

Design by Altherr Désile Park, 2021

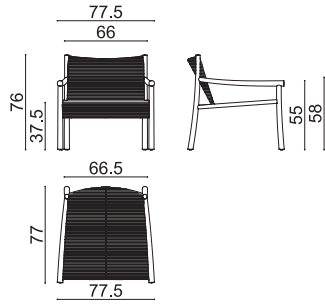

Lounge armchair with solid oak frame in natural or black stained finish. Shell with steel frame and 3D Knit fabric with striped pattern made with recycled polyester fibre yarns and available in 3 colours. Suitable for indoor use.

Accessories:  
Indoor cushions Art. 5605

<b>SEK ART. 5601</b>	3D Knit	
OAK	16098	

SHIPMENT DETAILS	TECHNICAL SPECIFICATIONS	RESISTANCE TEST
<b>Art. 5601</b> 1 pz = 1  - kg 14/ m² 0,55		
<b>FIRE RETARDANT TEST</b>		

Frame Base

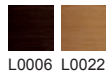

# Kata

Design by Altherr Désile Park, 2021

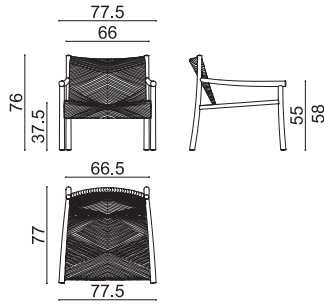

Lounge armchair with solid black locust frame with teak stained finish. Shell with steel frame and micro-padded 3D Knit fabric with graphic pattern made with recycled polyester fibre yarns and available in 3 colours. Suitable for indoor use.

Accessories:  
3D Knit cushions with graphic pattern Art. 5604

<b>SEK ART. 5602</b>	3D Knit	
BLACK LOCUST	19814	

SHIPMENT DETAILS	TECHNICAL SPECIFICATIONS	RESISTANCE TEST
<b>Art.5602</b> 1 pz = 1  - kg 14/ m³ 0,55		
<b>FIRE RETARDANT TEST</b>		

Frame Base



L0023



# Kata

Design by Altherr Désile Park, 2021

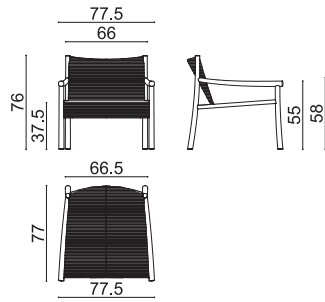

Lounge armchair with solid black locust frame with teak stained finish. Shell with steel frame and 3D Knit fabric with striped pattern made with recycled polyester fibre yarns and available in 3 colours. Suitable for indoor and outdoor use.

Accessories:  
 Indoor cushions Art. 5605  
 Outdoor cushions Art. 5606  
 Protective slipcover Art. 5607

<b>SEK ART. 5603</b>	3D Knit	
BLACK LOCUST	17956	

SHIPMENT DETAILS	TECHNICAL SPECIFICATIONS	RESISTANCE TEST
<b>Art. 5603</b> 1 pz = 1  - kg 14/ m² 0,55		<ul style="list-style-type: none"> <li>• EN 1728:2012 - EN 16139:2013 6.10</li> <li>• EN 1728:2012 - EN 16139:2013 6.15</li> <li>• EN 1728:2012 - EN 16139:2013 6.20</li> <li>• EN 1728:2012 - EN 16139:2013 6.25</li> <li>• EN 1728:2012 - EN 16139:2013 4.1-4.2</li> <li>• EN 1728:2012 - EN 16139:2013 6.5</li> <li>• EN 1728:2012 - EN 16139:2013 6.18</li> <li>• EN 1022:2018</li> </ul>
<b>FIRE RETARDANT TEST</b>		

Frame Base



L0023



Outdoor use

# Kata

Design by Altherr Désile Park, 2021

Set composed of seat cushion and lumbar cushion upholstered with micro-padded 3D Knit fabric with graphic pattern made with recycled polyester fibre yarns and available in 3 colours. The accessory, which can be combined with the armchairs in micro-padded 3D Knit with a graphic pattern, is removable and suitable for indoor use.

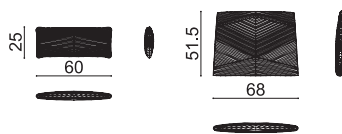

<b>SEK ART. 5604</b>	3D Knit	
SET OF CUSHIONS – GRAPHIC PATTERN	3096	

SHIPMENT DETAILS	TECHNICAL SPECIFICATIONS	RESISTANCE TEST
<b>Art.5604</b> 1 pz = 1  - kg 5/ m³ 0,07		
<b>FIRE RETARDANT TEST</b>		



# Kata

Design by Altherr Désile Park, 2021

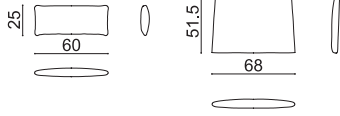

Set composed of seat cushion and lumbar cushion upholstered with fabric, leather, coated fabric or customer's own material. On request and with an additional charge, the two cushions that form the set can be made using different shades of the same cover. The accessory – which can be combined with the armchairs in 3D Knit with a striped pattern – is removable and available in both indoor and outdoor versions.

SEK ART. 5605	A	B COM	C COL	D	E	F	G	H	I	J	K	L	M	ES
SET OF CUSHIONS – INDOOR	2476	2822	3168	3514	3860	4206	4552	4898	5244	5590	5936	6282	6628	8025
Upholstery: two colors	166	285	404	523	642	761	880	999	1118	1237	1356	1475	1594	2144
SEK ART. 5606	COM	Heritage Savane Silvertex	Patio											
SET OF CUSHIONS — OUTDOOR	2859	3098	3337											
Rivestimento: 2 colori	285	404	523											

SHIPMENT DETAILS	TECHNICAL SPECIFICATIONS	RESISTANCE TEST
<b>Art. 5605</b> 1 pz = 1  - kg 5/ m³ 0,07 <b>Art. 5606</b> 1 pz = 1  - kg 5/ m³ 0,07	<b>Art. 5605</b> COL requirement m² 3 H 140 cm. COM Meterage m 1.02 <b>Art. 5606</b> H 140 cm. COM Meterage m 1.02	
FIRE RETARDANT TEST		



Outdoor use

# Kata

Design by Altherr Désile Park, 2021

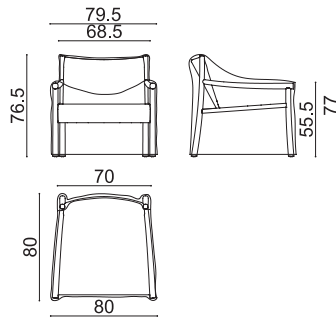

Protective slipcover for outdoor use made of waterproof fabric with lower fastening lace.

<b>SEK ART. 5607</b>	-	
PROTECTIVE SLIPCOVER	2727	

SHIPMENT DETAILS	TECHNICAL SPECIFICATIONS	RESISTANCE TEST
<b>Art.5607</b> 1 pz = 1  - kg 1/ m³ 0,1		
<b>FIRE RETARDANT TEST</b>		



Outdoor use

# KINESIT

---

Design by  
Lievore Altherr Molina  
2014





# Kinesit

## Collection overview

---

### Bases



5 ways aluminum and gas mechanism  
Optional armrests



Aluminum trestle swivel  
Optional armrests



Aluminum trestle fixed  
Optional armrests

---

### Backrest



Low



Medium

---

### Upholsteries



Polypropylene backrest, front face mesh and upholstered seat.



Polypropylene backrest with upholstered front face.



Entirely upholstered seat and backrest.

---

---

## Options

### Armrest types



Armrest fixed



Adjustable in 2D

---

## Mechanism



- 
- Built-in self-tensioning weight response mechanism
  - Backrest with 3-position recline
  - Adjustable lumbar support

# Kinesit Met

## Collection overview

---

### Bases



---

5 ways aluminum and  
gas mechanism  
Optional armrests

### Shells



Low backrest



Medium backrest

### Upholsteries



---

Entirely upholstered seat  
and backrest.

# Kinesit Met

---

## Options

### Armrest types



---

Armrest fixed  
Aluminium

### Mechanism



- 
- Built-in self-tensioning weight response mechanism
  - Backrest with 3-position recline
  - Adjustable lumbar support

# Kinesit Met

## Types of Upholstery

Kinesit Met is a sophisticated evolution of the Kinesit office chair, now available in a refreshed palette. Created as Arper's first regulatory-compliant office chair, Kinesit Met is available with metallic finished armrests and in new, rich and nuanced materials, colors, and textures. For this reason, we suggest the following possible combinations:

## Frame Base



V14 matt



**KVADRAT — Steelcut Trio 3**  
ST00205 + ST00226  
Grade: Chairs G

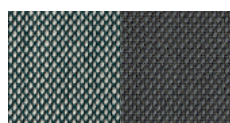

**KVADRAT — Steelcut Trio 3**  
ST00916 + ST00176  
Grade: Chairs G

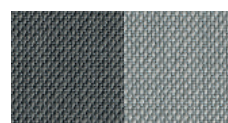

**KVADRAT — Steelcut Trio 3**  
ST00153 + ST00113  
Grade: Chairs G



**KVADRAT — Re-wool**  
RW00828 + RW00218  
Grade: Chairs E



**KVADRAT — Remix 3**  
RX00733 + RX00743  
Grade: Chairs C

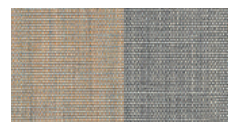

**KVADRAT — Canvas 2**  
CV00224 + CV00124  
Grade: Chairs D

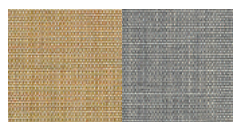

**KVADRAT — Canvas 2**  
CV00414 + CV00124  
Grade: Chairs D



**KVADRAT — Hallingdal 65**  
HA00110 + HA00103  
Grade: Chairs G

# Kinesit Met



V15 matt

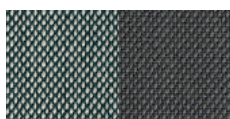

KVADRAT — Steelcut Trio 3  
ST00916 + ST00176  
Grade: Chairs G



KVADRAT — Re-wool  
RW00408 + RW00858  
Grade: Chairs E

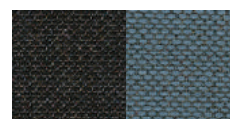

KVADRAT — Re-wool  
RW00198 + RW00768  
Grade: Chairs E



KVADRAT — Remix 3  
RX00196 + RX00266  
Grade: Chairs C



KVADRAT — Remix 3  
RX00973 + RX00996  
Grade: Chairs C



KVADRAT — Remix 3  
RX00286 + RX00163  
Grade: Chairs C

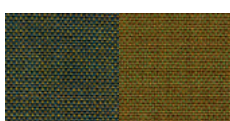

KVADRAT — Remix 3  
RX00842 + RX00412  
Grade: Chairs C

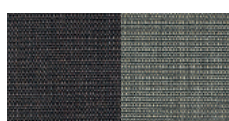

KVADRAT — Canvas 2  
CV00174 + CV00134  
Grade: Chairs D

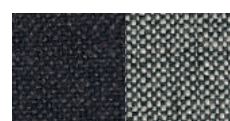

KVADRAT — Hallingdal 65  
HA00180 + HA00126  
Grade: Chairs G

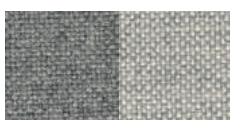

KVADRAT — Hallingdal 65  
HA00130 + HA00110  
Grade: Chairs G



V16 matt

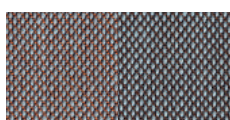

KVADRAT — Steelcut Trio 3  
ST00416 + ST00336  
Grade: Chairs G



KVADRAT — Re-wool  
RW00558 + RW00648  
Grade: Chairs E



KVADRAT — Remix 3  
RX00346 + RX00373  
Grade: Chairs C



KVADRAT — Remix 3  
RX00326 + RX00252  
Grade: Chairs C



KVADRAT — Remix 3  
RX00346 + RX00433  
Grade: Chairs C



KVADRAT — Canvas 2  
CV00374 + CV00674  
Grade: Chairs D



KVADRAT — Canvas 2  
CV00674 + CV00454  
Grade: Chairs D

# Kinesit

Design by Lievore Altherr Molina, 2014



Chair with powder coated aluminum 5 way swivel base on castors (available for hard and soft floors, color matching base), fitted with gas-lift mechanism for height adjustment. Seat with built-in self-tensioning weight response mechanism, backrest with 3-position recline, adjustable lumbar support breathing up to 60 mm. Low backrest with visible backshell (available in black or white), front in polyester mesh in matching color. Seat upholstered in leather, customer's leather, coated fabric, fabric or customer's fabric. Fixed or adjustable armrests in nylon fiber, color matching backshell, are available upon request and with a surcharge.

SEK ART. 4845	A	B COM	C COL	D	E	F	G	H	I	J	K	L	M	ES
POWDERCOATED ALUMINIUM	9644	9846	10048	10250	10452	10654	10856	11058	11260	11462	11664	11866	12068	12848
Armrest 2D	+ 2000													
Armrest	+ 727													

SHIPMENT DETAILS	TECHNICAL SPECIFICATIONS	RESISTANCE TEST
<b>Art.4845</b> 1 pz = 1  - kg 21/ m³ 0,4	<b>Art.4845</b> COL requirement m² 0.85 H 140 cm. COM Meterage m 0.72	
<b>FIRE RETARDANT TEST</b> Classe 11M Omologazione Italia Canvas 2 Kvadrat. Remix 3 Kvadrat. Steelcut Trio 3 Kvadrat. Coated fabric Valencia Spradling.		

Frame Base



Polypropylene



Armrest

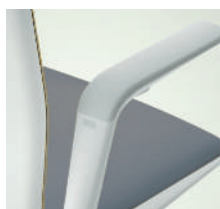

Armrest 2D



Armrest



# Kinesit

Design by Lievore Altherr Molina, 2014

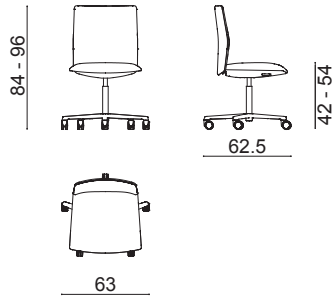

Chair with powder coated aluminum 5 way swivel base on castors (available for hard and soft floors, color matching base), fitted with gas-lift mechanism for height adjustment. Seat with built-in self-tensioning weight response mechanism, backrest with 3-position recline, adjustable lumbar support breathing up to 60 mm. Low backrest with visible backshell (available in black and white) and front back and seat upholstered in leather, customer's leather, coated fabric, fabric or customer's fabric. Fixed or adjustable armrests in nylon fiber, color matching backshell, are available upon request and with a surcharge. Back and seat can be ordered in different colors of the same upholstery, with a surcharge.



SEK ART. 4849	A	B COM	C COL	D	E	F	G	H	I	J	K	L	M	ES
POWDERCOATED ALUMINIUM	10156	10358	10560	10762	10964	11166	11368	11570	11772	11974	12176	12378	12580	13371
	A	B COM	C COL	D	E	F	G	H	I	J	K	L	M	
Upholstery: two colors	+ 143	+ 238	+ 333	+ 428	+ 523	+ 618	+ 713	+ 808	+ 903	+ 998	+ 1093	+ 1188	+ 1283	
Armrest 2D	+ 2000													
Armrest	+ 727													

SHIPMENT DETAILS	TECHNICAL SPECIFICATIONS	RESISTANCE TEST
<b>Art.4849</b> 1 pz = 1  - kg 21/ m³ 0,4	<b>Art.4849</b> COL requirement m² 1.64 H 140 cm. COM Meterage m 0.72 *Classe 1, 2, 11M: fire retardant version available with surcharge and eventual minimum batch	
<b>FIRE RETARDANT TEST</b> Classe 11M Omologazione Italia Canvas 2 Kvadrat. Remix 3 Kvadrat. Steelcut Trio 3 Kvadrat. Coated fabric Valencia Spradling. • FIRE RETARDANT VERSION WITH SURCHARGE * Classe 11M Omologazione Italia Canvas 2 Kvadrat. Elmosoft.		

Frame Base



Polypropylene



Armrest

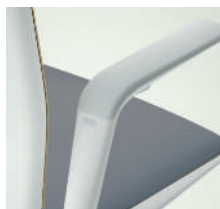

Armrest 2D



Armrest





# Kinesit

Design by Lievore Altherr Molina, 2014



Chair with powder coated aluminum 5 way swivel base on castors (available for hard and soft floors, color matching base), fitted with gas-lift mechanism for height adjustment. Seat with built-in self-tensioning weight response mechanism, backrest with 3-position recline, adjustable lumbar support breathing up to 60 mm. Back and seat completely upholstered in leather, customer's leather, coated fabric, fabric or customer's fabric. Fixed or adjustable armrests in nylon fiber, color matching backshell, are available upon request and with a surcharge. Back and seat can be ordered in different colors of the same upholstery, with a surcharge.

SEK ART. 4852	A	B COM	C COL	D	E	F	G	H	I	J	K	L	M	ES
POWDERCOATED ALUMINIUM	11026	11419	11812	12205	12598	12991	13384	13777	14170	14563	14956	15349	15742	17229
	A	B COM	C COL	D	E	F	G	H	I	J	K	L	M	
Upholstery: two colors	+ 143	+ 238	+ 333	+ 428	+ 523	+ 618	+ 713	+ 808	+ 903	+ 998	+ 1093	+ 1188	+ 1283	
Armrest 2D	+ 2000													
Armrest	+ 727													

SHIPMENT DETAILS	TECHNICAL SPECIFICATIONS	RESISTANCE TEST
<b>Art.4852</b> 1 pz = 1  - kg 21/ m³ 0,4	<b>Art.4852</b> COL requirement m² 2.44 H 140 cm. COM Meterage m 1.38 *Classe 1, 2, 11M: fire retardant version available with surcharge and eventual minimum batch	
<b>FIRE RETARDANT TEST</b> Classe 11M Omologazione Italia Coated fabric Valencia Spradling. • FIRE RETARDANT VERSION WITH SURCHARGE * Classe 11M Omologazione Italia Canvas 2 Kvadrat. Elmosoft. Remix 3 Kvadrat. Steelcut Trio 3 Kvadrat.		

Frame Base



Polypropylene



Armrest

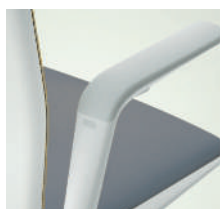

Armrest 2D



Armrest



# Kinesit Met

Design by Lievore Altherr Molina, 2021

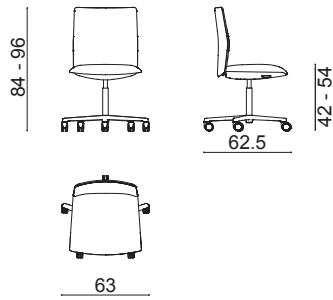

Chair with powder coated aluminum 5 way swivel base on self-braking castors (black, available for hard and soft floors), fitted with gas-lift mechanism for height adjustment. Seat with built-in self-tensioning weight response mechanism, backrest with 3-position recline, adjustable lumbar support breathing up to 60 mm. Low backrest and seat both with fabric, leather, coated fabric or customer's own material. On request and with an additional charge, fixed aluminium armrests are available in the same finishes as the base and the seat and backrest can be made using different shades of the same cover.

SEK ART. 4863	A	B COM	C COL	D	E	F	G	H	I	J	K	L	M	ES
POWDERCOATED ALUMINIUM	13538	13931	14324	14717	15110	15503	15896	16289	16682	17075	17468	17861	18254	19658
	A	B COM	C COL	D	E	F	G	H	I	J	K	L	M	
Upholstery: two colors	+ 143	+ 238	+ 333	+ 428	+ 523	+ 618	+ 713	+ 808	+ 903	+ 998	+ 1093	+ 1188	+ 1283	
Aluminium armrests	+ 2620													

SHIPMENT DETAILS	TECHNICAL SPECIFICATIONS	RESISTANCE TEST
<b>Art.4863</b> 1 pz = 1  - kg 21/ m³ 0,401	<b>Art.4863</b> COL requirement m² 2.44 H 140 cm. COM Meterage m 1.38 *Classe 1, 2, 1IM: fire retardant version available with surcharge and eventual minimum batch	
<b>FIRE RETARDANT TEST</b> • FIRE RETARDANT VERSION WITH SURCHARGE * Classe 1IM Omologazione Italia Canvas 2 Kvadrat. Elmosoft. Remix 3 Kvadrat. Steelcut Trio 3 Kvadrat.		

Frame Base



Armrest



Aluminium armrests



# Kinesit

Design by Lievore Altherr Molina, 2014

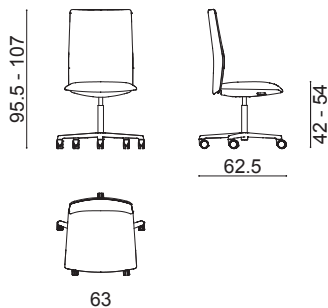

Chair with powder coated aluminum 5 way swivel base on castors (available for hard and soft floors, color matching with base), fitted with gas-lift mechanism for height adjustment. Seat with built-in self-tensioning weight response mechanism, backrest with 3-position recline, adjustable lumbar support breathing up to 60 mm. Medium backrest with front in polyester mesh in the same color as the backshell (black or white). Seat upholstered in leather, customer's leather, coated fabric, fabric or customer's fabric. Fixed or adjustable armrests in nylon fiber, color matching backshell, are available upon request and with a surcharge.



SEK ART. 4855	A	B COM	C COL	D	E	F	G	H	I	J	K	L	M	ES
POWDERCOATED ALUMINIUM	9812	10014	10216	10418	10620	10822	11024	11226	11428	11630	11832	12034	12236	13002
Armrest 2D	+ 2000													
Armrest	+ 727													

SHIPMENT DETAILS	TECHNICAL SPECIFICATIONS	RESISTANCE TEST
<b>Art.4855</b> 1 pz = 1  - kg 22/ m³ 0,45	<b>Art.4855</b> COL requirement m² 0.85 H 140 cm. COM Meterage m 0.72	
<b>FIRE RETARDANT TEST</b> Classe 11M Omologazione Italia Canvas 2 Kvadrat. Remix 3 Kvadrat. Steelcut Trio 3 Kvadrat. Coated fabric Valencia Spradling.		

Frame Base



Polypropylene



Armrest

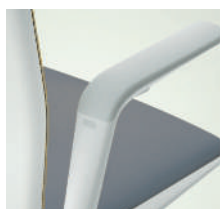

Armrest 2D



Armrest



# Kinesit

Design by Lievore Altherr Molina, 2014

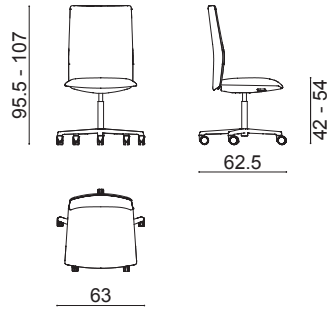

Chair with powder coated aluminum 5 way swivel base on castors (available for hard and soft floors, color matching base), fitted with gas-lift mechanism for height adjustment. Seat with built-in self-tensioning weight response mechanism, backrest with 3-position recline, adjustable lumbar support breathing up to 60 mm. Medium backrest with visible backshell (available in black and white) and front back and seat upholstered in leather, customer's leather, coated fabric, fabric or customer's fabric. Fixed or adjustable armrests in nylon fiber, color matching backshell, are available upon request and with a surcharge. Back and seat can be ordered in different colors of the same upholstery, with a surcharge.



SEK ART. 4858	A	B COM	C COL	D	E	F	G	H	I	J	K	L	M	ES
POWDERCOATED ALUMINIUM	10419	10645	10871	11097	11323	11549	11775	12001	12227	12453	12679	12905	13131	14063
	A	B COM	C COL	D	E	F	G	H	I	J	K	L	M	
Upholstery: two colors	+ 143	+ 238	+ 333	+ 428	+ 523	+ 618	+ 713	+ 808	+ 903	+ 998	+ 1093	+ 1188	+ 1283	
Armrest 2D	+ 2000													
Armrest	+ 727													

SHIPMENT DETAILS	TECHNICAL SPECIFICATIONS	RESISTANCE TEST
<b>Art.4858</b> 1 pz = 1  - kg 22/ m³ 0,45	<b>Art.4858</b> COL requirement m² 1.74 H 140 cm. COM Meterage m 0.83 *Classe 1, 2, 11M: fire retardant version available with surcharge and eventual minimum batch	
<b>FIRE RETARDANT TEST</b> Classe 11M Omologazione Italia Canvas 2 Kvadrat. Remix 3 Kvadrat. Steelcut Trio 3 Kvadrat. Coated fabric Valencia Spradling. • FIRE RETARDANT VERSION WITH SURCHARGE * Classe 11M Omologazione Italia Canvas 2 Kvadrat. Elmosoft.		

Frame Base



Polypropylene



Armrest

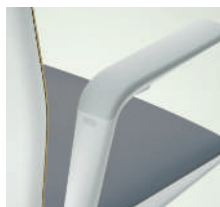

Armrest 2D



Armrest



# Kinesit

Design by Lievore Altherr Molina, 2014

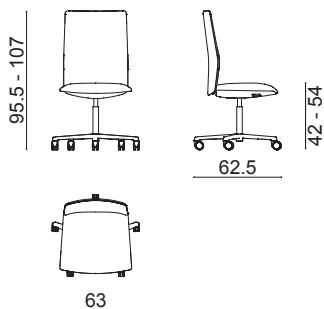

Chair with powder coated aluminum 5 way swivel base on castors (available for hard and soft floors, color matching base), fitted with gas-lift mechanism for height adjustment. Seat with built-in self-tensioning weight response mechanism, backrest with 3-position recline, adjustable lumbar support breathing up to 60 mm. Medium back and seat completely upholstered in leather, customer's leather, coated fabric, fabric or customer's fabric. Fixed or adjustable armrests in nylon fiber, color matching backshell, are available upon request and with a surcharge. Back and seat can be ordered in different colors of the same upholstery, with a surcharge.

SEK ART. 4861	A	B COM	C COL	D	E	F	G	H	I	J	K	L	M	ES
POWDERCOATED ALUMINIUM	11538	11967	12396	12825	13254	13683	14112	14541	14970	15399	15828	16257	16686	18182
	A	B COM	C COL	D	E	F	G	H	I	J	K	L	M	
Upholstery: two colors	+ 143	+ 238	+ 333	+ 428	+ 523	+ 618	+ 713	+ 808	+ 903	+ 998	+ 1093	+ 1188	+ 1283	
Armrest 2D	+ 2000													
Armrest	+ 727													

SHIPMENT DETAILS	TECHNICAL SPECIFICATIONS	RESISTANCE TEST
<b>Art.4861</b> 1 pz = 1  - kg 22/ m³ 0,45	<b>Art.4861</b> COL requirement m² 2.7 H 140 cm. COM Meterage m 1.49 *Classe 1, 2, 11M: fire retardant version available with surcharge and eventual minimum batch	
<b>FIRE RETARDANT TEST</b> Classe 11M Omologazione Italia Coated fabric Valencia Spradling. • FIRE RETARDANT VERSION WITH SURCHARGE * Classe 11M Omologazione Italia Canvas 2 Kvadrat. Elmosoft. Remix 3 Kvadrat. Steelcut Trio 3 Kvadrat.		

Frame Base



Polypropylene



Armrest

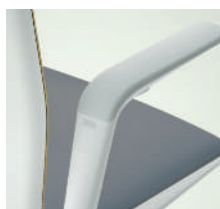

Armrest 2D



Armrest



# Kinesit Met

Design by Lievore Altherr Molina, 2021

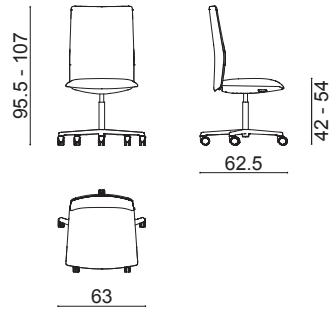

Chair with powder coated aluminum 5 way swivel base on self-braking castors (black, available for hard and soft floors), fitted with gas-lift mechanism for height adjustment. Seat with built-in self-tensioning weight response mechanism, backrest with 3-position recline, adjustable lumbar support breathing up to 60 mm. Mid-backrest and seat both with fabric, leather, coated fabric or customer's own material. On request and with an additional charge, fixed aluminium armrests are available in the same finishes as the base and the seat and backrest can be made using different shades of the same cover.

SEK ART. 4864	A	B COM	C COL	D	E	F	G	H	I	J	K	L	M	ES
POWDERCOATED ALUMINIUM	14026	14455	14884	15313	15742	16171	16600	17029	17458	17887	18316	18745	19174	20742
	A	B COM	C COL	D	E	F	G	H	I	J	K	L	M	
Upholstery: two colors	+ 143	+ 238	+ 333	+ 428	+ 523	+ 618	+ 713	+ 808	+ 903	+ 998	+ 1093	+ 1188	+ 1283	
Aluminium armrests	+ 2620													

SHIPMENT DETAILS	TECHNICAL SPECIFICATIONS	RESISTANCE TEST
<b>Art.4864</b> 1 pz = 1  - kg 22/ m³ 0,448	<b>Art.4864</b> COL requirement m² 2.7 H 140 cm. COM Meterage m 1.49 *Classe 1, 2, 11M: fire retardant version available with surcharge and eventual minimum batch	
<b>FIRE RETARDANT TEST</b> * FIRE RETARDANT VERSION WITH SURCHARGE * Classe 11M Omologazione Italia Canvas 2 Kvadrat. Elmosoft. Remix 3 Kvadrat. Steelcut Trio 3 Kvadrat.		

Frame Base



Armrest



Aluminium armrests



# Kinesit

Design by Lievore Altherr Molina, 2014

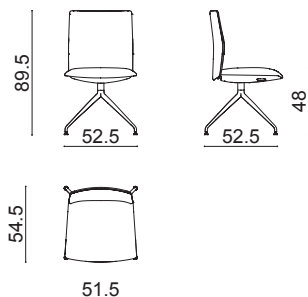

Chair with aluminum swivel trestle base on glides. Seat with built-in self-tensioning weight response mechanism, backrest with 3-position recline, adjustable lumbar support breathing up to 60 mm. Low backrest with visible backshell (available in black or white), and front in polyester mesh in matching color. Seat upholstered in leather, customer's leather, coated fabric, fabric or customer's fabric. Fixed or 2D adjustable armrests in nylon fiber, color matching backshell, are available upon request and with a surcharge.



Accessories:  
Set of glides Art. 2015

SEK ART. 4843	A	B COM	C COL	D	E	F	G	H	I	J	K	L	M	ES
POLISHED ALUMINIUM / POWDERCOATED	8668	8870	9072	9274	9476	9678	9880	10082	10284	10486	10688	10890	11092	11883
Armrest 2D	+ 2000													
Armrest	+ 727													

SHIPMENT DETAILS	TECHNICAL SPECIFICATIONS	RESISTANCE TEST
<b>Art.4843</b> 1 pz = 1  - kg 21/ m³ 0,401	<b>Art.4843</b> COL requirement m² 0.85 H 140 cm. COM Meterage m 0.72	
<b>FIRE RETARDANT TEST</b> Classe 11M Omologazione Italia Canvas 2 Kvadrat. Remix 3 Kvadrat. Steelcut Trio 3 Kvadrat. Coated fabric Valencia Spradling.		

Frame Base



Polypropylene



Armrest

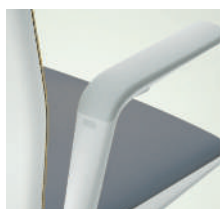

Armrest 2D



Armrest



# Kinesit

Design by Lievore Altherr Molina, 2014

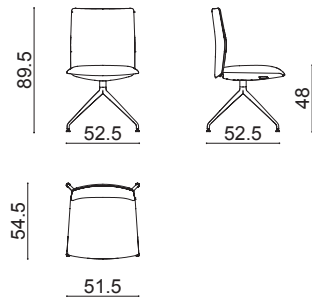

Chair with aluminum swivel trestle base on glides. Seat with built-in self-tensioning weight response mechanism, backrest with 3-position recline, adjustable lumbar support breathing up to 60 mm. Low backrest with visible backshell (available in black and white) and front back and seat upholstered in leather, customer's leather, coated fabric, fabric or customer's fabric. Fixed or 2D adjustable armrests in nylon fiber, color matching with backshell, color matching backshell, are available upon request and with a surcharge. Back and seat can be ordered in different colors of the same upholstery, with a surcharge.



Accessories:  
Set of glides Art. 2015

SEK ART. 4846	A	B COM	C COL	D	E	F	G	H	I	J	K	L	M	ES
POLISHED ALUMINIUM / POWDERCOATED	9168	9370	9572	9774	9976	10178	10380	10582	10784	10986	11188	11390	11592	12383
	A	B COM	C COL	D	E	F	G	H	I	J	K	L	M	
Upholstery: two colors	+ 143	+ 238	+ 333	+ 428	+ 523	+ 618	+ 713	+ 808	+ 903	+ 998	+ 1093	+ 1188	+ 1283	
Armrest 2D	+ 2000													
Armrest	+ 727													

SHIPMENT DETAILS	TECHNICAL SPECIFICATIONS	RESISTANCE TEST
<b>Art.4846</b> 1 pz = 1  - kg 21/ m³ 0,4	<b>Art.4846</b> COL requirement m² 1.64 H 140 cm. COM Meterage m 0.72 *Classe 1, 2, 11M: fire retardant version available with surcharge and eventual minimum batch	
<b>FIRE RETARDANT TEST</b> Classe 11M Omologazione Italia Canvas 2 Kvadrat, Remix 3 Kvadrat, Steelcut Trio 3 Kvadrat, Coated fabric Valencia Spradling. • FIRE RETARDANT VERSION WITH SURCHARGE * Classe 11M Omologazione Italia Canvas 2 Kvadrat, Elmosoft.		

Frame Base



Polypropylene



Armrest

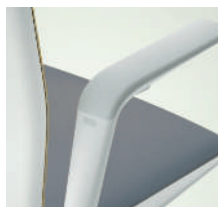

Armrest 2D



Armrest





# Kinesit

Design by Lievore Altherr Molina, 2014

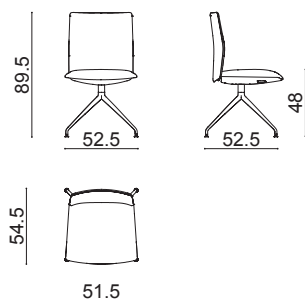

Chair with aluminum swivel trestle base on glides. Seat with built-in self-tensioning weight response mechanism, backrest with 3-position recline, adjustable lumbar support breathing up to 60 mm. Back and seat completely upholstered in leather, customer's leather, coated fabric, fabric or customer's fabric. Fixed or 2D adjustable armrests in nylon fiber, color matching backshell, are available upon request and with a surcharge. Back and seat can be ordered in different colors of the same upholstery, with a surcharge.

Accessories:  
Set of glides Art. 2015



SEK ART. 4850	A	B COM	C COL	D	E	F	G	H	I	J	K	L	M	ES
POLISHED ALUMINIUM / POWDERCOATED	10049	10442	10835	11228	11621	12014	12407	12800	13193	13586	13979	14372	14765	16229
	A	B COM	C COL	D	E	F	G	H	I	J	K	L	M	
Upholstery: two colors	+ 143	+ 238	+ 333	+ 428	+ 523	+ 618	+ 713	+ 808	+ 903	+ 998	+ 1093	+ 1188	+ 1283	
Armrest 2D	+ 2000													
Armrest	+ 727													

SHIPMENT DETAILS	TECHNICAL SPECIFICATIONS	RESISTANCE TEST
<b>Art.4850</b> 1 pz = 1  - kg 21/ m³ 0,4	<b>Art.4850</b> COL requirement m² 2.44 H 140 cm. COM Meterage m 1.38 *Classe 1, 2, 11M: fire retardant version available with surcharge and eventual minimum batch	
<b>FIRE RETARDANT TEST</b> Classe 11M Omologazione Italia Coated fabric Valencia Spradling. • FIRE RETARDANT VERSION WITH SURCHARGE * Classe 11M Omologazione Italia Canvas 2 Kvadrat. Elmosoft. Remix 3 Kvadrat. Steelcut Trio 3 Kvadrat.		

Frame Base



Polypropylene



Armrest

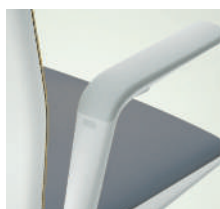

Armrest 2D



Armrest



# Kinesit

Design by Lievore Altherr Molina, 2014

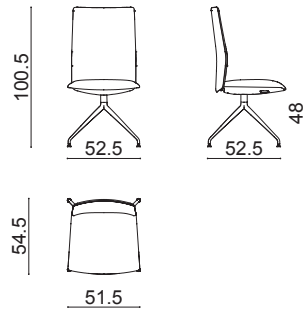

Chair with aluminum swivel trestle base on glides. Seat with built-in self-tensioning weight response mechanism, backrest with 3-position recline, adjustable lumbar support breathing up to 60 mm. Medium backrest with visible backshell and front in polyester mesh in matching color (black or white). Seat upholstered in leather, customer's leather, coated fabric, fabric or customer's fabric. Fixed or 2D adjustable armrests in nylon fiber, color matching backshell, are available upon request and with a surcharge.



Accessories:  
Set of glides Art. 2015

SEK ART. 4853	A	B COM	C COL	D	E	F	G	H	I	J	K	L	M	ES
POLISHED ALUMINIUM / POWDERCOATED	8812	9014	9216	9418	9620	9822	10024	10226	10428	10630	10832	11034	11236	12026
Armrest 2D	+ 2000													
Armrest	+ 727													

SHIPMENT DETAILS	TECHNICAL SPECIFICATIONS	RESISTANCE TEST
<b>Art.4853</b> 1 pz = 1  - kg 22/ m³ 0,45	<b>Art.4853</b> COL requirement m² 0.85 H 140 cm. COM Meterage m 0.72	

**FIRE RETARDANT TEST**  
 Classe 1IM Omologazione Italia Canvas 2 Kvadrat. Remix 3 Kvadrat. Steelcut Trio 3 Kvadrat. Coated fabric Valencia Spradling.

Frame Base



Polypropylene



Armrest

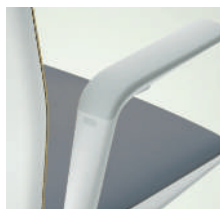

Armrest 2D



Armrest



# Kinesit

Design by Lievore Altherr Molina, 2014

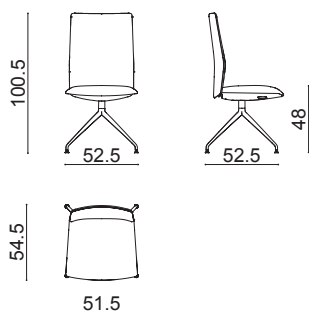

Chair with aluminum swivel trestle base on glides. Seat with built-in self-tensioning weight response mechanism, backrest with 3-position recline, adjustable lumbar support breathing up to 60 mm. Medium backrest with visible backshell (available in black and white) and front back and seat upholstered in leather, customer's leather, coated fabric, fabric or customer's fabric. Fixed or 2D adjustable armrests in nylon fiber, color matching backshell, are available upon request and with a surcharge. Back and seat can be ordered in different colors of the same upholstery, with a surcharge.



Accessories:  
Set of glides Art. 2015

SEK ART. 4856	A	B COM	C COL	D	E	F	G	H	I	J	K	L	M	ES
POLISHED ALUMINIUM / POWDERCOATED	9407	9633	9859	10085	10311	10537	10763	10989	11215	11441	11667	11893	12119	13085
	A	B COM	C COL	D	E	F	G	H	I	J	K	L	M	
Upholstery: two colors	+ 143	+ 238	+ 333	+ 428	+ 523	+ 618	+ 713	+ 808	+ 903	+ 998	+ 1093	+ 1188	+ 1283	
Armrest 2D	+ 2000													
Armrest	+ 727													

SHIPMENT DETAILS	TECHNICAL SPECIFICATIONS	RESISTANCE TEST
<b>Art.4856</b> 1 pz = 1  - kg 22/ m³ 0,45	<b>Art.4856</b> COL requirement m² 1.74 H 140 cm. COM Meterage m 0.83 *Classe 1, 2, 11M: fire retardant version available with surcharge and eventual minimum batch	
<b>FIRE RETARDANT TEST</b> Classe 11M Omologazione Italia Canvas 2 Kvadrat, Remix 3 Kvadrat, Steelcut Trio 3 Kvadrat, Coated fabric Valencia Spradling. • FIRE RETARDANT VERSION WITH SURCHARGE * Classe 11M Omologazione Italia Canvas 2 Kvadrat, Elmosoft.		

Frame Base



Polypropylene



Armrest

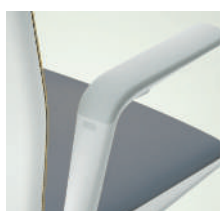

Armrest 2D



Armrest



# Kinesit

Design by Lievore Altherr Molina, 2014

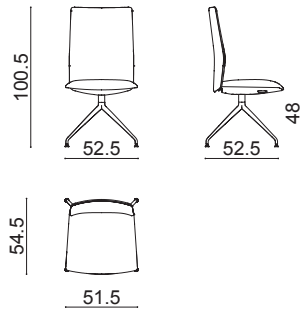

Chair with aluminum swivel trestle base on glides. Seat with built-in self-tensioning weight response mechanism, backrest with 3-position recline, adjustable lumbar support breathing up to 60 mm. Medium back and seat completely upholstered in leather, customer's leather, coated fabric, fabric or customer's fabric. Fixed or 2D adjustable armrests in nylon fiber are available upon request and with a surcharge. Back and seat can be ordered in different colors of the same upholstery, with a surcharge.

Accessories:  
Set of glides Art. 2015



SEK ART. 4859	A	B COM	C COL	D	E	F	G	H	I	J	K	L	M	ES
POLISHED ALUMINIUM / POWDERCOATED	10561	10990	11419	11848	12277	12706	13135	13564	13993	14422	14851	15280	15709	17205
	A	B COM	C COL	D	E	F	G	H	I	J	K	L	M	
Upholstery: two colors	+ 143	+ 238	+ 333	+ 428	+ 523	+ 618	+ 713	+ 808	+ 903	+ 998	+ 1093	+ 1188	+ 1283	
Armrest 2D	+ 2000													
Armrest	+ 727													

SHIPMENT DETAILS	TECHNICAL SPECIFICATIONS	RESISTANCE TEST
<b>Art.4859</b> 1 pz = 1  - kg 22/ m³ 0,45	<b>Art.4859</b> COL requirement m² 2,7 H 140 cm. COM Meterage m 1,49 *Classe 1, 2, 11M: fire retardant version available with surcharge and eventual minimum batch	
<b>FIRE RETARDANT TEST</b> Classe 11M Omologazione Italia Coated fabric Valencia Spradling. • FIRE RETARDANT VERSION WITH SURCHARGE * Classe 11M Omologazione Italia Canvas 2 Kvadrat. Elmosoft. Remix 3 Kvadrat. Steelcut Trio 3 Kvadrat.		

Frame Base



Polypropylene



Armrest

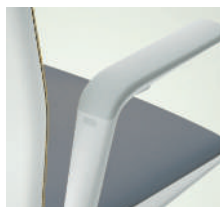

Armrest 2D



Armrest



# Kinesit

Design by Lievore Altherr Molina, 2014

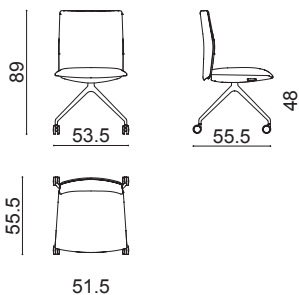

Chair with aluminum fixed trestle base on self-breaking castors (color matching base). Seat with built-in self-tensioning weight response mechanism, backrest with 3-position recline, adjustable lumbar support breathing up to 60 mm. Low backrest with visible backshell (available in black or white), front in polyester mesh in matching color. Seat upholstered in leather, customer's leather, coated fabric, fabric or customer's fabric. Fixed or 2D adjustable armrests in nylon fiber, color matching backshell, are available upon request and with a surcharge.



SEK ART. 4844	A	B COM	C COL	D	E	F	G	H	I	J	K	L	M	ES
POLISHED ALUMINIUM / POWDERCOATED	8847	9049	9251	9453	9655	9857	10059	10261	10463	10665	10867	11069	11271	12050
Armrest 2D	+ 2000													
Armrest	+ 727													

SHIPMENT DETAILS	TECHNICAL SPECIFICATIONS	RESISTANCE TEST
<b>Art.4844</b> 1 pz = 1  - kg 21/ m³ 0,4	<b>Art.4844</b> COL requirement m² 0.85 H 140 cm. COM Meterage m 0.72	

**FIRE RETARDANT TEST**  
 Classe 11M Omologazione Italia Canvas 2 Kvadrat. Remix 3 Kvadrat. Steelcut Trio 3 Kvadrat. Coated fabric Valencia Spradling.

Frame Base



Polypropylene



Armrest

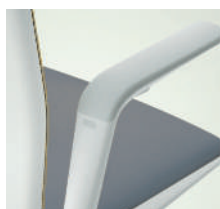

Armrest 2D



Armrest



# Kinesit

Design by Lievore Altherr Molina, 2014

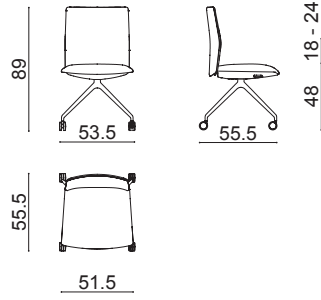

Chair with aluminum fixed trestle base on self-breaking castors (color matching base). Seat with built-in self-tensioning weight response mechanism, backrest with 3-position recline, adjustable lumbar support breathing up to 60 mm. Low backrest with visible backshell (available in black and white) and front back and seat upholstered in leather, customer's leather, coated fabric, fabric or customer's fabric. Fixed or adjustable armrests in nylon fiber, color matching backshell, are available upon request and with a surcharge. Back and seat can be ordered in different colors of the same upholstery, with a surcharge.

SEK ART. 4847	A	B COM	C COL	D	E	F	G	H	I	J	K	L	M	ES
POLISHED ALUMINIUM / POWDERCOATED	9347	9549	9751	9953	10155	10357	10559	10761	10963	11165	11367	11569	11771	12573
	A	B COM	C COL	D	E	F	G	H	I	J	K	L	M	
Upholstery: two colors	+ 143	+ 238	+ 333	+ 428	+ 523	+ 618	+ 713	+ 808	+ 903	+ 998	+ 1093	+ 1188	+ 1283	
Armrest 2D	+ 2000													
Armrest	+ 727													

SHIPMENT DETAILS	TECHNICAL SPECIFICATIONS	RESISTANCE TEST
<b>Art.4847</b> 1 pz = 1  - kg 21/ m³ 0,4	<b>Art.4847</b> COL requirement m² 1.64 H 140 cm. COM Meterage m 0.72 *Classe 1, 2, 11M: fire retardant version available with surcharge and eventual minimum batch	
<b>FIRE RETARDANT TEST</b> Classe 11M Omologazione Italia Canvas 2 Kvadrat. Remix 3 Kvadrat. Steelcut Trio 3 Kvadrat. Coated fabric Valencia Spradling. • FIRE RETARDANT VERSION WITH SURCHARGE * Classe 11M Omologazione Italia Canvas 2 Kvadrat. Elmosoft.		

Frame Base



Polypropylene



Armrest

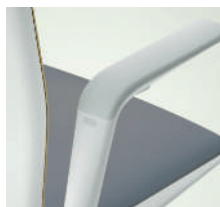

Armrest 2D



Armrest



# Kinesit

Design by Lievore Altherr Molina, 2014

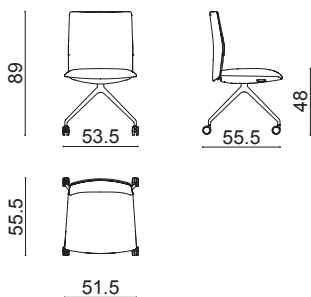

Chair with aluminum fixed trestle base on self-breaking castors (color matching base). Seat with built-in self-tensioning weight response mechanism, backrest with 3-position recline, adjustable lumbar support breathing up to 60 mm. Back and seat completely upholstered in leather, customer's leather, coated fabric, fabric or customer's fabric. Fixed or adjustable armrests in nylon fiber, color matching backshell, are available upon request and with a surcharge. Back and seat can be ordered in different colors of the same upholstery, with a surcharge.



SEK ART. 4851	A	B COM	C COL	D	E	F	G	H	I	J	K	L	M	ES
POLISHED ALUMINIUM / POWDERCOATED	10228	10621	11014	11407	11800	12193	12586	12979	13372	13765	14158	14551	14944	16407
	A	B COM	C COL	D	E	F	G	H	I	J	K	L	M	
Upholstery: two colors	+ 143	+ 238	+ 333	+ 428	+ 523	+ 618	+ 713	+ 808	+ 903	+ 998	+ 1093	+ 1188	+ 1283	
Armrest 2D	+ 2000													
Armrest	+ 727													

SHIPMENT DETAILS	TECHNICAL SPECIFICATIONS	RESISTANCE TEST
<b>Art.4851</b> 1 pz = 1  - kg 21/ m³ 0,4	<b>Art.4851</b> COL requirement m² 2.44 H 140 cm. COM Meterage m 1.38 *Classe 1, 2, 11M: fire retardant version available with surcharge and eventual minimum batch	
<b>FIRE RETARDANT TEST</b> Classe 11M Omologazione Italia Coated fabric Valencia Spradling. • FIRE RETARDANT VERSION WITH SURCHARGE * Classe 11M Omologazione Italia Canvas 2 Kvadrat. Elmosoft. Remix 3 Kvadrat. Steelcut Trio 3 Kvadrat.		

Frame Base



Polypropylene



Armrest

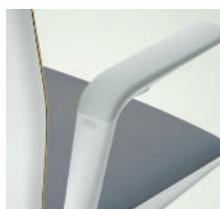

Armrest 2D



Armrest



# Kinesit

Design by Lievore Altherr Molina, 2014

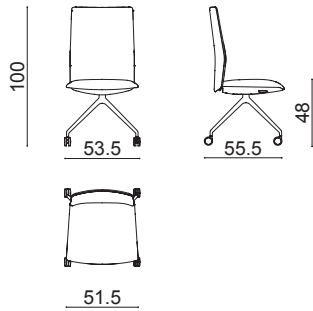

Chair with aluminum fixed trestle base on self-breaking castors (color matching base). Seat with built-in self-tensioning weight response mechanism, backrest (color matching base) with 3-position recline, adjustable lumbar support breathing up to 60 mm. Medium backrest with front in polyester mesh in the same color as the backshell (black or white). Seat upholstered in leather, customer's leather, coated fabric, fabric or customer's fabric. Fixed or adjustable armrests in nylon fiber, color matching backshell, are available upon request and with a surcharge.



SEK ART. 4854	A	B COM	C COL	D	E	F	G	H	I	J	K	L	M	ES
POLISHED ALUMINIUM / POWDERCOATED	9014	9216	9418	9620	9822	10024	10226	10428	10630	10832	11034	11236	11438	12193
Armrest 2D	+ 2000													
Armrest	+ 727													

SHIPMENT DETAILS	TECHNICAL SPECIFICATIONS	RESISTANCE TEST
<b>Art.4854</b> 1 pz = 1  - kg 22/ m³ 0,45	<b>Art.4854</b> COL requirement m² 0.85 H 140 cm. COM Meterage m 0.72	
<b>FIRE RETARDANT TEST</b> Classe 1IM Omologazione Italia Canvas 2 Kvadrat. Remix 3 Kvadrat. Steelcut Trio 3 Kvadrat. Coated fabric Valencia Spradling.		

Frame Base



Polypropylene



Armrest

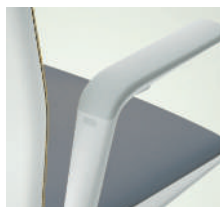

Armrest 2D



Armrest





# Kinesit

Design by Lievore Altherr Molina, 2014



Chair with aluminum fixed trestle base on self-breaking castors (color matching base). Seat with built-in self-tensioning weight response mechanism, backrest with 3-position recline, adjustable lumbar support breathing up to 60 mm. Medium backrest with visible backshell (available in black and white) and front back and seat upholstered in leather, customer's leather, coated fabric, fabric or customer's fabric. Fixed or adjustable armrests in nylon fiber, color matching backshell, are available upon request and with a surcharge. Back and seat can be ordered in different colors of the same upholstery, with a surcharge.

SEK ART. 4857	A	B COM	C COL	D	E	F	G	H	I	J	K	L	M	ES
POLISHED ALUMINIUM / POWDERCOATED	9597	9823	10049	10275	10501	10727	10953	11179	11405	11631	11857	12083	12309	13265
	A	B COM	C COL	D	E	F	G	H	I	J	K	L	M	
Upholstery: two colors	+ 143	+ 238	+ 333	+ 428	+ 523	+ 618	+ 713	+ 808	+ 903	+ 998	+ 1093	+ 1188	+ 1283	
Armrest 2D	+ 2000													
Armrest	+ 727													

SHIPMENT DETAILS	TECHNICAL SPECIFICATIONS	RESISTANCE TEST
<b>Art.4857</b> 1 pz = 1  - kg 22/ m³ 0,45	<b>Art.4857</b> COL requirement m² 1.74 H 140 cm. COM Meterage m 0.83 *Classe 1, 2, 11M: fire retardant version available with surcharge and eventual minimum batch	
<b>FIRE RETARDANT TEST</b> Classe 11M Omologazione Italia Canvas 2 Kvadrat, Remix 3 Kvadrat, Steelcut Trio 3 Kvadrat, Coated fabric Valencia Spradling. • FIRE RETARDANT VERSION WITH SURCHARGE * Classe 11M Omologazione Italia Canvas 2 Kvadrat, Elmosoft.		

Frame Base



Polypropylene



Armrest

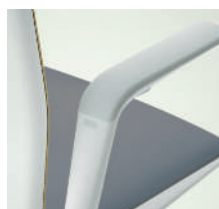

Armrest 2D



Armrest



# Kinesit

Design by Lievore Altherr Molina, 2014

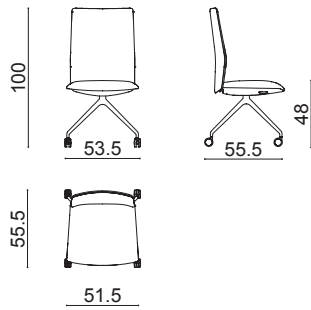

Chair with aluminum fixed trestle base on self-breaking castors (color matching base). Seat with built-in self-tensioning weight response mechanism, backrest with 3-position recline, adjustable lumbar support breathing up to 60 mm. Medium back and seat completely upholstered in leather, customer's leather, coated fabric, fabric or customer's fabric. Fixed or adjustable armrests in nylon fiber, color matching backshell, are available upon request and with a surcharge. Back and seat can be ordered in different colors of the same upholstery, with a surcharge.



SEK ART. 4860	A	B COM	C COL	D	E	F	G	H	I	J	K	L	M	ES
POLISHED ALUMINIUM / POWDERCOATED	10741	11170	11599	12028	12457	12886	13315	13744	14173	14602	15031	15460	15889	17385
	A	B COM	C COL	D	E	F	G	H	I	J	K	L	M	
Upholstery: two colors	+ 143	+ 238	+ 333	+ 428	+ 523	+ 618	+ 713	+ 808	+ 903	+ 998	+ 1093	+ 1188	+ 1283	
Armrest 2D	+ 2000													
Armrest	+ 727													

SHIPMENT DETAILS	TECHNICAL SPECIFICATIONS	RESISTANCE TEST
<b>Art.4860</b> 1 pz = 1  - kg 22/ m <sup>3</sup> 0,45	<b>Art.4860</b> COL requirement m <sup>2</sup> 2,7 H 140 cm. COM Meterage m 1,49 *Classe 1, 2, 11M: fire retardant version available with surcharge and eventual minimum batch	
<b>FIRE RETARDANT TEST</b> Classe 11M Omologazione Italia Coated fabric Valencia Spradling. • FIRE RETARDANT VERSION WITH SURCHARGE * Classe 11M Omologazione Italia Canvas 2 Kvadrat. Elmosoft. Remix 3 Kvadrat. Steelcut Trio 3 Kvadrat.		

Frame Base



Polypropylene



Armrest

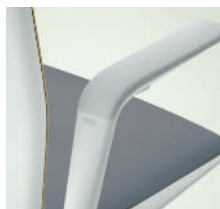

Armrest 2D



Armrest





# LEAF CHAIR

---

Design by  
Lievore Altherr Molina  
2005

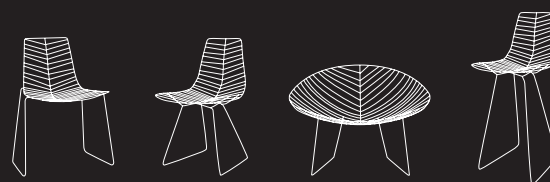

# Leaf Chair

**Collection overview**  
**Available in the Chairs and Stools section**

---

## Type



Sled



Stackable sled



Lounge sled



Counter stool  
sled



Bar stool  
sled

Seat cushions are available



Outdoor



# Leaf Table

Collection overview  
Available in the Tables section

## Type



h 50 cm



h 74 cm









h 74 cm



h 74 cm

## Base

		 h 50 cm	 h 74 cm	 h 74 cm	 h 74 cm
Top		Ø 79 cm	Ø 79 cm		
			Ø 79 cm	Ø 100 cm	
					79x79 cm

## Top finishes

— HPL



Outdoor

# Leaf

Design by Lievore Altherr Molina, 2005

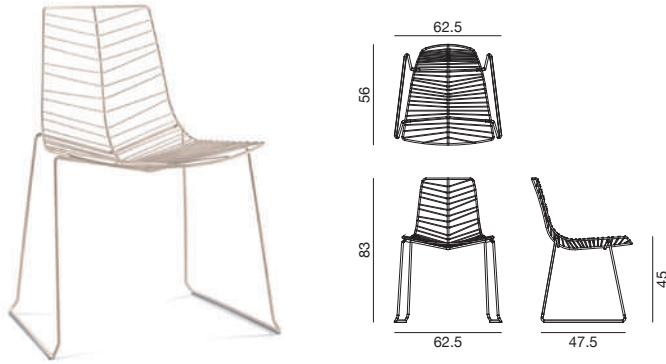

Stackable chair with sled base entirely made in powder-coated steel rod. Available in three colours: white, green and moka. Glides for wooden floors available upon request. Collection includes, coordinated with chairs, several models of table. (Leaf Table, Pricelist II).

Accessories:  
Cushion - Outdoor Art. 1807

Stackability:  
(should the weight exceed 25 kilos a handling tool must be used).  
– without tools up to 4 units

<b>SEK ART. 1801</b>	Steel	
POWDERCOATED	3879	
<b>SHIPMENT DETAILS</b>	<b>TECHNICAL SPECIFICATIONS</b>	<b>RESISTANCE TEST</b>
<b>Art.1801</b> 1 pz = 1  - kg 8,48/ m³ 0,282 4 pz = 1  - kg 23,3/ m³ 0,374		<ul style="list-style-type: none"> <li>• EN 1728:2012 - EN 16139:2013 6.15</li> <li>• EN 1728:2012 - EN 16139:2013 6.17</li> <li>• EN 1728:2012 - EN 16139:2013 6.25</li> <li>• EN 1728:2012 - EN 16139:2013 6.5</li> </ul> <ul style="list-style-type: none"> <li>• EN 1728:2012 - EN 16139:2013 6.16</li> <li>• EN 1728:2012 - EN 16139:2013 6.24</li> <li>• EN 1728:2012 - EN 16139:2013 6.4</li> </ul>
<b>FIRE RETARDANT TEST</b>		

Frame Base



# Leaf

Design by Lievore Altherr Molina, 2005

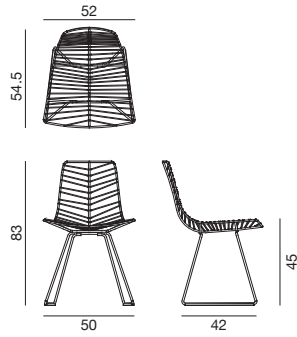

Chair with sled base entirely made in powder-coated steel rod. Available in three colours: white, green and moka. Glides for wooden floors available upon request. Collection includes, coordinated with chairs, several models of table. (Leaf Table, Pricelist II).

Accessories:  
Cushion - Outdoor Art. 1807

<b>SEK ART. 1802</b>	Steel	
POWDERCOATED	3620	
<b>SHIPMENT DETAILS</b>	<b>TECHNICAL SPECIFICATIONS</b>	<b>RESISTANCE TEST</b>
<b>Art.1802</b> 1 pz = 1  - kg 8,1/ m³ 0,294 2 pz = 1  - kg 13,7/ m³ 0,394		
<b>FIRE RETARDANT TEST</b>		

Frame Base

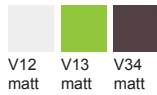

Standard: polycarbonate glide with polyurethane insert.



Upon request: polycarbonate glide with felt insert.





# Leaf Lounge

Design by Lievore Altherr Molina, 2005

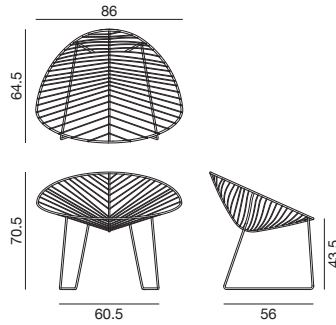

Lounge armchair with sled base entirely made in powder-coated steel rod. Available in three colours: white, green and moka. Glides for wooden floors available upon request. Collection includes, coordinated with chairs, several models of table. (Leaf Table, Pricelist II).

Accessories:  
Cushion - Outdoor Art. 1809

<b>SEK ART. 1803</b>	Steel	
POWDERCOATED	6775	
<b>SHIPMENT DETAILS</b>	<b>TECHNICAL SPECIFICATIONS</b>	<b>RESISTANCE TEST</b>
Art.1803 1 pz = 1  - kg 10,44/ m³ 0,449		
<b>FIRE RETARDANT TEST</b>		

Frame Base



Standard: polycarbonate glide with polyurethane insert.



Upon request: polycarbonate glide with felt insert.



# Leaf Counter Stool

Design by Lievore Altherr Molina, 2017

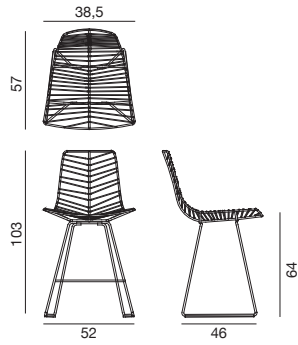

Stool with sled base entirely made in powder-coated steel rod available in three colours: white, green and moka. Glides for wooden floors available upon request. Seat height 64 cm.

Accessories:  
Cushion - Outdoor Art. 1807

<b>SEK ART. 1817</b>	Steel	
POWDERCOATED	5239	
<b>SHIPMENT DETAILS</b>	<b>TECHNICAL SPECIFICATIONS</b>	<b>RESISTANCE TEST</b>
Art.1817 1 pz = 1  - kg 11,3/ m³ 0,422		
<b>FIRE RETARDANT TEST</b>		

Frame Base



Standard: polycarbonate glide with polyurethane insert.



Upon request: polycarbonate glide with felt insert.



Outdoor use



# Leaf Bar Stool

Design by Lievore Altherr Molina, 2017

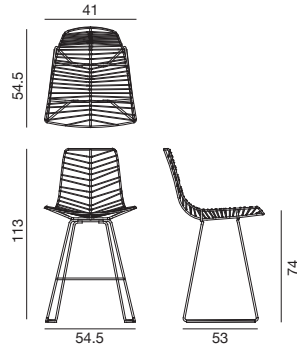

Stool with sled base entirely made in powder-coated steel rod available in three colours: white, green and moka. Glides for wooden floors available upon request. Seat height 74 cm.

Accessories:  
Cushion - Outdoor Art. 1807

<b>SEK ART. 1818</b>	Steel	
POWDERCOATED	5239	
<b>SHIPMENT DETAILS</b>	<b>TECHNICAL SPECIFICATIONS</b>	<b>RESISTANCE TEST</b>
<b>Art.1818</b> 1 pz = 1  - kg 11,6/ m³ 0,422		<ul style="list-style-type: none"> <li>• EN 1728:2012 - EN 16139:2013 6.15</li> <li>• EN 1728:2012 - EN 16139:2013 6.17</li> <li>• EN 1728:2012 - EN 16139:2013 6.24</li> <li>• EN 1728:2012 - EN 16139:2013 6.4</li> <li>• EN 1728:2012 - EN 16139:2013 6.6</li> </ul>
<b>FIRE RETARDANT TEST</b>		

Frame Base



Standard: polycarbonate glide with polyurethane insert.









Upon request: polycarbonate glide with felt insert.



## Accessories

Design by Lievore Altherr Molina

<p><b>SEK ART. 1807</b></p>  <p>Cushion Polyurethane - PU (Outdoor)</p> <p>1036</p>	<p><b>SEK ART. 1809</b></p>  <p>Cushion Polyurethane - PU (Outdoor)</p> <p>1381</p>
--	--

SHIPMENT DETAILS	TECHNICAL SPECIFICATIONS	RESISTANCE TEST
<p><b>Art. 1807</b>            1 pz = 1  - kg 1,38/ m<sup>3</sup> 0,016            4 pz = 1  - kg 4,08/ m<sup>3</sup> 0,108</p> <p><b>Art. 1809</b>            1 pz = 1  - kg 1,335/ m<sup>3</sup> 0,025            4 pz = 1  - kg 5,34/ m<sup>3</sup> 0,072</p>		
<p><b>FIRE RETARDANT TEST</b>            Classe 1IM Omologazione Italia Poliuretano autopellante. • BS5852 Sch. 5 Part 2 Poliuretano autopellante.</p>		





# MIXU

---

Design in  
collaboration with Gensler  
2021



# Mixu

## Collection overview

---

### Bases



4 steel legs



4 wooden legs

---



Counter stool  
4 steel legs



Bar stool  
4 steel legs



Counter stool  
4 wooden legs



Bar stool  
4 wooden legs

---

# Mixu

---

## Seat and backrest

### Polypropylene



Polypropylene seat and backrest – single colour version



Polypropylene seat and backrest – two colours version

### Polypropylene / Wood



Seat in wood and polypropylene backrest

### Upholstery



Upholstered seat and polypropylene backrest



Seat and backrest upholstered

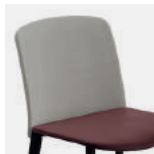

Seat upholstered in leather Elmosoft or coated fabric Valencia, backrest upholstered in fabric.

### Glides color

Chromed bases: transparent glides.  
Powdercoated bases: glides in the same color of the base



# Mixu

Design in collaboration with Gensler, 2021

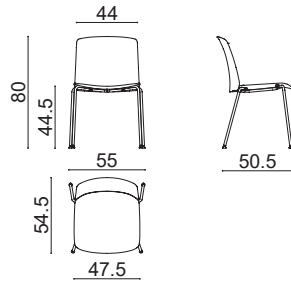

Chair on a four-legged base in chromed or powder-coated steel. Polypropylene seat made with 80% recycled materials and polypropylene backrest, both available in five colours. The finishes of the base, seat and backrest can be freely combined.

Accessories:  
Single trolley Art. 0500

Stackability:  
(should the weight exceed 25 kilos a handling tool must be used).  
– without tools up to 10 units  
– with trolley up to 20 units

<b>SEK ART. 5800</b>	PM	
CHROMED / POWDERCOATED	3062	
Product already assembled	+ 181	
<b>SHIPMENT DETAILS</b>	<b>TECHNICAL SPECIFICATIONS</b>	<b>RESISTANCE TEST</b>
<b>Art.5800</b> 1 pz = 1  - kg 7,7/ m³ 0,169 2 pz = 1  - kg 14,53/ m³ 0,234 4 pz = 1  - kg 25,53/ m³ 0,234 		<ul style="list-style-type: none"> <li>• EN 1728:2012 - EN 16139:2013 6.15</li> <li>• EN 1728:2012 - EN 16139:2013 6.4</li> <li>• EN 1022:2018</li> <li>• EN 1728:2012 - EN 16139:2013 6.16</li> <li>• EN 1728:2012 - EN 16139:2013 6.5</li> <li>• EN 1728:2012 - EN 12520:2015 5.4.2</li> </ul>
<b>Product already assembled</b> <b>Art.5800</b> 1 pz = 1  - kg 8,15/ m³ 0,326 2 pz = 1  - kg 13,65/ m³ 0,383 4 pz = 1  - kg 24,5/ m³ 0,476		
<b>FIRE RETARDANT TEST</b>		

## Frame Base



## Seat



## Backrest



# Mixu

Design in collaboration with Gensler, 2021

Chair on a four-legged base in chromed or powder-coated steel. Seat made of plywood with a reconstituted oak finish (natural or stained black) and polypropylene backrest available in five colours. The finishes of the base, seat and backrest can be freely combined.

Accessories:  
Single trolley Art. 0500

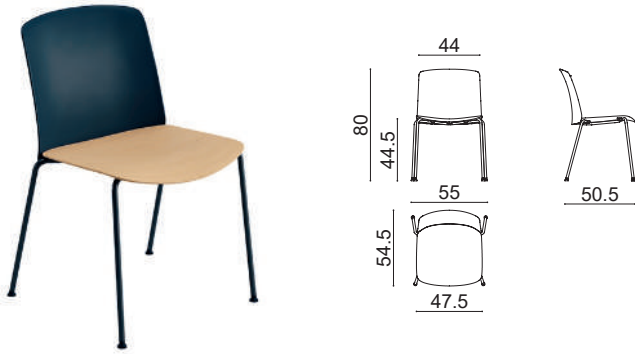

Stackability:  
(should the weight exceed 25 kilos a handling tool must be used).  
– without tools up to 8 units  
– with trolley up to 8 units

<b>SEK ART. 5801</b>	PM	
CHROMED / POWDERCOATED	4014	
Product already assembled	+ 181	
<b>SHIPMENT DETAILS</b>	<b>TECHNICAL SPECIFICATIONS</b>	<b>RESISTANCE TEST</b>
<b>Art.5801</b> 1 pz = 1  - kg 7,7/ m³ 0,169 2 pz = 1  - kg 14,53/ m³ 0,234 4 pz = 1  - kg 25,53/ m³ 0,234 		
<b>Product already assembled</b>		
<b>Art.5801</b> 1 pz = 1  - kg 8,15/ m³ 0,326 2 pz = 1  - kg 13,65/ m³ 0,383 4 pz = 1  - kg 24,5/ m³ 0,476		
<b>FIRE RETARDANT TEST</b>		

## Frame Base



## Seat

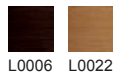

## Backrest



# Mixu

Design in collaboration with Gensler, 2021

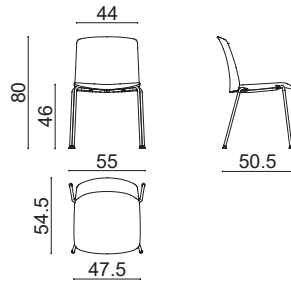

Chair on a four-legged base in chromed or powder-coated steel. Seat upholstered in fabric, leather, coated fabric or customer's own material and polypropylene backrest available in five colours.

Accessories:  
Single trolley Art. 0500  
Stacking protection pad Art. 5830

Stackability:  
(should the weight exceed 25 kilos a handling tool must be used).  
– with stacking pad, without tools up to 4 units  
– with stacking pad, with trolley up to 4 units

SEK ART. 5802	A	B COM	C COL	D	E	F	G	H	I	J	K	L	M	ES
CHROMED / POWDERCOATED	4014	4185	4356	4527	4698	4869	5040	5211	5382	5553	5724	5895	6066	6657
Product already assembled	+ 181													
SHIPMENT DETAILS	TECHNICAL SPECIFICATIONS				RESISTANCE TEST									
<b>Art.5802</b> 1 pz = 1  - kg 7,7/ m³ 0,169 2 pz = 1  - kg 14,53/ m³ 0,234 4 pz = 1  - kg 25,53/ m³ 0,234 <b>KD</b>	<b>Art.5802</b> COL requirement m² 1.08 H 140 cm. COM Meterage m 0.616													
<b>Product already assembled</b> <b>Art.5802</b> 1 pz = 1  - kg 8,15/ m³ 0,326 2 pz = 1  - kg 13,65/ m³ 0,383 4 pz = 1  - kg 24,5/ m³ 0,476														
FIRE RETARDANT TEST														

## Frame Base



## Backrest



# Mixu

Design in collaboration with Gensler, 2021

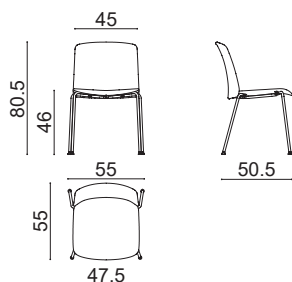

Chair on a four-legged base in chromed or powder-coated steel. Seat and backrest upholstered with fabric, leather, coated fabric or customer's own material. On request and with an additional charge, the seat and backrest can be made using different shades of the same cover.

Stackability:  
(should the weight exceed 25 kilos a handling tool must be used).

- with stacking pad, without tools up to 4 units
- with stacking pad, with trolley up to 4 units

Accessories:  
Single trolley Art. 0500  
Stacking protection pad Art. 5830

SEK ART. 5803	A	B COM	C COL	D	E	F	G	H	I	J	K	L	M	ES
CHROMED / POWDERCOATED	4831	5115	5399	5683	5967	6251	6535	6819	7103	7387	7671	7955	8239	9367
	A	B COM	C COL	D	E	F	G	H	I	J	K	L	M	ES
Upholstery: two colors	+ 45	+ 80	+ 115	+ 150	+ 185	+ 220	+ 255	+ 290	+ 325	+ 360	+ 395	+ 430	+ 465	+ 612
Product already assembled	+ 181													

SHIPMENT DETAILS	TECHNICAL SPECIFICATIONS	RESISTANCE TEST
<b>Art.5803</b> 1 pz = 1  - kg 7,7/ m³ 0,169 2 pz = 1  - kg 14,53/ m³ 0,234 4 pz = 1  - kg 25,53/ m³ 0,234 <b>KD</b>	<b>Art.5803</b> COL requirement m² 2.22 H 140 cm. COM Meterage m 1.1	
<b>Product already assembled</b> <b>Art.5803</b> 1 pz = 1  - kg 8,15/ m³ 0,326 2 pz = 1  - kg 13,65/ m³ 0,383 4 pz = 1  - kg 24,5/ m³ 0,476		
<b>FIRE RETARDANT TEST</b> Classe 1IM Omologazione Italia Remix 3 Kvadrat.		

Frame Base



# Mixu

Design in collaboration with Gensler, 2021

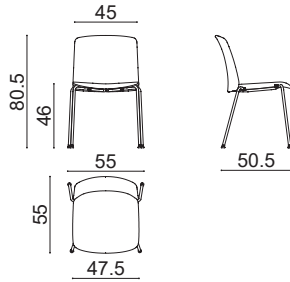

Chair on a four-legged base in chromed or powder-coated steel. Seat upholstered with Elmosoft leather or Valencia coated fabric. Backrest upholstered with an alternative material than the one used for the seat, chosen from the Arper portfolio or customer's own material.

Stackability:  
(should the weight exceed 25 kilos a handling tool must be used).

- with stacking pad, without tools up to 4 units
- with stacking pad, with trolley up to 4 units

Accessories:  
Single trolley Art. 0500  
Stacking protection pad Art. 5830

SEK ART. 5804	A	B COM	C COL	D	E	F	G	H	I	J	K	L	M	ES
SEAT: LEATHER ELMOSOFT	6963	7156	7349	7542	7735	7928	8121	8314	8507	8700	8893	9086	9279	8029
SEAT: COATED FABRIC VALENCIA	5012	5205	5398	5591	5784	5977	6170	6363	6556	6749	6942	7135	7328	
Product already assembled	+ 181													

SHIPMENT DETAILS	TECHNICAL SPECIFICATIONS	RESISTANCE TEST
<b>Art.5804</b> 1 pz = 1  - kg 7,7/ m³ 0,169 2 pz = 1  - kg 14,53/ m³ 0,234 4 pz = 1  - kg 25,53/ m³ 0,234 <b>KD</b>	<b>Art.5804</b> COL requirement m² 2.28 H 140 cm. COM Meterage m 1.18	
<b>Product already assembled</b>		
<b>Art.5804</b> 1 pz = 1  - kg 8,15/ m³ 0,326 2 pz = 1  - kg 13,65/ m³ 0,383 4 pz = 1  - kg 24,5/ m³ 0,476		
<b>FIRE RETARDANT TEST</b>		

Frame Base



# Mixu

Design in collaboration with Gensler, 2021

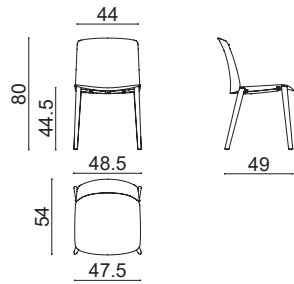

Chair on a four-legged base in solid oak (natural or stained black finish). Polypropylene seat made with 80% recycled materials and polypropylene backrest, both available in five colours. The finishes of the base, seat and backrest can be freely combined.

<b>SEK ART. 5805</b>	PM	
WOOD LEGS	4480	
Product already assembled	+ 181	
<b>SHIPMENT DETAILS</b>	<b>TECHNICAL SPECIFICATIONS</b>	<b>RESISTANCE TEST</b>
<b>Art.5805</b> 1 pz = 1  - kg 7,7/ m³ 0,169 2 pz = 1  - kg 14,53/ m³ 0,234 4 pz = 1  - kg 25,53/ m³ 0,234 		<ul style="list-style-type: none"> <li>• EN 1728:2012 - EN 16139:2013 6.15</li> <li>• EN 1728:2012 - EN 16139:2013 6.17</li> <li>• EN 1728:2012 - EN 16139:2013 6.24</li> <li>• EN 1728:2012 - EN 16139:2013 4.1-4.2</li> <li>• EN 1728:2012 - EN 16139:2013 6.5</li> <li>• EN 1022:2018 7.3</li> </ul>
<b>Product already assembled</b> <b>Art.5805</b> 1 pz = 1  - kg 8,15/ m³ 0,326 2 pz = 1  - kg 13,15/ m³ 0,371		<ul style="list-style-type: none"> <li>• EN 1728:2012 - EN 16139:2013 6.16</li> <li>• EN 1728:2012 - EN 16139:2013 6.18</li> <li>• EN 1728:2012 - EN 16139:2013 6.25</li> <li>• EN 1728:2012 - EN 16139:2013 6.4</li> <li>• EN 1728:2012 - EN 16139:2013 6.8</li> </ul>
<b>FIRE RETARDANT TEST</b>		

Frame Base

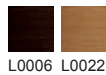

L0006 L0022

Seat



PM00001 PM00002 PM00003 PM00004 PM00005

Backrest



PM00001 PM00002 PM00003 PM00004 PM00005



# Mixu

Design in collaboration with Gensler, 2021

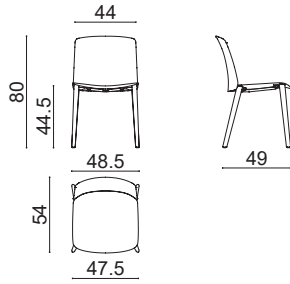

Chair on a four-legged base in solid oak (natural or stained black finish). Seat made of plywood with a reconstituted oak finish (natural or stained black) and polypropylene backrest available in five colours. The finishes of the base, seat and backrest can be freely combined.

<b>SEK ART. 5806</b>	PM	
WOOD LEGS	5421	
Product already assembled	+ 181	
<b>SHIPMENT DETAILS</b>	<b>TECHNICAL SPECIFICATIONS</b>	<b>RESISTANCE TEST</b>
<b>Art.5806</b> 1 pz = 1  - kg 7,7/ m³ 0,169 2 pz = 1  - kg 14,53/ m³ 0,234 4 pz = 1  - kg 25,53/ m³ 0,234 <b>KD</b>		
<b>Product already assembled</b>		
<b>Art.5806</b> 1 pz = 1  - kg 8,15/ m³ 0,326 2 pz = 1  - kg 13,15/ m³ 0,371		
<b>FIRE RETARDANT TEST</b>		

Frame Base

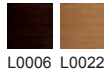

L0006 L0022

Seat



L0006 L0022

Backrest



PM00001 PM00002 PM00003 PM00004 PM00005



# Mixu

Design in collaboration with Gensler, 2021

Chair on a four-legged base in solid oak (natural or stained black finish). Seat upholstered in fabric, leather, coated fabric or customer's own material and polypropylene backrest available in five colours.

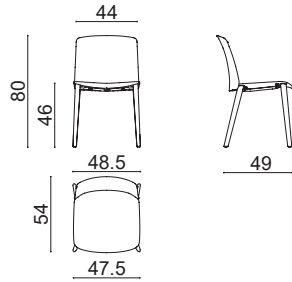

SEK ART. 5807	A	B COM	C COL	D	E	F	G	H	I	J	K	L	M	ES
WOOD LEGS	5421	5592	5763	5934	6105	6276	6447	6618	6789	6960	7131	7302	7473	8063
Product already assembled	+ 181													
SHIPMENT DETAILS	TECHNICAL SPECIFICATIONS				RESISTANCE TEST									
<b>Art.5807</b> 1 pz = 1  - kg 7,7/ m³ 0,169 2 pz = 1  - kg 14,53/ m³ 0,234 4 pz = 1  - kg 25,53/ m³ 0,234 	<b>Art.5807</b> COL requirement m² 1.08 H 140 cm. COM Meterage m 0.616													
<b>Product already assembled</b> <b>Art.5807</b> 1 pz = 1  - kg 8,15/ m³ 0,326 2 pz = 1  - kg 13,15/ m³ 0,371														
FIRE RETARDANT TEST														

Frame Base

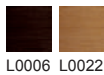

Backrest





# Mixu

Design in collaboration with Gensler, 2021

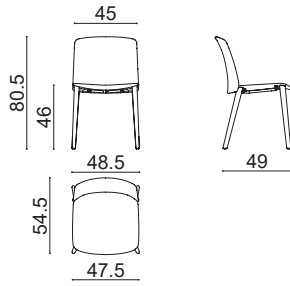

Chair on a four-legged base in solid oak (natural or stained black finish). Seat and backrest upholstered with fabric, leather, coated fabric or customer's own material. On request and with an additional charge, the seat and backrest can be made using different shades of the same cover.

SEK ART. 5808	A	B COM	C COL	D	E	F	G	H	I	J	K	L	M	ES
WOOD LEGS	6249	6533	6817	7101	7385	7669	7953	8237	8521	8805	9089	9373	9657	10785
	A	B COM	C COL	D	E	F	G	H	I	J	K	L	M	ES
Upholstery: two colors	+ 45	+ 80	+ 115	+ 150	+ 185	+ 220	+ 255	+ 290	+ 325	+ 360	+ 395	+ 430	+ 465	+ 612
Product already assembled	+ 181													

SHIPMENT DETAILS	TECHNICAL SPECIFICATIONS	RESISTANCE TEST
<b>Art.5808</b> 1 pz = 1  - kg 7,7/ m³ 0,169 2 pz = 1  - kg 14,53/ m³ 0,234 4 pz = 1  - kg 25,53/ m³ 0,234 <b>KD</b>	<b>Art.5808</b> COL requirement m² 2.22 H 140 cm. COM Meterage m 1.1	
<b>Product already assembled</b> <b>Art.5808</b> 1 pz = 1  - kg 8,15/ m³ 0,326 2 pz = 1  - kg 13,15/ m³ 0,371		
<b>FIRE RETARDANT TEST</b> Classe 1IM Omologazione Italia Remix 3 Kvadrat.		

Frame Base



# Mixu

Design in collaboration with Gensler, 2021

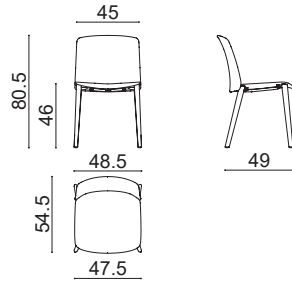

Chair on a four-legged base in solid oak (natural or stained black finish). Seat upholstered with Elmosoft leather or Valencia coated fabric. Backrest upholstered with an alternative material than the one used for the seat, chosen from the Arper portfolio or customer's own material.

SEK ART. 5809	A	B COM	C COL	D	E	F	G	H	I	J	K	L	M	ES
SEAT: LEATHER ELMOFOFT	8369	8562	8755	8948	9141	9334	9527	9720	9913	10106	10299	10492	10685	9447
SEAT: COATED FABRIC VALENCIA	6430	6623	6816	7009	7202	7395	7588	7781	7974	8167	8360	8553	8746	
Product already assembled	+ 181													

SHIPMENT DETAILS	TECHNICAL SPECIFICATIONS	RESISTANCE TEST
<b>Art.5809</b> 1 pz = 1  - kg 7,7/ m³ 0,169 2 pz = 1  - kg 14,53/ m³ 0,234 4 pz = 1  - kg 25,53/ m³ 0,234 <b>KD</b>	<b>Art.5809</b> COL requirement m² 2,28 H 140 cm. COM Meterage m 1.18	
<b>Product already assembled</b>		
<b>Art.5809</b> 1 pz = 1  - kg 8,15/ m³ 0,326 2 pz = 1  - kg 13,15/ m³ 0,371		
<b>FIRE RETARDANT TEST</b>		

Frame Base



# Mixu Counter Stool

Design in collaboration with Gensler, 2021

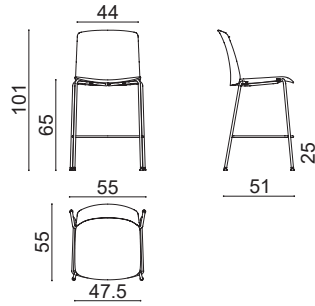

Stool on a four-legged base in chromed or powder-coated steel. Polypropylene seat made with 80% recycled materials and polypropylene backrest, both available in five colours. The finishes of the base, seat and backrest can be freely combined. Seat height 65 cm.

Accessories:  
Single trolley Art. 0500

Stackability:  
(should the weight exceed 25 kilos a handling tool must be used).  
– without tools up to 4 units  
– with trolley up to 4 units

<b>SEK ART. 5810</b>	PM	
CHROMED / POWDERCOATED	3890	
Product already assembled	+ 239	
<b>SHIPMENT DETAILS</b>	<b>TECHNICAL SPECIFICATIONS</b>	<b>RESISTANCE TEST</b>
<b>Art.5810</b> 1 pz = 1  - kg 9,6/ m³ 0,262 2 pz = 1  - kg 16,1/ m³ 0,262 4 pz = 1  - kg 29,8/ m³ 0,328 		
<b>Product already assembled</b>		
<b>Art.5810</b> 1 pz = 1  - kg 9,65/ m³ 0,398 2 pz = 1  - kg 16,3/ m³ 0,435 4 pz = 1  - kg 29,3/ m³ 0,468		
<b>FIRE RETARDANT TEST</b>		

## Frame Base



## Seat



## Backrest



# Mixu Bar Stool

Design in collaboration with Gensler, 2021

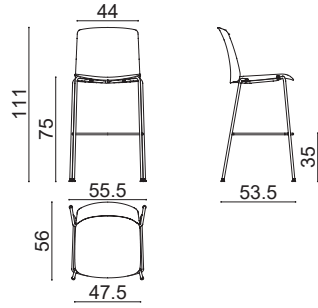

Stool on a four-legged base in chromed or powder-coated steel. Polypropylene seat made with 80% recycled materials and polypropylene backrest, both available in five colours. The finishes of the base, seat and backrest can be freely combined. Seat height 75 cm.

Accessories:  
Single trolley Art. 0500

Stackability:  
(should the weight exceed 25 kilos a handling tool must be used).  
– without trolley up to 4 units  
– with trolley up to 4 units

<b>SEK ART. 5820</b>	PM	
CHROMED / POWDERCOATED	3890	
Product already assembled	+ 239	
<b>SHIPMENT DETAILS</b>	<b>TECHNICAL SPECIFICATIONS</b>	<b>RESISTANCE TEST</b>
<b>Art.5820</b> 1 pz = 1  - kg 10,1/ m³ 0,29 2 pz = 1  - kg 17,8/ m³ 0,37 4 pz = 1  - kg 31,8/ m³ 0,37 		<ul style="list-style-type: none"> <li>• EN 1728:2012 - EN 16139:2013 6.15</li> <li>• EN 1728:2012 - EN 16139:2013 6.17</li> <li>• EN 1728:2012 - EN 16139:2013 6.24</li> <li>• EN 1728:2012 - EN 16139:2013 4.1-4.2</li> <li>• EN 1728:2012 - EN 16139:2013 6.5</li> <li>• EN 1022:2018 7.3</li> </ul>
<b>Product already assembled</b> <b>Art.5820</b> 1 pz = 1  - kg 10,15/ m³ 0,435 2 pz = 1  - kg 17,3/ m³ 0,468 4 pz = 1  - kg 31,3/ m³ 0,495		<ul style="list-style-type: none"> <li>• EN 1728:2012 - EN 16139:2013 6.16</li> <li>• EN 1728:2012 - EN 16139:2013 6.18</li> <li>• EN 1728:2012 - EN 16139:2013 6.25</li> <li>• EN 1728:2012 - EN 16139:2013 6.2</li> <li>• EN 1728:2012 - EN 16139:2013 6.4</li> <li>• EN 1728:2012 - EN 16139:2013 6.28</li> </ul>
<b>FIRE RETARDANT TEST</b>		

## Frame Base



## Seat



## Backrest



# Mixu Counter Stool

Design in collaboration with Gensler, 2021

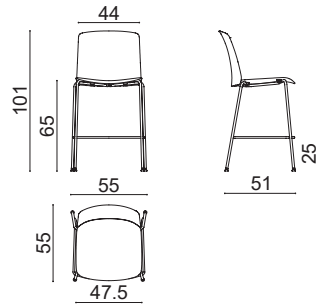

Stool on a four-legged base in chromed or powder-coated steel. Seat made of plywood with a reconstituted oak finish (natural or stained black) and polypropylene backrest available in five colours. The finishes of the base, seat and backrest can be freely combined. Seat height 65 cm.

Accessories:  
Single trolley Art. 0500

Stackability:  
(should the weight exceed 25 kilos a handling tool must be used).  
– without tools up to 4 units  
– with trolley up to 4 units

<b>SEK ART. 5811</b>	PM	
CHROMED / POWDERCOATED	4831	
Product already assembled	+ 239	
<b>SHIPMENT DETAILS</b>	<b>TECHNICAL SPECIFICATIONS</b>	<b>RESISTANCE TEST</b>
<b>Art.5811</b> 1 pz = 1  - kg 9,6/ m³ 0,262 2 pz = 1  - kg 16,1/ m³ 0,262 4 pz = 1  - kg 29,8/ m³ 0,328 		
<b>Product already assembled</b>		
<b>Art.5811</b> 1 pz = 1  - kg 9,65/ m³ 0,398 2 pz = 1  - kg 16,3/ m³ 0,435 4 pz = 1  - kg 29,3/ m³ 0,468		
<b>FIRE RETARDANT TEST</b>		

## Frame Base

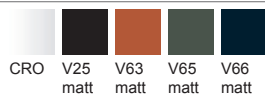

## Seat



## Backrest



# Mixu Bar Stool

Design in collaboration with Gensler, 2021

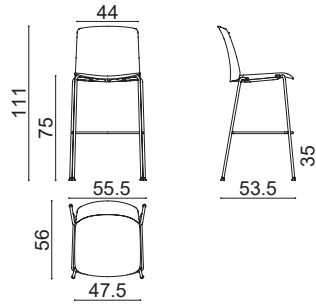

Stool on a four-legged base in chromed or powder-coated steel. Seat made of plywood with a reconstituted oak finish (natural or stained black) and polypropylene backrest available in five colours. The finishes of the base, seat and backrest can be freely combined. Seat height 75 cm.

Accessories:  
Single trolley Art. 0500

Stackability:  
(should the weight exceed 25 kilos a handling tool must be used).  
– without tools up to 4 units  
– with trolley up to 4 units

<b>SEK ART. 5821</b>	PM	
CHROMED / POWDERCOATED	4831	
Product already assembled	+ 239	
<b>SHIPMENT DETAILS</b>	<b>TECHNICAL SPECIFICATIONS</b>	<b>RESISTANCE TEST</b>
<b>Art.5821</b> 1 pz = 1  - kg 10,1/ m³ 0,29 2 pz = 1  - kg 17,8/ m³ 0,37 4 pz = 1  - kg 31,8/ m³ 0,37 		
<b>Product already assembled</b>		
<b>Art.5821</b> 1 pz = 1  - kg 10,15/ m³ 0,435 2 pz = 1  - kg 17,3/ m³ 0,468 4 pz = 1  - kg 31,3/ m³ 0,495		
<b>FIRE RETARDANT TEST</b>		

## Frame Base



## Seat



## Backrest



# Mixu Counter Stool

Design in collaboration with Gensler, 2021

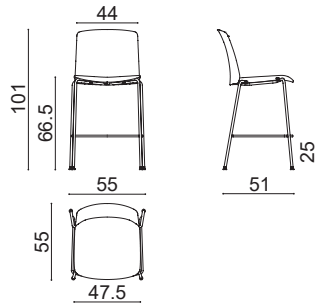

Stool on a four-legged base in chromed or powder-coated steel. Seat upholstered in fabric, leather, coated fabric or customer's own material and polypropylene backrest available in five colours. Seat height 66.5 cm.

Accessories:  
Single trolley Art. 0500  
Stacking protection pad Art. 5830

Stackability:  
(should the weight exceed 25 kilos a handling tool must be used).  
– with stacking pad, without tools up to 4 units  
– with stacking pad, with trolley up to 4 units

SEK ART. 5812	A	B COM	C COL	D	E	F	G	H	I	J	K	L	M	ES
CHROMED / POWDERCOATED	4831	5002	5173	5344	5515	5686	5857	6028	6199	6370	6541	6712	6883	7474
Product already assembled	+ 239													

SHIPMENT DETAILS	TECHNICAL SPECIFICATIONS	RESISTANCE TEST
<b>Art.5812</b> 1 pz = 1  - kg 9,6/ m³ 0,262 2 pz = 1  - kg 16,1/ m³ 0,262 4 pz = 1  - kg 29,8/ m³ 0,328 <b>KD</b> <b>Product already assembled</b> <b>Art.5812</b> 1 pz = 1  - kg 9,65/ m³ 0,398 2 pz = 1  - kg 16,3/ m³ 0,435 4 pz = 1  - kg 29,3/ m³ 0,468	<b>Art.5812</b> COL requirement m² 1.08 H 140 cm. COM Meterage m 0.616	
<b>FIRE RETARDANT TEST</b>		

## Frame Base



## Backrest



# Mixu Bar Stool

Design in collaboration with Gensler, 2021

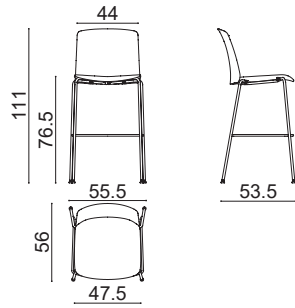

Stool on a four-legged base in chromed or powder-coated steel. Seat upholstered in fabric, leather, coated fabric or customer's own material and polypropylene backrest available in five colours. Seat height 76.5 cm.

Accessories:  
Single trolley Art. 0500  
Stacking protection pad Art. 5830

Stackability:  
(should the weight exceed 25 kilos a handling tool must be used).  
– with stacking pad, without tools up to 4 units  
– with stacking pad, with trolley up to 4 units

SEK ART. 5822	A	B COM	C COL	D	E	F	G	H	I	J	K	L	M	ES
CHROMED / POWDERCOATED	4831	5002	5173	5344	5515	5686	5857	6028	6199	6370	6541	6712	6883	7474
Product already assembled	+ 239													

SHIPMENT DETAILS	TECHNICAL SPECIFICATIONS	RESISTANCE TEST
<b>Art.5822</b> 1 pz = 1  - kg 10,1/ m³ 0,29 2 pz = 1  - kg 17,8/ m³ 0,37 4 pz = 1  - kg 31,8/ m³ 0,37 KD	<b>Art.5822</b> COL requirement m² 1.08 H 140 cm. COM Meterage m 0.616	
<b>Product already assembled</b> <b>Art.5822</b> 1 pz = 1  - kg 10,15/ m³ 0,435 2 pz = 1  - kg 17,3/ m³ 0,468 4 pz = 1  - kg 31,3/ m³ 0,495		
<b>FIRE RETARDANT TEST</b>		

## Frame Base



## Backrest





# Mixu Counter Stool

Design in collaboration with Gensler, 2021

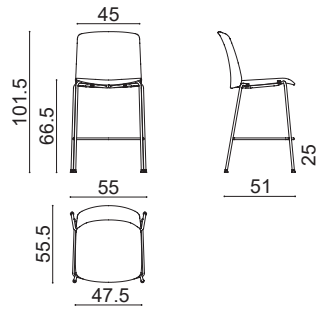

Stool on a four-legged base in chromed or powder-coated steel. Seat and backrest upholstered with fabric, leather, coated fabric or customer's own material. On request and with an additional charge, the seat and backrest can be made using different shades of the same cover. Seat height 66.5 cm.

Stackability:  
(should the weight exceed 25 kilos a handling tool must be used).

- with stacking pad, without tools up to 4 units
- with stacking pad, with trolley up to 4 units

Accessories:  
Single trolley Art. 0500  
Stacking protection pad Art. 5830

SEK ART. 5813	A	B COM	C COL	D	E	F	G	H	I	J	K	L	M	ES
CHROMED / POWDERCOATED	5659	5943	6227	6511	6795	7079	7363	7647	7931	8215	8499	8783	9067	10195
	A	B COM	C COL	D	E	F	G	H	I	J	K	L	M	ES
Upholstery: two colors	+ 45	+ 80	+ 115	+ 150	+ 185	+ 220	+ 255	+ 290	+ 325	+ 360	+ 395	+ 430	+ 465	+ 612
Product already assembled	+ 239													

SHIPMENT DETAILS	TECHNICAL SPECIFICATIONS	RESISTANCE TEST
<b>Art.5813</b> 1 pz = 1  - kg 9,6/ m³ 0,262 2 pz = 1  - kg 16,1/ m³ 0,262 4 pz = 1  - kg 29,8/ m³ 0,328 <b>KD</b>	<b>Art.5813</b> COL requirement m² 2.22 H 140 cm. COM Meterage m 1.1	
<b>Product already assembled</b> <b>Art.5813</b> 1 pz = 1  - kg 9,65/ m³ 0,398 2 pz = 1  - kg 16,3/ m³ 0,435 4 pz = 1  - kg 29,3/ m³ 0,468		
<b>FIRE RETARDANT TEST</b> Classe 1IM Omologazione Italia Remix 3 Kvadrat.		

Frame Base



# Mixu Bar Stool

Design in collaboration with Gensler, 2021

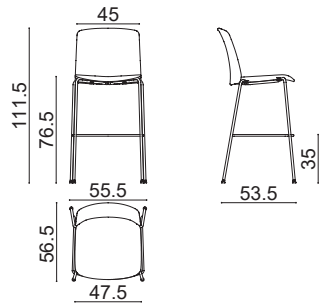

Stool on a four-legged base in chromed or powder-coated steel. Seat and backrest upholstered with fabric, leather, coated fabric or customer's own material. On request and with an additional charge, the seat and backrest can be made using different shades of the same cover. Seat height 76.5 cm.

Stackability:  
(should the weight exceed 25 kilos a handling tool must be used).

- with stacking pad, without tools up to 4 units
- with stacking pad, with trolley up to 4 units

Accessories:  
Single trolley Art. 0500  
Stacking protection pad Art. 5830

SEK ART. 5823	A	B COM	C COL	D	E	F	G	H	I	J	K	L	M	ES
CHROMED / POWDERCOATED	5659	5943	6227	6511	6795	7079	7363	7647	7931	8215	8499	8783	9067	10195
	A	B COM	C COL	D	E	F	G	H	I	J	K	L	M	ES
Upholstery: two colors	+ 45	+ 80	+ 115	+ 150	+ 185	+ 220	+ 255	+ 290	+ 325	+ 360	+ 395	+ 430	+ 465	+ 612
Product already assembled	+ 239													

SHIPMENT DETAILS	TECHNICAL SPECIFICATIONS	RESISTANCE TEST
<b>Art.5823</b> 1 pz = 1  - kg 10,1/ m³ 0,29 2 pz = 1  - kg 17,8/ m³ 0,37 4 pz = 1  - kg 31,8/ m³ 0,37 <b>KD</b> <b>Product already assembled</b> <b>Art.5823</b> 1 pz = 1  - kg 10,15/ m³ 0,435 2 pz = 1  - kg 17,3/ m³ 0,468 4 pz = 1  - kg 31,3/ m³ 0,495	<b>Art.5823</b> COL requirement m² 2.22 H 140 cm. COM Meterage m 1.1	
<b>FIRE RETARDANT TEST</b> Classe 1IM Omologazione Italia Remix 3 Kvadrat.		

Frame Base



# Mixu Counter Stool

Design in collaboration with Gensler, 2021

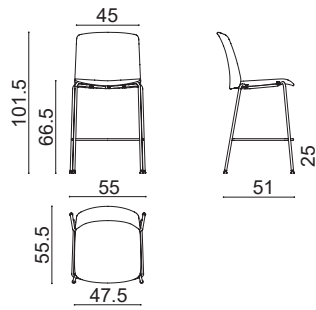

Stool on a four-legged base in chromed or powder-coated steel. Seat upholstered with Elmosoft leather or Valencia coated fabric. Backrest upholstered with an alternative material than the one used for the seat, chosen from the Arper portfolio or customer's own material. Seat height 66.5 cm.

Stackability:  
(should the weight exceed 25 kilos a handling tool must be used).

- with stacking pad, without tools up to 4 units
- with stacking pad, with trolley up to 4 units

Accessories:  
Single trolley Art. 0500  
Stacking protection pad Art. 5830

SEK ART. 5814	A	B COM	C COL	D	E	F	G	H	I	J	K	L	M	ES
SEAT: LEATHER ELMOSOFT	7779	7972	8165	8358	8551	8744	8937	9130	9323	9516	9709	9902	10095	8857
SEAT: COATED FABRIC VALENCIA	5841	6034	6227	6420	6613	6806	6999	7192	7385	7578	7771	7964	8157	
Product already assembled	+ 239													

SHIPMENT DETAILS	TECHNICAL SPECIFICATIONS	RESISTANCE TEST
<b>Art.5814</b> 1 pz = 1  - kg 9,6/ m³ 0,262 2 pz = 1  - kg 16,1/ m³ 0,262 4 pz = 1  - kg 29,8/ m³ 0,328 <b>KD</b>	<b>Art.5814</b> COL requirement m² 2.28 H 140 cm. COM Meterage m 1.18	
<b>Product already assembled</b>		
<b>Art.5814</b> 1 pz = 1  - kg 9,65/ m³ 0,398 2 pz = 1  - kg 16,3/ m³ 0,435 4 pz = 1  - kg 29,3/ m³ 0,468		
<b>FIRE RETARDANT TEST</b>		

Frame Base



# Mixu Bar Stool

Design in collaboration with Gensler, 2021

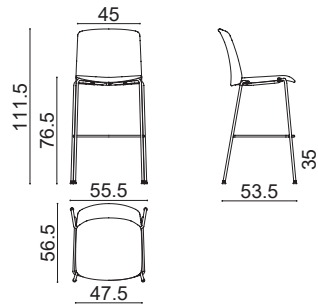

Stool on a four-legged base in chromed or powder-coated steel. Seat upholstered with Elmosoft leather or Valencia coated fabric. Backrest upholstered with an alternative material than the one used for the seat, chosen from the Arper portfolio or customer's own material. Seat height 76.5 cm.

Stackability:  
(should the weight exceed 25 kilos a handling tool must be used).

- with stacking pad, without tools up to 4 units
- with stacking pad, with trolley up to 4 units

Accessories:  
Single trolley Art. 0500  
Stacking protection pad Art. 5830

SEK ART. 5824	A	B COM	C COL	D	E	F	G	H	I	J	K	L	M	ES
SEAT: LEATHER ELMOFOFT	7779	7972	8165	8358	8551	8744	8937	9130	9323	9516	9709	9902	10095	8857
SEAT: COATED FABRIC VALENCIA	5841	6034	6227	6420	6613	6806	6999	7192	7385	7578	7771	7964	8157	
Product already assembled	+ 239													

SHIPMENT DETAILS	TECHNICAL SPECIFICATIONS	RESISTANCE TEST
<b>Art.5824</b> 1 pz = 1  - kg 10,1/ m³ 0,29 2 pz = 1  - kg 17,8/ m³ 0,37 4 pz = 1  - kg 31,8/ m³ 0,37 KD	<b>Art.5824</b> COL requirement m² 2.28 H 140 cm. COM Meterage m 1.18	
<b>Product already assembled</b>		
<b>Art.5824</b> 1 pz = 1  - kg 10,15/ m³ 0,435 2 pz = 1  - kg 17,3/ m³ 0,468 4 pz = 1  - kg 31,3/ m³ 0,495		
<b>FIRE RETARDANT TEST</b>		

Frame Base



# Mixu Counter Stool

Design in collaboration with Gensler, 2021

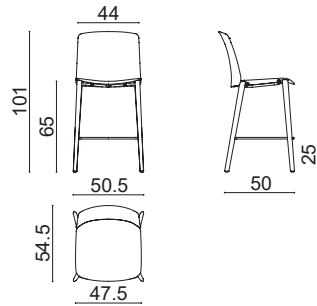

Stool on a four-legged base in solid oak (natural or stained black finish). Polypropylene seat made with 80% recycled materials and polypropylene backrest, both available in five colours. The finishes of the base, seat and backrest can be freely combined. Seat height 65 cm.

<b>SEK ART. 5815</b>	PM	
WOOD LEGS	7076	
Product already assembled	+ 239	
<b>SHIPMENT DETAILS</b>	<b>TECHNICAL SPECIFICATIONS</b>	<b>RESISTANCE TEST</b>
<b>Art.5815</b> 1 pz = 1  - kg 10,3/ m³ 0,262 2 pz = 1  - kg 16,8/ m³ 0,262 4 pz = 1  - kg 30,5/ m³ 0,328 		
<b>Product already assembled</b>		
<b>Art.5815</b> 1 pz = 1  - kg 9,65/ m³ 0,398		
<b>FIRE RETARDANT TEST</b>		

Frame Base

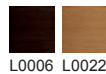

Seat



Backrest



# Mixu Bar Stool

Design in collaboration with Gensler, 2021

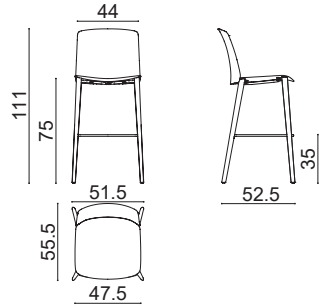

Stool on a four-legged base in solid oak (natural or stained black finish). Polypropylene seat made with 80% recycled materials and polypropylene backrest, both available in five colours. The finishes of the base, seat and backrest can be freely combined. Seat height 75 cm.

<b>SEK ART. 5825</b>	PM	
WOOD LEGS	7076	
Product already assembled	+ 239	
<b>SHIPMENT DETAILS</b>	<b>TECHNICAL SPECIFICATIONS</b>	<b>RESISTANCE TEST</b>
<b>Art.5825</b> 1 pz = 1  - kg 10,8/ m³ 0,29 2 pz = 1  - kg 18,5/ m³ 0,37 4 pz = 1  - kg 32,5/ m³ 0,37 		<ul style="list-style-type: none"> <li>• EN 1728:2012 - EN 16139:2013 6.15</li> <li>• EN 1728:2012 - EN 16139:2013 6.17</li> <li>• EN 1728:2012 - EN 16139:2013 6.21</li> <li>• EN 1728:2012 - EN 16139:2013 6.25</li> <li>• EN 1728:2012 - EN 16139:2013 6.4</li> <li>• EN 1728:2012 - EN 16139:2013 6.8</li> <li>• EN 1022:2018 7.3</li> </ul>
<b>Product already assembled</b> <b>Art.5825</b> 1 pz = 1  - kg 10,15/ m³ 0,435		<ul style="list-style-type: none"> <li>• EN 1728:2012 - EN 16139:2013 6.16</li> <li>• EN 1728:2012 - EN 16139:2013 6.18</li> <li>• EN 1728:2012 - EN 16139:2013 6.24</li> <li>• EN 1728:2012 - EN 16139:2013 4.1-4.2</li> <li>• EN 1728:2012 - EN 16139:2013 6.5</li> <li>• EN 1728:2012 - EN 16139:2013 6.28</li> </ul>
<b>FIRE RETARDANT TEST</b>		

Frame Base

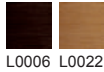

L0006 L0022

Seat



PM00001 PM00002 PM00003 PM00004 PM00005

Backrest



PM00001 PM00002 PM00003 PM00004 PM00005



# Mixu Counter Stool

Design in collaboration with Gensler, 2021

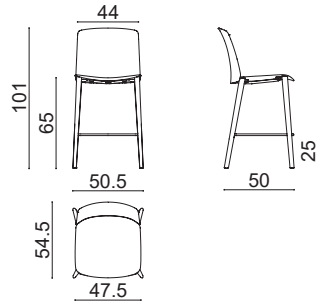

Stool on a four-legged base in solid oak (natural or stained black finish). Seat made of plywood with a reconstituted oak finish (natural or stained black) and polypropylene backrest available in five colours. The finishes of the base, seat and backrest can be freely combined. Seat height 65 cm.

<b>SEK ART. 5816</b>	PM	
WOOD LEGS	8018	
Product already assembled	+ 239	
<b>SHIPMENT DETAILS</b>	<b>TECHNICAL SPECIFICATIONS</b>	<b>RESISTANCE TEST</b>
<b>Art.5816</b> 1 pz = 1  - kg 10,3/ m³ 0,262 2 pz = 1  - kg 16,8/ m³ 0,262 4 pz = 1  - kg 30,5/ m³ 0,328 		
<b>Product already assembled</b>		
<b>Art.5816</b> 1 pz = 1  - kg 9,65/ m³ 0,398		
<b>FIRE RETARDANT TEST</b>		

Frame Base

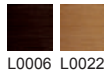

L0006 L0022

Seat



L0006 L0022

Backrest



PM00001 PM00002 PM00003 PM00004 PM00005



# Mixu Bar Stool

Design in collaboration with Gensler, 2021

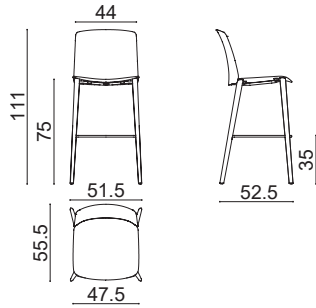

Stool on a four-legged base in solid oak (natural or stained black finish). Seat made of plywood with a reconstituted oak finish (natural or stained black) and polypropylene backrest available in five colours. The finishes of the base, seat and backrest can be freely combined. Seat height 75 cm.

<b>SEK ART. 5826</b>	PM	
WOOD LEGS	8018	
Product already assembled	+ 239	
<b>SHIPMENT DETAILS</b>	<b>TECHNICAL SPECIFICATIONS</b>	<b>RESISTANCE TEST</b>
<b>Art.5826</b> 1 pz = 1  - kg 10,8/ m³ 0,29 2 pz = 1  - kg 18,5/ m³ 0,37 4 pz = 1  - kg 32,5/ m³ 0,37 		
<b>Product already assembled</b> <b>Art.5826</b> 1 pz = 1  - kg 10,15/ m³ 0,435		
<b>FIRE RETARDANT TEST</b>		

Frame Base

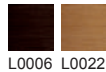

L0006 L0022

Seat



L0006 L0022

Backrest



PM00001 PM00002 PM00003 PM00004 PM00005





# Mixu Counter Stool

Design in collaboration with Gensler, 2021

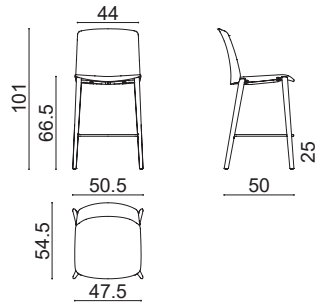

Stool on a four-legged base in solid oak (natural or stained black finish). Seat upholstered in fabric, leather, coated fabric or customer's own material and polypropylene backrest available in five colours. Seat height 66.5 cm.

SEK ART. 5817	A	B COM	C COL	D	E	F	G	H	I	J	K	L	M	ES
WOOD LEGS	8018	8189	8360	8531	8702	8873	9044	9215	9386	9557	9728	9899	10070	10660
Product already assembled	+ 239													
SHIPMENT DETAILS	TECHNICAL SPECIFICATIONS				RESISTANCE TEST									
<b>Art.5817</b> 1 pz = 1  - kg 10,3/ m³ 0,262 2 pz = 1  - kg 16,8/ m³ 0,262 4 pz = 1  - kg 30,5/ m³ 0,328 <b>KD</b>	<b>Art.5817</b> COL requirement m² 1.08 H 140 cm. COM Meterage m 0.616													
Product already assembled														
<b>Art.5817</b> 1 pz = 1  - kg 9,65/ m³ 0,398														
FIRE RETARDANT TEST														

Frame Base

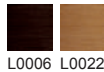

Backrest



# Mixu Bar Stool

Design in collaboration with Gensler, 2021

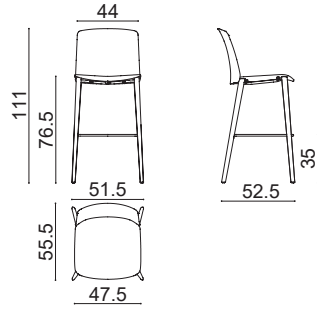

Stool on a four-legged base in solid oak (natural or stained black finish). Seat upholstered in fabric, leather, coated fabric or customer's own material and polypropylene backrest available in five colours. Seat height 76.5 cm.

SEK ART. 5827	A	B COM	C COL	D	E	F	G	H	I	J	K	L	M	ES
WOOD LEGS	8018	8189	8360	8531	8702	8873	9044	9215	9386	9557	9728	9899	10070	10660
Product already assembled	+ 239													
SHIPMENT DETAILS	TECHNICAL SPECIFICATIONS				RESISTANCE TEST									
<b>Art.5827</b> 1 pz = 1  - kg 10,8/ m³ 0,29 2 pz = 1  - kg 18,5/ m³ 0,37 4 pz = 1  - kg 32,5/ m³ 0,37 KD	<b>Art.5827</b> COL requirement m² 1.08 H 140 cm. COM Meterage m 0.616													
Product already assembled														
<b>Art.5827</b> 1 pz = 1  - kg 10,15/ m³ 0,435														
FIRE RETARDANT TEST														

Frame Base

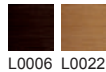

Backrest



# Mixu Counter Stool

Design in collaboration with Gensler, 2021

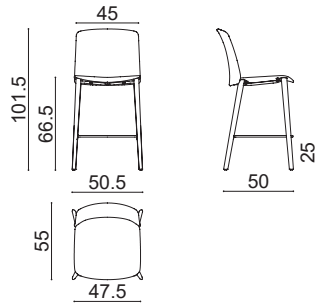

Stool on a four-legged base in solid oak (natural or stained black finish). Seat and backrest upholstered with fabric, leather, coated fabric or customer's own material. On request and with an additional charge, the seat and backrest can be made using different shades of the same cover. Seat height 26 1/4".

SEK ART. 5818	A	B COM	C COL	D	E	F	G	H	I	J	K	L	M	ES
WOOD LEGS	8845	9129	9413	9697	9981	10265	10549	10833	11117	11401	11685	11969	12253	13370
	A	B COM	C COL	D	E	F	G	H	I	J	K	L	M	ES
Upholstery: two colors	+ 45	+ 80	+ 115	+ 150	+ 185	+ 220	+ 255	+ 290	+ 325	+ 360	+ 395	+ 430	+ 465	+ 612
Product already assembled	+ 239													

SHIPMENT DETAILS	TECHNICAL SPECIFICATIONS	RESISTANCE TEST
<b>Art.5818</b> 1 pz = 1  - kg 10,3/ m³ 0,262 2 pz = 1  - kg 16,8/ m³ 0,262 4 pz = 1  - kg 30,5/ m³ 0,328 KD	<b>Art.5818</b> COL requirement m² 2.22 H 140 cm. COM Meterage m 1.1	
<b>Product already assembled</b> <b>Art.5818</b> 1 pz = 1  - kg 9,65/ m³ 0,398		
<b>FIRE RETARDANT TEST</b> Classe 1IM Omologazione Italia Remix 3 Kvadrat.		

Frame Base



# Mixu Bar Stool

Design in collaboration with Gensler, 2021

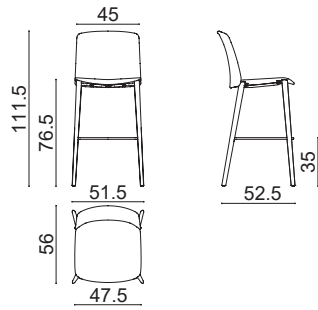

Stool on a four-legged base in solid oak (natural or stained black finish). Seat and backrest upholstered with fabric, leather, coated fabric or customer's own material. On request and with an additional charge, the seat and backrest can be made using different shades of the same cover. Seat height 76.5 cm.

SEK ART. 5828	A	B COM	C COL	D	E	F	G	H	I	J	K	L	M	ES
WOOD LEGS	8845	9129	9413	9697	9981	10265	10549	10833	11117	11401	11685	11969	12253	13370
	A	B COM	C COL	D	E	F	G	H	I	J	K	L	M	ES
Upholstery: two colors	+ 45	+ 80	+ 115	+ 150	+ 185	+ 220	+ 255	+ 290	+ 325	+ 360	+ 395	+ 430	+ 465	+ 612
Product already assembled	+ 239													

SHIPMENT DETAILS	TECHNICAL SPECIFICATIONS	RESISTANCE TEST
<b>Art. 5828</b> 1 pz = 1  - kg 10,8/ m³ 0,29 2 pz = 1  - kg 18,5/ m³ 0,37 4 pz = 1  - kg 32,5/ m³ 0,37 <b>KD</b>	<b>Art. 5828</b> COL requirement m² 2.22 H 140 cm. COM Meterage m 1.1	
<b>Product already assembled</b> <b>Art. 5828</b> 1 pz = 1  - kg 10,15/ m³ 0,435		
<b>FIRE RETARDANT TEST</b> Classe 1IM Omologazione Italia Remix 3 Kvadrat.		

Frame Base



# Mixu Counter Stool

Design in collaboration with Gensler, 2021

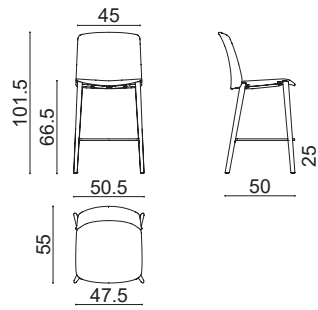

Stool on a four-legged base in solid oak (natural or stained black finish). Seat upholstered with Elmosoft leather or Valencia coated fabric. Backrest upholstered with an alternative material than the one used for the seat, chosen from the Arper portfolio or customer's own material. Seat height 66.5 cm.

SEK ART. 5819	A	B COM	C COL	D	E	F	G	H	I	J	K	L	M	ES
SEAT: LEATHER ELMOSOFT	10966	11159	11352	11545	11738	11931	12124	12317	12510	12703	12896	13089	13282	12043
SEAT: COATED FABRIC VALENCIA	9027	9220	9413	9606	9799	9992	10185	10378	10571	10764	10957	11150	11343	
Product already assembled	+ 239													

SHIPMENT DETAILS	TECHNICAL SPECIFICATIONS	RESISTANCE TEST
<b>Art.5819</b> 1 pz = 1  - kg 10,3/ m³ 0,262 2 pz = 1  - kg 16,8/ m³ 0,262 4 pz = 1  - kg 30,5/ m³ 0,328 <b>KD</b>	<b>Art.5819</b> COL requirement m² 2.28 H 140 cm. COM Meterage m 1.18	
<b>Product already assembled</b>		
<b>Art.5819</b> 1 pz = 1  - kg 9,65/ m³ 0,398		
<b>FIRE RETARDANT TEST</b>		

Frame Base

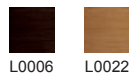

# Mixu Bar Stool

Design in collaboration with Gensler, 2021

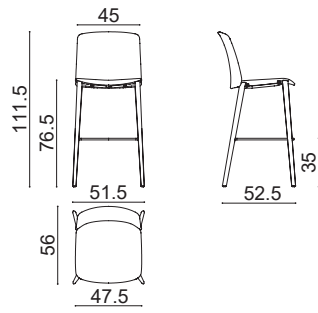

Stool on a four-legged base in solid oak (natural or stained black finish). Seat upholstered with Elmosoft leather or Valencia coated fabric. Backrest upholstered with an alternative material than the one used for the seat, chosen from the Arper portfolio or customer's own material. Seat height 76.5 cm.

SEK ART. 5829	A	B COM	C COL	D	E	F	G	H	I	J	K	L	M	ES
SEAT: LEATHER ELMOFOFT	10966	11159	11352	11545	11738	11931	12124	12317	12510	12703	12896	13089	13282	12043
SEAT: COATED FABRIC VALENCIA	9027	9220	9413	9606	9799	9992	10185	10378	10571	10764	10957	11150	11343	
Product already assembled	+ 239													



SHIPMENT DETAILS	TECHNICAL SPECIFICATIONS	RESISTANCE TEST
<b>Art.5829</b> 1 pz = 1  - kg 10,8/ m³ 0,29 2 pz = 1  - kg 18,5/ m³ 0,37 4 pz = 1  - kg 32,5/ m³ 0,37 KD	<b>Art.5829</b> COL requirement m² 2,28 H 140 cm. COM Meterage m 1.18	
Product already assembled		
<b>Art.5829</b> 1 pz = 1  - kg 10,15/ m³ 0,435		
<b>FIRE RETARDANT TEST</b>		



Frame Base



## Accessories

Design by Lievore Altherr Molina

<p><b>SEK ART. 0500</b></p>  <p>Trolley (Aava 02, Catifa 46, Catifa 53, Juno 02, Mixu)</p> <p>4549</p>	<p><b>SEK ART. 5830</b></p>  <p>Stacking underseat cover for upholstered seat.</p> <p>352</p>
---	--

SHIPMENT DETAILS	TECHNICAL SPECIFICATIONS	RESISTANCE TEST
<p><b>Art. 5830</b></p> <p>1 pz = 1  - kg 1/ m<sup>2</sup> 0,044</p> <p>2 pz = 1  - kg 1,5/ m<sup>2</sup> 0,044</p> <p>4 pz = 1  - kg 2,5/ m<sup>2</sup> 0,044</p>		
<p><b>FIRE RETARDANT TEST</b></p>		



# NORMA

Design by  
Lievore Altherr Molina  
2005





**Collection overview**

---

**Type**



4 legs chair —  
Medium backrest



Stackable 4 legs chair —  
Medium backrest



Counter stool  
4 legs



Bar stool  
4 legs

---

**Base**



4 legs — Upholstered

---

**Armrest types**



BI=  
Aluminum armrest



BR=  
Upholstered aluminum  
armrest

# Norma

Design by Lievore Altherr Molina, 2005

Chair with steel frame and upholstered legs. Polyurethane shell upholstered in hard leather without padding. Integrated armrests in aluminium are available on request (Art. 1702). Backrest height 86 cm.

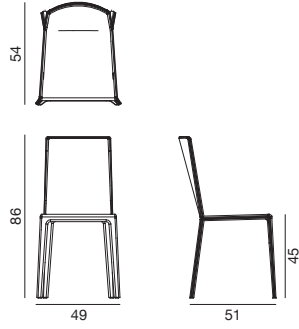

<b>SEK ART. 1702</b>	CT	
	7644	
Armrests BI	+ 1417	
Armrests BR	+ 2179	
<b>SHIPMENT DETAILS</b>	<b>TECHNICAL SPECIFICATIONS</b>	<b>RESISTANCE TEST</b>
<b>Art.1702</b> 1 pz = 1  - kg 10,7/ m³ 0,331 1 pz = 1  - kg 11/ m³ 0,355 2 pz = 1  - kg 19,3/ m³ 0,297		
<b>FIRE RETARDANT TEST</b>		



Armrest



Armrests BI



Armrests BR



# Norma

Design by Lievore Altherr Molina, 2005

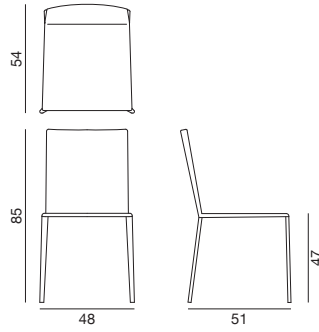

Chair with steel frame and upholstered legs. Polyurethane shell with medium backrest available with upholstery in fabric, coated fabric, leather or customer's material. Integrated armrests in aluminium, also upholstered, are available on request (Art. 1708). Backrest height 85 cm.

SEK ART. 1708	A	B COM	C COL	D	E	F	G	H	I	J	K	L	M	ES
UPHOLSTERED	6013	6239	6465	6691	6917	7143	7369	7595	7821	8047	8273	8499	8725	11276
Armrests BI	+ 1417													
Armrests BR	+ 2179													
SHIPMENT DETAILS	TECHNICAL SPECIFICATIONS				RESISTANCE TEST									
<b>Art.1708</b> 1 pz = 1  - kg 10,7/ m³ 0,279 1 pz = 1  - kg 11/ m³ 0,363 2 pz = 1  - kg 19,3/ m³ 0,405	<b>Art.1708</b> COL requirement m² 1.98 H 140 cm. COM Meterage m 1.21													
FIRE RETARDANT TEST														



Armrest

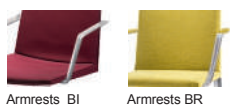

# Norma

Design by Lievore Altherr Molina, 2005

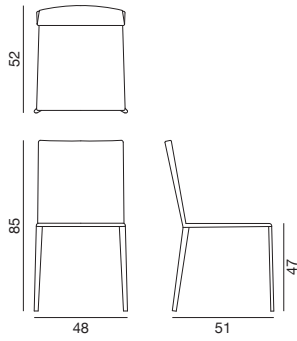

Stackable chair with steel frame and upholstered legs. Polyurethane shell with medium backrest available with upholstery in fabric, coated fabric, leather or customer's material. Integrated armrests in aluminium, also upholstered, are available on request (Art. 1709). Backrest height 85 cm.

– without tools up to 6 units

– with arms: without tools up to 4 units

SEK ART. 1709	A	B COM	C COL	D	E	F	G	H	I	J	K	L	M	ES
UPHOLSTERED	6227	6453	6679	6905	7131	7357	7583	7809	8035	8261	8487	8713	8939	11907
Armrests BI	+ 1417													
Armrests BR	+ 2179													
SHIPMENT DETAILS	TECHNICAL SPECIFICATIONS				RESISTANCE TEST									
<b>Art.1709</b> 1 pz = 1  - kg 10,7/ m³ 0,311 1 pz = 1  - kg 11/ m³ 0,363 2 pz = 1  - kg 19,3/ m³ 0,405	<b>Art.1709</b> COL requirement m² 2.16 H 140 cm. COM Meterage m 1.21 *Classe 1, 2, 11M: fire retardant version available with surcharge and eventual minimum batch													
FIRE RETARDANT TEST														
• FIRE RETARDANT VERSION WITH SURCHARGE * Classe 11M Omologazione Italia Elmosoft. Coated fabric Valencia Spradling.														



Armrest



Armrests BI



Armrests BR



Stackable



# Norma Counter Stool

Design by Lievore Altherr Molina, 2005

Counter stool with steel frame and upholstered legs. Polyurethane shell upholstered in hard leather without padding. Seat height 64 cm.

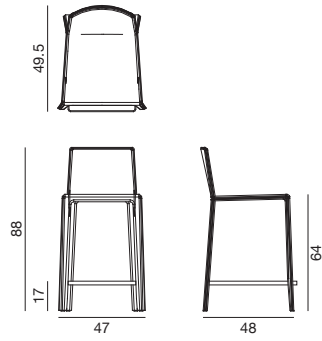

<b>SEK ART. 1714</b>	CT	
	8466	
<b>SHIPMENT DETAILS</b>	<b>TECHNICAL SPECIFICATIONS</b>	<b>RESISTANCE TEST</b>
<b>Art.1714</b> 1 pz = 1  - kg 9,5/ m³ 0,297		
<b>FIRE RETARDANT TEST</b>		



# Norma Counter Stool

Design by Lievore Altherr Molina, 2005

Counter stool with steel frame and upholstered legs. Polyurethane shell upholstered in fabric, leather, coated fabric or customer's material. Seat height 64 cm.

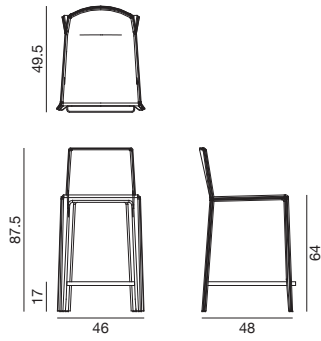

SEK ART. 1719	A	B COM	C COL	D	E	F	G	H	I	J	K	L	M	ES
	7668	7894	8120	8346	8572	8798	9024	9250	9476	9702	9928	10154	10380	12217
SHIPMENT DETAILS	TECHNICAL SPECIFICATIONS				RESISTANCE TEST									
<b>Art.1719</b> 1 pz = 1  - kg 11,4/ m³ 0,297	<b>Art.1719</b> COL requirement m² 1.86 H 140 cm. COM Meterage m 1.21													
FIRE RETARDANT TEST														



# Norma Bar Stool

Design by Lievore Altherr Molina, 2005

Bar stool with steel frame and upholstered legs. Polyurethane shell upholstered in hard leather without padding. Seat height 76 cm.

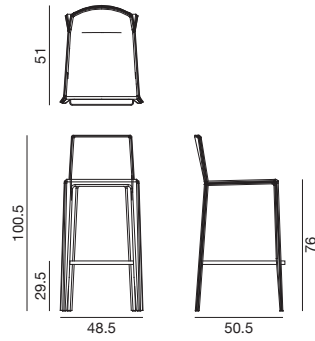

<b>SEK ART. 1713</b>	CT	
	8466	
<b>SHIPMENT DETAILS</b>	<b>TECHNICAL SPECIFICATIONS</b>	<b>RESISTANCE TEST</b>
<b>Art.1713</b> 1 pz = 1  - kg 11,4/ m³ 0,297		
<b>FIRE RETARDANT TEST</b>		



# Norma Bar Stool

Design by Lievore Altherr Molina, 2005

Bar stool with steel frame and upholstered legs. Polyurethane shell upholstered in fabric, leather, coated fabric or customer's material. Seat height 76 cm.

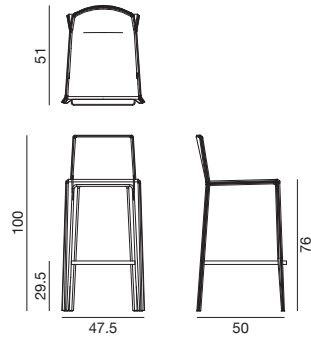

SEK ART. 1712	A	B COM	C COL	D	E	F	G	H	I	J	K	L	M	ES
	7668	7894	8120	8346	8572	8798	9024	9250	9476	9702	9928	10154	10380	12217
<b>SHIPMENT DETAILS</b>	<b>TECHNICAL SPECIFICATIONS</b>				<b>RESISTANCE TEST</b>									
<b>Art.1712</b> 1 pz = 1  - kg 9,5/ m³ 0,297	<b>Art.1712</b> COL requirement m² 1.86 H 140 cm. COM Meterage m 1.21				• EN 1728:2012 - EN 16139:2013 6.15					• EN 1728:2012 - EN 16139:2013 6.16				
<b>FIRE RETARDANT TEST</b>														







# PLY STOOL

Design by  
Lievore Altherr Molina  
2013



# Ply Stool

## Collection overview

Available in the Chairs and Stools section

---

### Type



Stool h 44 cm



Stool



Stool bar

---

# Ply Table

Collection overview  
Available in the Tables section

---

## Type



h 44 cm



h 36 cm



---

## Shape



37 x 39 cm



93 x 99 cm



93 x 53 cm



93 x 53 cm



55 x 54 cm

---

## Finishes

— Wood

# Ply

Design by Lievore Altherr Molina, 2013

Low table with oak veneer three-leg base, available in natural oak and black finishes. It is provided with glides with felt insert for wood floors. Height 44 cm.

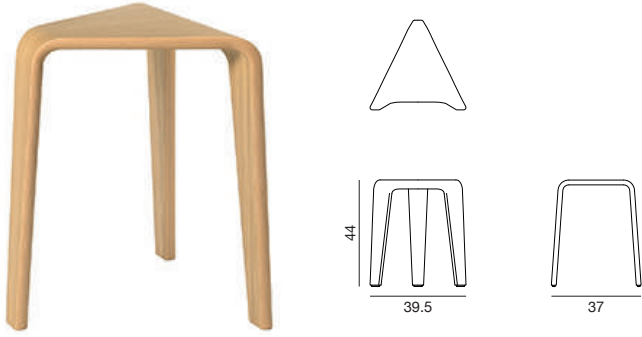

<b>SEK ART. 3800</b>	WOOD	
	4727	
<b>SHIPMENT DETAILS</b>	<b>TECHNICAL SPECIFICATIONS</b>	<b>RESISTANCE TEST</b>
Art.3800 1 pz = 1  - kg 3/ m³ 0,072		
<b>FIRE RETARDANT TEST</b>		

Frame Base



L0006 L0022



# Ply Counter Stool

Design by Lievore Altherr Molina, 2013

Stool with oak veneer three-leg base and chromed steel footrest. It is available in natural oak and black finishes and provided with glides with felt insert for wood floors. Seat height 64 cm.

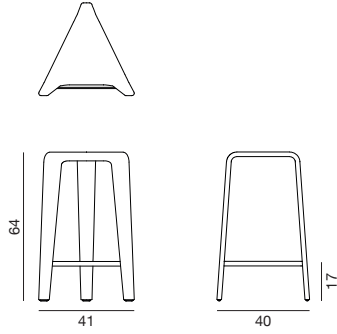

<b>SEK ART. 3801</b>	WOOD	
	7490	
<b>SHIPMENT DETAILS</b>	<b>TECHNICAL SPECIFICATIONS</b>	<b>RESISTANCE TEST</b>
Art.3801 1 pz = 1  - kg 5,2/ m² 0,172		
<b>FIRE RETARDANT TEST</b>		

Frame Base

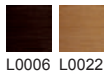

L0006 L0022



# Ply Bar Stool

Design by Lievore Altherr Molina, 2013

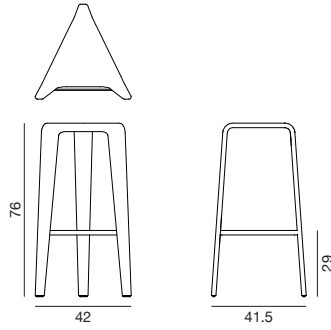

Bar stool with oak veneer three-leg base and chromed steel footrest. It is available in natural oak and black finishes and provided with glides with felt insert for wood floors. Seat height 76 cm.

<b>SEK ART. 3802</b>	<b>WOOD</b>	
	8395	
<b>SHIPMENT DETAILS</b>	<b>TECHNICAL SPECIFICATIONS</b>	<b>RESISTANCE TEST</b>
<b>Art.3802</b> 1 pz = 1  - kg 5,44/ m³ 0,172		<ul style="list-style-type: none"> <li>• EN 1728:2012 - EN 16139:2013 6.15</li> <li>• EN 1728:2012 - EN 16139:2013 6.17</li> <li>• EN 1728:2012 - EN 16139:2013 6.21</li> <li>• EN 1728:2012 - EN 16139:2013 6.25</li> <li>• EN 1728:2012 - EN 16139:2013 6.5</li> <li>• EN 1728:2012 - EN 16139:2013 6.9</li> </ul> <ul style="list-style-type: none"> <li>• EN 1728:2012 - EN 16139:2013 6.16</li> <li>• EN 1728:2012 - EN 16139:2013 6.18</li> <li>• EN 1728:2012 - EN 16139:2013 6.24</li> <li>• EN 1728:2012 - EN 16139:2013 6.4</li> <li>• EN 1728:2012 - EN 16139:2013 6.8</li> </ul>
<b>FIRE RETARDANT TEST</b>		

Frame Base

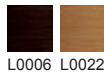

L0006 L0022



# SAARI CHAIR

---

Design by  
Lievore Altherr Molina  
2009





# Saari Chair

## Collection overview Available in the Chairs and Stools section

### Type



4 legs armchair  
Options:  
Castors

4 legs armchair  
Options:  
Castors



Armchair with aluminium  
swivel trestle base

Armchair with aluminium  
swivel trestle base

Armchair with aluminium  
fixed trestle base mounted  
on self-braking castors

Armchair with aluminium  
fixed trestle base mounted  
on self-braking castors

### Options



— Castors

# Saari Sofa

## Collection overview

Available in the Sofas and Benches section

---

### Type



Armchair — 71 cm



Armchair — 82,5 cm



Armchair XL — 90 cm



Sofa — 2 seats



Sofa — 3 seats



Bench — 2 seats

---

### Legs finishes



Veneered steel



Chromed / Powdercoated

---

### Options



USB

# Saari

Design by Lievore Altherr Molina, 2009

Armchair with four-leg steel base available polished or powder-coated, or with oak-effect reconstituted veneer base. Frame in metal and plywood is upholstered in leather, coated fabric, fabric or customer's material. Also available with castors.

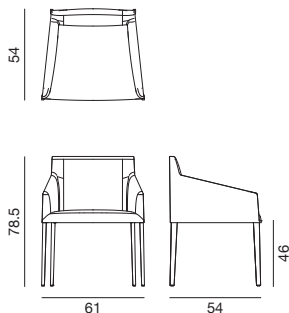

<b>SEK ART. 2702</b>	<b>A</b>	<b>B COM</b>	<b>C COL</b>	<b>D</b>	<b>E</b>	<b>F</b>	<b>G</b>	<b>H</b>	<b>I</b>	<b>J</b>	<b>K</b>	<b>L</b>	<b>M</b>	<b>ES</b>
veneered legs	11205	11574	11943	12312	12681	13050	13419	13788	14157	14526	14895	15264	15633	19158
polished	9692	10061	10430	10799	11168	11537	11906	12275	12644	13013	13382	13751	14120	17658
powdercoated	9407	9776	10145	10514	10883	11252	11621	11990	12359	12728	13097	13466	13835	17385
Castors	+ 988													

<b>SHIPMENT DETAILS</b>	<b>TECHNICAL SPECIFICATIONS</b>	<b>RESISTANCE TEST</b>
<b>Art. 2702</b> 1 pz = 1  - kg 13/ m² 0,306	<b>Art.2702</b> COL requirement m² 3.25 H 140 cm. COM Meterage m 1.82	
<b>FIRE RETARDANT TEST</b> Classe 1IM Omologazione Italia Field Kvadrat. Coated fabric Valencia Spradling.		

Frame Base

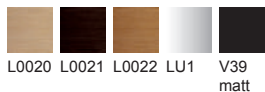

# Saari

Design by Lievore Altherr Molina, 2009

Armchair with four-leg steel base available polished or powder-coated, or with oak-effect reconstituted veneer base. Frame in metal and plywood is upholstered in leather, coated fabric, fabric or customer's material. Also available with castors.

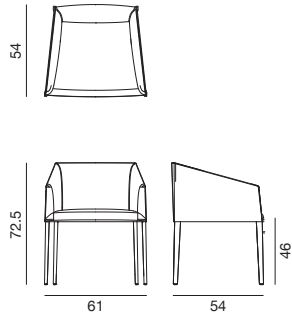

<b>SEK ART. 2703</b>	<b>A</b>	<b>B COM</b>	<b>C COL</b>	<b>D</b>	<b>E</b>	<b>F</b>	<b>G</b>	<b>H</b>	<b>I</b>	<b>J</b>	<b>K</b>	<b>L</b>	<b>M</b>	<b>ES</b>
VENEERED LEGS	11205	11574	11943	12312	12681	13050	13419	13788	14157	14526	14895	15264	15633	19158
POLISHED	9692	10061	10430	10799	11168	11537	11906	12275	12644	13013	13382	13751	14120	17658
POWDERCOATED	9407	9776	10145	10514	10883	11252	11621	11990	12359	12728	13097	13466	13835	17385
Castors	+ 988													

SHIPMENT DETAILS	TECHNICAL SPECIFICATIONS	RESISTANCE TEST
<b>Art. 2703</b> 1 pz = 1  - kg 13,5/ m³ 0,363	<b>Art.2703</b> COL requirement m² 3.25 H 140 cm. COM Meterage m 1.79	
<b>FIRE RETARDANT TEST</b> Classe 1IM Omologazione Italia Field Kvadrat. Coated fabric Valencia Spradling.		

Frame Base

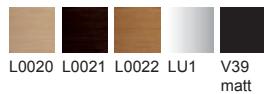

# Saari

Design by Lievore Altherr Molina, 2009

Armchair with polished or powder-coated aluminium swivel trestle base. Plywood shell is upholstered in leather, coated fabric, fabric or customer's own fabric.

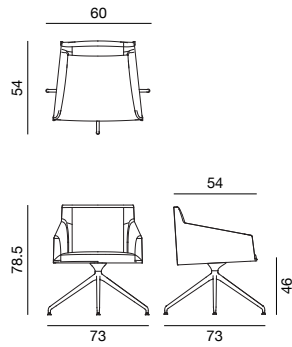

Accessories:  
Set of glides Art. 2015

SEK ART. 2705	A	B COM	C COL	D	E	F	G	H	I	J	K	L	M	ES
POLISHED	10729	11098	11467	11836	12205	12574	12943	13312	13681	14050	14419	14788	15157	19480
POWDERCOATED	10443	10812	11181	11550	11919	12288	12657	13026	13395	13764	14133	14502	14871	19194

SHIPMENT DETAILS	TECHNICAL SPECIFICATIONS	RESISTANCE TEST
<b>Art. 2705</b> 1 pz = 1  - kg 17,5/ m³ 0,352	<b>Art.2705</b> COL requirement m² 3.25 H 140 cm. COM Meterage m 1.82	
<b>FIRE RETARDANT TEST</b> Classe 1IM Omologazione Italia Field Kvadrat. Coated fabric Valencia Spradling.		

Frame Base

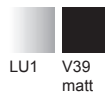

# Saari

Design by Lievore Altherr Molina, 2009

Tub armchair with polished or powder-coated aluminium swivel trestle base. Plywood shell upholstered in leather, coated fabric, fabric or customer's own fabric.

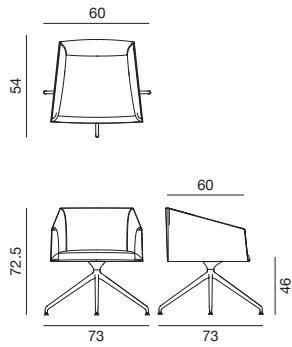

Accessories:  
Set of glides Art. 2015

<b>SEK ART. 2706</b>	<b>A</b>	<b>B COM</b>	<b>C COL</b>	<b>D</b>	<b>E</b>	<b>F</b>	<b>G</b>	<b>H</b>	<b>I</b>	<b>J</b>	<b>K</b>	<b>L</b>	<b>M</b>	<b>ES</b>
POLISHED	10729	11098	11467	11836	12205	12574	12943	13312	13681	14050	14419	14788	15157	19480
POWDERCOATED	10443	10812	11181	11550	11919	12288	12657	13026	13395	13764	14133	14502	14871	19194

<b>SHIPMENT DETAILS</b>	<b>TECHNICAL SPECIFICATIONS</b>	<b>RESISTANCE TEST</b>
<b>Art. 2706</b> 1 pz = 1  - kg 18/ m² 0,365	<b>Art.2706</b> COL requirement m² 3.25 H 140 cm. COM Meterage m 1.82	
<b>FIRE RETARDANT TEST</b> Classe 1IM Omologazione Italia Field Kvadrat. Coated fabric Valencia Spradling.		

Frame Base

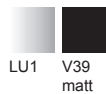

# Saari

Design by Lievore Altherr Molina, 2009

Armchair with polished or powder-coated aluminium fixed trestle base mounted on self-braking castors. Plywood shell upholstered in leather, coated fabric, fabric or customer's own fabric.

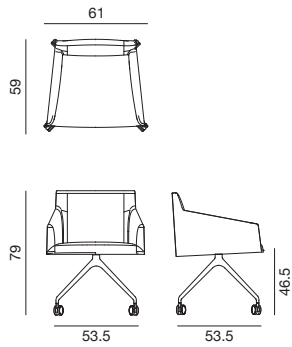

SEK ART. 2708	A	B COM	C COL	D	E	F	G	H	I	J	K	L	M	ES
POLISHED	11205	11574	11943	12312	12681	13050	13419	13788	14157	14526	14895	15264	15633	19921
POWDERCOATED	10907	11276	11645	12014	12383	12752	13121	13490	13859	14228	14597	14966	15335	19634

SHIPMENT DETAILS	TECHNICAL SPECIFICATIONS	RESISTANCE TEST
<b>Art. 2708</b> 1 pz = 1  - kg 17,5/ m³ 0,393	<b>Art.2708</b> COL requirement m² 3.25 H 140 cm. COM Meterage m 1.82	
<b>FIRE RETARDANT TEST</b> Classe 1IM Omologazione Italia Field Kvadrat. Coated fabric Valencia Spradling.		

Frame Base

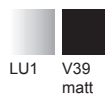

# Saari

Design by Lievore Altherr Molina, 2009

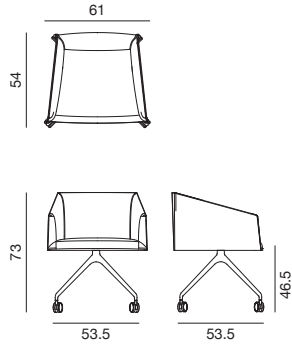

Tub armchair with polished or powder-coated aluminium fixed trestle base mounted on self-braking castors. Plywood shell upholstered in leather, coated fabric, fabric or customer's own fabric.

SEK ART. 2709	A	B COM	C COL	D	E	F	G	H	I	J	K	L	M	ES
POLISHED	11205	11574	11943	12312	12681	13050	13419	13788	14157	14526	14895	15264	15633	19921
POWDERCOATED	10907	11276	11645	12014	12383	12752	13121	13490	13859	14228	14597	14966	15335	19634

SHIPMENT DETAILS	TECHNICAL SPECIFICATIONS	RESISTANCE TEST
<b>Art.2709</b> 1 pz = 1  - kg 18/ m² 0,379	<b>Art.2709</b> COL requirement m² 3.25 H 140 cm. COM Meterage m 1.82	

FIRE RETARDANT TEST
Classe 1IM Omologazione Italia Field Kvadrat. Coated fabric Valencia Spradling.

Frame Base

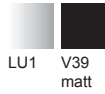





# SAYA

---

Design by  
Lievore Altherr Molina  
2013

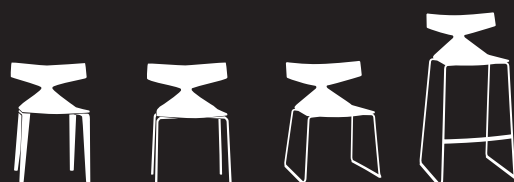

# Saya

## Collection overview

---

### Bases



4 wooden legs



4 legs in chromed steel



Sled



Counter stool sled



Bar stool sled

---

### Shells

#### Wood



Upholstered cushion

---

# Saya

Design by Lievore Altherr Molina, 2012

Chair with oak veneer four-leg base, available in 4 finishes. Optional glides with felt for wooden floors are included.

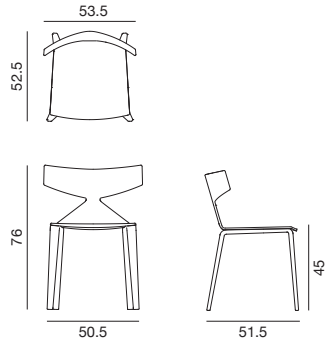

<b>SEK ART. 3700</b>	WOOD	
WOOD LEGS	7275	
<b>SHIPMENT DETAILS</b>	<b>TECHNICAL SPECIFICATIONS</b>	<b>RESISTANCE TEST</b>
Art.3700 1 pz = 1  - kg 6,72/ m³ 0,365		
<b>FIRE RETARDANT TEST</b>		

Frame Base



# Saya

Design by Lievore Altherr Molina, 2012

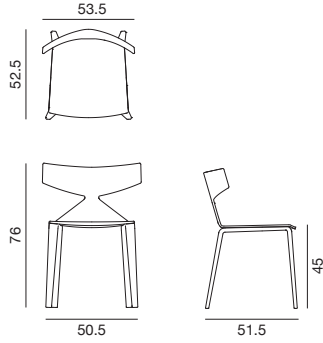

Chair with oak veneer four-leg base available in 4 finishes and with fabric, leather, coated fabric or customer's material upholstered cushion applied on the seat. Optional glides with felt for wooden floors are available upon request.

SEK ART. 3714	A	B COM	C COL	D	E	F	G	H	I	J	K	L	M	ES
WOOD LEGS	9061	9180	9299	9418	9537	9656	9775	9894	10013	10132	10251	10370	10489	11002
<b>SHIPMENT DETAILS</b>	<b>TECHNICAL SPECIFICATIONS</b>				<b>RESISTANCE TEST</b>									
Art.3714 1 pz = 1  - kg 6,72/ m³ 0,365	Art.3714 COL requirement m² 0.672 H 140 cm. COM Meterage m 0.59													
<b>FIRE RETARDANT TEST</b>														

Frame Base



# Saya

Design by Lievore Altherr Molina, 2012

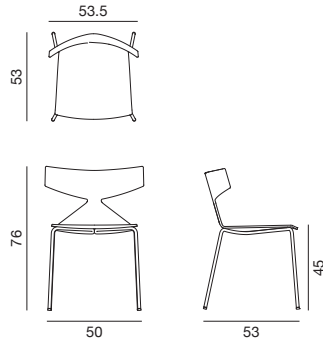

Chair with chromed or powdercoated steel four-leg base and oak veneer shell, available in 4 finishes. Optional glides with felt for wooden floors are available upon request.

– without tools up to 10 units

<b>SEK ART. 3701</b>	WOOD	
CHROMED / POWDERCOATED	4155	
<b>SHIPMENT DETAILS</b>	<b>TECHNICAL SPECIFICATIONS</b>	<b>RESISTANCE TEST</b>
<b>Art.3701</b> 1 pz = 2  - kg 9,25/ m³ 0,291 4 pz = 2  - kg 26,54/ m³ 0,401 		
<b>FIRE RETARDANT TEST</b>		

Frame Base

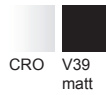

Shell

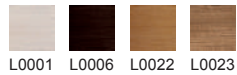

# Saya

Design by Lievore Altherr Molina, 2012

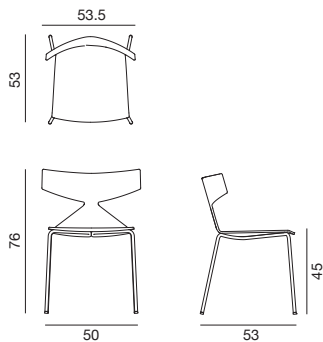

Chair with chromed or powdercoated steel four-leg base and oak veneer shell, available in 4 finishes. Fabric, leather, coated fabric or customer's fabric upholstered cushion applied on the seat. Optional glides with felt for wooden floors are available upon request.

SEK ART. 3710	A	B COM	C COL	D	E	F	G	H	I	J	K	L	M	ES
CHROMED / POWDERCOATED	5953	6072	6191	6310	6429	6548	6667	6786	6905	7024	7143	7262	7381	7906
<b>SHIPMENT DETAILS</b>		<b>TECHNICAL SPECIFICATIONS</b>				<b>RESISTANCE TEST</b>								
<b>Art.3710</b> 1 pz = 2  - kg 9,25/ m³ 0,291 4 pz = 2  - kg 26,54/ m³ 0,401 		<b>Art.3710</b> COL requirement m² 0.672 H 140 cm. COM Meterage m 0.59												
<b>FIRE RETARDANT TEST</b>														
Classe 1IM Omologazione Italia Coated fabric Valencia Spradling.														

**Frame Base**

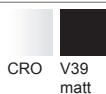

CRO V39  
matt

**Shell**



L0001 L0006 L0022 L0023



# Saya

Design by Lievore Altherr Molina, 2012

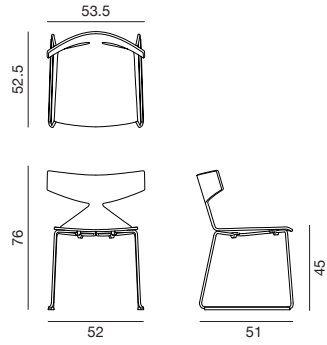

Chair with chromed or powdercoated steel sled base and oak veneer shell, available in 4 finishes. Optional glides with felt for wooden floors are available upon request.

– without tools up to 10 units

<b>SEK ART. 3702</b>	WOOD	
CHROMED / POWDERCOATED	4882	
<b>SHIPMENT DETAILS</b>	<b>TECHNICAL SPECIFICATIONS</b>	<b>RESISTANCE TEST</b>
<b>Art.3702</b> 1 pz = 2  - kg 11,66/ m³ 0,3 4 pz = 2  - kg 32,22/ m³ 0,41 		<ul style="list-style-type: none"> <li>• EN 1728:2012 - EN 16139:2013 6.15</li> <li>• EN 1728:2012 - EN 16139:2013 6.17</li> <li>• EN 1728:2012 - EN 16139:2013 6.24</li> <li>• EN 1728:2012 - EN 16139:2013 6.4</li> <li>• EN 1728:2012 - EN 16139:2013 6.16</li> <li>• EN 1728:2012 - EN 16139:2013 6.18</li> <li>• EN 1728:2012 - EN 16139:2013 6.25</li> <li>• EN 1728:2012 - EN 16139:2013 6.5</li> </ul>
<b>FIRE RETARDANT TEST</b>		

Frame Base



Shell

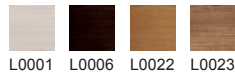

Stackable



Standard: polycarbonate glide with polyurethane insert.



Upon request: polycarbonate glide with felt insert.





# Saya

Design by Lievore Altherr Molina, 2012

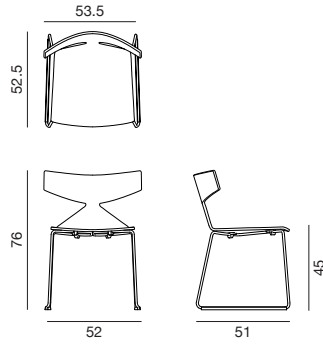

Chair with chromed or powdercoated steel sled base and oak veneer shell. It is available in 4 finishes and with fabric, leather, coated fabric or customer's material upholstered cushion applied on the seat. Optional glides with felt for wooden floors are available upon request.

SEK ART. 3711	A	B COM	C COL	D	E	F	G	H	I	J	K	L	M	ES
CHROMED / POWDERCOATED	6680	6799	6918	7037	7156	7275	7394	7513	7632	7751	7870	7989	8108	8633
<b>SHIPMENT DETAILS</b>		<b>TECHNICAL SPECIFICATIONS</b>				<b>RESISTANCE TEST</b>								
<b>Art.3711</b> 1 pz = 2  - kg 11,66/ m³ 0,3 4 pz = 2  - kg 32,22/ m³ 0,41 		<b>Art.3711</b> COL requirement m² 0.672 H 140 cm. COM Meterage m 0.59												
<b>FIRE RETARDANT TEST</b>														
Classe 1IM Omologazione Italia Coated fabric Valencia Spradling.														

## Frame Base



CRO V39  
matt

## Shell



L0001 L0006 L0022 L0023



Standard: polycarbonate glide with polyurethane insert.



Upon request: polycarbonate glide with felt insert.



# Saya Bar Stool

Design by Lievore Altherr Molina, 2012

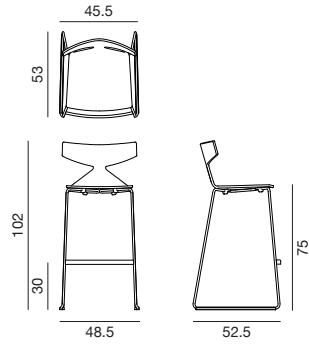

Bar stool with chromed or powdercoated steel sled base and oak veneer shell, available in 4 finishes. Optional glides with felt for wooden floors are available upon request. Height 75 cm.

– without tools up to 10 units

<b>SEK ART. 3704</b>	WOOD	
CHROMED / POWDERCOATED	5489	
<b>SHIPMENT DETAILS</b>	<b>TECHNICAL SPECIFICATIONS</b>	<b>RESISTANCE TEST</b>
<b>Art.3704</b> 1 pz = 2  - kg 11,22/ m³ 0,42 4 pz = 2  - kg 33,34/ m³ 0,47 		<ul style="list-style-type: none"> <li>• EN 1728:2012 - EN 16139:2013 6.15</li> <li>• EN 1728:2012 - EN 16139:2013 6.17</li> <li>• EN 1728:2012 - EN 16139:2013 6.21</li> <li>• EN 1728:2012 - EN 16139:2013 6.25</li> <li>• EN 1728:2012 - EN 16139:2013 6.5</li> <li>• EN 1728:2012 - EN 16139:2013 6.9</li> </ul> <ul style="list-style-type: none"> <li>• EN 1728:2012 - EN 16139:2013 6.16</li> <li>• EN 1728:2012 - EN 16139:2013 6.18</li> <li>• EN 1728:2012 - EN 16139:2013 6.24</li> <li>• EN 1728:2012 - EN 16139:2013 6.4</li> <li>• EN 1728:2012 - EN 16139:2013 6.8</li> </ul>
<b>FIRE RETARDANT TEST</b>		

Frame Base



Shell

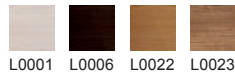

Stackable



Standard: polycarbonate glide with polyurethane insert.



Upon request: polycarbonate glide with felt insert.



# Saya Bar Stool

Design by Lievore Altherr Molina, 2012

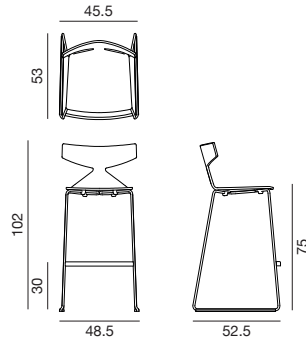

Bar stool with chromed or powdercoated steel sled base and oak veneer shell. It is available in 4 finishes and with fabric, leather, coated fabric or customer's material upholstered cushion applied on the seat. Optional glides with felt for wooden floors are available upon request. Seat height 75 cm.

SEK ART. 3713	A	B COM	C COL	D	E	F	G	H	I	J	K	L	M	ES
CHROMED / POWDERCOATED	6894	7013	7132	7251	7370	7489	7608	7727	7846	7965	8084	8203	8322	8847
<b>SHIPMENT DETAILS</b>		<b>TECHNICAL SPECIFICATIONS</b>				<b>RESISTANCE TEST</b>								
<b>Art.3713</b> 1 pz = 2  - kg 11,22/ m³ 0,42 4 pz = 2  - kg 33,34/ m³ 0,47 		<b>Art.3713</b> COL requirement m² 0.564 H 140 cm. COM Meterage m 0.48				<ul style="list-style-type: none"> <li>• EN 1728:2012 - EN 16139:2013 6.15</li> <li>• EN 1728:2012 - EN 16139:2013 6.17</li> <li>• EN 1728:2012 - EN 16139:2013 6.21</li> <li>• EN 1728:2012 - EN 16139:2013 6.25</li> <li>• EN 1728:2012 - EN 16139:2013 6.5</li> <li>• EN 1728:2012 - EN 16139:2013 6.9</li> </ul>				<ul style="list-style-type: none"> <li>• EN 1728:2012 - EN 16139:2013 6.16</li> <li>• EN 1728:2012 - EN 16139:2013 6.18</li> <li>• EN 1728:2012 - EN 16139:2013 6.24</li> <li>• EN 1728:2012 - EN 16139:2013 6.4</li> <li>• EN 1728:2012 - EN 16139:2013 6.8</li> </ul>				
<b>FIRE RETARDANT TEST</b>														
Classe 1IM Omologazione Italia Coated fabric Valencia Spradling.														

## Frame Base



CRO V39  
matt



## Shell



L0001 L0006 L0022 L0023



Standard: polycarbonate glide with polyurethane insert.



Upon request: polycarbonate glide with felt insert.



# Saya Counter Stool

Design by Lievore Altherr Molina, 2012

Stool with chromed or powdercoated steel sled base and oak veneer shell, available in 4 finishes. Optional glides with felt for wooden floors are available upon request. Height 65 cm.

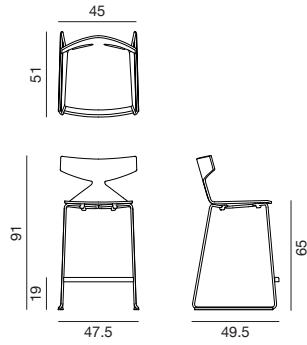

– without tools up to 10 units

<b>SEK ART. 3703</b>	WOOD	
CHROMED / POWDERCOATED	5489	
<b>SHIPMENT DETAILS</b>	<b>TECHNICAL SPECIFICATIONS</b>	<b>RESISTANCE TEST</b>
<b>Art.3703</b> 1 pz = 2  - kg 10,74/ m³ 0,36 4 pz = 2  - kg 31,42/ m³ 0,41 		
<b>FIRE RETARDANT TEST</b>		

Frame Base



Shell

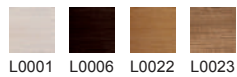

Stackable



Standard: polycarbonate glide with polyurethane insert.



Upon request: polycarbonate glide with felt insert.



# Saya Counter Stool

Design by Lievore Altherr Molina, 2012

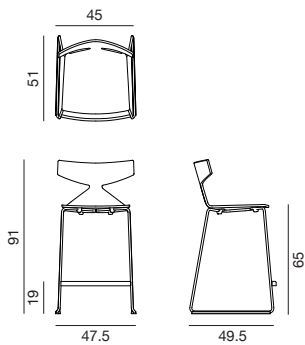

Stool with chromed or powdercoated steel sled base and oak veneer shell. It is available in 4 finishes and with fabric, leather, coated fabric or customer's material upholstered cushion applied on the seat. Optional glides with felt for wooden floors are available upon request. Seat height 65 cm.

SEK ART. 3712	A	B COM	C COL	D	E	F	G	H	I	J	K	L	M	ES
CHROMED / POWDERCOATED	6894	7013	7132	7251	7370	7489	7608	7727	7846	7965	8084	8203	8322	8847
<b>SHIPMENT DETAILS</b>		<b>TECHNICAL SPECIFICATIONS</b>				<b>RESISTANCE TEST</b>								
<b>Art.3712</b> 1 pz = 2  - kg 10,74/ m³ 0,36 4 pz = 2  - kg 31,42/ m³ 0,41 		<b>Art.3712</b> COL requirement m² 0.564 H 140 cm. COM Meterage m 0.48												
<b>FIRE RETARDANT TEST</b>														
Classe 1IM Omologazione Italia Coated fabric Valencia Spradling.														

## Frame Base



CRO V39  
matt



## Shell



L0001 L0006 L0022 L0023



Standard: polycarbonate glide with polyurethane insert.



Upon request: polycarbonate glide with felt insert.



# STACY

---

Design by  
Lievore Altherr  
2018

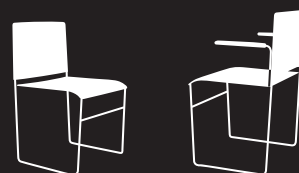

# Stacy

## Collection overview

### Bases



Sled



Sled with armrests

### Seat and backrest



Polypropylene seat and backrest



Upholstered seat and polypropylene backrest



Seat and backrest upholstered in one-colour

### Options



Anti-panic writing tablet — only available for chromed or powdercoated V25 sled



Row spacer

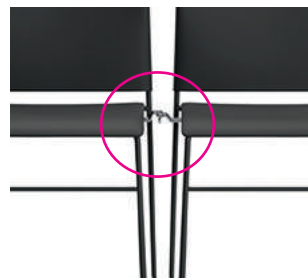

Chair linking system



Trolley

# Stacy

## Instructions for modular arrangements

### Two-colour polypropylene versions



Polypropylene seat and backrest are available in a two colour version, with black seat and backrest in one of the other four colours available

### Armrest layout



Polypropylene seat and backrest: polypropylene armrests come in the same colour as the seat



Upholstered seat and polypropylene backrest: the polypropylene armrest pad comes in the same colour as the backrest



Upholstered seat and backrest: the polypropylene armrest pad is available in 5 colours

## Stackability

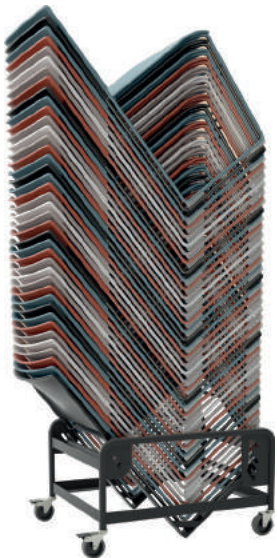

**Max 40 pcs**  
For the polypropylene version with no armrests

**Max 25 pcs**  
For all other versions

## Glides color

Chromed bases: black glides.  
Powdercoated bases: glides in the same color of the base

Upholstered versions: transparent stacking glides.

## Quick linking

Quick linking system to be selected when placing an order.  
Only versions with armrests.

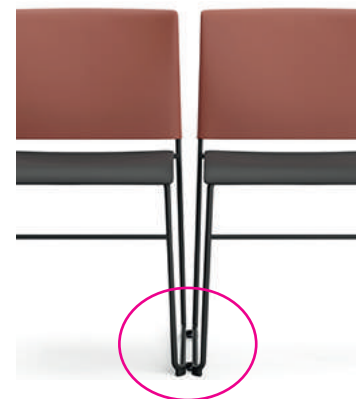



# Stacy

Design by Lievore Altherr, 2018

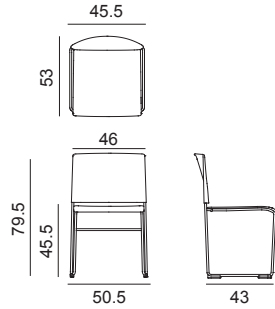

Chair on sled base in chromed or powder-coated steel.

Polypropylene seat and backrest available in one matching colour, in 5 finishes, or in a two colour version, with black seat and backrest in one of the other four colours available. Stackability: up to 40 items by using the dedicated trolley. Quick linking system to be selected when placing an order.

Accessories:

- Anti-panic writing tablet Art. 6606
- Chair linking system Art. 6607
- Row spacer Art. 6609
- Numbers for chairs and lines Art. 6610
- Trolley for stacking chairs Art. 6611

Stackability:

(should the weight exceed 25 kilos a handling tool must be used).

- without tools up to 10 units
- with trolley up to 40 units
- with link: without tools up to 6 units
- with link: with trolley up to 25 units

<b>SEK ART. 6600</b>	PS	
CHROMED / POWDERCOATED	2251	
Polypropylene fire retardant	+ 251	(For all finishes qty min. 300 pcs)
<b>SHIPMENT DETAILS</b>	<b>TECHNICAL SPECIFICATIONS</b>	<b>RESISTANCE TEST</b>
<b>Art.6600</b> 1 pz = 1  - kg 5,3/ m³ 0,319 4 pz = 1  - kg 21,2/ m³ 0,369	<b>Art.6600</b> *Classe 1, 2, 11M: fire retardant version available with surcharge and eventual minimum batch	<ul style="list-style-type: none"> <li>• EN 14703:2007 7.3</li> <li>• ANSI/BIFMA X5.1-2017/10</li> <li>• ANSI/BIFMA X5.1-2017/17</li> <li>• ANSI/BIFMA X5.1-2017/7</li> <li>• ANSI/BIFMA X5.1-2017/11</li> <li>• ANSI/BIFMA X5.1-2017/24</li> </ul>
<b>FIRE RETARDANT TEST</b>		
* FIRE RETARDANT VERSION WITH SURCHARGE * Classe 2 Omologazione Italia Polipropilene.		

## Frame Base



## Backrest

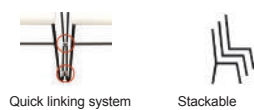

# Stacy

Design by Lievore Altherr, 2018

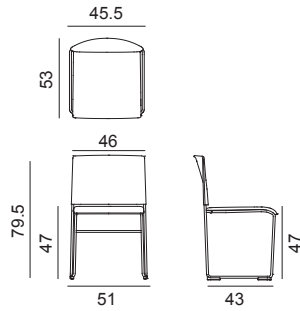

Chair on sled base in chromed or powder-coated steel. Seat upholstery available in fabric, leather, coated fabric, or customer's material and polypropylene backrest available in 5 colours. Stackability: up to 25 items by using the dedicated trolley. Quick linking system to be selected when placing an order.

#### Accessories:

- Anti-panic writing tablet Art. 6606
- Chair linking system Art. 6607
- Row spacer Art. 6609
- Numbers for chairs and lines Art. 6610
- Trolley for stacking chairs Art. 6611

#### Stackability:

(should the weight exceed 25 kilos a handling tool must be used).

- without tools up to 8 units
- with trolley up to 25 units

SEK ART. 6601	A	B COM	C COL	D	E	F	G	H	I	J	K	L	M	ES
CHROMED / POWDERCOATED	3108	3203	3298	3393	3488	3583	3678	3773	3868	3963	4058	4153	4248	4656
<b>SHIPMENT DETAILS</b>		<b>TECHNICAL SPECIFICATIONS</b>				<b>RESISTANCE TEST</b>								
<b>Art.6601</b> 1 pz = 1  - kg 6/ m³ 0,319 4 pz = 1  - kg 24/ m³ 0,369		<b>Art.6601</b> COL requirement m² 0.84 H 140 cm. COM Meterage m 0.66 *Classe 1, 2, 1IM: fire retardant version available with surcharge and eventual minimum batch												
<b>FIRE RETARDANT TEST</b>														
Classe 1IM Omologazione Italia Field Kvadrat. Remix 3 Kvadrat. Umami Kvadrat.														

#### Frame Base



#### Backrest

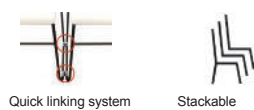

# Stacy

Design by Lievore Altherr, 2018

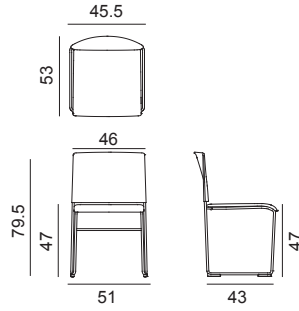

Chair on sled base in chromed or coated steel. Backrest and seat upholstery available in fabric, leather, coated fabric, or customer's material. Stackability: up to 25 items by using the dedicated trolley. Quick linking system to be selected when placing an order.

Accessories:  
 Anti-panic writing tablet Art. 6606  
 Chair linking system Art. 6607  
 Row spacer Art. 6609  
 Numbers for chairs and lines Art. 6610  
 Trolley for stacking chairs Art. 6611

Stackability:  
 (should the weight exceed 25 kilos a handling tool must be used).  
 – without tools up to 8 units  
 – with trolley up to 25 units

SEK ART. 6602	A	B COM	C COL	D	E	F	G	H	I	J	K	L	M	ES
CHROMED / POWDERCOATED	3644	3954	4264	4574	4884	5194	5504	5814	6124	6434	6744	7054	7364	8716
<b>SHIPMENT DETAILS</b>		<b>TECHNICAL SPECIFICATIONS</b>				<b>RESISTANCE TEST</b>								
<b>Art.6602</b> 1 pz = 1  - kg 6/ m³ 0,319 4 pz = 1  - kg 24/ m³ 0,369		<b>Art.6602</b> COL requirement m² 1.86 H 140 cm. COM Meterage m 0.66 *Classe 1, 2, 11M: fire retardant version available with surcharge and eventual minimum batch												
<b>FIRE RETARDANT TEST</b>														
Classe 11M Omologazione Italia Field Kvadrat. Remix 3 Kvadrat. Umami Kvadrat.														

## Frame Base



# Stacy

Design by Lievore Altherr, 2018

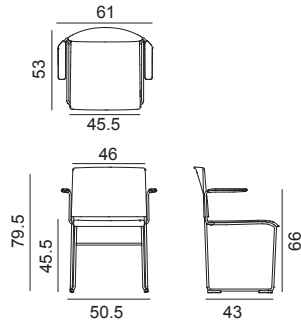

Chair on sled base with armrests in chromed or powder-coated steel. Polypropylene seat and backrest available in one matching colour, in 5 finishes, or in a two colour version, with black seat and backrest in one of the other four colours available. The polypropylene armrest pad comes in the same colour as the seat. Stackability: up to 25 items by using the dedicated trolley.

#### Accessories:

- Anti-panic writing tablet Art. 6606
- Chair linking system Art. 6607
- Row spacer Art. 6609
- Numbers for chairs and lines Art. 6610
- Trolley for stacking chairs Art. 6611

#### Stackability:

(should the weight exceed 25 kilos a handling tool must be used).

- without tools up to 6 units
- with trolley up to 25 units
- with link: without tools up to 4 units
- with link: with trolley up to 25 units

<b>SEK ART. 6603</b>	PS	
CHROMED / POWDERCOATED	3096	
Polypropylene fire retardant	+ 310	(For all finishes qty min. 300 pcs)
<b>SHIPMENT DETAILS</b>	<b>TECHNICAL SPECIFICATIONS</b>	<b>RESISTANCE TEST</b>
<b>Art.6603</b> 1 pz = 1  - kg 6,3/ m³ 0,319 4 pz = 1  - kg 25,2/ m³ 0,446	<b>Art.6603</b> *Classe 1, 2, 11M: fire retardant version available with surcharge and eventual minimum batch	<ul style="list-style-type: none"> <li>• EN 1728:2012 - EN 16139:2013 6.10</li> <li>• EN 1728:2012 - EN 16139:2013 6.15</li> <li>• EN 1728:2012 - EN 16139:2013 6.17</li> <li>• EN 1728:2012 - EN 16139:2013 6.20</li> <li>• EN 1728:2012 - EN 16139:2013 6.25</li> <li>• EN 1728:2012 - EN 16139:2013 6.4</li> <li>• EN 1728:2012 - EN 12520:2015 5.4.2</li> <li>• EN 1022:2018 7.3</li> </ul> <ul style="list-style-type: none"> <li>• EN 1728:2012 - EN 16139:2013 6.11</li> <li>• EN 1728:2012 - EN 16139:2013 6.16</li> <li>• EN 1728:2012 - EN 16139:2013 6.18</li> <li>• EN 1728:2012 - EN 16139:2013 6.24</li> <li>• EN 1728:2012 - EN 16139:2013 4.1-4.2</li> <li>• EN 1728:2012 - EN 16139:2013 6.5</li> <li>• EN 16139:2013 Annex C</li> </ul>
<b>FIRE RETARDANT TEST</b>		
* FIRE RETARDANT VERSION WITH SURCHARGE * Classe 2 Omologazione Italia Polipropilene.		

#### Frame Base

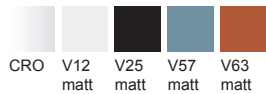

CRO V12 V25 V57 V63  
matt matt matt matt



PS00001 PS00002 PS00003 PS00004 PS00005

#### Backrest



PS00001 PS00002 PS00003 PS00004 PS00005



# Stacy

Design by Lievore Altherr, 2018

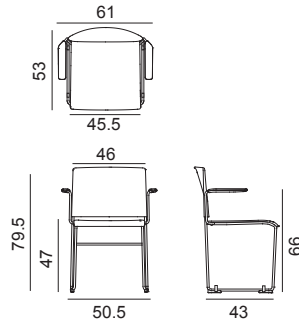

Chair on sled base with armrests in chromed or powder-coated steel. Seat upholstery available in fabric, leather, coated fabric, or customer's material and polypropylene backrest available in 5 colours. The polypropylene armrest pad comes in the same colour as the seat. Stackability: up to 25 items by using the dedicated trolley.

Accessories:  
 Anti-panic writing tablet Art. 6606  
 Chair linking system Art. 6607  
 Row spacer Art. 6609  
 Numbers for chairs and lines Art. 6610  
 Trolley for stacking chairs Art. 6611

Stackability:  
 (should the weight exceed 25 kilos a handling tool must be used).  
 – without tools up to 5 units  
 – with trolley up to 25 units

SEK ART. 6604	A	B COM	C COL	D	E	F	G	H	I	J	K	L	M	ES
CHROMED / POWDERCOATED	3929	4024	4119	4214	4309	4404	4499	4594	4689	4784	4879	4974	5069	5478
<b>SHIPMENT DETAILS</b>		<b>TECHNICAL SPECIFICATIONS</b>				<b>RESISTANCE TEST</b>								
<b>Art.6604</b> 1 pz = 1  - kg 7/ m³ 0,319 4 pz = 1  - kg 28/ m³ 0,446		<b>Art.6604</b> COL requirement m² 0.84 H 140 cm. COM Meterage m 0.66 *Classe 1, 2, 11M: fire retardant version available with surcharge and eventual minimum batch												
<b>FIRE RETARDANT TEST</b>														
Classe 11M Omologazione Italia Field Kvadrat. Remix 3 Kvadrat. Umami Kvadrat.														

## Frame Base



## Backrest



# Stacy

Design by Lievore Altherr, 2018

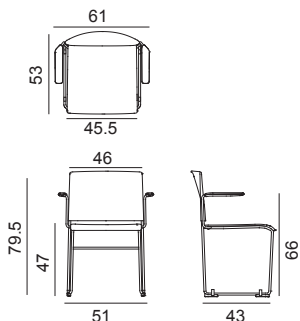

Chair on sled base with armrests in chromed or powder-coated steel. Backrest and seat upholstery available in fabric, leather, coated fabric, or customer's fabric. The polypropylene armrest pad is available in 5 colours. Stackability: up to 25 items by using the dedicated trolley.

#### Accessories:

- Anti-panic writing tablet Art. 6606
- Chair linking system Art. 6607
- Row spacer Art. 6609
- Numbers for chairs and lines Art. 6610
- Trolley for stacking chairs Art. 6611

#### Stackability:

(should the weight exceed 25 kilos a handling tool must be used).

- without tools up to 5 units
- with trolley up to 25 units

SEK ART. 6605	A	B COM	C COL	D	E	F	G	H	I	J	K	L	M	ES
CHROMED / POWDERCOATED	4465	4775	5085	5395	5705	6015	6325	6635	6945	7255	7565	7875	8185	9537







SHIPMENT DETAILS	TECHNICAL SPECIFICATIONS	RESISTANCE TEST
<b>Art.6605</b> 1 pz = 1  - kg 7/ m³ 0,319 4 pz = 1  - kg 28/ m³ 0,446	<b>Art.6605</b> COL requirement m² 1.86 H 140 cm. COM Meterage m 0.66 *Classe 1, 2, 1IM: fire retardant version available with surcharge and eventual minimum batch	
<b>FIRE RETARDANT TEST</b> Classe 1IM Omologazione Italia Field Kvadrat. Remix 3 Kvadrat. Umami Kvadrat.		









#### Frame Base



# Accessories

Design by Lievore Altherr

<p><b>SEK ART. 6606</b></p>  <p>Anti-panic writing tablet with quick linking system in anthracite HPL, 25.5 x 26.6 cm</p>	<p><b>SEK ART. 6607</b></p>  <p>Linking system (suitable both for chairs with and without armrests)</p>	<p><b>SEK ART. 6609</b></p>  <p>Row spacer</p>	<p><b>SEK ART. 6610</b></p>  <p>Numbers for chairs and lines</p>	<p><b>SEK ART. 6611</b></p>  <p>Trolley for stacking chairs (up to 40 chairs)</p>
<p>1715</p>	<p>488</p>	<p>369</p>	<p>35</p>	<p>5846</p>
<p><b>SEK ART. 6612</b></p>  <p>Trolley for writing tablet (up to 40)</p>				
<p>7156</p>				

SHIPMENT DETAILS	TECHNICAL SPECIFICATIONS	RESISTANCE TEST
<p><b>Art. 6606</b>            1 pz = 1  - kg 8,5/ m³ 0,005            4 pz = 1  - kg 32,5/ m³ 0,015</p> <p><b>Art. 6607</b>            1 pz = 1  - kg 0,73/ m³ 0,006</p> <p><b>Art. 6609</b>            2 pz = 1  - kg 3/ m³ 0,002            4 pz = 1  - kg 5,8/ m³ 0,003</p> <p><b>Art. 6610</b>            1 pz = 1  - kg 0,9/ m³ 0,004            1 pz = 1  - kg 3/ m³ 0,032</p> <p><b>Art. 6611</b>            1 pz = 1  - kg 19/ m³ 0,25</p>		
<p><b>FIRE RETARDANT TEST</b></p>		



# SOFAS AND BENCHES



## Sofas and Benches

Sofas Arper Grade	Supplier	Collection	Upholstery Code	Program
A	Camira	Era	ER	Graded In
A	Camira	Phoenix	PH	Carded In
A	FiDiVi.	Jet	JE	Carded In
A	Gabriel	Fighter	FH	Graded In
B	Camira	Urban	UP	Carded In
B	Camira	Xtreme	XP	Graded In
B	Gabriel	Atlantic	AT	Graded In
B	Gabriel	Medley	MY	Graded In
B	Gabriel	Step	S1	Graded In
B	Gabriel	Step Melange	SM	Graded In
B	Kvadrat	Revive 1	R1	Carded In
B	Spradling	Silvertex – Outdoor	SX	Carded In
B	Spradling	Valencia Coated Fabric	VL	Carded In
C	Camira	Main Line Flax	MF	Carded In
C	Camira	Synergy	SN	Carded In
C	Gabriel	Fame	FA	Graded In
C	Kvadrat	Field 2	FI	Carded In
C	Kvadrat	Floyd	F1	Carded In
C	Sunbrella	Heritage – Outdoor	HE	Carded In
C	Sunbrella	Savane – Outdoor	SV	Carded In
D	Camira	Blazer	BL	Graded In
D	Gabriel	Crisp	CR	Graded In
D	Kvadrat	Patio – Outdoor	PT	Carded In
D	Kvadrat	Remix 3	RX	Carded In
D	Maharam	Messenger	MS	Carded In
E	Kvadrat	Clara 2	CL	Graded In
E	Kvadrat	Re-wool	RW	Carded In
ES	Elmo Leather	Elmosoft Leather	ES	Carded In

## Sofas and Benches

Sofas Arper Grade	Supplier	Collection	Upholstery Code	Program
F	Kvadrat	Canvas 2	CV	Carded In
F	Kvadrat	Fiord 2	FD	Carded In
G	Kvadrat	Hallingdal 65	HA	Carded In
G	Kvadrat	Jaali	JA	Carded In
G	Kvadrat	Savanna	SA	Graded In
G	Kvadrat	Tonus 4	T3	Carded In
H	Elmo Leather	Neocoast Leather	P4	Carded In
H	Kvadrat	Steelcut 2	SE	Carded In
H	Kvadrat	Steelcut Trio 3	ST	Carded In
I	Arper	Pelle fiore Leather	PF	Carded In
I	Kvadrat	Balder 3	B1	Carded In
I	Kvadrat	Divina 3	DV	Carded In
I	Kvadrat	Divina MD	DI	Carded In
I	Kvadrat	Divina Melange 3	DM	Carded In
I	Kvadrat	Tonica 2	TN	Graded In
J	Kvadrat	Vidar 4	VD	Carded In
COL		COL	COL	
COM		COM	COM	



# ARCOS

---

Design by  
Lievore Altherr  
2017



# Arcos

## Collection overview

---

### Type



---

Chair

Armchair



---

2 seat sofa



---

3 seat sofa

### Options



---

— Upholstered  
armrest pad



USB

## Types of Upholstery

Color is one of the main characteristics of the Arcos collection, consisting of chairs, armchairs and sofas conceived for home and contract spaces. In addition to the more traditional finishes, such as powder-coated black aluminium, the sled base and integrated armrests are available in four additional powder-coated aluminium finishes: blue, green, red earth and yellow ochre.

The aesthetic qualities of the product are enhanced through the chromatic balance between the color of the sled base and the upholstery. For this reason we suggest:

## Frame Base



V62 matt  
NCS S 5040-Y10R



KVADRAT  
Remix 3  
RX00422  
Grade:  
Chairs C  
Sofas D



KVADRAT  
Canvas 2  
CV00424  
Grade:  
Chairs D  
Sofas F



KVADRAT  
Steelcut Trio 3  
ST00466  
Grade:  
Chairs G  
Sofas H



ELMO  
Elmosoft  
ES43054  
Grade:  
Chairs ES  
Sofas ES



V60 matt  
NCS S 7020-G10Y



SPRADLING  
Valencia  
VL05069  
Grade:  
Chairs B  
Sofas B



KVADRAT  
Remix 3  
RX00982  
Grade:  
Chairs C  
Sofas D

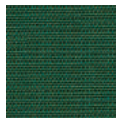

KVADRAT  
Canvas 2  
CV00946  
Grade:  
Chairs D  
Sofas F



KVADRAT  
Hallingdal 65  
HA00944  
Grade:  
Chairs G  
Sofas G



ELMO  
Elmosoft  
ES98015  
Grade:  
Chairs ES  
Sofas ES



V61 matt  
NCS S 5040-Y70R



KVADRAT  
Remix 3  
RX00443  
Grade:  
Chairs C  
Sofas D



KVADRAT  
Canvas 2  
CV00454  
Grade:  
Chairs D  
Sofas F

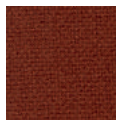

KVADRAT  
Tonus 4  
T300474  
Grade:  
Chairs F  
Sofas G

# Arcos



V59 matt  
NCS S 8010-R70B

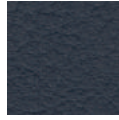

SPRADLING  
Valencia  
VL03068  
Grade:  
Chairs B  
Sofas B



KVADRAT  
Remix 3  
RX00773  
Grade:  
Chairs C  
Sofas D

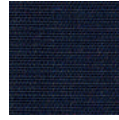

KVADRAT  
Canvas 2  
CV00786  
Grade:  
Chairs D  
Sofas F

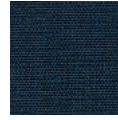

KVADRAT  
Canvas 2  
CV00794  
Grade:  
Chairs D  
Sofas F



KVADRAT  
Hallingdal 65  
HA00764  
Grade:  
Chairs G  
Sofas G



KVADRAT  
Steelcut Trio 3  
ST00796  
Grade:  
Chairs G  
Sofas H

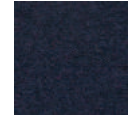

KVADRAT  
Divina MD  
DI00783  
Grade:  
Chairs G  
Sofas I



ELMO  
Elmosoft  
ES77127  
Grade:  
Chairs ES  
Sofas ES



V39 matt

The powder-coated black aluminium finish is suitable for matching with all fabrics and leathers, in all shades of color.

# Arcos Chair

Design by Lievore Altherr, 2017

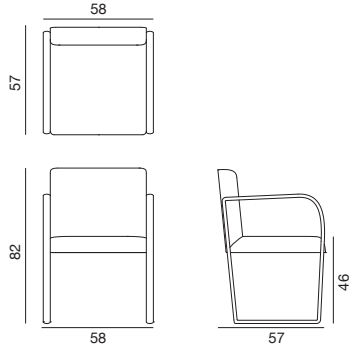

Chair with sled base and integrated armrests made of powder-coated aluminum. Shell in metal and plywood is upholstered in leather, coated fabric, fabric or customer's material. Arper grade: CHAIR

Accessories:  
 USB Art. 6001  
 Replacement cover set Art. 6103

SEK ART. 6100	A	B COM	C COL	D	E	F	G	H	I	J	K	L	M	ES
POWDERCOATED	11753	12253	12753	13253	13753	14253	14753	15253	15753	16253	16753	17253	17753	19599
Removable version	+ 702													
SHIPMENT DETAILS	TECHNICAL SPECIFICATIONS				RESISTANCE TEST									
<b>Art.6100</b> 1 pz = 1  - kg 13/ m² 0,352	<b>Art.6100</b> COL requirement m² 2.4 H 140 cm. COM Meterage m 1.52 *Classe 1, 2, 1IM: fire retardant version available with surcharge and eventual minimum batch				<ul style="list-style-type: none"> <li>• EN 1728:2012 - EN 16139:2013 6.10</li> <li>• EN 1728:2012 - EN 16139:2013 6.15</li> <li>• EN 1728:2012 - EN 16139:2013 6.17</li> <li>• EN 1728:2012 - EN 16139:2013 6.20</li> <li>• EN 1728:2012 - EN 16139:2013 6.25</li> <li>• EN 1728:2012 - EN 16139:2013 6.4</li> <li>• EN 1728:2012 - EN 16139:2013 6.6</li> </ul>					<ul style="list-style-type: none"> <li>• EN 1728:2012 - EN 16139:2013 6.11</li> <li>• EN 1728:2012 - EN 16139:2013 6.16</li> <li>• EN 1728:2012 - EN 16139:2013 6.18</li> <li>• EN 1728:2012 - EN 16139:2013 6.24</li> <li>• EN 1728:2012 - EN 16139:2013 6.26</li> <li>• EN 1728:2012 - EN 16139:2013 6.5</li> <li>• EN 1728:2012 - EN 16139:2013 6.13.1</li> </ul>				
FIRE RETARDANT TEST														
• FIRE RETARDANT VERSION WITH SURCHARGE * Classe 1IM Omologazione Italia Canvas 2 Kvadrat. Remix 3 Kvadrat.														

## Frame Base

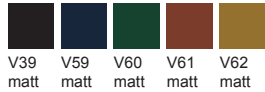



# Arcos

Design by Lievore Altherr, 2017



Armchair with sled base and integrated armrests made of powder-coated aluminum. Shell in metal and plywood is upholstered in leather, coated fabric, fabric or customer's material. Arper Grade: SOFA.

Accessories:  
 USB Art. 6001  
 Replacement cover set Art. 6104

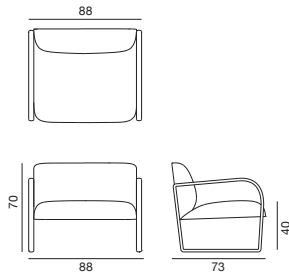

SEK ART. 6101	A	B	COM	C	COL	D	E	F	G	H	I	J	K	L	M	ES
POWDERCOATED	17265	18099	18933	19767	20601	21435	22269	23103	23937	24771	25605	26439	27273	30732		
Removable version	+ 1191															
Armrests CI - only pad	+ 1131															

SHIPMENT DETAILS	TECHNICAL SPECIFICATIONS	RESISTANCE TEST
<b>Art. 6101</b> 1 pz = 1  - kg 27,96/ m³ 0,901	<b>Art.6101</b> COL requirement m² 5.46 H 140 cm. COM Meterage m 2.48 *Classe 1, 2, 1IM: fire retardant version available with surcharge and eventual minimum batch	
<b>FIRE RETARDANT TEST</b> • FIRE RETARDANT VERSION WITH SURCHARGE * Classe 1IM Omologazione Italia Canvas 2 Kvadrat. Remix 3 Kvadrat.		

## Frame Base



## Armrest



Armrests CI - only pad



# Arcos

Design by Lievore Altherr, 2017



Two seater sofa with sled base and integrated armrests made of powder-coated aluminum. Shell in metal and plywood is upholstered in leather, coated fabric, fabric or customer's material. Arper Grade: SOFA.

Accessories:  
 USB Art. 6001  
 Replacement cover set Art. 6105

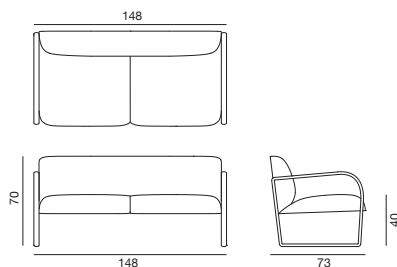

SEK ART. 6102	A	B COM	C COL	D	E	F	G	H	I	J	K	L	M	ES
POWDERCOATED	24826	26100	27374	28648	29922	31196	32470	33744	35018	36292	37566	38840	40114	45033
Removable version	+ 1965													
Armrests CI - only pad	+ 1131													

SHIPMENT DETAILS	TECHNICAL SPECIFICATIONS	RESISTANCE TEST
<b>Art. 6102</b> 1 pz = 1  - kg 27/ m³ 1,063	<b>Art.6102</b> COL requirement m² 9.1 H 140 cm. COM Meterage m 4.08 *Classe 1, 2, 1IM: fire retardant version available with surcharge and eventual minimum batch	<ul style="list-style-type: none"> <li>• EN 1728:2012 - EN 16139:2013 6.10</li> <li>• EN 1728:2012 - EN 16139:2013 6.15</li> <li>• EN 1728:2012 - EN 16139:2013 6.17</li> <li>• EN 1728:2012 - EN 16139:2013 6.20</li> <li>• EN 1728:2012 - EN 16139:2013 6.25</li> <li>• EN 1728:2012 - EN 16139:2013 6.4</li> <li>• EN 1728:2012 - EN 16139:2013 6.6</li> </ul> <ul style="list-style-type: none"> <li>• EN 1728:2012 - EN 16139:2013 6.11</li> <li>• EN 1728:2012 - EN 16139:2013 6.16</li> <li>• EN 1728:2012 - EN 16139:2013 6.18</li> <li>• EN 1728:2012 - EN 16139:2013 6.24</li> <li>• EN 1728:2012 - EN 16139:2013 6.26</li> <li>• EN 1728:2012 - EN 16139:2013 6.5</li> <li>• EN 1728:2012 - EN 16139:2013 6.27.1</li> </ul>
<b>FIRE RETARDANT TEST</b> • FIRE RETARDANT VERSION WITH SURCHARGE * Classe 1IM Omologazione Italia Canvas 2 Kvadrat. Remix 3 Kvadrat.		

Frame Base

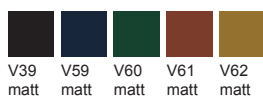

Armrest



Armrests CI - only pad



# Arcos

Design by Lievore Altherr, 2018



Three seater sofa with sled base and integrated armrests made of powder-coated aluminum. Shell in metal and plywood frame is upholstered in fabric, leather, coated fabric or customer's fabric or leather. Arper Grade: SOFA.

Accessories:  
 USB Art. 6001  
 Replacement cover set Art. 6107

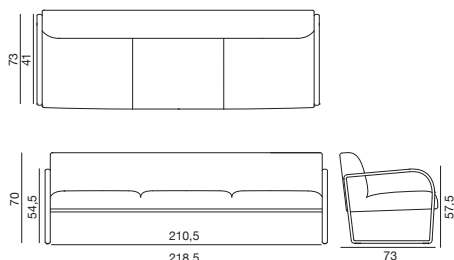

SEK ART. 6106	A	B	COM	C	COL	D	E	F	G	H	I	J	K	L	M	ES
POWDERCOATED	30732	32637	34542	36447	38352	40257	42162	44067	45972	47877	49782	51687	53592	61023		
Removable version	+ 3083															
Armrests CI - only pad	+ 1131															

SHIPMENT DETAILS	TECHNICAL SPECIFICATIONS	RESISTANCE TEST
<b>Art. 6106</b> 1 pz = 1  - kg 50/ m³ 1,535	<b>Art.6106</b> COL requirement m² 16.1 H 140 cm. COM Meterage m 5.32 *Classe 1, 2, 1IM: fire retardant version available with surcharge and eventual minimum batch	<ul style="list-style-type: none"> <li>• EN 1728:2012 - EN 16139:2013 6.10</li> <li>• EN 1728:2012 - EN 16139:2013 6.15</li> <li>• EN 1728:2012 - EN 16139:2013 6.17</li> <li>• EN 1728:2012 - EN 16139:2013 6.20</li> <li>• EN 1728:2012 - EN 16139:2013 6.25</li> <li>• EN 1728:2012 - EN 16139:2013 6.4</li> <li>• EN 1728:2012 - EN 16139:2013 6.6</li> </ul> <ul style="list-style-type: none"> <li>• EN 1728:2012 - EN 16139:2013 6.11</li> <li>• EN 1728:2012 - EN 16139:2013 6.16</li> <li>• EN 1728:2012 - EN 16139:2013 6.18</li> <li>• EN 1728:2012 - EN 16139:2013 6.24</li> <li>• EN 1728:2012 - EN 16139:2013 6.26</li> <li>• EN 1728:2012 - EN 16139:2013 6.5</li> <li>• EN 1728:2012 - EN 16139:2013 6.27.1</li> </ul>
<b>FIRE RETARDANT TEST</b> Classe 1IM Omologazione Italia Remix 3 Kvadrat. • FIRE RETARDANT VERSION WITH SURCHARGE * Classe 1IM Omologazione Italia Canvas 2 Kvadrat. Remix 3 Kvadrat.		

Frame Base

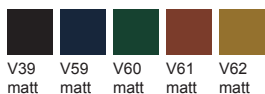

Armrest



Armrests CI - only pad



# Accessories

Design by Lievore Altherr, 2017

<b>SEK ART. 6103</b>	A	B COM	C COL	D	E	F	G	H	I	J	K	L	M	ES
SPARE COVER ART. 6100	1858	2358	2858	3358	3858	4358	4858	5358	5858	6358	6858	7358	7858	9704
<b>SEK ART. 6104</b>	A	B COM	C COL	D	E	F	G	H	I	J	K	L	M	ES
SPARE COVER ART. 6101	2488	3322	4156	4990	5824	6658	7492	8326	9160	9994	10828	11662	12496	15956
<b>SEK ART. 6105</b>	A	B COM	C COL	D	E	F	G	H	I	J	K	L	M	ES
SPARE COVER ART. 6102	4620	5894	7168	8442	9716	10990	12264	13538	14812	16086	17360	18634	19908	24802
<b>SEK ART. 6107</b>	A	B COM	C COL	D	E	F	G	H	I	J	K	L	M	ES
SPARE COVER ART. 6106	4632	6537	8442	10347	12252	14157	16062	17967	19872	21777	23682	25587	27492	34935

SHIPMENT DETAILS	TECHNICAL SPECIFICATIONS	RESISTANCE TEST
<p><b>Art. 6107</b> 1 pz = 1  - kg 5/ m² 0,036</p>	<p><b>Art.6103</b> COL requirement m² 2.4 H 140 cm. COM Meterage m 1.52</p> <p><b>Art.6104</b> COL requirement m² 5.46 H 140 cm. COM Meterage m 2.48</p> <p><b>Art.6105</b> COL requirement m² 9.1 H 140 cm. COM Meterage m 4.08</p> <p><b>Art.6107</b> COL requirement m² 16.1 H 140 cm. COM Meterage m 5.32</p>	
<b>FIRE RETARDANT TEST</b>		



## Accessories

### **SEK ART. 6001**



Power supply kit consisting of 2 units with 2 USB A sockets each, 1 power supply unit and cable clamps. Electric cable not included.

1655

SHIPMENT DETAILS	TECHNICAL SPECIFICATIONS	RESISTANCE TEST
<b>FIRE RETARDANT TEST</b>		



# COLINA

---

Design by  
Lievore Altherr Molina  
2014



# Colina

## Collection overview

---

### Type



Armchair S



Armchair M



Armchair L

---



Armchair sled

---



Armchair 4 legs

---

# Colina S

Design by Lievore Altherr Molina, 2014

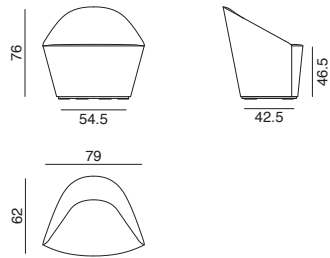

Armchair with plywood frame fully upholstered in fabric, leather, coated fabric or customer's own material. The version with removable cover is available upon request. Optional glides with felt for wooden floors are available upon request.

Accessories:  
Replacement cover set Art. 4307

SEK ART. 4300	A	B COM	C COL	D	E	F	G	H	I	J	K	L	M	ES
	13241	14205	15169	16133	17097	18061	19025	19989	20953	21917	22881	23845	24809	29089
Removable cover	+ 441													
SHIPMENT DETAILS	TECHNICAL SPECIFICATIONS				RESISTANCE TEST									
<b>Art.4300</b> 1 pz = 1  - kg 32,36/ m³ 0,662	<b>Art.4300</b> COL requirement m² 4.8 H 140 cm. COM Meterage m 2.92 *Classe 1, 2, 1IM: fire retardant version available with surcharge and eventual minimum batch													
FIRE RETARDANT TEST														
Classe 1IM Omologazione Italia Divina MD Kvadrat. Divina Melange 3 Kvadrat. Divina 3 Kvadrat. Steelcut Trio 3 Kvadrat. Coated fabric Valencia Spradling. • FIRE RETARDANT VERSION WITH SURCHARGE * Classe 1IM Omologazione Italia Remix 3 Kvadrat.														





# Colina M

Design by Lievore Altherr Molina, 2014

Armchair with plywood frame fully upholstered in fabric, leather, coated fabric or customer's own material. The version with removable cover is available upon request. Optional glides with felt for wooden floors are available upon request.

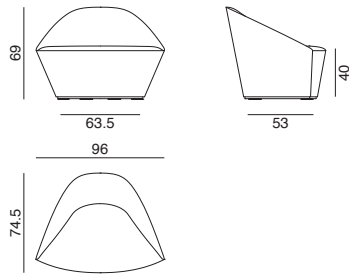

Accessories:  
Replacement cover set Art. 4308

SEK ART. 4301	A	B COM	C COL	D	E	F	G	H	I	J	K	L	M	ES
	15455	16621	17787	18953	20119	21285	22451	23617	24783	25949	27115	28281	29447	34280
Removable cover	+ 798													

SHIPMENT DETAILS	TECHNICAL SPECIFICATIONS	RESISTANCE TEST
<b>Art.4301</b> 1 pz = 1  - kg 39,06/ m² 0,901	<b>Art.4301</b> COL requirement m² 5.52 H 140 cm. COM Meterage m 3.47 *Classe 1, 2, 1IM: fire retardant version available with surcharge and eventual minimum batch	

**FIRE RETARDANT TEST**  
 Classe 1IM Omologazione Italia Divina MD Kvadrat. Divina Melange 3 Klasse 3 Kvadrat. Steelcut Trio 3 Kvadrat. Coated fabric Valencia Spradling.  
 • FIRE RETARDANT VERSION WITH SURCHARGE • Classe 1IM Omologazione Italia Remix 3 Kvadrat.



# Colina L

Design by Lievore Altherr Molina, 2014

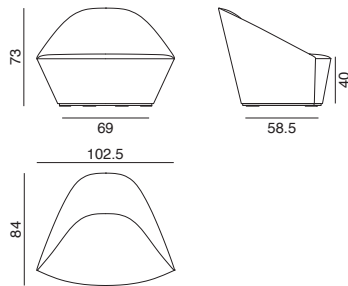

Armchair with plywood frame fully upholstered in fabric, leather, coated fabric or customer's own material. The version with removable cover is available upon request. Optional glides with felt for wooden floors are available upon request.

Accessories:  
Replacement cover set Art. 4309

SEK ART. 4302	A	B COM	C COL	D	E	F	G	H	I	J	K	L	M	ES
	17432	18742	20052	21362	22672	23982	25292	26602	27912	29222	30532	31842	33152	38733
Removable cover	+ 881													
SHIPMENT DETAILS	TECHNICAL SPECIFICATIONS				RESISTANCE TEST									
<b>Art.4302</b> 1 pz = 1  - kg 43,96/ m³ 0,901	<b>Art.4302</b> COL requirement m² 6.12 H 140 cm. COM Meterage m 3.91 *Classe 1, 2, 1IM: fire retardant version available with surcharge and eventual minimum batch				<ul style="list-style-type: none"> <li>• EN 1728:2012 - EN 16139:2013 6.10</li> <li>• EN 1728:2012 - EN 16139:2013 6.17</li> <li>• EN 1728:2012 - EN 16139:2013 6.20</li> <li>• EN 1728:2012 - EN 16139:2013 6.25</li> <li>• EN 1728:2012 - EN 16139:2013 6.4</li> </ul>					<ul style="list-style-type: none"> <li>• EN 1728:2012 - EN 16139:2013 6.11</li> <li>• EN 1728:2012 - EN 16139:2013 6.18</li> <li>• EN 1728:2012 - EN 16139:2013 6.24</li> <li>• EN 1728:2012 - EN 16139:2013 6.26</li> <li>• EN 1728:2012 - EN 16139:2013 6.5</li> </ul>				
FIRE RETARDANT TEST														
Classe 1IM Omologazione Italia Divina MD Kvadrat. Divina Melange 3 Kvadrat. Divina 3 Kvadrat. Steelcut Trio 3 Kvadrat. Coated fabric Valencia Spradling. • FIRE RETARDANT VERSION WITH SURCHARGE * Classe 1IM Omologazione Italia Remix 3 Kvadrat.														



# Colina M

Design by Lievore Altherr Molina, 2014

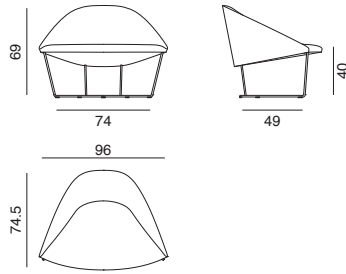

Armchair with plywood frame fully upholstered in fabric, leather, coated fabric or customer's own material. Base available in chromed or anthracite powder-coated steel. The version with removable cover is available upon request. Optional glides with felt for wooden floors are available upon request.

Accessories:  
Replacement cover set Art. 4310  
USB Art. 6001

SEK ART. 4303	A	B COM	C COL	D	E	F	G	H	I	J	K	L	M	ES
CHROMED / POWERCOATED	15824	16490	17156	17822	18488	19154	19820	20486	21152	21818	22484	23150	23816	26695
Removable cover	+ 798													

SHIPMENT DETAILS	TECHNICAL SPECIFICATIONS	RESISTANCE TEST
<b>Art.4303</b> 1 pz = 1  - kg 27,96/ m² 0,901	<b>Art.4303</b> COL requirement m² 4.38 H 140 cm. COM Meterage m 1.98 *Classe 1, 2, 1IM: fire retardant version available with surcharge and eventual minimum batch	<ul style="list-style-type: none"> <li>• EN 1728:2012 - EN 16139:2013 6.10</li> <li>• EN 1728:2012 - EN 16139:2013 6.15</li> <li>• EN 1728:2012 - EN 16139:2013 6.18</li> <li>• EN 1728:2012 - EN 16139:2013 6.4</li> </ul> <ul style="list-style-type: none"> <li>• EN 1728:2012 - EN 16139:2013 6.11</li> <li>• EN 1728:2012 - EN 16139:2013 6.17</li> <li>• EN 1728:2012 - EN 16139:2013 6.20</li> <li>• EN 1728:2012 - EN 16139:2013 6.5</li> </ul>

**FIRE RETARDANT TEST**  
 Classe 1IM Omologazione Italia Divina MD Kvadrat. Divina Melange 3 Kvadrat. Divina 3 Kvadrat. Steelcut Trio 3 Kvadrat. Coated fabric Valencia Spradling.  
 \* FIRE RETARDANT VERSION WITH SURCHARGE \* Classe 1IM Omologazione Italia Remix 3 Kvadrat.

Frame Base



# Colina M

Design by Lievore Altherr Molina, 2014

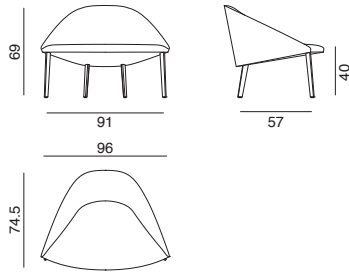

Armchair with plywood frame fully upholstered in fabric, leather, coated fabric or customer's own material. Oak timber four-leg base available in 2 finishes. The version with removable cover is available upon request. Optional glides with felt for wooden floors are available upon request.

Accessories:  
Replacement cover set Art. 4309  
USB Art. 6001

SEK ART. 4304	A	B COM	C COL	D	E	F	G	H	I	J	K	L	M	ES
WOOD LEGS	17205	17871	18537	19203	19869	20535	21201	21867	22533	23199	23865	24531	25197	28101
Removable cover	+ 798													

SHIPMENT DETAILS	TECHNICAL SPECIFICATIONS	RESISTANCE TEST
<b>Art. 4304</b> 1 pz = 1  - kg 27,06/ m³ 0,901	<b>Art. 4304</b> COL requirement m² 4.38 H 140 cm. COM Meterage m 1.98 *Classe 1, 2, 1IM: fire retardant version available with surcharge and eventual minimum batch	<ul style="list-style-type: none"> <li>• EN 1728:2012 - EN 16139:2013 6.10</li> <li>• EN 1728:2012 - EN 16139:2013 6.15</li> <li>• EN 1728:2012 - EN 16139:2013 6.17</li> <li>• EN 1728:2012 - EN 16139:2013 6.20</li> <li>• EN 1728:2012 - EN 16139:2013 6.25</li> <li>• EN 1728:2012 - EN 16139:2013 6.4</li> </ul> <ul style="list-style-type: none"> <li>• EN 1728:2012 - EN 16139:2013 6.11</li> <li>• EN 1728:2012 - EN 16139:2013 6.16</li> <li>• EN 1728:2012 - EN 16139:2013 6.18</li> <li>• EN 1728:2012 - EN 16139:2013 6.24</li> <li>• EN 1728:2012 - EN 16139:2013 6.26</li> <li>• EN 1728:2012 - EN 16139:2013 6.5</li> </ul>
<b>FIRE RETARDANT TEST</b> Classe 1IM Omologazione Italia Divina MD Kvadrat. Divina Melange 3 Kvadrat. Divina 3 Kvadrat. Steelcut Trio 3 Kvadrat. Coated fabric Valencia Spradling. * FIRE RETARDANT VERSION WITH SURCHARGE * Classe 1IM Omologazione Italia Remix 3 Kvadrat.		



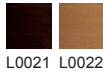

Frame Base



# Accessories

Design by Lievore Altherr Molina, 2014

<b>SEK ART. 4307</b>	A	B COM	C COL	D	E	F	G	H	I	J	K	L	M	ES
SPARE COVER ART. 4300	3000	3964	4928	5892	6856	7820	8784	9748	10712	11676	12640	13604	14568	18873
<b>SEK ART. 4308</b>	A	B COM	C COL	D	E	F	G	H	I	J	K	L	M	ES
SPARE COVER ART. 4301	3441	4607	5773	6939	8105	9271	10437	11603	12769	13935	15101	16267	17433	22243
<b>SEK ART. 4309</b>	A	B COM	C COL	D	E	F	G	H	I	J	K	L	M	ES
SPARE COVER ART. 4302	3632	4942	6252	7562	8872	10182	11492	12802	14112	15422	16732	18042	19352	24957
<b>SEK ART. 4310</b>	A	B COM	C COL	D	E	F	G	H	I	J	K	L	M	ES
SPARE COVER ART. 4303/4304	2822	3488	4154	4820	5486	6152	6818	7484	8150	8816	9482	10148	10814	13729

SHIPMENT DETAILS	TECHNICAL SPECIFICATIONS	RESISTANCE TEST
<b>Art. 4307</b> 1 pz = 1  - kg 5/ m³ 0,036 <b>Art. 4308</b> 1 pz = 1  - kg 5/ m³ 0,036 <b>Art. 4309</b> 1 pz = 1  - kg 5/ m³ 0,036 <b>Art. 4310</b> 1 pz = 1  - kg 5/ m³ 0,036	<b>Art.4307</b> COL requirement m² 4.8 H 140 cm. COM Meterage m 2.92 <b>Art.4308</b> COL requirement m² 5.52 H 140 cm. COM Meterage m 3.47 <b>Art.4309</b> COL requirement m² 6.12 H 140 cm. COM Meterage m 3.91 <b>Art.4310</b> COL requirement m² 4.38 H 140 cm. COM Meterage m 1.98	
<b>FIRE RETARDANT TEST</b>		



# KIHK

Design by Ichiro Iwasaki

2018

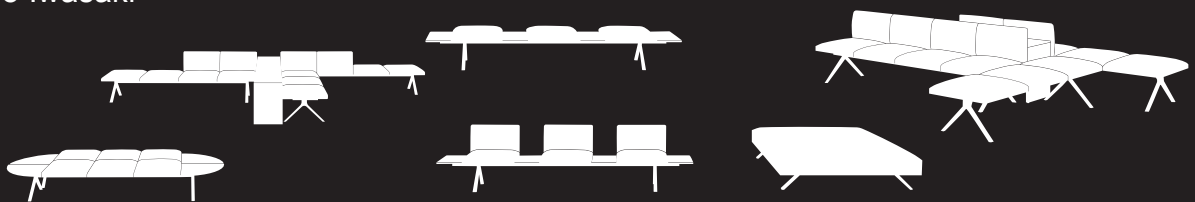

## Collection overview

(For more information please refer to User's Manual downloadable from our website)

---

### Structure

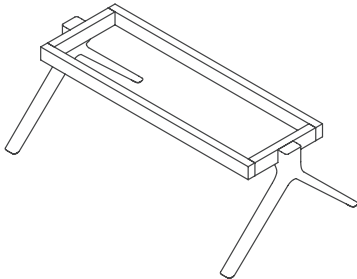

---

Art. 6302 – S126

- Dimensions: 100x58x35,5 cm
- Dimensions of complete item: 126x63 cm
- Fills 2 units

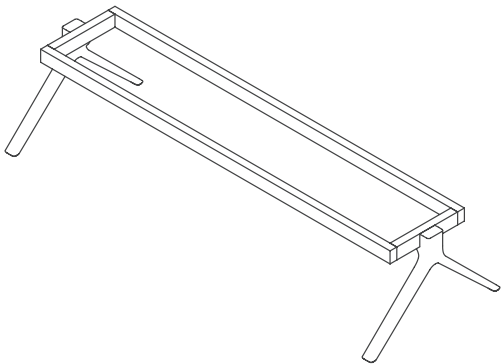

---

Art. 6301 – S189

- Dimensions: 163x58x35,5 cm
- Dimensions of complete item: 189x63 cm
- Fills 3 units

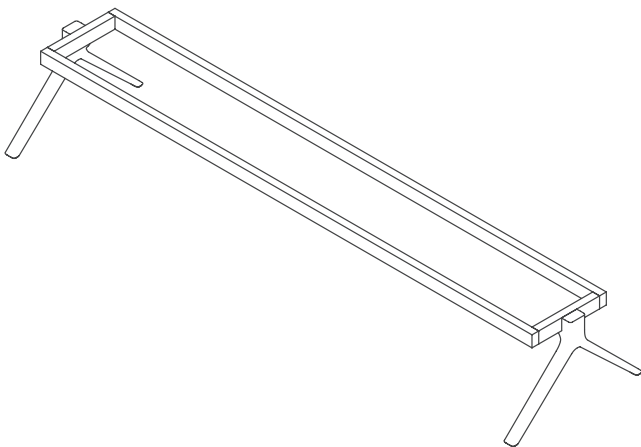

---

Art. 6300 – S252

- Dimensions: 226x58x35,5 cm
- Dimensions of complete item: 252x63 cm
- Fills 4 units

Structure



V39 - matt

Legs



V39 - matt

## Seating modules

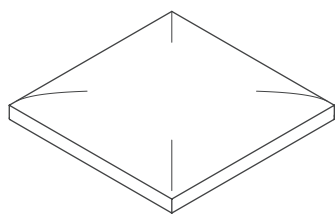

Art. 6303 – Cushion  
— Dimension: 63x63x10 cm  
— Fills 1 unit

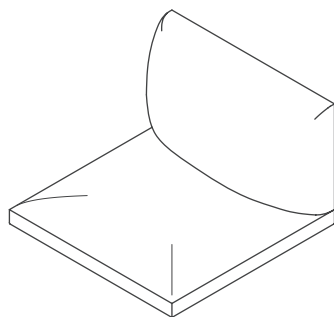

Art. 6304 – Cushion with standard backrest  
— Dimension: 63x63x40 cm  
— Fills 1 unit

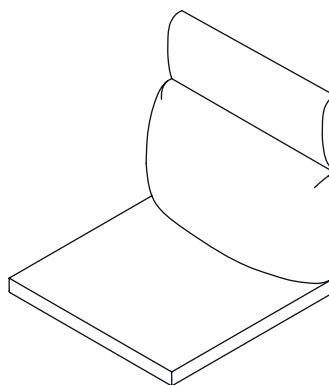

Art. 6332 – Cushion with high backrest  
— Dimension: 63x63x60 cm  
— Fills 1 unit

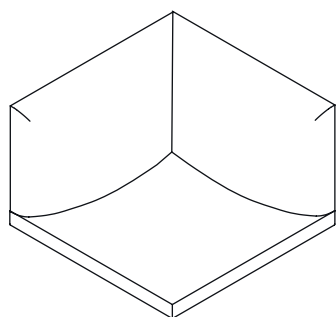

Art. 6328 / 6329 – Angular cushion with standard backrest  
— Dimension: 63x63x40 cm  
— Fills 1 unit

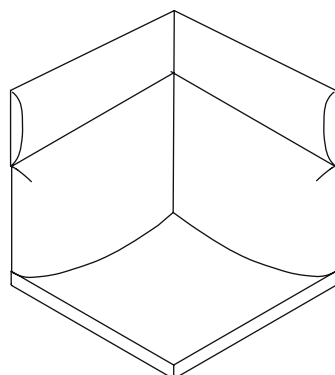

Art. 6330 / 6331 – Angular cushion with high backrest  
— Dimension: 63x63x60 cm  
— Fills 1 unit



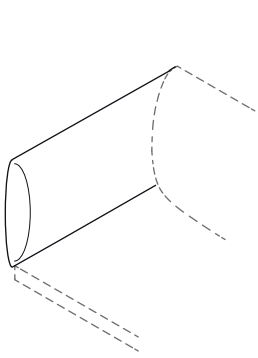

Art. 6334/6335 – Side armrest

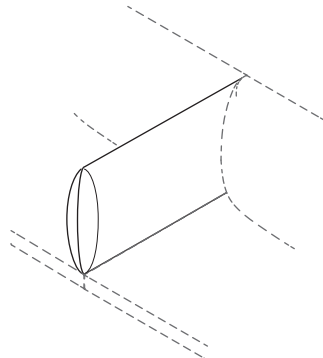

Art. 6333 – Middle armrest

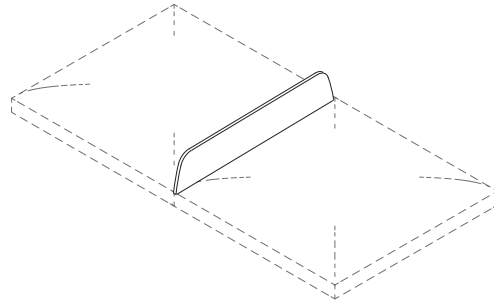

Art. 6336 — Separator between seats

## Table modules

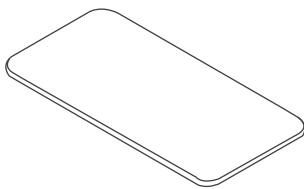

Art. 6310 – Rectangular side table  
— Dimension: 31,5x63 cm  
— Thick: 1,4 cm  
— Fills 0,5 unit

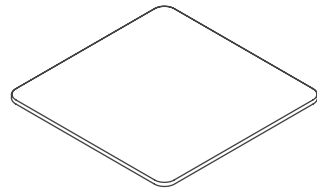

Art. 6309 – Square side table  
— Dimension: 63x63 cm  
— Thick: 1,4 cm  
— Fills 1 unit

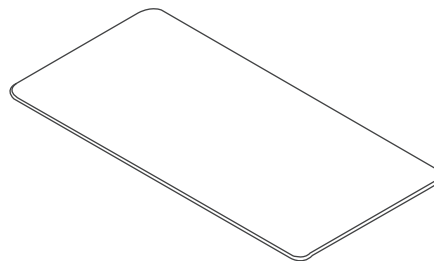

Art. 6308 – Rectangular side table  
— Dimension: 126x63 cm  
— Thick: 1,4 cm  
— Fills 2 units

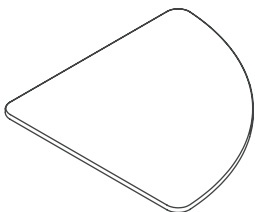

Art. 6311 – Quarter round side table  
— Dimension: 63x63 cm  
— Thick: 1,4 cm  
— For compositions with 90° corner

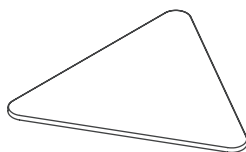

Art. 6312 – Triangular side table  
— Dimension: 63x63x63 cm  
— Thick: 1,4 cm  
— For compositions with 120° corner



LM13



LM00022

---

**Console**

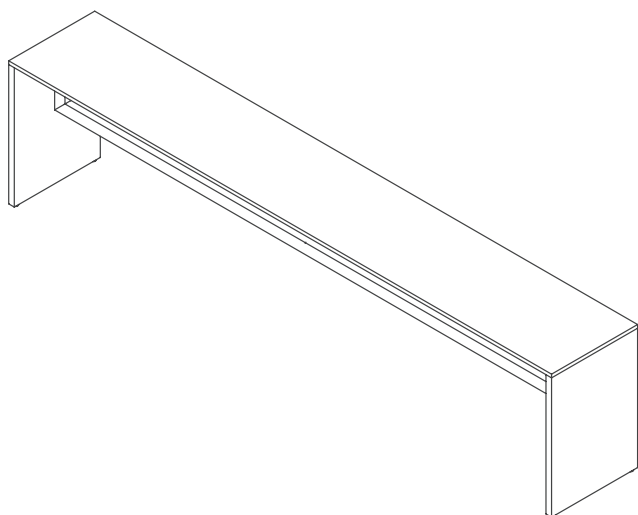

Art. 6305 – Console h 58 cm  
— Dimensions: 252x40x58 cm

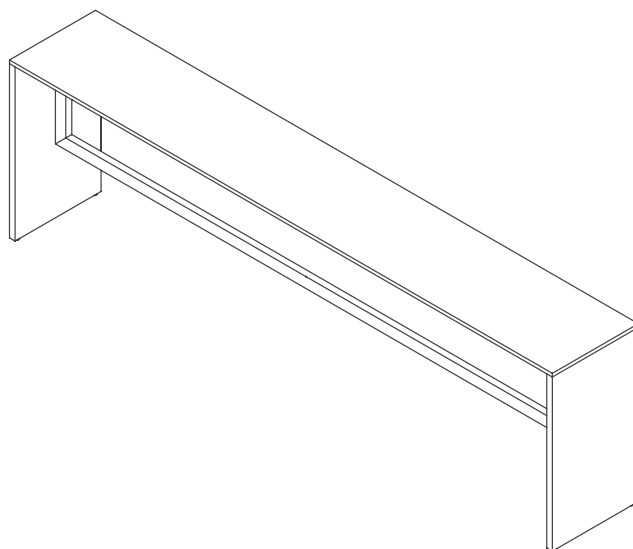

Art. 6306 – Console h. 72 cm  
— Dimensions: 252x40x72 cm

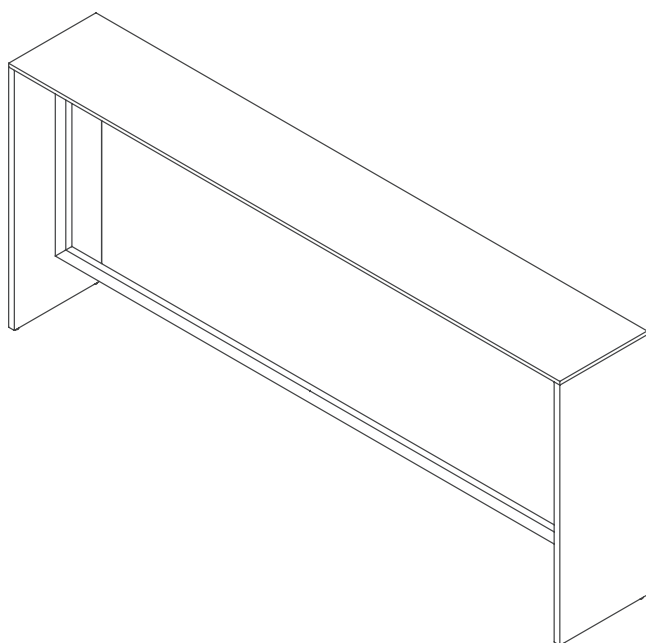

Art. 6307 – Console h. 105cm  
— Dimensions: 252x40x105 cm

---

## Ottoman

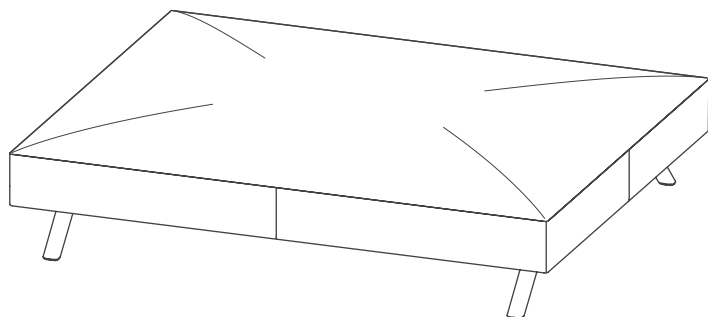

---

Art. 6313 – Ottoman  
— Dimensions: 126x157,5x36 cm



V39 - matt

---

## Link

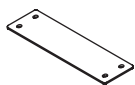

---

Art. 6316 – Plate-shaped  
link  
— Dimensions: 26,6x8 cm

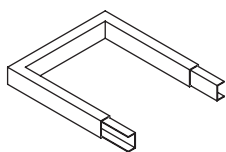

Art. 6314 – C-shaped link  
— Dimensions: 31x33x5 cm

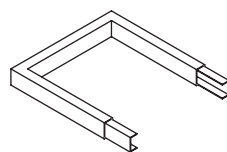

Art. 6315 – Island-shaped link  
— Dimensions:  
33,4x36x5 cm



V39 - matt

**Options**



---

USB

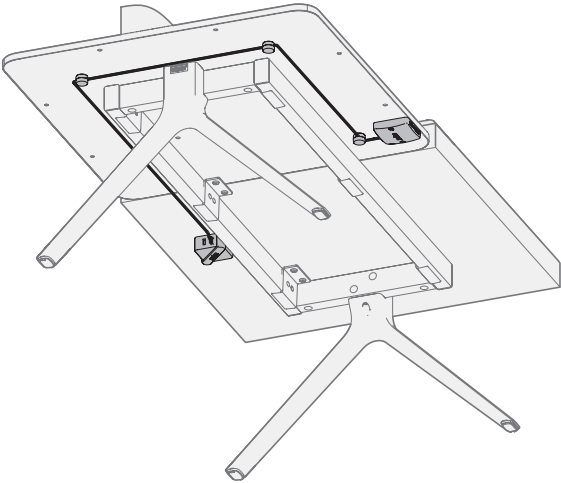

Composition Examples

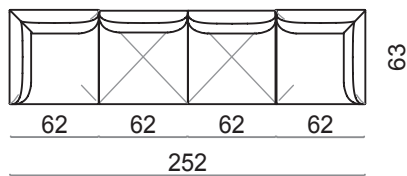
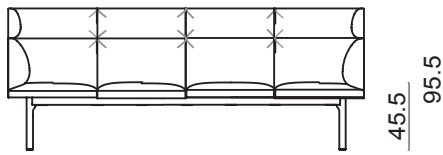
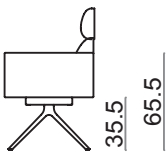
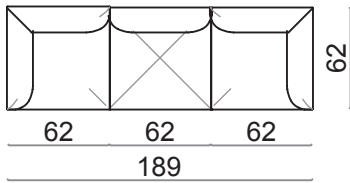
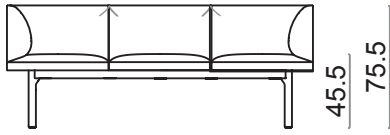
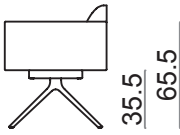
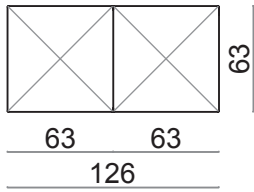
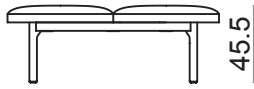



- 
- 1 x Art. 6300 – Structure S252
  - 3 x Art. 6304 – Cushion with backrest
  - 4 x Art. 6310 – Rectangular table 31,5x63 cm
  - 2 x Art. 6314 – C-shaped link

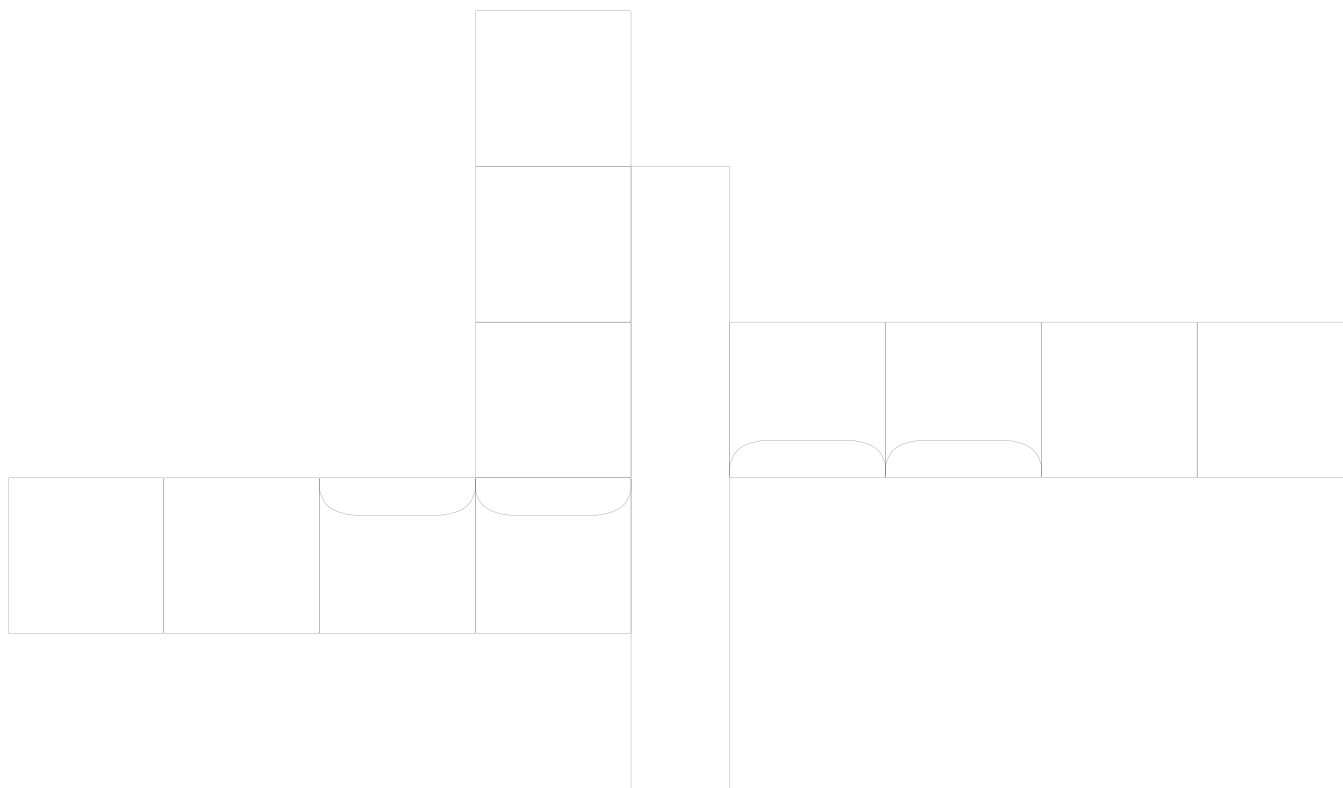

- 
- 2 x Art. 6300 – Structure S252
  - 1 x Art. 6301 – Structure S189
  - 7 x Art. 6303 – Cushion
  - 4 x Art. 6304 – Cushion with backrest
  - 1 x Art. 6305 – Console h 58 cm
  - 1 x Art. 6316 – Plate-shaped link

# Kiik

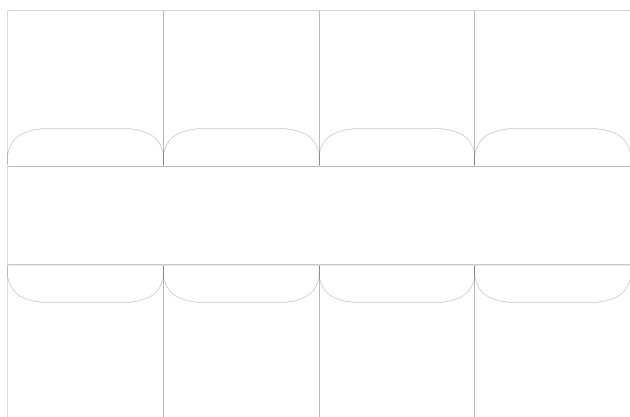

- 
- 2 x Art. 6300 – Structure S252
  - 8 x Art. 6304 – Cushion with backrest
  - 1 x Art. 6306 – Console h 72 cm

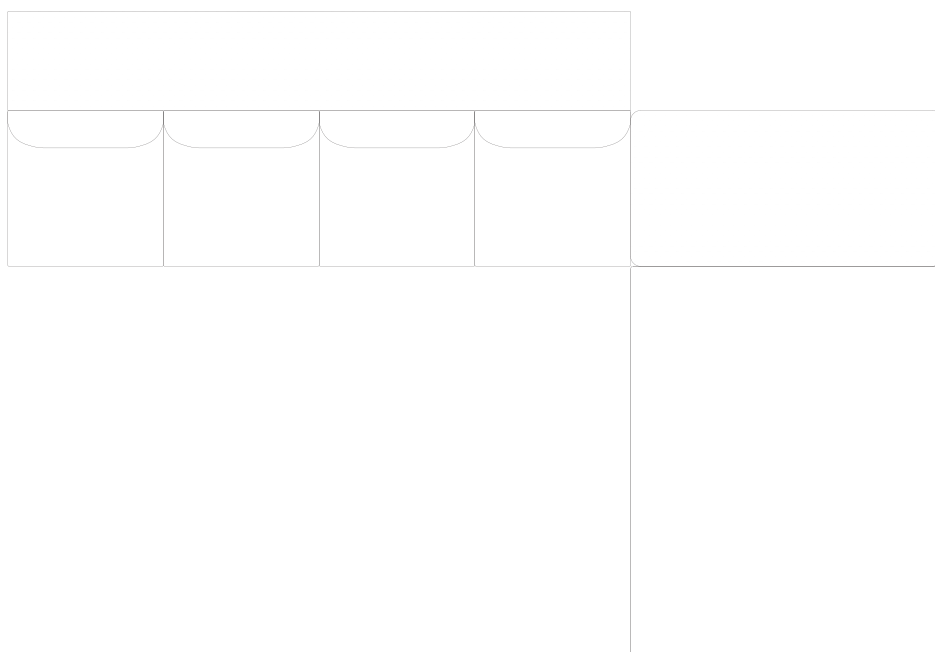

- 
- 1 x Art. 6300 – Structure S252
  - 1 x Art. 6302 – Structure S126
  - 4 x Art. 6304 – Cushion with backrest
  - 1 x Art. 6310 – Rectangular table 126x63 cm
  - 1 x Art. 6307 – Console h 105 cm
  - 1 x Art. 6313 – Ottoman
  - 1 x Art. 6316 – Plate-shaped link

# Kiik

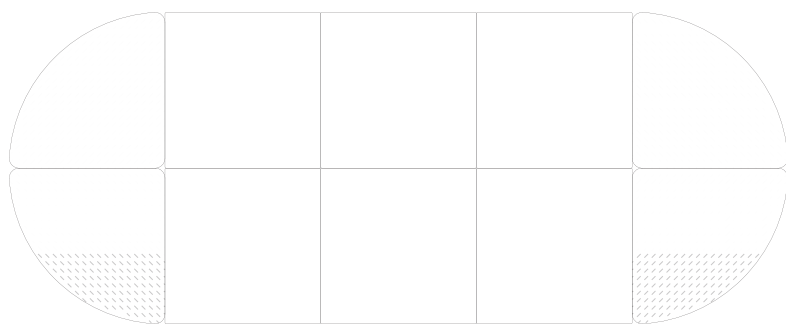

- 
- 2 x Art. 6300 – Structure S252
  - 6 x Art. 6303 – Cushion
  - 4 x Art. 6311 – 1/4 circle table 63x63 cm
  - 2 x Art. 6315 – Island-shaped link
  - 2 x Art. 6316 – Plate-shaped link

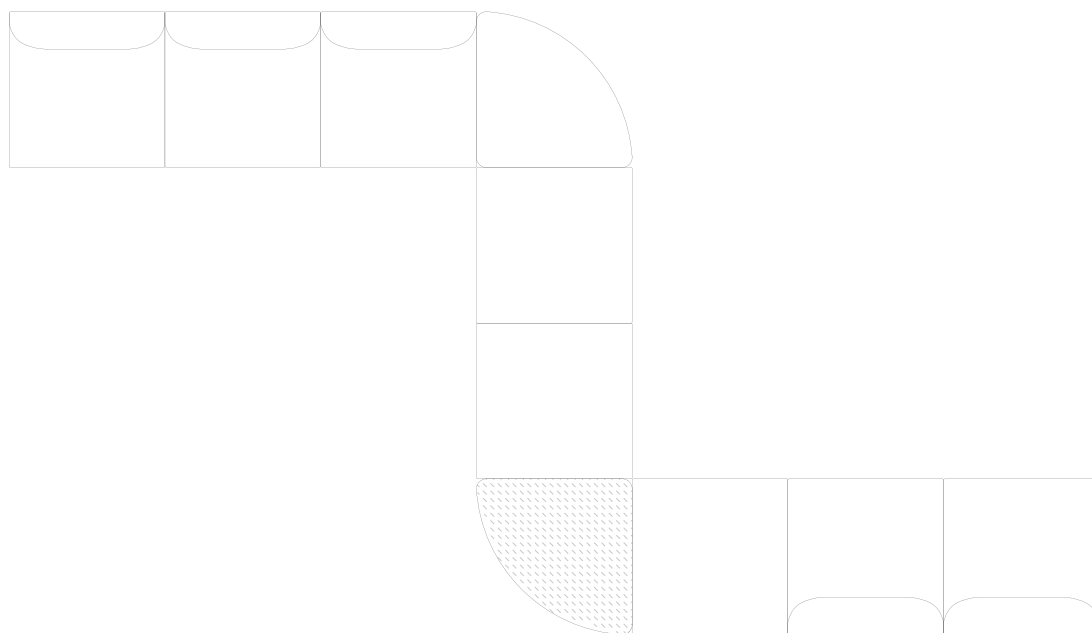

- 
- 2 x Art. 6301 – Structure S189
  - 1 x Art. 6302 – Structure S126
  - 3 x Art. 6303 – Cushion
  - 5 x Art. 6304 – Cushion with backrest
  - 2 x Art. 6311 – 1/4 circle table 63x63 cm
  - 4 x Art. 6314 – C-shaped link



# Kiik

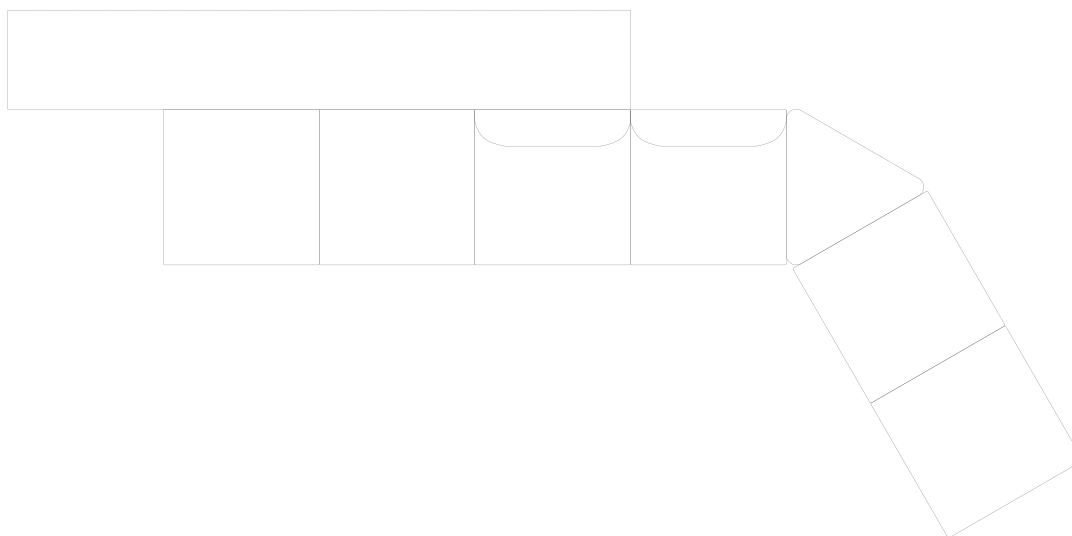

- 
- 1 x Art. 6300 – Structure S252
  - 1 x Art. 6302 – Structure S126
  - 4 x Art. 6303 – Cushion
  - 2 x Art. 6304 – Cushion with backrest
  - 1 x Art. 6312 – Triangular table 63x63x63 cm
  - 3 x Art. 6316 – Plate-shaped link
  - 1 x Art. 6305 – Console h 58 cm

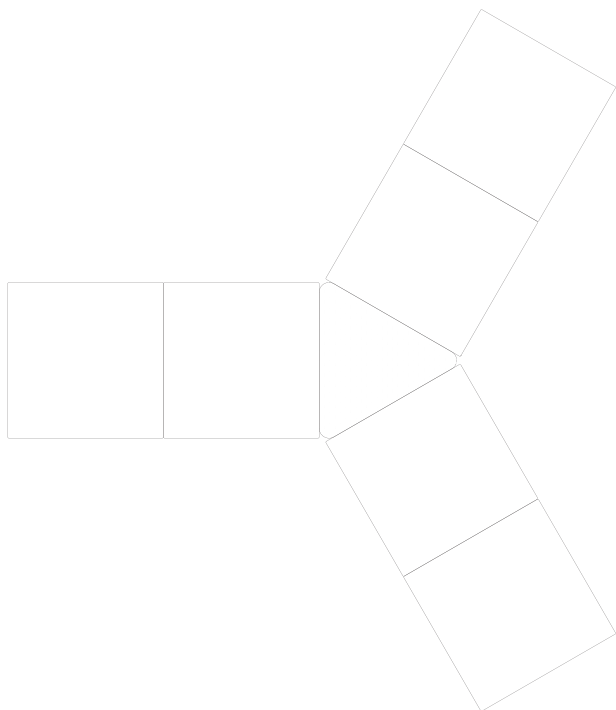

- 
- 3 x Art. 6302 – Structure S126
  - 6 x Art. 6303 – Cushion
  - 1 x Art. 6312 – Triangular table 63x63x63 cm
  - 3 x Art. 6316 – Plate-shaped link

Kiik

**MODULE SEWING SCHEME**

ART.	Non removable cover	Removable cover / coated fabric	soft leather
6303			
6304			
6328			
6329			
6332			
6330			

**MODULE SEWING SCHEME**

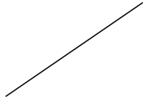
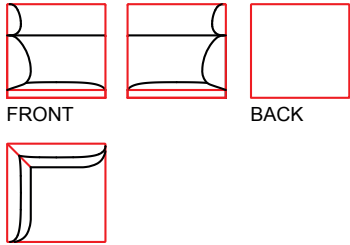
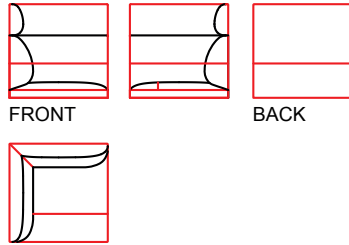
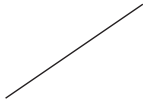
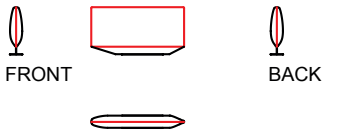
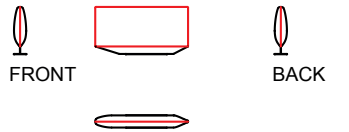
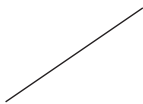
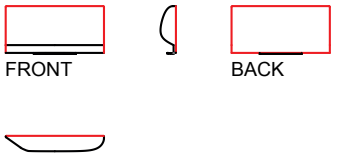
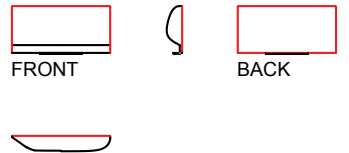
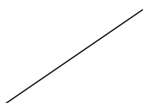
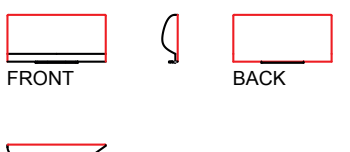
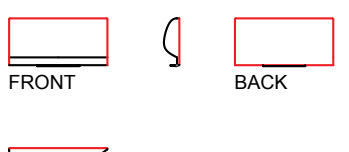
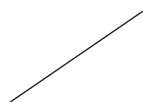
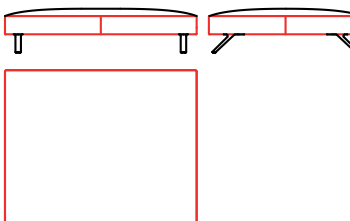
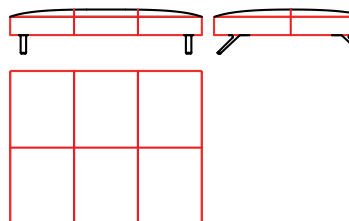
ART.	Non removable cover	Removable cover / coated fabric	soft leather
6331		 <p>FRONT FRONT BACK</p>	 <p>FRONT FRONT BACK</p>
6333		 <p>FRONT FRONT BACK</p>	 <p>FRONT FRONT BACK</p>
6334		 <p>FRONT FRONT BACK</p>	 <p>FRONT FRONT BACK</p>
6335		 <p>FRONT FRONT BACK</p>	 <p>FRONT FRONT BACK</p>
6313			

# Kiik

Design by Ichiro Iwasaki, 2018

Frame composed by a black powder coated metal frame and a set of legs made of pressure diecast aluminum, available in black powder coated. Structure is available in three dimensions to accommodate respectively two, three or four units that can be organized with pads or side tables.

Accessories:  
 C-shaped link Art. 6314  
 Island-shaped link Art. 6315  
 Legs floor fixing system Art. 6320

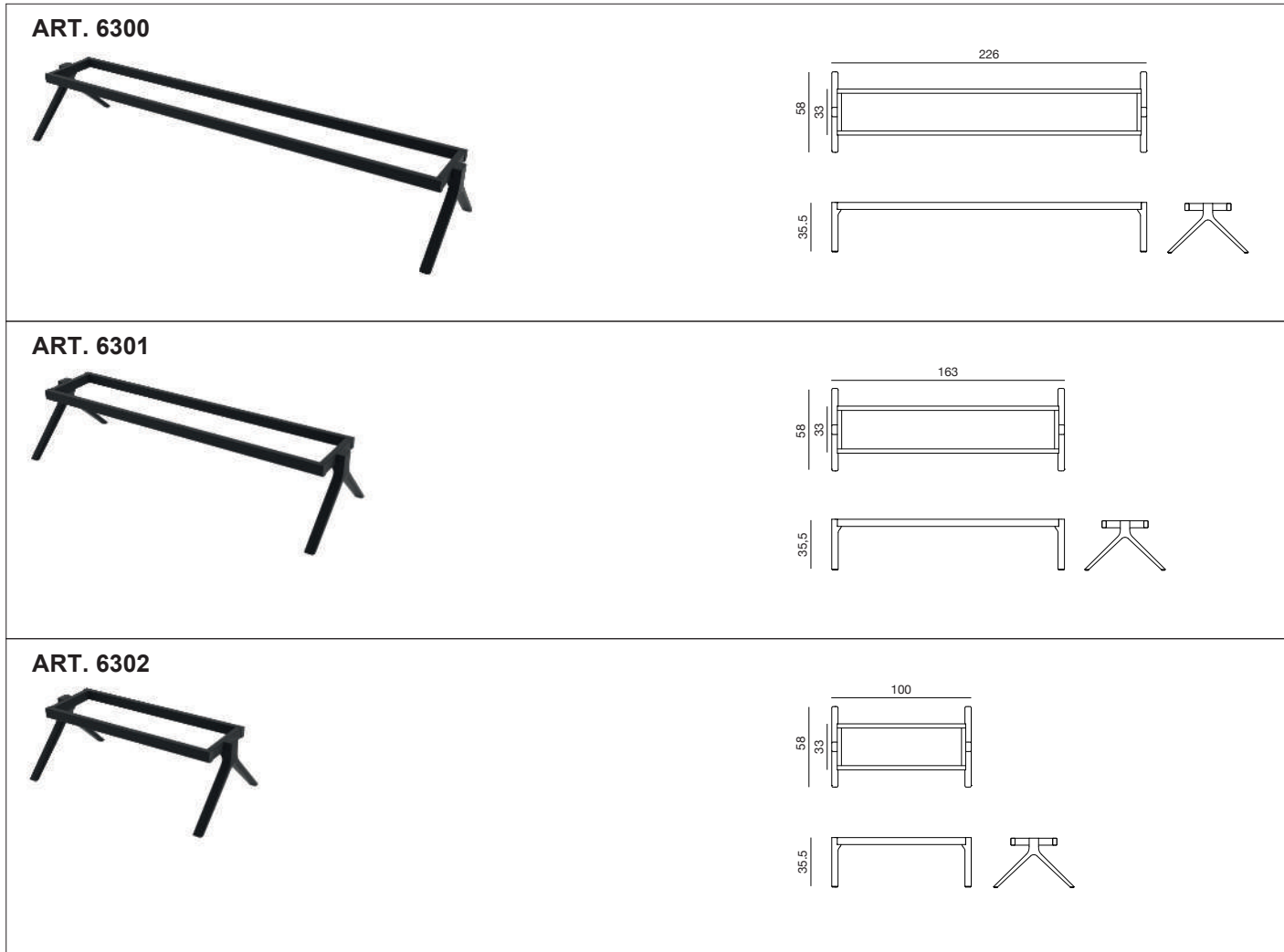

SHIPMENT DETAILS	TECHNICAL SPECIFICATIONS	RESISTANCE TEST
<b>Art. 6300</b> 1 pz = 2  - kg 21/ m³ 0,104 <b>Art. 6301</b> 1 pz = 2  - kg 17/ m³ 0,086 <b>Art. 6302</b> 1 pz = 2  - kg 14/ m³ 0,069		<ul style="list-style-type: none"> <li>• EN 1728:2012 - EN 16139:2013 6.15</li> <li>• EN 1728:2012 - EN 16139:2013 6.18</li> <li>• EN 1728:2012 - EN 16139:2013 6.5</li> <li>• EN 1728:2012 - EN 16139:2013 6.27.1</li> <li>• EN 1728:2012 - EN 16139:2013 6.16</li> <li>• EN 1728:2012 - EN 16139:2013 6.4</li> <li>• EN 1728:2012 - EN 16139:2013 6. 6</li> <li>• EN 1022:2018</li> </ul>



# Kiik

Design by Ichiro Iwasaki, 2018

<b>SEK ART. 6300</b>	-	
Frame - S252	9300	
<b>SEK ART. 6301</b>	-	
Frame - S189	8132	
<b>SEK ART. 6302</b>	-	
Frame - S126	7383	

**FIRE RETARDANT TEST**

Frame Base



V39  
matt

Legs



V39  
matt



# Kiik

Design by Ichiro Iwasaki, 2018

One-seat module to be fixed to the structures. available in two versions: only cushion or cushion with backrest. both versions can be upholstered with fabric, leather, coated fabric, or customer's fabric or leather removable cover.

Accessories:  
 USB Art. 6001  
 Replacement cover set Art. 6317  
 Separator between seats Art. 6336

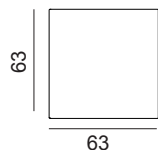

SEK ART. 6303	A	B COM	C COL	D	E	F	G	H	I	J	K	L	M	ES
Cushion 63 x 63 x 10 cm	4393	4667	4941	5215	5489	5763	6037	6311	6585	6859	7133	7407	7681	8787
<b>SHIPMENT DETAILS</b>		<b>TECHNICAL SPECIFICATIONS</b>				<b>RESISTANCE TEST</b>								
<b>Art.6303</b> 1 pz = 1  - kg 5,5/ m³ 0,069		<b>Art.6303</b> COL requirement m² 1.92 H 140 cm. COM Meterage m 1.18				<ul style="list-style-type: none"> <li>• EN 1728:2012 - EN 16139:2013 6.15</li> <li>• EN 1728:2012 - EN 16139:2013 6.4</li> <li>• EN 1728:2012 - EN 16139:2013 6.6</li> </ul>			<ul style="list-style-type: none"> <li>• EN 1728:2012 - EN 16139:2013 6.16</li> <li>• EN 1728:2012 - EN 16139:2013 6.5</li> <li>• EN 1728:2012 - EN 16139:2013 6.27.1</li> </ul>					
<b>FIRE RETARDANT TEST</b>														
Classe 1IM Omologazione Italia Remix 3 Kvadrat. Tonus 4 Kvadrat.														



# Kiik

Design by Ichiro Iwasaki, 2018

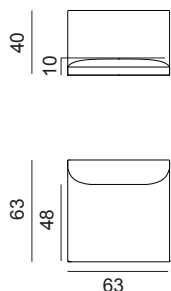

One-seat module to be fixed to the structures. available in two versions: only cushion or cushion with backrest. both versions can be upholstered with fabric, leather, coated fabric, or customer's fabric or leather removable cover.

- Accessories:
- USB Art. 6001
  - Replacement cover set Art. 6318
  - Middle armrest Art. 6333
  - Terminal armrest - Right Art. 6334
  - Terminal armrest - Left Art. 6335
  - Separator between seats Art. 6336

SEK ART. 6304	A	B COM	C COL	D	E	F	G	H	I	J	K	L	M	ES
Backrest cushion 63 x 63 x 40 cm	7120	7549	7978	8407	8836	9265	9694	10123	10552	10981	11410	11839	12268	13955
<b>SHIPMENT DETAILS</b>		<b>TECHNICAL SPECIFICATIONS</b>				<b>RESISTANCE TEST</b>								
<b>Art.6304</b> 1 pz = 1  - kg 9/ m³ 0,224		<b>Art.6304</b> COL requirement m² 3.24 H 140 cm. COM Meterage m 2.04				<ul style="list-style-type: none"> <li>• EN 1728:2012 - EN 16139:2013 6.15</li> <li>• EN 1728:2012 - EN 16139:2013 6.4</li> <li>• EN 1728:2012 - EN 16139:2013 6.6</li> </ul>			<ul style="list-style-type: none"> <li>• EN 1728:2012 - EN 16139:2013 6.16</li> <li>• EN 1728:2012 - EN 16139:2013 6.5</li> <li>• EN 1728:2012 - EN 16139:2013 6.27.1</li> </ul>					
<b>FIRE RETARDANT TEST</b>														
Classe 1IM Omologazione Italia Remix 3 Kvadrat. Tonus 4 Kvadrat.														





# Kiik

Design by Ichiro Iwasaki, 2019



One-seat module in angular cushion with standard backrest version to be fixed to the structures for 90° configurations. It can be upholstered with fabric, leather, coated fabric, or customer's fabric or leather removable cover. Available in right (Item 6328) and left (Item 6329) versions.

Accessories:  
 USB Art. 6001  
 Plate-shaped link Art. 6316  
 Replacement cover set Art. 6337  
 Replacement cover set Art. 6338

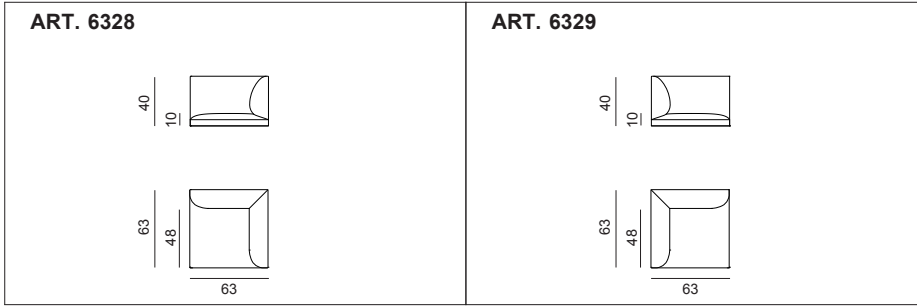

<b>SEK ART. 6328</b>	A	B COM	C COL	D	E	F	G	H	I	J	K	L	M	ES
Cushion with right angular standard backrest	10573	11085	11597	12109	12621	13133	13645	14157	14669	15181	15693	16205	16717	18717
<b>SEK ART. 6329</b>	A	B COM	C COL	D	E	F	G	H	I	J	K	L	M	ES
Cushion with left angular standard backrest	10573	11085	11597	12109	12621	13133	13645	14157	14669	15181	15693	16205	16717	18717

SHIPMENT DETAILS	TECHNICAL SPECIFICATIONS	RESISTANCE TEST
<b>Art. 6328</b> 1 pz = 1  - kg 17,5/ m³ 0,224 <b>Art. 6329</b> 1 pz = 1  - kg 17,5/ m³ 0,224	<b>Art.6328</b> COL requirement m² 4.56 H 140 cm. COM Meterage m 1.78 <b>Art.6329</b> COL requirement m² 4.56 H 140 cm. COM Meterage m 1.78	
FIRE RETARDANT TEST		
Classe 1IM Omologazione Italia Remix 3 Kvadrat. Tonus 4 Kvadrat.		



# Kiik

Design by Ichiro Iwasaki, 2019

One-seat module with high backrest version to be fixed to the structures . It can be upholstered with fabric, leather, coated fabric, or customer's fabric or leather removable cover.

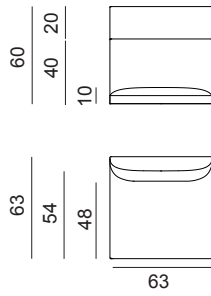

Accessories:  
 USB Art. 6001  
 Plate-shaped link Art. 6316  
 Middle armrest Art. 6333  
 Terminal armrest - Right Art. 6334  
 Terminal armrest - Left Art. 6335  
 Separator between seats Art. 6336  
 Replacement cover set Art. 6341

SEK ART. 6332	A	B COM	C COL	D	E	F	G	H	I	J	K	L	M	ES
Cushion with high backrest	9168	9668	10168	10668	11168	11668	12168	12668	13168	13668	14168	14668	15168	17099
<b>SHIPMENT DETAILS</b>	<b>TECHNICAL SPECIFICATIONS</b>				<b>RESISTANCE TEST</b>									
<b>Art.6332</b> 1 pz = 1  - kg 14,5/ m³ 0,333	<b>Art.6332</b> COL requirement m² 4.42 H 140 cm. COM Meterage m 2.43				• EN 1728:2012 - EN 16139:2013 6.4					• EN 1728:2012 - EN 16139:2013 6. 6				
<b>FIRE RETARDANT TEST</b>														
Classe 1IM Omologazione Italia Remix 3 Kvadrat. Tonus 4 Kvadrat.														



# Kiik

Design by Ichiro Iwasaki, 2019



One-seat module in angular cushion with high backrest version to be fixed to the structures for 90° configurations. It can be upholstered with fabric, leather, coated fabric, or customer's fabric or leather removable cover. Available in right (Item 6330) and left (Item 6331) versions.

Accessories:  
 USB Art. 6001  
 Plate-shaped link Art. 6316  
 Replacement cover set Art. 6339  
 Replacement cover set Art. 6340

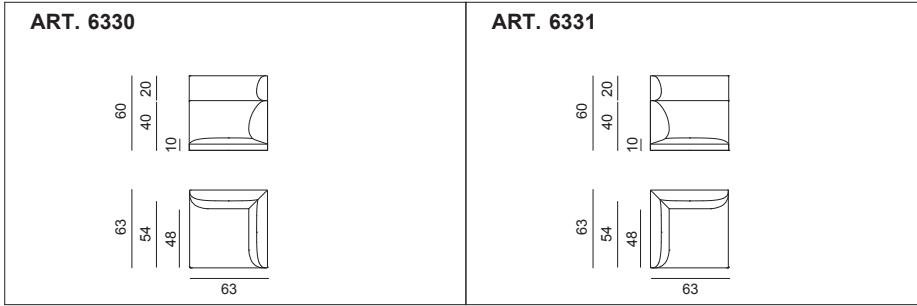

<b>SEK ART. 6330</b>	A	B COM	C COL	D	E	F	G	H	I	J	K	L	M	ES
Cushion with right angular high backrest	13229	13860	14491	15122	15753	16384	17015	17646	18277	18908	19539	20170	20801	23350
<b>SEK ART. 6331</b>	A	B COM	C COL	D	E	F	G	H	I	J	K	L	M	ES
Cushion with left angular high backrest	13229	13860	14491	15122	15753	16384	17015	17646	18277	18908	19539	20170	20801	23350

SHIPMENT DETAILS	TECHNICAL SPECIFICATIONS	RESISTANCE TEST
<b>Art. 6330</b> 1 pz = 1  - kg 20/ m³ 0,333 <b>Art. 6331</b> 1 pz = 1  - kg 20/ m³ 0,333	<b>Art.6330</b> COL requirement m² 6.24 H 140 cm. COM Meterage m 2.53 <b>Art.6331</b> COL requirement m² 6.24 H 140 cm. COM Meterage m 2.53	
<b>FIRE RETARDANT TEST</b> Classe 1IM Omologazione Italia Remix 3 Kvadrat. Tonus 4 Kvadrat.		



# Kiik

Design by Ichiro Iwasaki, 2019

Side armrest to be fixed to a one-seat module with backrest version, standard or high, at the ends of a configuration. It can be upholstered with fabric, leather, coated fabric, or customer's fabric or leather removable cover. Available in right (Item 6334) and left (Item 6335) versions.



**Accessories:**

Separator between seats Art. 6336

Replacement cover set Art. 6343

Replacement cover set Art. 6344

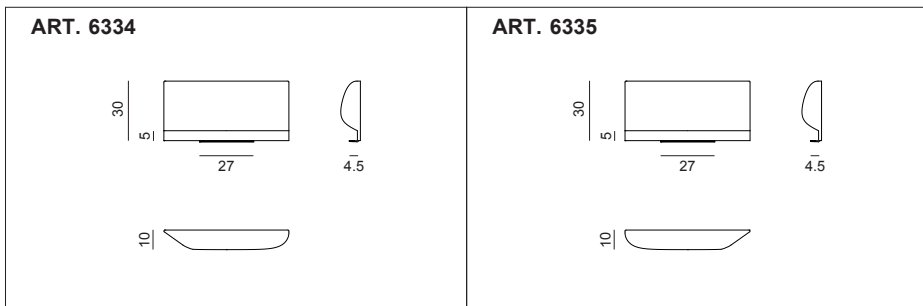

<b>SEK ART. 6334</b>	A	B COM	C COL	D	E	F	G	H	I	J	K	L	M	ES
Terminal armrest - Right	2846	3000	3154	3308	3462	3616	3770	3924	4078	4232	4386	4540	4694	5263
<b>SEK ART. 6335</b>	A	B COM	C COL	D	E	F	G	H	I	J	K	L	M	ES
Terminal armrest - Left	2846	3000	3154	3308	3462	3616	3770	3924	4078	4232	4386	4540	4694	5263

SHIPMENT DETAILS	TECHNICAL SPECIFICATIONS	RESISTANCE TEST
<b>Art. 6334</b> 1 pz = 1  - kg 3,8/ m² 0,03 <b>Art. 6335</b> 1 pz = 1  - kg 3,8/ m² 0,03	<b>Art.6334</b> COL requirement m² 1.44 H 140 cm. COM Meterage m 0.83 <b>Art.6335</b> COL requirement m² 1.44 H 140 cm. COM Meterage m 0.83	<ul style="list-style-type: none"> <li>• EN 1728:2012 - EN 16139:2013 6.10</li> <li>• EN 1728:2012 - EN 16139:2013 6.20</li> <li>• EN 1728:2012 - EN 16139:2013 6.11</li> <li>• EN 1728:2012 - EN 16139:2013 6.26</li> </ul>
<b>FIRE RETARDANT TEST</b>		



# Kiik

Design by Ichiro Iwasaki, 2019

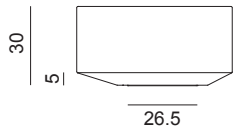

Middle armrest to be fixed between two one-seat module with backrest version, standard or high, facing in the same direction. It can be upholstered with fabric, leather, coated fabric, or customer's fabric or leather removable cover.

Accessories:  
 Separator between seats Art. 6336  
 Replacement cover set Art. 6342



SEK ART. 6333	A	B COM	C COL	D	E	F	G	H	I	J	K	L	M	ES
Middle armrest	3322	3476	3630	3784	3938	4092	4246	4400	4554	4708	4862	5016	5170	5751
<b>SHIPMENT DETAILS</b>	<b>TECHNICAL SPECIFICATIONS</b>				<b>RESISTANCE TEST</b>									
<b>Art.6333</b> 1 pz = 1  - kg 4/ m³ 0,03	<b>Art.6333</b> COL requirement m² 1.32 H 140 cm. COM Meterage m 0.58				<ul style="list-style-type: none"> <li>EN 1728:2012 - EN 16139:2013 6.10</li> <li>EN 1728:2012 - EN 16139:2013 6.20</li> </ul>					<ul style="list-style-type: none"> <li>EN 1728:2012 - EN 16139:2013 6.11</li> <li>EN 1728:2012 - EN 16139:2013 6.26</li> </ul>				
<b>FIRE RETARDANT TEST</b>														



# Kiik

Design by Ichiro Iwasaki, 2019

Separator between seats in painted MDF to be fixed between two one-seat modules with or without backrest.

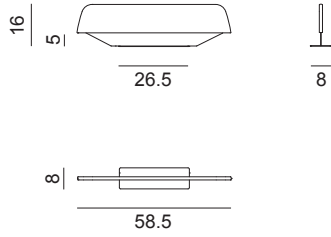

<b>SEK ART. 6336</b>	MDF	
Seat divider	1441	
<b>SHIPMENT DETAILS</b>	<b>TECHNICAL SPECIFICATIONS</b>	<b>RESISTANCE TEST</b>
Art.6336 1 pz = 1  - kg 2,4/ m² 0,012		
<b>FIRE RETARDANT TEST</b>		











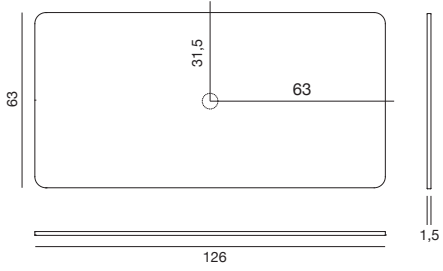

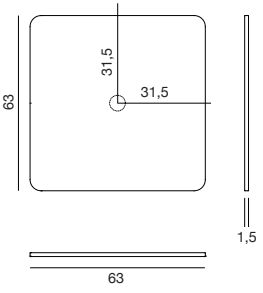
# Kiik

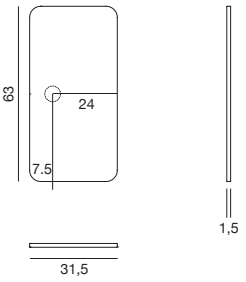
Design by Ichiro Iwasaki, 2018

Side table available in 5 shapes and sizes. Square and rectangular shape side tables can be positioned on the frames as a replacement to cushions modules. The 31.5x63 cm rectangular side table can be positioned overhanging with respect to the frames using a special support link. The triangular and quarter round side tables work as connections for two or more arrangements, allowing for L-shaped and linear modules (120° and 90°). All side tables are available in laminate with black oak or natural oak effect; they can be powered with the Bachmann Pix accessory - USB version.

Accessories:  
 USB Art. 6001  
 C-shaped link Art. 6314  
 Island-shaped link Art. 6315  
 Plate-shaped link Art. 6316

<p><b>ART. 6308</b></p> 	
<p><b>ART. 6309</b></p> 	
<p><b>ART. 6310</b></p> 	

SHIPMENT DETAILS	TECHNICAL SPECIFICATIONS	RESISTANCE TEST
<p><b>Art. 6308</b>            1 pz = 1  - kg 12/ m³ 0,033            1 pz = 2  - kg 12/ m³ 0,033</p> <p><b>Art. 6309</b>            1 pz = 1  - kg 5/ m³ 0,017            1 pz = 2  - kg 5/ m³ 0,017</p> <p><b>Art. 6310</b>            1 pz = 1  - kg 3/ m³ 0,009            1 pz = 2  - kg 3/ m³ 0,009</p>		



<b>SEK ART. 6308</b>	<b>LM</b>	
Rectangular table 126 x 63 cm	2715	
Grommet + electrification	+ 1643	
<b>SEK ART. 6309</b>	<b>LM</b>	
Square table 63 x 63 cm	1679	
Grommet + electrification	+ 1643	
<b>SEK ART. 6310</b>	<b>LM</b>	
Rectangular table 31,5 x 63 cm	1155	
Grommet + electrification	+ 1643	
<b>FIRE RETARDANT TEST</b>		

Top

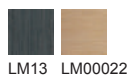

LM13 LM00022



Single cable unit (1 USB + 1 connector)





# Kiik

Design by Ichiro Iwasaki, 2018

Side table available in 5 shapes and sizes. Square and rectangular shape side tables can be positioned on the frames as a replacement to cushions modules. The 31.5x63 cm rectangular side table can be positioned overhanging with respect to the frames using a special support link. The triangular and quarter round side tables work as connections for two or more arrangements, allowing for L-shaped and linear modules (120° and 90°). All side tables are available in laminate with black oak or natural oak effect; they can be powered with the Bachmann Pix accessory - USB version.

Accessories:  
 USB Art. 6001  
 C-shaped link Art. 6314  
 Island-shaped link Art. 6315  
 Plate-shaped link Art. 6316

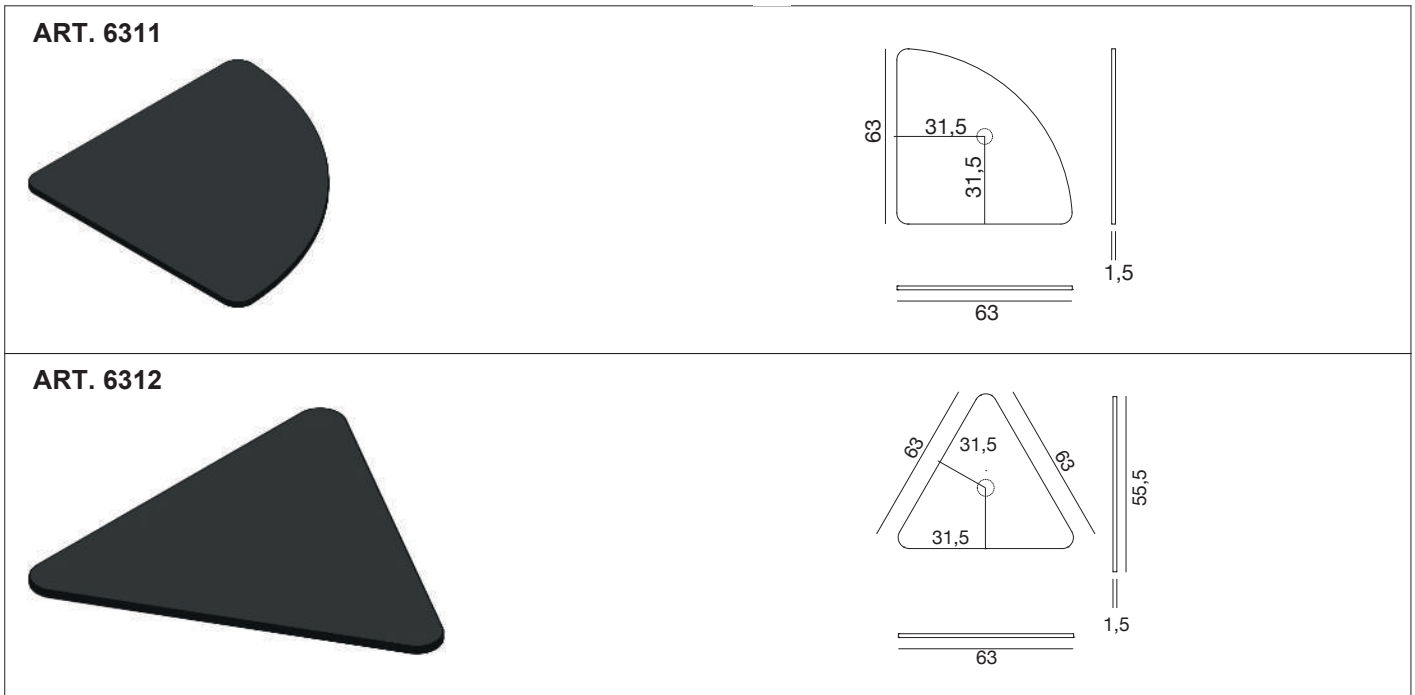

SHIPMENT DETAILS	TECHNICAL SPECIFICATIONS	RESISTANCE TEST
<b>Art. 6311</b> 1 pz = 1  - kg 5/ m³ 0,017 1 pz = 2  - kg 5/ m³ 0,017 <b>Art. 6312</b> 1 pz = 1  - kg 4/ m³ 0,017 1 pz = 2  - kg 4/ m³ 0,017		



# Kiik

Design by Ichiro Iwasaki, 2018

<b>SEK ART. 6311</b>	<b>LM</b>	
1/4 circle table 63 x 63 cm - 90°	1953	
Grommet + electrification	+ 1643	
<b>SEK ART. 6312</b>	<b>LM</b>	
Triangular table 63 x 63 x 63 cm - 60°	1715	
Grommet + electrification	+ 1643	

## FIRE RETARDANT TEST

Top

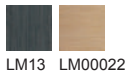

LM13 LM00022



Single cable unit (1 USB + 1 connector)



# Kiik Console

Design by Ichiro Iwasaki, 2018

Console available in three heights: 58.5, 72.5 and 105.5 cm in laminate with black oak or natural oak effect. The console can be powered with two Bachmann Pix accessories - USB version.

Accessories:

Floor fixing kit for consoles Art. 6321

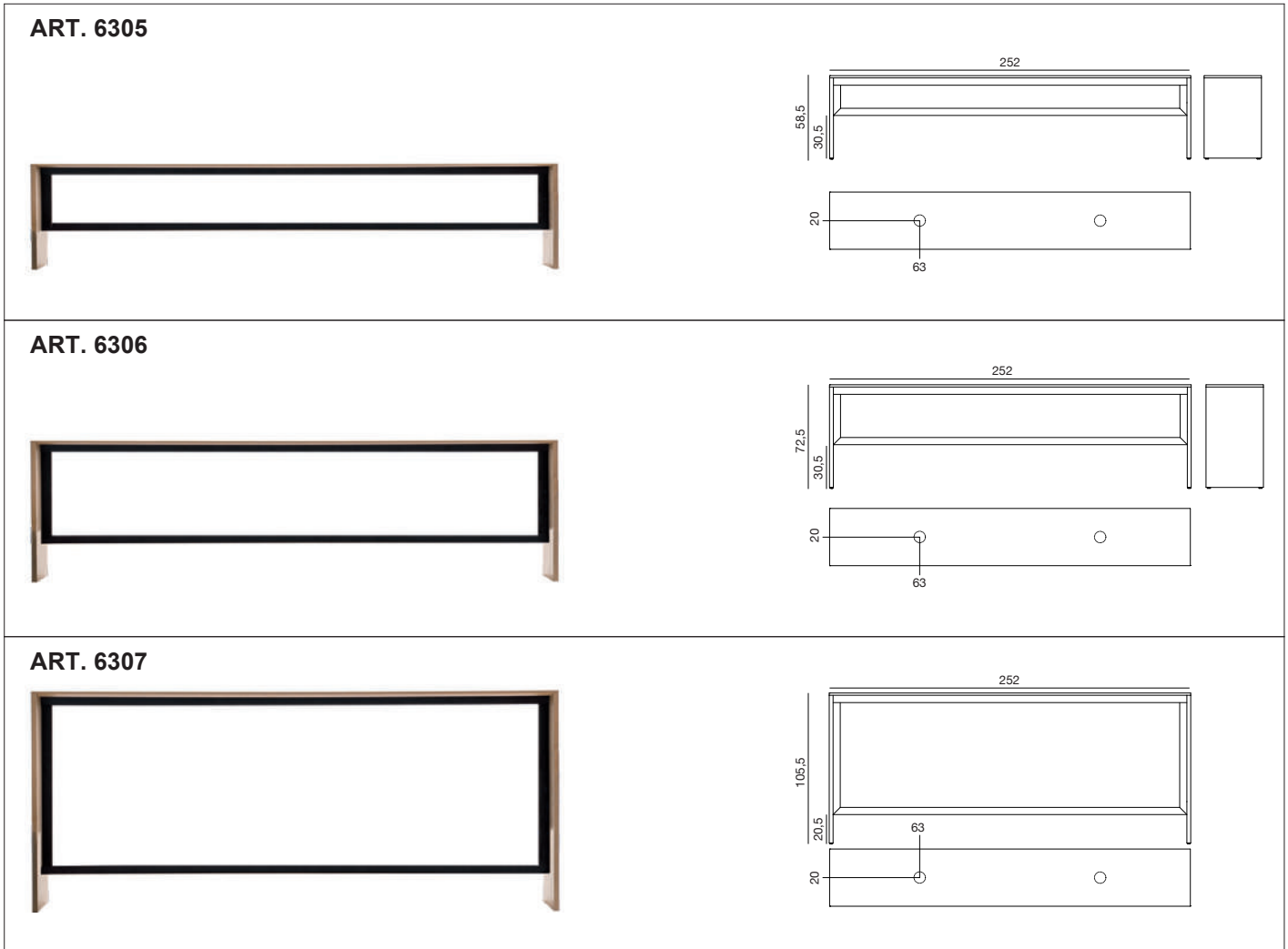

SHIPMENT DETAILS	TECHNICAL SPECIFICATIONS	RESISTANCE TEST
<p><b>Art. 6305</b></p> <p>1 pz = 3  - kg 42/ m³ 0,205</p> <p>1 pz = 5  - kg 44/ m³ 0,213</p> <p><b>Art. 6306</b></p> <p>1 pz = 3  - kg 45/ m³ 0,209</p> <p>1 pz = 5  - kg 47/ m³ 0,216</p> <p><b>Art. 6307</b></p> <p>1 pz = 3  - kg 49/ m³ 0,217</p> <p>1 pz = 5  - kg 51/ m³ 0,224</p>		<ul style="list-style-type: none"> <li>• EN 1728:2012 - EN 16139:2013 6.17</li> <li>• EN 1728:2012 - EN 16139:2013 6.24</li> <li>• EN 1728:2012 - EN 16139:2013 6.5</li> <li>• EN 1730:2012 - EN 15372:2016 6.2</li> <li>• EN 1730:2012 - EN 15372:2016 6.4.2</li> <li>• EN 1730:2012 - EN 15372:2016 6.7</li> <li>• EN 1730:2012 - EN 15372:2016 6.4.3</li> </ul> <ul style="list-style-type: none"> <li>• EN 1728:2012 - EN 16139:2013 6.18</li> <li>• EN 1728:2012 - EN 16139:2013 6.25</li> <li>• EN 1730:2012 - EN 15372:2016 5.1-5.2</li> <li>• EN 1730:2012 - EN 15372:2016 6.3</li> <li>• EN 1730:2012 - EN 15372:2016 6.6</li> <li>• EN 1730:2012 - EN 15372:2016 6.9</li> <li>• EN 1730:2012 - EN 15372:2016 7.2</li> </ul>



# Kiik Console

Design by Ichiro Iwasaki, 2018

<b>SEK ART. 6305</b>	<b>LM</b>	
Console h 58.5 - 252x40x58.5 cm	15683	
Dual grommets + electrification	+ 3132	
<b>SEK ART. 6306</b>	<b>LM</b>	
Console h 72.5 - 252x40x72.5 cm	17468	
Dual grommets + electrification	+ 3132	
<b>SEK ART. 6307</b>	<b>LM</b>	
Console h 105.5 - 252 x 40 x 105.5 cm	19196	
Dual grommets + electrification	+ 3132	
<b>FIRE RETARDANT TEST</b>		

Frame Base



V39  
matt

Top + side



LM13 LM00022



Single cable unit (1 USB + 1 connector)



# Kiik

Design by Ichiro Iwasaki, 2018



Ottoman composed by a set of four legs made of black coated pressure die-cast aluminum, with a wide upholstered seat available in fabric, leather, coated fabric, or customer's fabric or leather removable cover.

Accessories:  
 USB Art. 6001  
 Replacement cover set Art. 6319  
 Legs floor fixing system Art. 6320

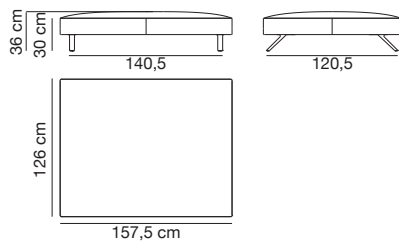

SEK ART. 6313	A	B GOM	C COL	D	E	F	G	H	I	J	K	L	M	ES
		27005	28076	29147	30218	31289	32360	33431	34502	35573	36644	37715	38786	39857

SHIPMENT DETAILS	TECHNICAL SPECIFICATIONS	RESISTANCE TEST
<b>Art. 6313</b> 1 pz = 1  - kg 50/ m² 0,508	<b>Art.6313</b> COL requirement m² 9.45 H 140 cm. COM Meterage m 3.44	<ul style="list-style-type: none"> <li>• EN 1728:2012 - EN 16139:2013 6.15</li> <li>• EN 1728:2012 - EN 16139:2013 6.17</li> <li>• EN 1728:2012 - EN 16139:2013 6.24</li> <li>• EN 1728:2012 - EN 16139:2013 6.4</li> <li>• EN 1728:2012 - EN 16139:2013 6.27.1</li> </ul> <ul style="list-style-type: none"> <li>• EN 1728:2012 - EN 16139:2013 6.16</li> <li>• EN 1728:2012 - EN 16139:2013 6.18</li> <li>• EN 1728:2012 - EN 16139:2013 6.25</li> <li>• EN 1728:2012 - EN 16139:2013 6.5</li> </ul>
<b>FIRE RETARDANT TEST</b> Classe 1IM Omologazione Italia Remix 3 Kvadrat. Tonus 4 Kvadrat.		





Frame Base

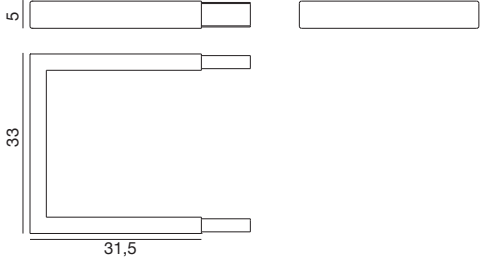
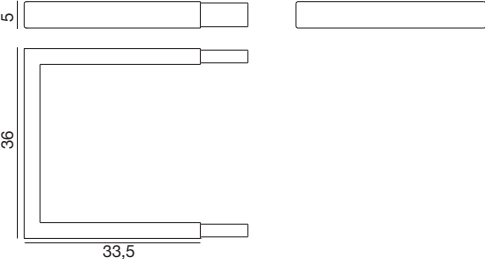
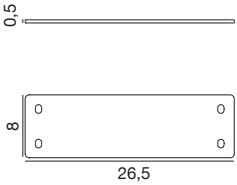

## Accessories

Design by Ichiro Iwasaki, 2018

Useful links to create arrangements and anchor some elements. The Plate-shaped link (Art.6316) can be used to connect two sofas or to anchor a triangular side table between two or three sofas in a linear (120°) arrangement. The C-shaped link (Art. 6314) can be used to anchor a 31.5x63 cm rectangular side table overhanging from a frame or to support a quarter round side table between two sofas in a L-shaped (90°) arrangement. The Island-shaped link (Art. 6315) can be used for special arrangements that require putting two frames one next to the other (S189 or S252) and a final arrangement with four or six pads and four quarter round side tables.







<p><b>ART. 6314</b></p>  <p><b>C-shaped link - 31 x 33 x 5</b></p> <p><b>SEK 1215</b></p>	<p><b>ART. 6315</b></p>  <p><b>Island-shaped link - 33,4 x 36 x 5</b></p> <p><b>SEK 1346</b></p>	
<p><b>ART. 6316</b></p>  <p><b>Plate-shaped link - 26,6 x 8</b></p> <p><b>SEK 488</b></p>		
<p><b>SHIPMENT DETAILS</b></p> <p><b>Art. 6314</b> 1 pz = 1  - kg 3,5/ m³ 0,001</p> <p><b>Art. 6315</b> 1 pz = 1  - kg 3,5/ m³ 0,001</p> <p><b>Art. 6316</b> 1 pz = 1  - kg 1,5/ m³ 0,001</p>	<p><b>TECHNICAL SPECIFICATIONS</b></p>	<p><b>RESISTANCE TEST</b></p>



# Accessories

Design by Ichiro Iwasaki, 2018

<b>SEK ART. 6317</b>	A	B COM	C COL	D	E	F	G	H	I	J	K	L	M	ES
SPARE COVER ART. 6303 - Cushion 63 x 63 x 10 cm	1358	1632	1906	2180	2454	2728	3002	3276	3550	3824	4098	4372	4646	5763
<b>SEK ART. 6318</b>	A	B COM	C COL	D	E	F	G	H	I	J	K	L	M	ES
SPARE COVER ART. 6304 - Backrest cushion 63 x 63 x 40 cm	2168	2597	3026	3455	3884	4313	4742	5171	5600	6029	6458	6887	7316	8990
<b>SEK ART. 6337</b>	A	B COM	C COL	D	E	F	G	H	I	J	K	L	M	ES
SPARE COVER ART. 6328 - Cushion with right angular standard backrest	2595	3107	3619	4131	4643	5155	5667	6179	6691	7203	7715	8227	8739	10741
<b>SEK ART. 6338</b>	A	B COM	C COL	D	E	F	G	H	I	J	K	L	M	ES
SPARE COVER ART. 6329 - Cushion with left angular standard backrest	2595	3107	3619	4131	4643	5155	5667	6179	6691	7203	7715	8227	8739	10741
<b>SEK ART. 6339</b>	A	B COM	C COL	D	E	F	G	H	I	J	K	L	M	ES
SPARE COVER ART. 6330 - Cushion with right angular high backrest	3263	3894	4525	5156	5787	6418	7049	7680	8311	8942	9573	10204	10835	13383
<b>SEK ART. 6341</b>	A	B COM	C COL	D	E	F	G	H	I	J	K	L	M	ES
SPARE COVER ART. 6332 - Cushion with high backrest	2370	2870	3370	3870	4370	4870	5370	5870	6370	6870	7370	7870	8370	10288





SHIPMENT DETAILS	TECHNICAL SPECIFICATIONS	RESISTANCE TEST
<b>Art. 6317</b> 1 pz = 1  - kg 5/ m³ 0,036 <b>Art. 6318</b> 1 pz = 1  - kg 5/ m³ 0,036 <b>Art. 6337</b> 1 pz = 1  - kg 5/ m³ 0,042 <b>Art. 6338</b> 1 pz = 1  - kg 5/ m³ 0,042 <b>Art. 6339</b> 1 pz = 1  - kg 5/ m³ 0,042 <b>Art. 6341</b> 1 pz = 1  - kg 5/ m³ 0,042	<b>Art.6317</b> COL requirement m² 1.92 H 140 cm. COM Meterage m 1.18 <b>Art.6318</b> COL requirement m² 3.24 H 140 cm. COM Meterage m 2.04 <b>Art.6337</b> COL requirement m² 4.56 H 140 cm. COM Meterage m 1.78 <b>Art.6338</b> COL requirement m² 4.56 H 140 cm. COM Meterage m 1.78 <b>Art.6339</b> COL requirement m² 6.24 H 140 cm. COM Meterage m 2.53 <b>Art.6341</b> COL requirement m² 4.42 H 140 cm. COM Meterage m 2.43	
<b>FIRE RETARDANT TEST</b>		



# Accessories

Design by Ichiro Iwasaki, 2018



<b>SEK ART. 6319</b>	A	B COM	C COL	D	E	F	G	H	I	J	K	L	M	ES
SPARE COVER	3632	4703	5774	6845	7916	8987	10058	11129	12200	13271	14342	15413	16484	20802
<b>SEK ART. 6340</b>	A	B COM	C COL	D	E	F	G	H	I	J	K	L	M	ES
SPARE COVER ART. 6331- Cushion with left angular high backrest	3263	3894	4525	5156	5787	6418	7049	7680	8311	8942	9573	10204	10835	13383
<b>SEK ART. 6342</b>	A	B COM	C COL	D	E	F	G	H	I	J	K	L	M	ES
SPARE COVER ART. 6333 - Middle armrest	1191	1345	1499	1653	1807	1961	2115	2269	2423	2577	2731	2885	3039	3620
<b>SEK ART. 6343</b>	A	B COM	C COL	D	E	F	G	H	I	J	K	L	M	ES
SPARE COVER ART. 6334 - Terminal armrest - Right	1191	1345	1499	1653	1807	1961	2115	2269	2423	2577	2731	2885	3039	3620
<b>SEK ART. 6344</b>	A	B COM	C COL	D	E	F	G	H	I	J	K	L	M	ES
SPARE COVER ART. 6335 - Lateral armrest - Left	1191	1345	1499	1653	1807	1961	2115	2269	2423	2577	2731	2885	3039	3620



SHIPMENT DETAILS	TECHNICAL SPECIFICATIONS	RESISTANCE TEST
<b>Art. 6319</b> 1 pz = 1  - kg 8/ m³ 0,036 <b>Art. 6340</b> 1 pz = 1  - kg 5/ m³ 0,042 <b>Art. 6342</b> 1 pz = 1  - kg 3/ m³ 0,042 <b>Art. 6343</b> 1 pz = 1  - kg 3/ m³ 0,042 <b>Art. 6344</b> 1 pz = 1  - kg 3/ m³ 0,042	<b>Art.6319</b> COL requirement m² 9.45 H 140 cm. COM Meterage m 3.44 <b>Art.6340</b> COL requirement m² 6.24 H 140 cm. COM Meterage m 2.53 <b>Art.6342</b> COL requirement m² 1.32 H 140 cm. COM Meterage m 0.58 <b>Art.6343</b> COL requirement m² 1.44 H 140 cm. COM Meterage m 0.83 <b>Art.6344</b> COL requirement m² 1.44 H 140 cm. COM Meterage m 0.83	
<b>FIRE RETARDANT TEST</b>		



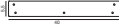

## Accessories

<b>SEK ART. 6001</b>	<b>SEK ART. 6320</b>	<b>SEK ART. 6321</b>
		
<p>Power supply kit consisting of 2 units with 2 USB A sockets each, 1 power supply unit and cable clamps. Electric cable not included.</p>	<p>Legs floor fixing system</p>	<p>Floor fixing kit for consoles</p>
1655	654	1036

<b>SHIPMENT DETAILS</b>	<b>TECHNICAL SPECIFICATIONS</b>	<b>RESISTANCE TEST</b>
<p><b>Art. 6320</b> 1 pz = 1  - kg 1/m<sup>3</sup> 0</p> <p><b>Art. 6321</b> 1 pz = 1  - kg 1/m<sup>3</sup> 0,001</p>		
<p><b>FIRE RETARDANT TEST</b></p>		



# LOOP

---

Design by  
Lievore Altherr Molina  
2009

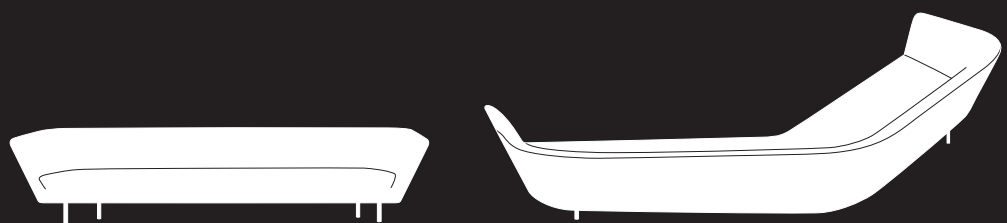

# Loop

## Collection overview

---

### Type

Freestanding



---

Sofa — 2 seats

Sofa — 3 seats

### Modular elements



### Linear

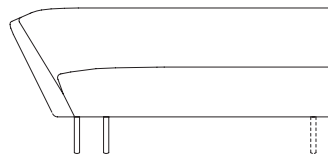
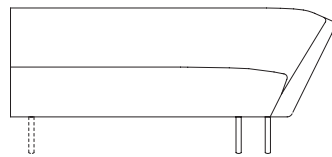
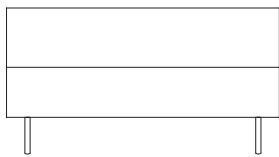

With right armrest

With left armrest

### Corner components

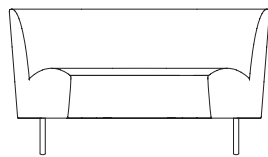
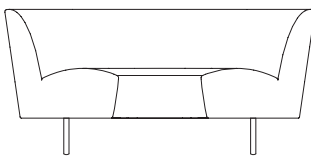

90°

135°

# Loop

---

## Modular system for circular compositions

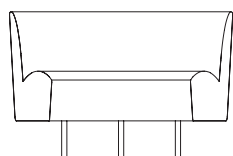

30° concave

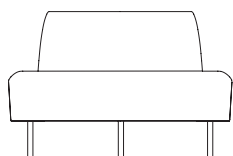

30° convex

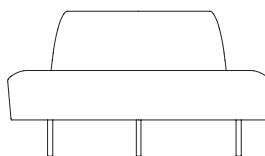

45°

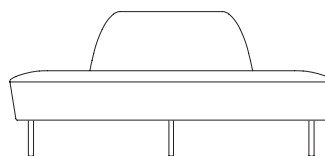

90°

---

## Options



— Polished or powdercoated aluminium feet



— USB



— Cushion

---

A  
ART. 2802 + ART. 2809 + ART. 2805

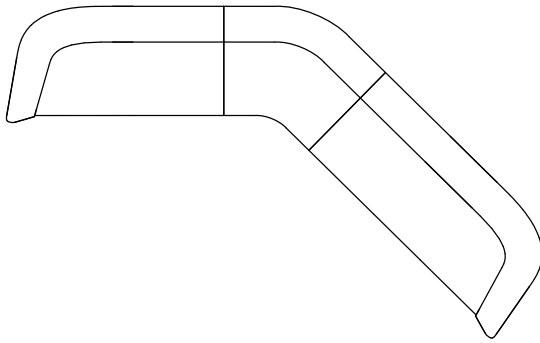

B  
ART. 2802 + ART. 2805

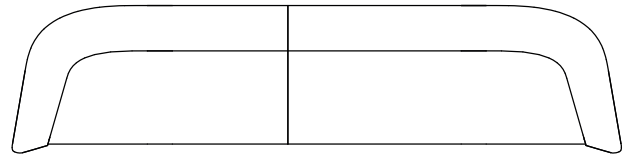

C  
ART. 2802 + ART. 2807 + ART. 2803

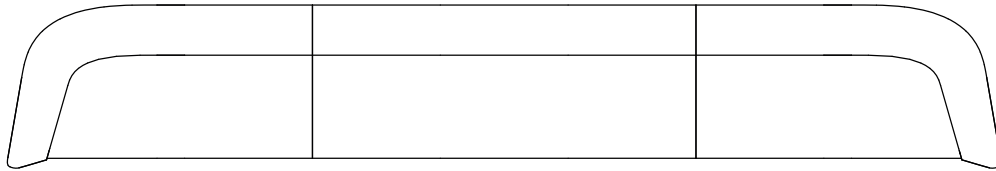

D  
ART. 2804 + ART. 2808 + ART. 2809 + ART. 2807 + ART. 2803

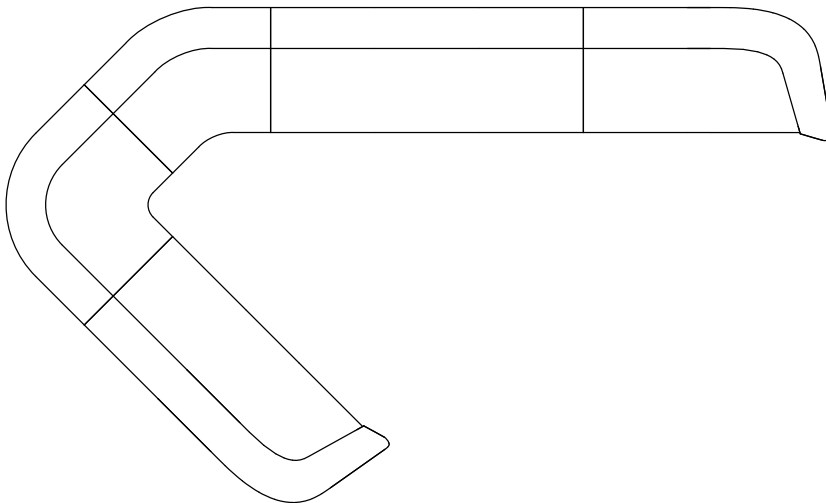

E

1x ART. 2802 + 6x ART. 2820 + 3x ART. 2821 + 2x ART. 2822 + 1x ART. 2803

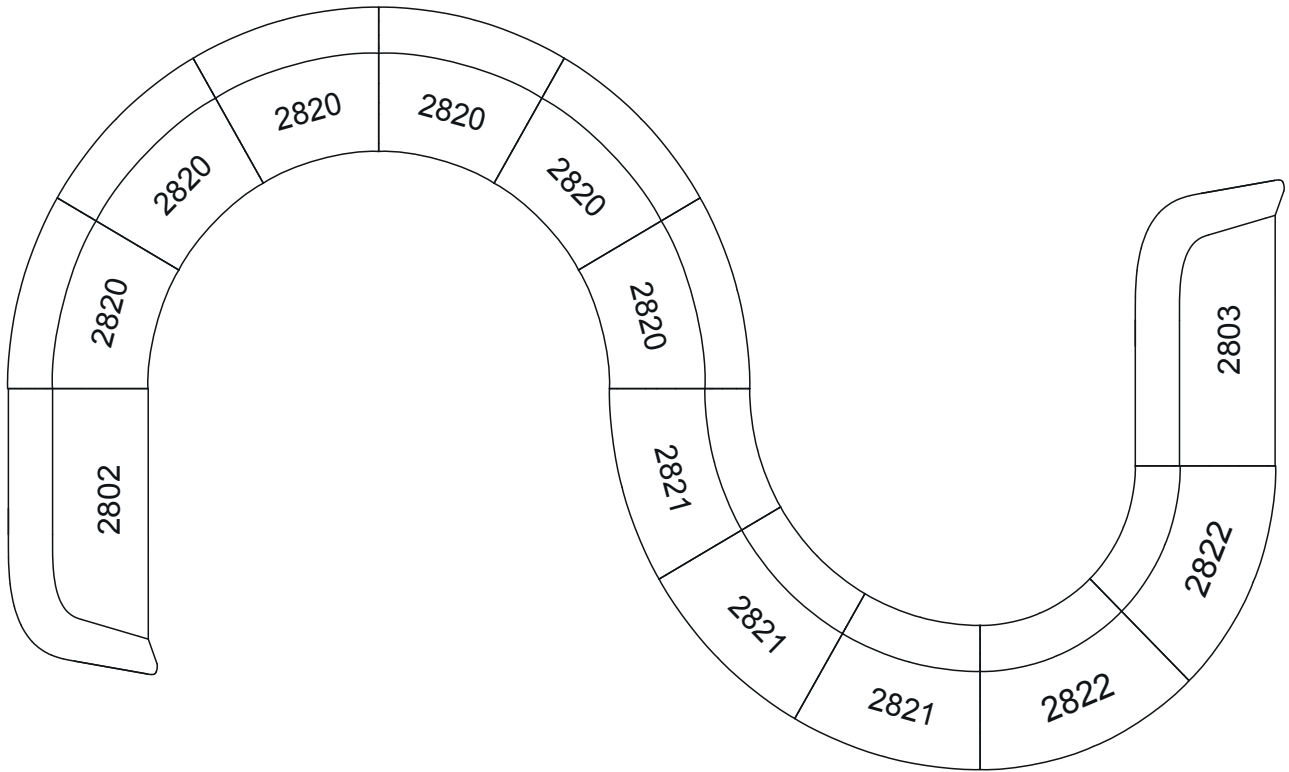

F

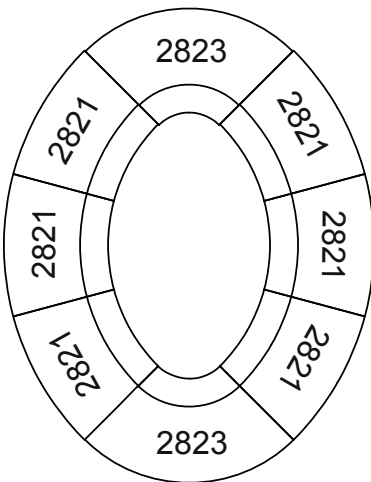

2x ART. 2823 + 6x ART. 2821



G

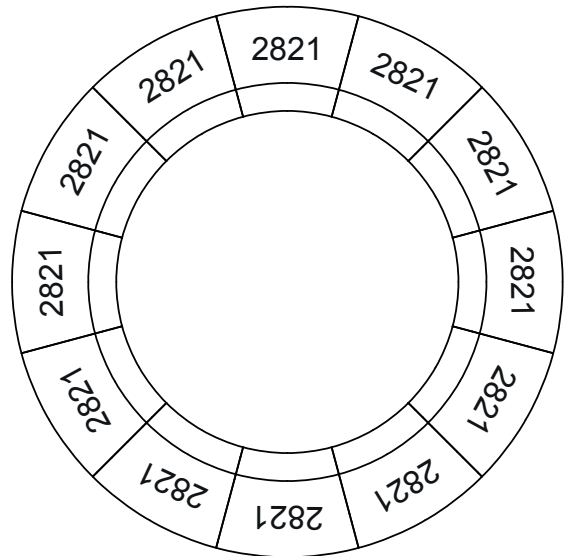

12x ART. 2821

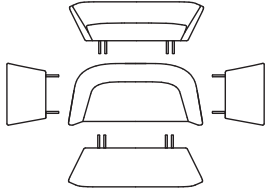
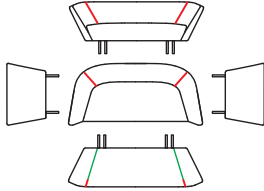
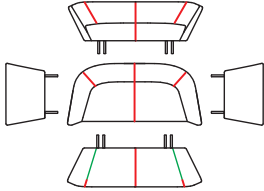
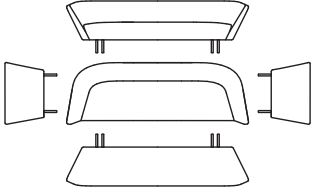
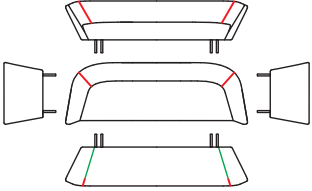
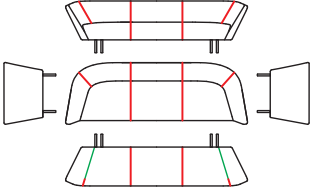
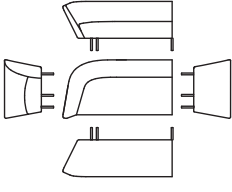
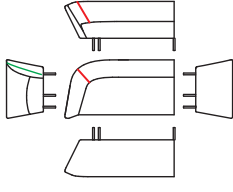
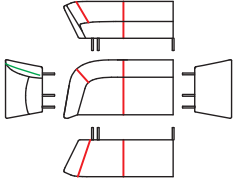
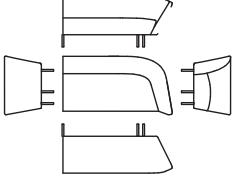
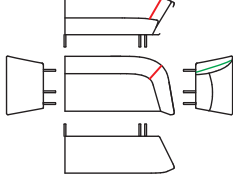
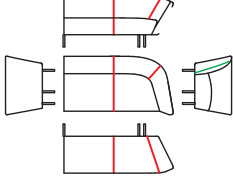
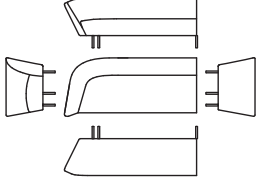
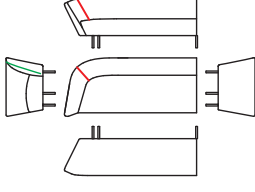
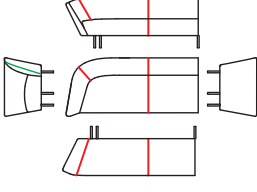
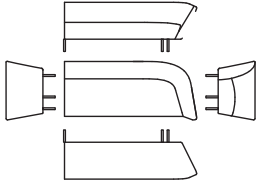
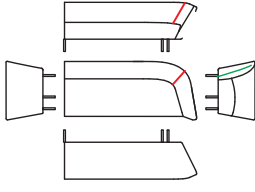
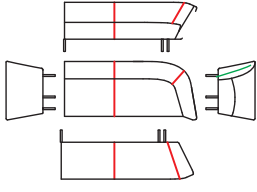
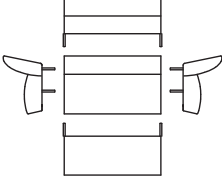
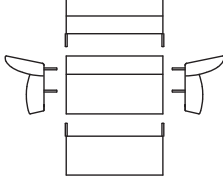
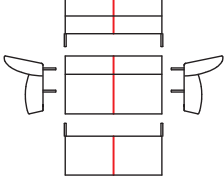

 MODULE SEWING SCHEME  
 MODULE ZIPPER SCHEME

\* Only for: Hallingdal 65 e Tonus 4. The other fabrics will be upholstered same as removable cover scheme.

ART.	Non removable cover	* Removable cover / coated fabric	soft leather
2800			
2801			
2802			
2803			
2804			
2805			
2806			

 MODULE SEWING SCHEME  
 MODULE ZIPPER SCHEME

\* Only for: Hallingdal 65 e Tonus 4. The other fabrics will be upholstered same as removable cover scheme.

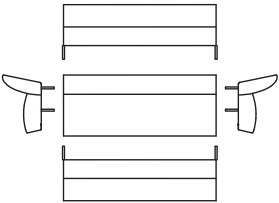
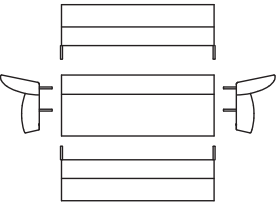
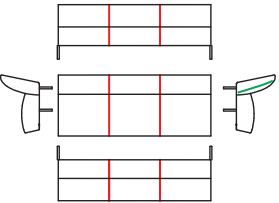
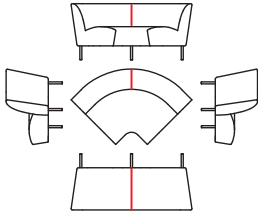
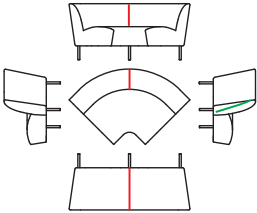
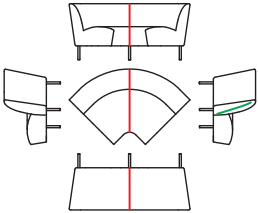
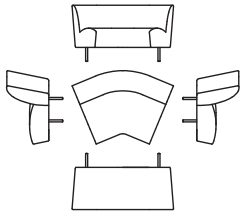
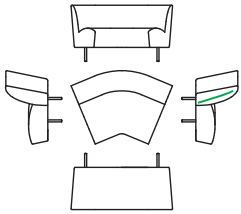
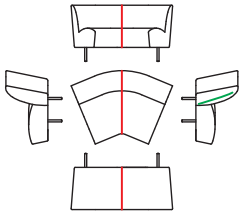
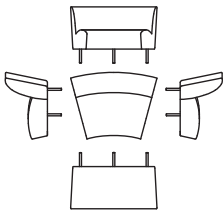
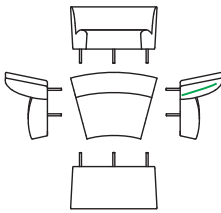
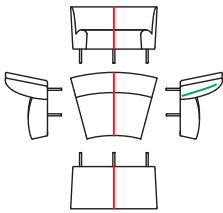
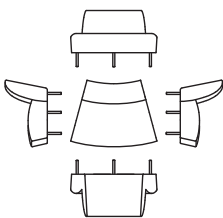
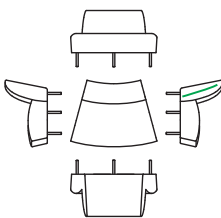
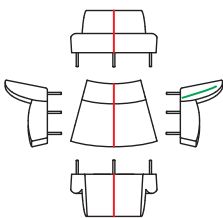
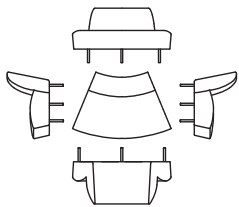
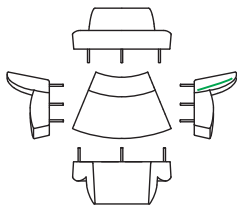
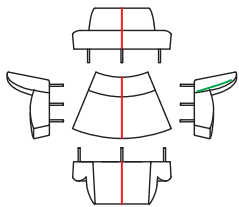
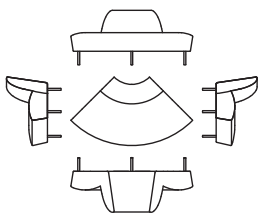
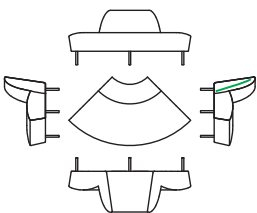
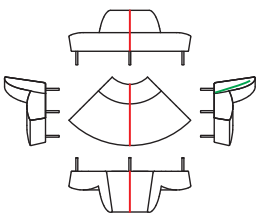
ART.	Non removable cover	* Removable cover / coated fabric	soft leather
2807			
2808			
2809			
2820			
2821			
2822			
2823			



# Loop

Design by Lievore Altherr Molina, 2009



Two seat sofa with wooden frame and stainless steel, polished aluminum or powdercoated feet. Upholstery in fabric, leather, coated fabric or customer's material. Fully removable cover version available upon request without surcharge.

Accessories:  
Replacement cover set Art. 2810  
USB Art. 6001

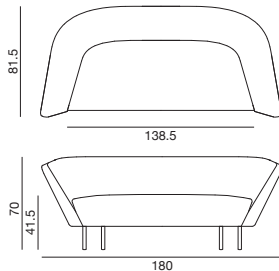

SEK ART. 2800	A	B COM	C COL	D	E	F	G	H	I	J	K	L	M	ES
		28839	30161	31483	32805	34127	35449	36771	38093	39415	40737	42059	43381	44703
Aluminum feet	+ 881	Art. 2800												
Fire retardant foam	+ 2763	Art. 2800												

SHIPMENT DETAILS	TECHNICAL SPECIFICATIONS	RESISTANCE TEST
<b>Art. 2800</b> 1 pz = 1  - kg 55/ m³ 1,195	<b>Art.2800</b> COL requirement m² 10,86 H 140 cm. COM Meterage m 5,17 *Classe 1, 2, 1IM: fire retardant version available with surcharge and eventual minimum batch	<ul style="list-style-type: none"> <li>• EN 1728:2012 - EN 16139:2013 6.10</li> <li>• EN 1728:2012 - EN 16139:2013 6.15</li> <li>• EN 1728:2012 - EN 16139:2013 6.17</li> <li>• EN 1728:2012 - EN 16139:2013 6.20</li> <li>• EN 1728:2012 - EN 16139:2013 6.25</li> <li>• EN 1728:2012 - EN 16139:2013 6.4</li> <li>• EN 1728:2012 - EN 16139:2013 6.6</li> <li>• EN 1022:2018 7.2</li> </ul>
<b>FIRE RETARDANT TEST</b> Classe 1IM Omologazione Italia Field Kvadrat. Steelcut 2 Kvadrat. Coated fabric Valencia Spradling. • FIRE RETARDANT VERSION WITH SURCHARGE • Classe 1IM Omologazione Italia Remix 3 Kvadrat. Steelcut Trio 3 Kvadrat.		

Frame Base

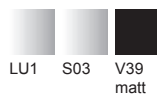

Polished or powdercoated aluminium feet Quick Click

# Loop



Design by Lievore Altherr Molina, 2009

Upholstered three seat sofa with wooden frame and stainless steel or powder-coated feet. Upholstery in fabric, customer's material, leather or coated fabric. Fully removable cover version available upon request without surcharge.

Accessories:

Replacement cover set Art. 2811

USB Art. 6001

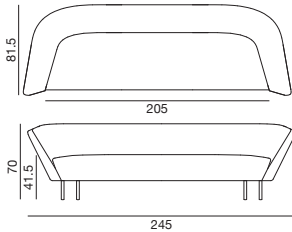

SEK ART. 2801	A	B COM	C COL	D	E	F	G	H	I	J	K	L	M	ES
		32006	33971	35936	37901	39866	41831	43796	45761	47726	49691	51656	53621	55586
Aluminum feet	+ 881	Art. 2801												
Fire retardant foam	+ 3168	Art. 2801												

SHIPMENT DETAILS	TECHNICAL SPECIFICATIONS	RESISTANCE TEST
<b>Art. 2801</b> 1 pz = 1  - kg 80/ m³ 1,524	<b>Art.2801</b> COL requirement m² 14.29 H 140 cm. COM Meterage m 6.61 *Classe 1, 2, 1IM: fire retardant version available with surcharge and eventual minimum batch	<ul style="list-style-type: none"> <li>• EN 1728:2012 - EN 16139:2013 6.10</li> <li>• EN 1728:2012 - EN 16139:2013 6.15</li> <li>• EN 1728:2012 - EN 16139:2013 6.17</li> <li>• EN 1728:2012 - EN 16139:2013 6.20</li> <li>• EN 1728:2012 - EN 16139:2013 6.25</li> <li>• EN 1728:2012 - EN 16139:2013 6.4</li> <li>• EN 1728:2012 - EN 16139:2013 6.6</li> </ul> <ul style="list-style-type: none"> <li>• EN 1728:2012 - EN 16139:2013 6.11</li> <li>• EN 1728:2012 - EN 16139:2013 6.16</li> <li>• EN 1728:2012 - EN 16139:2013 6.18</li> <li>• EN 1728:2012 - EN 16139:2013 6.24</li> <li>• EN 1728:2012 - EN 16139:2013 6.26</li> <li>• EN 1728:2012 - EN 16139:2013 6.5</li> </ul>
<b>FIRE RETARDANT TEST</b> Classe 1IM Omologazione Italia Field Kvadrat. Steelcut 2 Kvadrat. Coated fabric Valencia Spradling. • FIRE RETARDANT VERSION WITH SURCHARGE * Classe 1IM Omologazione Italia Remix 3 Kvadrat. Steelcut Trio 3 Kvadrat.		

Frame Base

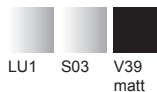

# Loop

Design by Lievore Altherr Molina, 2009

Upholstered modular components. All layouts are to be completed with a component fitted with armrest at each end (see layout examples). It is possible to create layouts fitted with corner components (90° or 135°). Upholstery in fabric, leather, coated fabric or customer's material. Fully removable cover version available upon request without surcharge. Please contact us for customized versions.

Accessories:  
Replacement cover set Art. 2812  
Replacement cover set Art. 2813  
USB Art. 6001

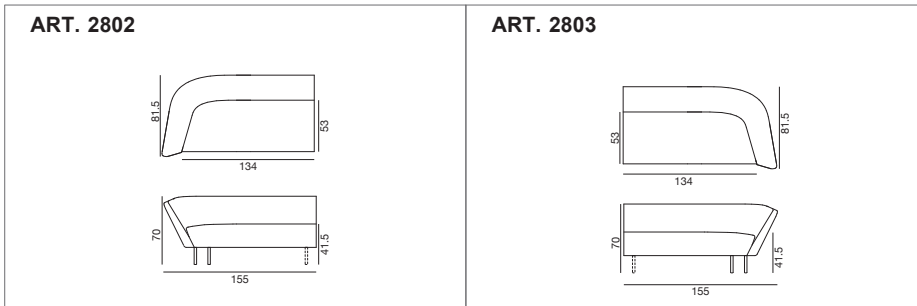

SEK ART. 2802	A	B COM	C COL	D	E	F	G	H	I	J	K	L	M	ES
	28255	29326	30397	31468	32539	33610	34681	35752	36823	37894	38965	40036	41107	45663
SEK ART. 2803	A	B COM	C COL	D	E	F	G	H	I	J	K	L	M	ES
	28255	29326	30397	31468	32539	33610	34681	35752	36823	37894	38965	40036	41107	45663
Fire retardant foam	+ 2524		<b>Art. 2802</b>											
Fire retardant foam	+ 2524		<b>Art. 2803</b>											

SHIPMENT DETAILS	TECHNICAL SPECIFICATIONS	RESISTANCE TEST
<b>Art. 2802</b> 1 pz = 1  - kg 44/ m³ 0,997 <b>Art. 2803</b> 1 pz = 1  - kg 44/ m³ 0,997	<b>Art.2802</b> COL requirement m² 9.44 H 140 cm. COM Meterage m 4.16 *Classe 1, 2, 11M: fire retardant version available with surcharge and eventual minimum batch <b>Art.2803</b> COL requirement m² 9.44 H 140 cm. COM Meterage m 4.16 *Classe 1, 2, 11M: fire retardant version available with surcharge and eventual minimum batch	<ul style="list-style-type: none"> <li>• EN 1728:2012 - EN 16139:2013 6.10</li> <li>• EN 1728:2012 - EN 16139:2013 6.15</li> <li>• EN 1728:2012 - EN 16139:2013 6.17</li> <li>• EN 1728:2012 - EN 16139:2013 6.20</li> <li>• EN 1728:2012 - EN 16139:2013 6.25</li> <li>• EN 1728:2012 - EN 16139:2013 6.4</li> <li>• EN 1728:2012 - EN 16139:2013 6.6</li> </ul> <ul style="list-style-type: none"> <li>• EN 1728:2012 - EN 16139:2013 6.11</li> <li>• EN 1728:2012 - EN 16139:2013 6.16</li> <li>• EN 1728:2012 - EN 16139:2013 6.18</li> <li>• EN 1728:2012 - EN 16139:2013 6.24</li> <li>• EN 1728:2012 - EN 16139:2013 6.26</li> <li>• EN 1728:2012 - EN 16139:2013 6.5</li> </ul>
Classe 11M Omologazione Italia Field Kvadrat. Steelcut 2 Kvadrat. Coated fabric Valencia Spradling. • FIRE RETARDANT VERSION WITH SURCHARGE • Classe 11M Omologazione Italia Remix 3 Kvadrat. Steelcut Trio 3 Kvadrat.		

Frame Base

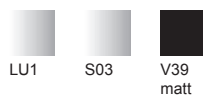

Polished or powdercoated aluminium feet Quick Click



# Loop

Design by Lievore Altherr Molina, 2009

Upholstered modular components. All layouts are to be completed with a component fitted with armrest at each end (see layout examples). It is possible to create layouts fitted with corner components (90° or 135°). Upholstery in fabric, leather, coated fabric or customer's material. Fully removable cover version available upon request without surcharge. Please contact us for customized versions.

Accessories:  
Replacement cover set Art. 2814  
Replacement cover set Art. 2815  
USB Art. 6001

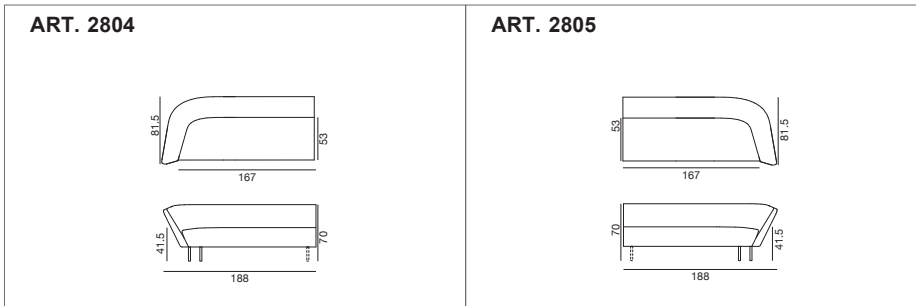

SEK ART. 2804	A	B COM	C COL	D	E	F	G	H	I	J	K	L	M	ES
	30411	32066	33721	35376	37031	38686	40341	41996	43651	45306	46961	48616	50271	57392
SEK ART. 2805	A	B COM	C COL	D	E	F	G	H	I	J	K	L	M	ES
	30411	32066	33721	35376	37031	38686	40341	41996	43651	45306	46961	48616	50271	57392
Fire retardant foam	+ 2691		Art. 2804											
Fire retardant foam	+ 2691		Art. 2805											

SHIPMENT DETAILS	TECHNICAL SPECIFICATIONS	RESISTANCE TEST
<b>Art. 2804</b> 1 pz = 1  - kg 54/ m³ 1,179 <b>Art. 2805</b> 1 pz = 1  - kg 54/ m³ 1,179	<b>Art.2804</b> COL requirement m² 10.66 H 140 cm. COM Meterage m 4.84 *Classe 1, 2, 11M: fire retardant version available with surcharge and eventual minimum batch <b>Art.2805</b> COL requirement m² 10.66 H 140 cm. COM Meterage m 4.84 *Classe 1, 2, 11M: fire retardant version available with surcharge and eventual minimum batch	
Classe 11M Omologazione Italia Field Kvadrat. Steelcut 2 Kvadrat. Coated fabric Valencia Spradling. * FIRE RETARDANT VERSION WITH SURCHARGE * Classe 11M Omologazione Italia Remix 3 Kvadrat. Steelcut Trio 3 Kvadrat.		

Frame Base



Polished or powdercoated aluminium feet Quick Click



# Loop

Design by Lievore Altherr Molina, 2009

Upholstered modular components. All layouts are to be completed with a component fitted with armrest at each end (see layout examples). It is possible to create layouts fitted with corner components (90° or 135°). Upholstery in fabric, leather, coated fabric or customer's material. Fully removable cover version available upon request without surcharge. Please contact us for customized versions.

Accessories:  
Replacement cover set Art. 2816  
Replacement cover set Art. 2817  
USB Art. 6001

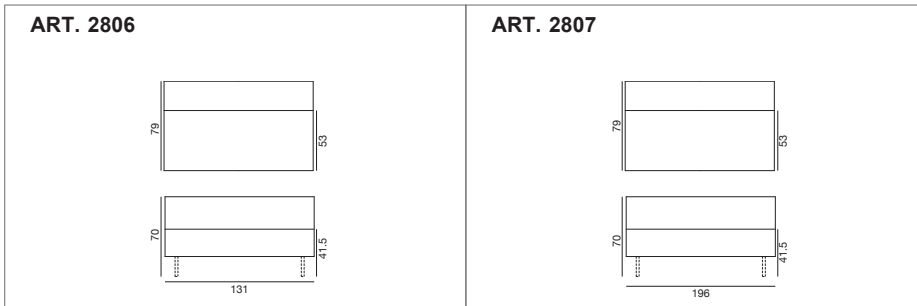

SEK ART. 2806	A	B COM	C COL	D	E	F	G	H	I	J	K	L	M	ES
	22099	23087	24075	25063	26051	27039	28027	29015	30003	30991	31979	32967	33955	38019
SEK ART. 2807	A	B COM	C COL	D	E	F	G	H	I	J	K	L	M	ES
	26374	27981	29588	31195	32802	34409	36016	37623	39230	40837	42444	44051	45658	52605
Fire retardant foam	+ 1869	<b>Art. 2806</b>												
Fire retardant foam	+ 2144	<b>Art. 2807</b>												

SHIPMENT DETAILS	TECHNICAL SPECIFICATIONS	RESISTANCE TEST
<b>Art. 2806</b> 1 pz = 1  - kg 42,5/ m³ 0,755 <b>Art. 2807</b> 1 pz = 1  - kg 64/ m³ 1,1	<b>Art.2806</b> COL requirement m² 7.28 H 140 cm. COM Meterage m 3.54 *Classe 1, 2, 1IM: fire retardant version available with surcharge and eventual minimum batch <b>Art.2807</b> COL requirement m² 9.53 H 140 cm. COM Meterage m 5.01 *Classe 1, 2, 1IM: fire retardant version available with surcharge and eventual minimum batch	
Classe 1IM Omologazione Italia Field Kvadrat. Steelcut 2 Kvadrat. Coated fabric Valencia Spradling. • FIRE RETARDANT VERSION WITH SURCHARGE • Classe 1IM Omologazione Italia Remix 3 Kvadrat. Steelcut Trio 3 Kvadrat.		

Frame Base



Polished or powdercoated aluminium feet Quick Click



# Loop

Design by Lievore Altherr Molina, 2009

Upholstered modular components. All layouts are to be completed with a component fitted with armrest at each end (see layout examples). It is possible to create layouts fitted with corner components (90° or 135°). Upholstery in fabric, leather, coated fabric or customer's material. Fully removable cover version available upon request without surcharge. Please contact us for customized versions.

Accessories:  
Replacement cover set Art. 2818  
Replacement cover set Art. 2819  
USB Art. 6001

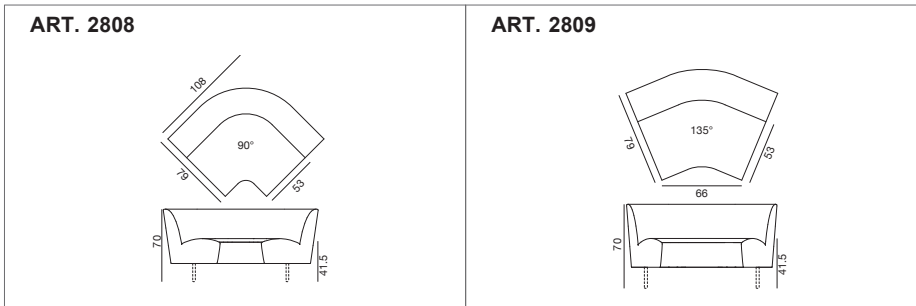

SEK ART. 2808	A	B COM	C COL	D	E	F	G	H	I	J	K	L	M	ES
	26482	27482	28482	29482	30482	31482	32482	33482	34482	35482	36482	37482	38482	42687
SEK ART. 2809	A	B COM	C COL	D	E	F	G	H	I	J	K	L	M	ES
	24219	25041	25863	26685	27507	28329	29151	29973	30795	31617	32439	33261	34083	37460
Fire retardant foam	+	2203	<b>Art. 2808</b>											
Fire retardant foam	+	2119	<b>Art. 2809</b>											

SHIPMENT DETAILS	TECHNICAL SPECIFICATIONS	RESISTANCE TEST
<b>Art. 2808</b> 1 pz = 1  - kg 48/ m² 1,114 <b>Art. 2809</b> 1 pz = 1  - kg 42/ m² 0,899	<b>Art.2808</b> COL requirement m² 7.93 H 140 cm. COM Meterage m 3.96 *Classe 1, 2, 1IM: fire retardant version available with surcharge and eventual minimum batch <b>Art.2809</b> COL requirement m² 6.89 H 140 cm. COM Meterage m 3.81 *Classe 1, 2, 1IM: fire retardant version available with surcharge and eventual minimum batch	<ul style="list-style-type: none"> <li>• EN 1728:2012 - EN 16139:2013 6.17</li> <li>• EN 1728:2012 - EN 16139:2013 6.5</li> <li>• EN 1728:2012 - EN 16139:2013 6.4</li> <li>• EN 1728:2012 - EN 16139:2013 6.5</li> </ul>
Classe 1IM Omologazione Italia Field Kvadrat. Steelcut 2 Kvadrat. Coated fabric Valencia Spradling. * FIRE RETARDANT VERSION WITH SURCHARGE * Classe 1IM Omologazione Italia Remix 3 Kvadrat. Steelcut Trio 3 Kvadrat.		

Frame Base

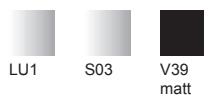

Polished or powdercoated aluminium feet Quick Click



# Loop

Design by Lievore Altherr Molina, 2009

Upholstered modular components. All layouts are to be completed with a component fitted with armrest at each end (see layout examples). It is possible to create layouts fitted with corner components (90° or 135°). Upholstery in fabric, leather, coated fabric or customer's material. Fully removable cover version available upon request without surcharge. Please contact us for customized versions.

Accessories:  
Replacement cover set Art. 2824  
Replacement cover set Art. 2825  
USB Art. 6001

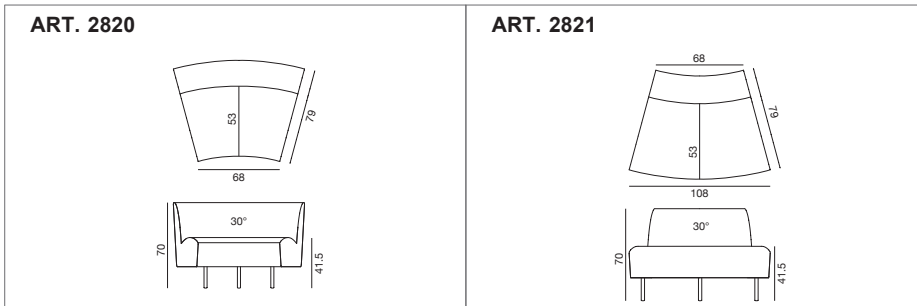

SEK ART. 2820	A	B COM	C COL	D	E	F	G	H	I	J	K	L	M	ES
	24207	25041	25875	26709	27543	28377	29211	30045	30879	31713	32547	33381	34215	37697
SEK ART. 2821	A	B COM	C COL	D	E	F	G	H	I	J	K	L	M	ES
	24302	25088	25874	26660	27446	28232	29018	29804	30590	31376	32162	32948	33734	36792
Fire retardant foam	+ 2119		<b>Art. 2820</b>											
Fire retardant foam	+ 2119		<b>Art. 2821</b>											

SHIPMENT DETAILS	TECHNICAL SPECIFICATIONS	RESISTANCE TEST
<b>Art. 2820</b> 1 pz = 1  - kg 27/ m³ 0,845 <b>Art. 2821</b> 1 pz = 1  - kg 27/ m³ 0,845	<b>Art.2820</b> COL requirement m² 6.5 H 140 cm. COM Meterage m 2.81 *Classe 1, 2, 11M: fire retardant version available with surcharge and eventual minimum batch <b>Art.2821</b> COL requirement m² 6.06 H 140 cm. COM Meterage m 2.64 *Classe 1, 2, 11M: fire retardant version available with surcharge and eventual minimum batch	
Classe 11M Omologazione Italia Field Kvadrat. Steelcut 2 Kvadrat. Coated fabric Valencia Spradling. • FIRE RETARDANT VERSION WITH SURCHARGE • Classe 11M Omologazione Italia Remix 3 Kvadrat. Steelcut Trio 3 Kvadrat.		

Frame Base



Polished or powdercoated aluminium feet Quick Click



# Loop

Design by Lievore Altherr Molina, 2009

Upholstered modular components. All layouts are to be completed with a component fitted with armrest at each end (see layout examples). It is possible to create layouts fitted with corner components (90° or 135°). Upholstery in fabric, leather, coated fabric or customer's material. Fully removable cover version available upon request without surcharge. Please contact us for customized versions.

Accessories:  
Replacement cover set Art. 2826  
Replacement cover set Art. 2827  
USB Art. 6001

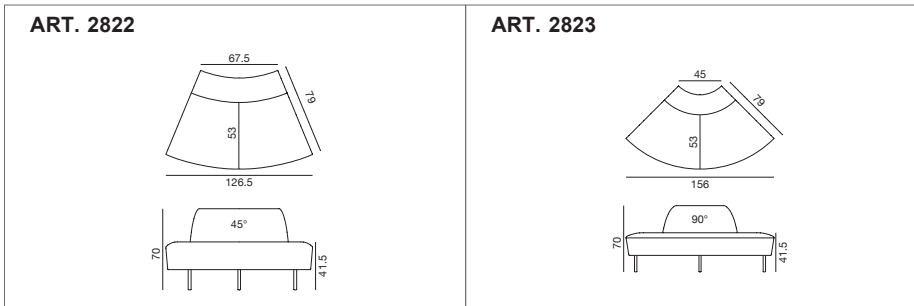

SEK ART. 2822	A	B COM	C COL	D	E	F	G	H	I	J	K	L	M	ES
	24600	25588	26576	27564	28552	29540	30528	31516	32504	33492	34480	35468	36456	40543
SEK ART. 2823	A	B COM	C COL	D	E	F	G	H	I	J	K	L	M	ES
	26589	27577	28565	29553	30541	31529	32517	33505	34493	35481	36469	37457	38445	42531
Fire retardant foam	+	2144	Art. 2822											
Fire retardant foam	+	2203	Art. 2823											

SHIPMENT DETAILS	TECHNICAL SPECIFICATIONS	RESISTANCE TEST
<b>Art. 2822</b> 1 pz = 1  - kg 42/ m² 0,845 <b>Art. 2823</b> 1 pz = 1  - kg 30/ m² 0,845	<b>Art.2822</b> COL requirement m² 6.11 H 140 cm. COM Meterage m 2.88 *Classe 1, 2, 1IM: fire retardant version available with surcharge and eventual minimum batch <b>Art.2823</b> COL requirement m² 6.24 H 140 cm. COM Meterage m 3.17 *Classe 1, 2, 1IM: fire retardant version available with surcharge and eventual minimum batch	
Classe 1IM Omologazione Italia Field Kvadrat. Steelcut 2 Kvadrat. Coated fabric Valencia Spradling. * FIRE RETARDANT VERSION WITH SURCHARGE * Classe 1IM Omologazione Italia Remix 3 Kvadrat. Steelcut Trio 3 Kvadrat.		

Frame Base



Polished or powdercoated aluminium feet Quick Click



arper



# Loop

Design by Lievore Altherr Molina, 2011

Available in two different dimensions with black decorative piping stitched along the edge between back and front side. Upholstery made of down and fiber, upholstered in fabric, coated fabric, leather, COM customer's material.

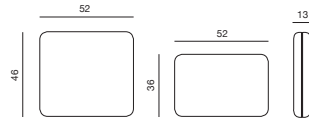

SEK ART. 2828	A	B COM	C COL	D	E	F	G	H	I	J	K	L	M	ES
52x46 cm	1571	1714	1857	2000	2143	2286	2429	2572	2715	2858	3001	3144	3287	3965
SEK ART. 2829	A	B COM	C COL	D	E	F	G	H	I	J	K	L	M	ES
52x36 cm	1405	1548	1691	1834	1977	2120	2263	2406	2549	2692	2835	2978	3121	3810







SHIPMENT DETAILS	TECHNICAL SPECIFICATIONS	RESISTANCE TEST
<b>Art.2828</b> 1 pz = 1  - kg 2/ m³ 0,078 4 pz = 1  - kg 5/ m³ 0,153 <b>Art.2829</b> 1 pz = 1  - kg 2/ m³ 0,078 4 pz = 1  - kg 5/ m³ 0,153	<b>Art.2828</b> COL requirement m² 1.16 H 140 cm. COM Meterage m 0.69 *Classe 1, 2, 11M: fire retardant version available with surcharge and eventual minimum batch <b>Art.2829</b> COL requirement m² 0.9 H 140 cm. COM Meterage m 0.68 *Classe 1, 2, 11M: fire retardant version available with surcharge and eventual minimum batch	
<b>FIRE RETARDANT TEST</b> Classe 11M Omologazione Italia Field Kvadrat, Steelcut 2 Kvadrat, Coated fabric Valencia Spradling. * FIRE RETARDANT VERSION WITH SURCHARGE * Classe 11M Omologazione Italia Steelcut Trio 3 Kvadrat.		



# Accessories

Design by Lievore Altherr Molina, 2009

<b>SEK ART. 2810</b>	<b>A</b>	<b>B COM</b>	<b>C COL</b>	<b>D</b>	<b>E</b>	<b>F</b>	<b>G</b>	<b>H</b>	<b>I</b>	<b>J</b>	<b>K</b>	<b>L</b>	<b>M</b>	<b>ES</b>
SPARE COVER art. 2800	10300	12551	14802	17053	19304	21555	23806	26057	28308	30559	32810	35061	37312	46842
<b>SEK ART. 2811</b>	<b>A</b>	<b>B COM</b>	<b>C COL</b>	<b>D</b>	<b>E</b>	<b>F</b>	<b>G</b>	<b>H</b>	<b>I</b>	<b>J</b>	<b>K</b>	<b>L</b>	<b>M</b>	<b>ES</b>
SPARE COVER art. 2801	12061	14966	17871	20776	23681	26586	29491	32396	35301	38206	41111	44016	46921	59154
<b>SEK ART. 2812</b>	<b>A</b>	<b>B COM</b>	<b>C COL</b>	<b>D</b>	<b>E</b>	<b>F</b>	<b>G</b>	<b>H</b>	<b>I</b>	<b>J</b>	<b>K</b>	<b>L</b>	<b>M</b>	<b>ES</b>
SPARE COVER Art. 2802	10978	12859	14740	16621	18502	20383	22264	24145	26026	27907	29788	31669	33550	41377
<b>SEK ART. 2813</b>	<b>A</b>	<b>B COM</b>	<b>C COL</b>	<b>D</b>	<b>E</b>	<b>F</b>	<b>G</b>	<b>H</b>	<b>I</b>	<b>J</b>	<b>K</b>	<b>L</b>	<b>M</b>	<b>ES</b>
SPARE COVER Art. 2803	10978	12859	14740	16621	18502	20383	22264	24145	26026	27907	29788	31669	33550	41377
<b>SEK ART. 2814</b>	<b>A</b>	<b>B COM</b>	<b>C COL</b>	<b>D</b>	<b>E</b>	<b>F</b>	<b>G</b>	<b>H</b>	<b>I</b>	<b>J</b>	<b>K</b>	<b>L</b>	<b>M</b>	<b>ES</b>
SPARE COVER Art. 2804	12205	14349	16493	18637	20781	22925	25069	27213	29357	31501	33645	35789	37933	47282
<b>SEK ART. 2815</b>	<b>A</b>	<b>B COM</b>	<b>C COL</b>	<b>D</b>	<b>E</b>	<b>F</b>	<b>G</b>	<b>H</b>	<b>I</b>	<b>J</b>	<b>K</b>	<b>L</b>	<b>M</b>	<b>ES</b>
SPARE COVER Art. 2805	12205	14349	16493	18637	20781	22925	25069	27213	29357	31501	33645	35789	37933	47282





SHIPMENT DETAILS	TECHNICAL SPECIFICATIONS	RESISTANCE TEST
<b>Art. 2810</b> 1 pz = 1  - kg 5/ m³ 0,23 <b>Art. 2811</b> 1 pz = 1  - kg 5/ m³ 0,23 <b>Art. 2812</b> 1 pz = 1  - kg 5/ m³ 0,23 <b>Art. 2813</b> 1 pz = 1  - kg 5/ m³ 0,23 <b>Art. 2814</b> 1 pz = 1  - kg 5/ m³ 0,23 <b>Art. 2815</b> 1 pz = 1  - kg 5/ m³ 0,23	<b>Art.2810</b> COL requirement m² 10.86 H 140 cm. COM Meterage m 5.17 <b>Art.2811</b> COL requirement m² 14.29 H 140 cm. COM Meterage m 6.61 <b>Art.2812</b> COL requirement m² 9.44 H 140 cm. COM Meterage m 4.16 <b>Art.2813</b> COL requirement m² 9.44 H 140 cm. COM Meterage m 4.16 <b>Art.2814</b> COL requirement m² 10.66 H 140 cm. COM Meterage m 4.84 <b>Art.2815</b> COL requirement m² 10.66 H 140 cm. COM Meterage m 4.84	
<b>FIRE RETARDANT TEST</b> Classe 1IM Omologazione Italia Field Kvadrat. Steelcut 2 Kvadrat. Coated fabric Valencia Spradling. * FIRE RETARDANT VERSION WITH SURCHARGE * Classe 1IM Omologazione Italia Steelcut Trio 3 Kvadrat.		



# Accessories

Design by Lievore Altherr Molina, 2009

<b>SEK ART. 2816</b>	A	B COM	C COL	D	E	F	G	H	I	J	K	L	M	ES
SPARE COVER Art. 2806	7966	9395	10824	12253	13682	15111	16540	17969	19398	20827	22256	23685	25114	31268
<b>SEK ART. 2817</b>	A	B COM	C COL	D	E	F	G	H	I	J	K	L	M	ES
SPARE COVER Art. 2807	9573	11609	13645	15681	17717	19753	21789	23825	25861	27897	29933	31969	34005	42687
<b>SEK ART. 2818</b>	A	B COM	C COL	D	E	F	G	H	I	J	K	L	M	ES
SPARE COVER Art. 2808	9644	11478	13312	15146	16980	18814	20648	22482	24316	26150	27984	29818	31652	39067
<b>SEK ART. 2819</b>	A	B COM	C COL	D	E	F	G	H	I	J	K	L	M	ES
SPARE COVER Art. 2809	7871	9335	10799	12263	13727	15191	16655	18119	19583	21047	22511	23975	25439	31899





SHIPMENT DETAILS	TECHNICAL SPECIFICATIONS	RESISTANCE TEST
<b>Art. 2816</b> 1 pz = 1  - kg 5/ m³ 0,23 <b>Art. 2817</b> 1 pz = 1  - kg 5/ m³ 0,23 <b>Art. 2818</b> 1 pz = 1  - kg 5/ m³ 0,23 <b>Art. 2819</b> 1 pz = 1  - kg 5/ m³ 0,23	<b>Art.2816</b> COL requirement m² 7.28 H 140 cm. COM Meterage m 3.54 <b>Art.2817</b> COL requirement m² 9.53 H 140 cm. COM Meterage m 5.01 <b>Art.2818</b> COL requirement m² 7.93 H 140 cm. COM Meterage m 3.96 <b>Art.2819</b> COL requirement m² 6.89 H 140 cm. COM Meterage m 3.81	
<b>FIRE RETARDANT TEST</b> Classe 1IM Omologazione Italia Field Kvadrat. Steelcut 2 Kvadrat. Coated fabric Valencia Spradling. • FIRE RETARDANT VERSION WITH SURCHARGE • Classe 1IM Omologazione Italia Steelcut Trio 3 Kvadrat.		



# Accessories

Design by Lievore Altherr Molina, 2009

<b>SEK ART. 2824</b>	A	B COM	C COL	D	E	F	G	H	I	J	K	L	M	ES
SPARE COVER Art. 2820	7871	9335	10799	12263	13727	15191	16655	18119	19583	21047	22511	23975	25439	31899
<b>SEK ART. 2825</b>	A	B COM	C COL	D	E	F	G	H	I	J	K	L	M	ES
SPARE COVER Art. 2821	7871	9335	10799	12263	13727	15191	16655	18119	19583	21047	22511	23975	25439	31899
<b>SEK ART. 2826</b>	A	B COM	C COL	D	E	F	G	H	I	J	K	L	M	ES
SPARE COVER Art. 2822	9728	11014	12300	13586	14872	16158	17444	18730	20016	21302	22588	23874	25160	30327
<b>SEK ART. 2827</b>	A	B COM	C COL	D	E	F	G	H	I	J	K	L	M	ES
SPARE COVER Art. 2823	10336	11979	13622	15265	16908	18551	20194	21837	23480	25123	26766	28409	30052	37079

SHIPMENT DETAILS	TECHNICAL SPECIFICATIONS	RESISTANCE TEST
<b>Art. 2824</b> 1 pz = 1  - kg 5/ m³ 0,23 <b>Art. 2825</b> 1 pz = 1  - kg 5/ m³ 0,23 <b>Art. 2826</b> 1 pz = 1  - kg 5/ m³ 0,23 <b>Art. 2827</b> 1 pz = 1  - kg 5/ m³ 0,23	<b>Art.2824</b> COL requirement m² 6.5 H 140 cm. COM Meterage m 2.81 <b>Art.2825</b> COL requirement m² 6.06 H 140 cm. COM Meterage m 2.64 <b>Art.2826</b> COL requirement m² 6.11 H 140 cm. COM Meterage m 2.88 <b>Art.2827</b> COL requirement m² 6.24 H 140 cm. COM Meterage m 3.17	
<b>FIRE RETARDANT TEST</b> Classe 1IM Omologazione Italia Field Kvadrat, Steelcut 2 Kvadrat, Coated fabric Valencia Spradling. • FIRE RETARDANT VERSION WITH SURCHARGE * Classe 1IM Omologazione Italia Steelcut Trio 3 Kvadrat.		



## Accessories

### **SEK ART. 6001**



Power supply kit consisting of 2 units with 2 USB A sockets each, 1 power supply unit and cable clamps. Electric cable not included.

1655

SHIPMENT DETAILS	TECHNICAL SPECIFICATIONS	RESISTANCE TEST
<b>FIRE RETARDANT TEST</b>		



# PIX

Design by Ichiro Iwasaki

2014

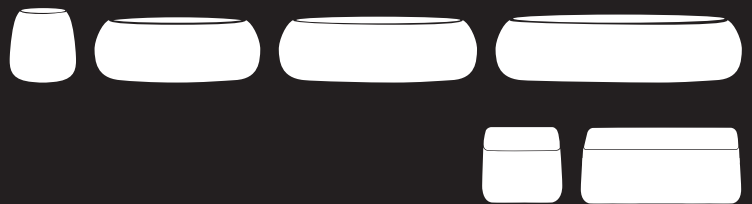

# Pix

## Collection overview

### Type



1 seat



1 seat



1 seat



1 seat



2 seats



3 seats



5 seats



1 seat



2 seats

### Upholstery



Upholstered and covered  
in fabric, leather or coated  
fabric

### Sewing scheme

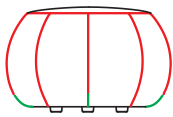

Pix

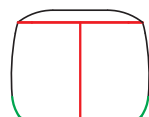

Pix Cubo



Outdoor

# Pix

Design by Ichiro Iwasaki, 2014

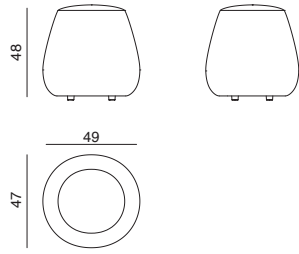

One seat ottoman. Upholstery in leather, coated fabric, fabric or customer's own material. Available in outdoor version thanks to a water-repellent inner lining in coated polyester. Fitted with glides. 49 cm diameter and 48 cm height.

Accessories:  
Replacement cover set Art. 3016

SEK ART. 3013	A	B COM	C COL	D	E	F	G	H	I	J	K	L	M	ES
	5370	5763	6156	6549	6942	7335	7728	8121	8514	8907	9300	9693	10086	11490
<b>SEK ART. 3028</b>	COM Silvertex	Heritage Savane	Patio											
OUTDOOR	7085	7478	7871											
Removable cover	+ 536 Art. 3013													
Fire retardant foam	+ 83 Art. 3013													
SHIPMENT DETAILS	TECHNICAL SPECIFICATIONS			RESISTANCE TEST										
<b>Art.3013</b> 1 pz = 1  - kg 5,92/ m³ 0,208 <b>Art.3028</b> 1 pz = 1  - kg 5,92/ m³ 0,208	<b>Art.3013</b> COL requirement m² 2.4 H 140 cm. COM Meterage m 1.32 <b>Art.3028</b> H 140 cm. COM Meterage m 1.32			<ul style="list-style-type: none"> <li>• EN 1728:2012 - EN 16139:2013 6.17</li> <li>• EN 1728:2012 - EN 16139:2013 6.24</li> <li>• EN 1728:2012 - EN 16139:2013 6.5</li> <li>• EN 1728:2012 - EN 16139:2013 6.18</li> <li>• EN 1728:2012 - EN 16139:2013 6.4</li> </ul>										
FIRE RETARDANT TEST														
Classe 1IM Omologazione Italia Canvas 2 Kvadrat. Divina MD Kvadrat. Divina Melange 3 Kvadrat. Divina 3 Kvadrat. Field Kvadrat. Hallingdal 65 Kvadrat. Remix 3 Kvadrat. Steelcut 2 Kvadrat. Tonus 4 Kvadrat. Coated fabric Valencia Spradling.														



Outdoor use





# Pix

Design by Ichiro Iwasaki, 2014

One seat low ottoman. Upholstery in leather, coated fabric, fabric or customer's own material. Available in outdoor version thanks to a water-repellent inner lining in coated polyester. Fitted with glides. 55 cm diameter and 32 cm height.

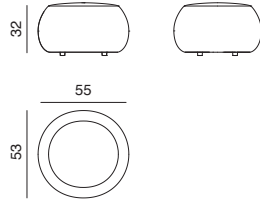

Accessories:  
Replacement cover set Art. 3014

SEK ART. 3011	A	B COM	C COL	D	E	F	G	H	I	J	K	L	M	ES
	5180	5549	5918	6287	6656	7025	7394	7763	8132	8501	8870	9239	9608	11073
<b>SEK ART. 3026</b>	COM Silvertex	Heritage Savane	Patio											
OUTDOOR	6668	7037	7406											
Removable cover	+ 464	Art. 3011												
Fire retardant foam	+ 71	Art. 3011												
<b>SHIPMENT DETAILS</b>	<b>TECHNICAL SPECIFICATIONS</b>				<b>RESISTANCE TEST</b>									
<b>Art.3011</b> 1 pz = 1  - kg 5,3/ m³ 0,121 <b>Art.3026</b> 1 pz = 1  - kg 5,3/ m³ 0,121	<b>Art.3011</b> COL requirement m² 2.04 H 140 cm. COM Meterage m 1.1 <b>Art.3026</b> H 140 cm. COM Meterage m 1.1													
<b>FIRE RETARDANT TEST</b>														
Classe 1IM Omologazione Italia Canvas 2 Kvadrat. Divina MD Kvadrat. Divina Melange 3 Kvadrat. Divina 3 Kvadrat. Field Kvadrat. Hallingdal 65 Kvadrat. Remix 3 Kvadrat. Steelcut 2 Kvadrat. Tonus 4 Kvadrat. Coated fabric Valencia Spradling.														



Outdoor use



# Pix

Design by Ichiro Iwasaki, 2010

One small seat ottoman. Upholstery available in fabric, leather, coated fabric or customer's material. Available in outdoor version thanks to a water-repellent inner lining in coated polyester. Fitted with glides. 67 cm diameter and 43 cm height.

Accessories:  
Replacement cover set Art. 3004

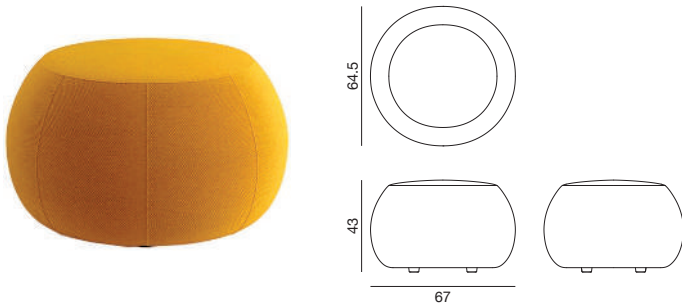

SEK ART. 3000	A	B COM	C COL	D	E	F	G	H	I	J	K	L	M	ES
	6322	6691	7060	7429	7798	8167	8536	8905	9274	9643	10012	10381	10750	12205
<b>SEK ART. 3022</b>	COM Silvertex	Heritage Savane	Patio											
OUTDOOR	8252	8621	8990											
Removable cover	+ 893	Art. 3000												
Fire retardant foam	+ 95	Art. 3000												
<b>SHIPMENT DETAILS</b>	<b>TECHNICAL SPECIFICATIONS</b>				<b>RESISTANCE TEST</b>									
<b>Art.3000</b> 1 pz = 1  - kg 8/ m³ 0,215	<b>Art.3000</b> COL requirement m² 2.7 H 140 cm. COM Meterage m 1.65													
<b>Art.3022</b> 1 pz = 1  - kg 8/ m³ 0,215	<b>Art.3022</b> H 140 cm. COM Meterage m 1.6													
<b>FIRE RETARDANT TEST</b>														
Classe 1IM Omologazione Italia Canvas 2 Kvadrat. Divina MD Kvadrat. Divina Melange 3 Kvadrat. Divina 3 Kvadrat. Field Kvadrat. Hallingdal 65 Kvadrat. Remix 3 Kvadrat. Steelcut 2 Kvadrat. Tonus 4 Kvadrat. Coated fabric Valencia Spradling.														



Outdoor use



# Pix

Design by Ichiro Iwasaki, 2010

One large seat ottoman. Upholstery available in fabric, leather, coated fabric or customer's material. Available in outdoor version thanks to a water-repellent inner lining in coated polyester. Fitted with glides. 87 cm diameter and 43 cm height.

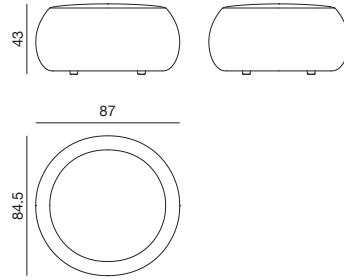

Accessories:  
Replacement cover set Art. 3005

SEK ART. 3001	A	B COM	C COL	D	E	F	G	H	I	J	K	L	M	ES
	8073	8621	9169	9717	10265	10813	11361	11909	12457	13005	13553	14101	14649	16884
<b>SEK ART. 3023</b>	COM Silvertex	Heritage Savane	Patio											
OUTDOOR	10669	11217	11765											
Removable cover	+ 1286	Art. 3001												
Fire retardant foam	+ 202	Art. 3001												
<b>SHIPMENT DETAILS</b>	<b>TECHNICAL SPECIFICATIONS</b>				<b>RESISTANCE TEST</b>									
<b>Art.3001</b> 1 pz = 1  - kg 15/ m³ 0,395 <b>Art.3023</b> 1 pz = 1  - kg 15/ m³ 0,395	<b>Art.3001</b> COL requirement m² 3.3 H 140 cm. COM Meterage m 2.31 <b>Art.3023</b> H 140 cm. COM Meterage m 2.2				<ul style="list-style-type: none"> <li>• EN 1728:2012 - EN 16139:2013 6.17</li> <li>• EN 1728:2012 - EN 16139:2013 6.24</li> <li>• EN 1728:2012 - EN 16139:2013 6.5</li> </ul>					<ul style="list-style-type: none"> <li>• EN 1728:2012 - EN 16139:2013 6.18</li> <li>• EN 1728:2012 - EN 16139:2013 6.4</li> </ul>				
<b>FIRE RETARDANT TEST</b>														
Classe 1IM Omologazione Italia Canvas 2 Kvadrat. Divina MD Kvadrat. Divina Melange 3 Kvadrat. Divina 3 Kvadrat. Field Kvadrat. Hallingdal 65 Kvadrat. Remix 3 Kvadrat. Steelcut 2 Kvadrat. Tonus 4 Kvadrat. Coated fabric Valencia Spradling.														



Outdoor use



# Pix

Design by Ichiro Iwasaki, 2014

Two seat low ottoman. Upholstery in leather, coated fabric, fabric or customer's own material. Available in outdoor version thanks to a water-repellent inner lining in coated polyester. Fitted with glides. 95 cm diameter and 32 cm height.

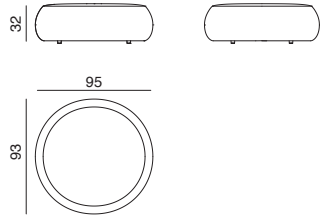

Accessories:  
Replacement cover set Art. 3015

SEK ART. 3012	A	B COM	C COL	D	E	F	G	H	I	J	K	L	M	ES
	9156	9704	10252	10800	11348	11896	12444	12992	13540	14088	14636	15184	15732	17980
<b>SEK ART. 3027</b>	COM Silvertex	Heritage Savane	Patio											
OUTDOOR	11812	12360	12908											
Removable cover	+ 1095	Art. 3012												
Fire retardant foam	+ 166	Art. 3012												
<b>SHIPMENT DETAILS</b>	<b>TECHNICAL SPECIFICATIONS</b>				<b>RESISTANCE TEST</b>									
Art.3012 1 pz = 1  - kg 12,5/ m³ 0,346	Art.3012 COL requirement m² 3.3 H 140 cm. COM Meterage m 1.93													
Art.3027 1 pz = 1  - kg 12,5/ m³ 0,346	Art.3027 H 140 cm. COM Meterage m 1.87													
<b>FIRE RETARDANT TEST</b>														
Classe 1IM Omologazione Italia Canvas 2 Kvadrat. Divina MD Kvadrat. Divina Melange 3 Kvadrat. Divina 3 Kvadrat. Field Kvadrat. Hallingdal 65 Kvadrat. Remix 3 Kvadrat. Steelcut 2 Kvadrat. Tonus 4 Kvadrat. Coated fabric Valencia Spradling.														



Outdoor use



# Pix

Design by Ichiro Iwasaki, 2010

Three seater ottoman. Upholstery available in fabric, leather, coated fabric or customer's material. Available in outdoor version thanks to a water-repellent inner lining in coated polyester. Fitted with glides. 137 cm diameter and 44,5 cm height.

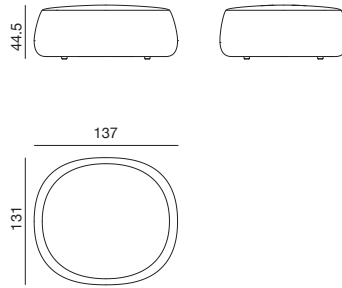

Accessories:  
Replacement cover set Art. 3006

SEK ART. 3002	A	B COM	C COL	D	E	F	G	H	I	J	K	L	M	ES
	17158	18087	19016	19945	20874	21803	22732	23661	24590	25519	26448	27377	28306	32351
<b>SEK ART. 3024</b>	COM Silvertex	Heritage Savane	Patio											
OUTDOOR	22433	23362	24291											
Removable cover	+ 1988	Art. 3002												
Fire retardant foam	+ 512	Art. 3002												
<b>SHIPMENT DETAILS</b>	<b>TECHNICAL SPECIFICATIONS</b>				<b>RESISTANCE TEST</b>									
<b>Art.3002</b> 1 pz = 1  - kg 36/ m³ 0,942 <b>Art.3024</b> 1 pz = 1  - kg 36/ m³ 0,942	<b>Art.3002</b> COL requirement m² 7.8 H 140 cm. COM Meterage m 3.69 <b>Art.3024</b> H 140 cm. COM Meterage m 3.69													
<b>FIRE RETARDANT TEST</b>														
Classe 1IM Omologazione Italia Canvas 2 Kvadrat. Divina MD Kvadrat. Divina Melange 3 Kvadrat. Divina 3 Kvadrat. Field Kvadrat. Hallingdal 65 Kvadrat. Remix 3 Kvadrat. Steelcut 2 Kvadrat. Tonus 4 Kvadrat. Coated fabric Valencia Spradling.														



Outdoor use



# Pix

Design by Ichiro Iwasaki, 2010

Five seater ottoman. Upholstery available in fabric, leather, coated fabric or customer's material. Available in outdoor version thanks to a water-repellent inner lining in coated polyester. Fitted with glides. 177 cm diameter and 45,5 cm height.

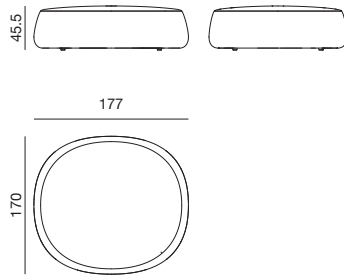

Accessories:  
Replacement cover set Art. 3007

SEK ART. 3003	A	B COM	C COL	D	E	F	G	H	I	J	K	L	M	ES
	20670	22004	23338	24672	26006	27340	28674	30008	31342	32676	34010	35344	36678	42020
<b>SEK ART. 3025</b>	COM Silvertex	Heritage Savane	Patio											
OUTDOOR	27768	29102	30436											
Removable cover	+ 3548	Art. 3003												
Fire retardant foam	+ 1071	Art. 3003												
<b>SHIPMENT DETAILS</b>	<b>TECHNICAL SPECIFICATIONS</b>			<b>RESISTANCE TEST</b>										
<b>Art.3003</b> 1 pz = 1  - kg 60/ m³ 1,6	<b>Art.3003</b> COL requirement m² 9.96 H 140 cm. COM Meterage m 5.67			<ul style="list-style-type: none"> <li>• EN 1728:2012 - EN 16139:2013 6.17</li> <li>• EN 1728:2012 - EN 16139:2013 6.24</li> <li>• EN 1728:2012 - EN 16139:2013 6.5</li> </ul>						<ul style="list-style-type: none"> <li>• EN 1728:2012 - EN 16139:2013 6.18</li> <li>• EN 1728:2012 - EN 16139:2013 6.4</li> <li>• EN 1022:2018</li> </ul>				
<b>Art.3025</b> 1 pz = 1  - kg 60/ m³ 1,6	<b>Art.3025</b> H 140 cm. COM Meterage m 4.95													
<b>FIRE RETARDANT TEST</b>														
Classe 1IM Omologazione Italia Canvas 2 Kvadrat. Divina MD Kvadrat. Divina Melange 3 Kvadrat. Divina 3 Kvadrat. Field Kvadrat. Hallingdal 65 Kvadrat. Remix 3 Kvadrat. Steelcut 2 Kvadrat. Tonus 4 Kvadrat. Coated fabric Valencia Spradling.														



Outdoor use



# Pix Cubo

Design by Ichiro Iwasaki, 2018

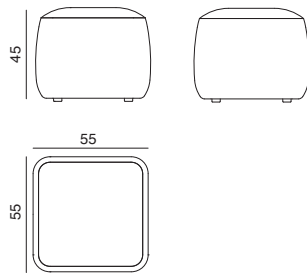

One-seat ottoman. Upholstery in fabric, leather, coated fabric or customer's fabric or leather. Available in outdoor version thanks to a water-repellent inner lining in coated polyester. Fitted with glides. 55x55 cm surface and 45 cm height.

Accessories:  
Replacement cover set Art. 3019  
Connection kit (Pix Cubo) Art. 3021

SEK ART. 3017	A	B COM	C COL	D	E	F	G	H	I	J	K	L	M	ES
	6322	6691	7060	7429	7798	8167	8536	8905	9274	9643	10012	10381	10750	12205
<b>SEK ART. 3029</b>	COM Silvertex	Heritage Savane	Patio											
OUTDOOR	8371	8740	9109											
Removable cover	+ 893	Art. 3017												
Fire retardant foam	+ 95	Art. 3017												
<b>SHIPMENT DETAILS</b>	<b>TECHNICAL SPECIFICATIONS</b>				<b>RESISTANCE TEST</b>									
Art.3017 1 pz = 1  - kg 5/ m² 0,211	Art.3017 COL requirement m² 3.08 H 140 cm. COM Meterage m 1.72													
Art.3029 1 pz = 1  - kg 5/ m² 0,211	Art.3029 H 140 cm. COM Meterage m 1.72													
<b>FIRE RETARDANT TEST</b>														
Classe 1IM Omologazione Italia Canvas 2 Kvadrat. Field Kvadrat. Hallingdal 65 Kvadrat. Steelcut 2 Kvadrat. Tonus 4 Kvadrat. Coated fabric Valencia Spradling.														



Outdoor use



# Pix Cubo

Design by Ichiro Iwasaki, 2018

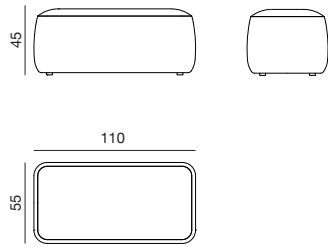

Two-seat ottoman. Upholstery in fabric, leather, coated fabric or customer's fabric or leather. Available in outdoor version thanks to a water-repellent inner lining in coated polyester. Fitted with glides. 110x55 cm surface and 45 cm height.

Accessories:  
Replacement cover set Art. 3020  
Connection kit (Pix Cubo) Art. 3021

SEK ART. 3018	A	B COM	C COL	D	E	F	G	H	I	J	K	L	M	ES
	9859	10407	10955	11503	12051	12599	13147	13695	14243	14791	15339	15887	16435	18694
<b>SEK ART. 3030</b>	COM Silvertex	Heritage Savane	Patio											
OUTDOOR	12645	13193	13741											
Removable cover	+ 1095 <b>Art. 3018</b>													
Fire retardant foam	+ 166 <b>Art. 3018</b>													
<b>SHIPMENT DETAILS</b>	<b>TECHNICAL SPECIFICATIONS</b>				<b>RESISTANCE TEST</b>									
<b>Art.3018</b> 1 pz = 1  - kg 11,5/ m³ 0,421 <b>Art.3030</b> 1 pz = 1  - kg 11,5/ m³ 0,421	<b>Art.3018</b> COL requirement m² 4 H 140 cm. COM Meterage m 2.24  <b>Art.3030</b> H 140 cm. COM Meterage m 2.24				<ul style="list-style-type: none"> <li>• EN 1728:2012 - EN 16139:2013 6.15</li> <li>• EN 1728:2012 - EN 16139:2013 6.17</li> <li>• EN 1728:2012 - EN 16139:2013 6.24</li> <li>• EN 1728:2012 - EN 16139:2013 6.5</li> </ul>					<ul style="list-style-type: none"> <li>• EN 1728:2012 - EN 16139:2013 6.16</li> <li>• EN 1728:2012 - EN 16139:2013 6.18</li> <li>• EN 1728:2012 - EN 16139:2013 6.4</li> </ul>				
<b>FIRE RETARDANT TEST</b>														
Classe 1IM Omologazione Italia Canvas 2 Kvadrat. Field Kvadrat. Hallingdal 65 Kvadrat. Steelcut 2 Kvadrat. Tonus 4 Kvadrat. Coated fabric Valencia Spradling.														



Outdoor use









# Accessories

Design by Ichiro Iwasaki, 2010

<b>SEK ART. 3004</b>	A	B COM	C COL	D	E	F	G	H	I	J	K	L	M	ES
SPARE COVER art. 3000	3500	3976	4452	4928	5404	5880	6356	6832	7308	7784	8260	8736	9212	10848
<b>SEK ART. 3005</b>	A	B COM	C COL	D	E	F	G	H	I	J	K	L	M	ES
SPARE COVER art. 3001	3798	4464	5130	5796	6462	7128	7794	8460	9126	9792	10458	11124	11790	14836
<b>SEK ART. 3014</b>	A	B COM	C COL	D	E	F	G	H	I	J	K	L	M	ES
SPARE COVER art. 3011	2012	2441	2870	3299	3728	4157	4586	5015	5444	5873	6302	6731	7160	8632
<b>SEK ART. 3015</b>	A	B COM	C COL	D	E	F	G	H	I	J	K	L	M	ES
SPARE COVER art. 3012	2988	3607	4226	4845	5464	6083	6702	7321	7940	8559	9178	9797	10416	13050
<b>SEK ART. 3016</b>	A	B COM	C COL	D	E	F	G	H	I	J	K	L	M	ES
SPARE COVER art. 3013	2239	2703	3167	3631	4095	4559	5023	5487	5951	6415	6879	7343	7807	9336





SHIPMENT DETAILS	TECHNICAL SPECIFICATIONS	RESISTANCE TEST
<b>Art. 3004</b> 1 pz = 1  - kg 5/ m³ 0,037 <b>Art. 3005</b> 1 pz = 1  - kg 5/ m³ 0,037 <b>Art. 3014</b> 1 pz = 1  - kg 5/ m³ 0,037 <b>Art. 3015</b> 1 pz = 1  - kg 5/ m³ 0,04 <b>Art. 3016</b> 1 pz = 1  - kg 5/ m³ 0,04	<b>Art.3004</b> COL requirement m² 2.7 H 140 cm. COM Meterage m 1.65 <b>Art.3005</b> COL requirement m² 3.3 H 140 cm. COM Meterage m 2.31 <b>Art.3014</b> COL requirement m² 2.04 H 140 cm. COM Meterage m 1.1 <b>Art.3015</b> COL requirement m² 3.3 H 140 cm. COM Meterage m 1.93 <b>Art.3016</b> COL requirement m² 2.4 H 140 cm. COM Meterage m 1.32	
<b>FIRE RETARDANT TEST</b>		



# Accessories

Design by Ichiro Iwasaki, 2010

<b>SEK ART. 3006</b>	A	B COM	C COL	D	E	F	G	H	I	J	K	L	M	ES
SPARE COVER art. 3002	5453	6489	7525	8561	9597	10633	11669	12705	13741	14777	15813	16849	17885	22361
<b>SEK ART. 3007</b>	A	B COM	C COL	D	E	F	G	H	I	J	K	L	M	ES
SPARE COVER art. 3003	7109	8752	10395	12038	13681	15324	16967	18610	20253	21896	23539	25182	26825	33828
<b>SEK ART. 3019</b>	A	B COM	C COL	D	E	F	G	H	I	J	K	L	M	ES
SPARE COVER art. 3017	3500	3976	4452	4928	5404	5880	6356	6832	7308	7784	8260	8736	9212	10848
<b>SEK ART. 3020</b>	A	B COM	C COL	D	E	F	G	H	I	J	K	L	M	ES
SPARE COVER art. 3018	3680	4299	4918	5537	6156	6775	7394	8013	8632	9251	9870	10489	11108	13753

SHIPMENT DETAILS	TECHNICAL SPECIFICATIONS	RESISTANCE TEST
<p><b>Art. 3006</b> 1 pz = 1  - kg 5/ m³ 0,209</p> <p><b>Art. 3007</b> 1 pz = 1  - kg 5/ m³ 0,209</p> <p><b>Art. 3019</b> 1 pz = 1  - kg 5/ m³ 0,037</p> <p><b>Art. 3020</b> 1 pz = 1  - kg 5/ m³ 0,037</p>	<p><b>Art.3006</b> COL requirement m² 7.8 H 140 cm. COM Meterage m 3.7</p> <p><b>Art.3007</b> COL requirement m² 9.96 H 140 cm. COM Meterage m 5.67</p> <p><b>Art.3019</b> COL requirement m² 3.08 H 140 cm. COM Meterage m 1.72</p> <p><b>Art.3020</b> COL requirement m² 4 H 140 cm. COM Meterage m 2.24</p>	
<b>FIRE RETARDANT TEST</b>		



# Accessories

Design by Ichiro Iwasaki

## SEK ART. 3021



Connection kit to link two Pix Cubo elements.

357

SHIPMENT DETAILS	TECHNICAL SPECIFICATIONS	RESISTANCE TEST
<b>Art. 3021</b> 1 pz = 1  - kg 0,7/ m³ 0,005		
<b>FIRE RETARDANT TEST</b>		



# RALIK

Design by Ichiro Iwasaki

2023

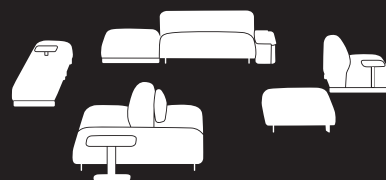

# Ralik

## Collection overview

---

### Seating modules



1-seater ottoman module



1-seater ottoman module with backrest



2-seater ottoman module



2-seater ottoman module with backrest



1-seater bench module



2-seater bench module

# Ralik

---

## Storage modules



Storage module L. 55,5 cm



Storage module L. 85,5 cm

---

## Table modules



Fixed table module



Freestanding height adjustable side table module

---

## Options



USB

# Ralik

## Cushions

---



— Cushion for 1-seater bench

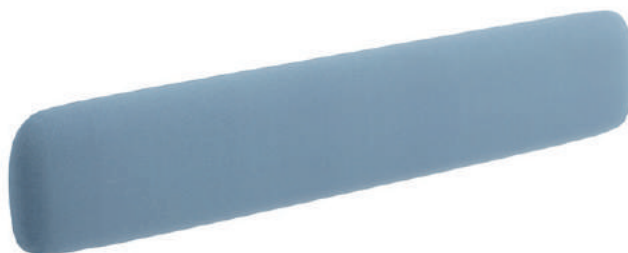

— Cushion for 2-seater bench

---

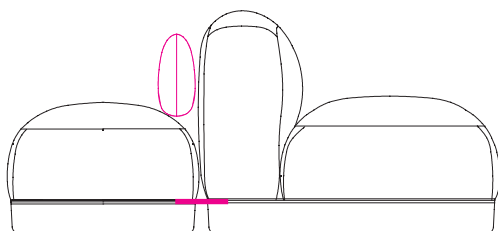

Cushions available in two different formats, with linking system, specifically made to provide greater comfort to configurations, in which the 1-seater or 2-seater bench modules are placed against the backrest of the seat modules art. 7401 and 7403.

# Ralik

## Legend

Seating modules



Container modules



Table modules



## Composition Examples

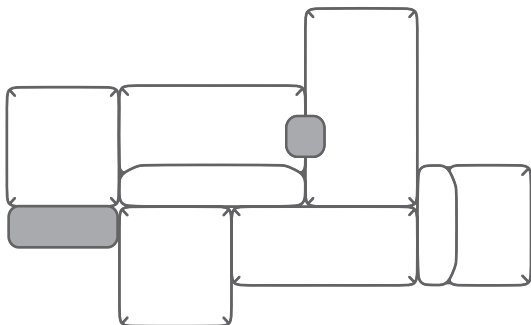

ART. 7400 + ART. 7403 + ART. 7414 + ART. 7402

+

ART. 7416 + ART. 7400 + ART. 7405 + ART. 7401

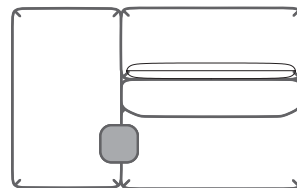

ART. 7402 + ART. 7403

+

ART. 7400 + ART. 7413

+

ART. 7416

ART. 7400  
+  
ART. 7401  
+  
ART. 7414

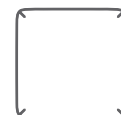
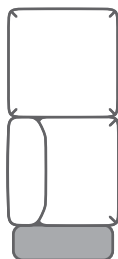

ART. 7400



# Ralik

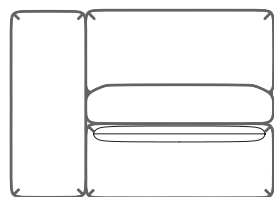

ART. 7403 + ART. 7402  
+  
ART. 7405 + ART. 7413  
+  
ART. 7417

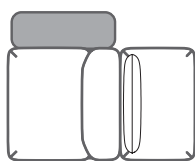





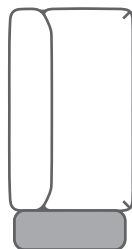



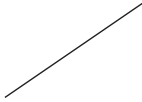
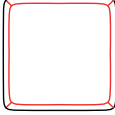
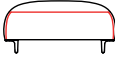
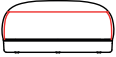
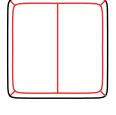
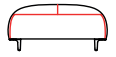

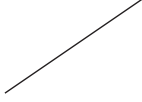
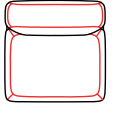
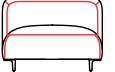

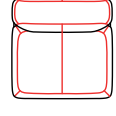
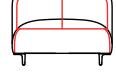

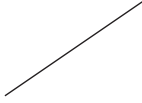
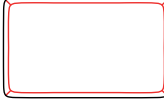
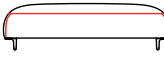

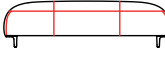
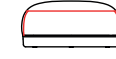
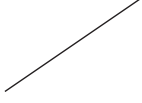
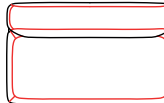
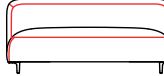
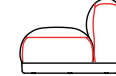
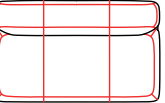
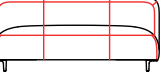
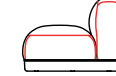
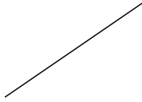
ART. 7400 + ART. 7401  
+  
ART. 7412 + ART. 7414

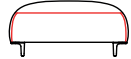
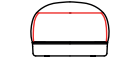
ART. 7403 + ART. 7415  
+  
ART. 7402 + ART. 7417  
+  
ART. 7404  
+  
ART. 7401  
+  
ART. 7402

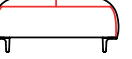

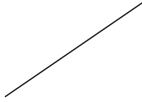
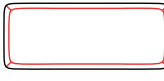
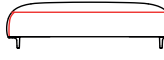
**MODULE SEWING SCHEME**

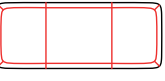
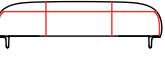
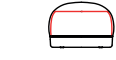
ART.	Non removable cover	Removable cover / coated fabric	soft leather
7400		  	  
7401		  	  
7402		  	  
7403		  	  
7404		  	  
7405		  	  

# Ralik

Design by Ichiro Iwasaki, 2023

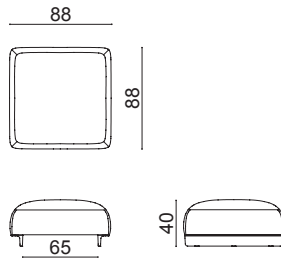

1-seater ottoman module with base in polypropylene made with recycled materials, available in 5 colours and equipped with a removable system to link seat modules. Covered with removable upholstery in fabric, leather, coated fabric or customer's own material.

Accessories:  
 USB Art. 6001  
 Replacement cover set Art. 7406  
 Fixed table module Art. 7416

SEK ART. 7400	A	B	C	D	E	F	G	H	I	J	K	L	M	ES
1-seater ottoman module	14243	14787	15331	15875	16419	16963	17507	18051	18595	19139	19683	20227	20771	22952
Base in colored polypropylene (P63, P65, P67, P68)	+ 397													
<b>SHIPMENT DETAILS</b>	<b>TECHNICAL SPECIFICATIONS</b>					<b>RESISTANCE TEST</b>								
Art.7400 1 pz = 1  - kg 25,6/ m³ 0,422	Art.7400 COL requirement m² 6.36 H 140 cm. COM Meterage m 2.046													
<b>FIRE RETARDANT TEST</b>														

Frame Base

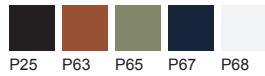

# Ralik

Design by Ichiro Iwasaki, 2023

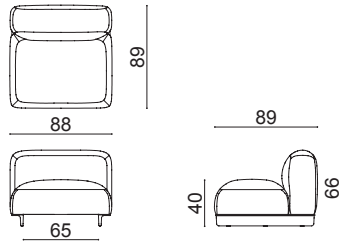

1-seater module with backrest. Base in polypropylene made with recycled materials, available in 5 colours and equipped with a removable system to link between seat modules. Covered with removable upholstery in fabric, leather, coated fabric or customer's own material.

Accessories:  
 USB Art. 6001  
 Replacement cover set Art. 7407  
 Fixed table module Art. 7416

SEK ART. 7401	A	B	C	D	E	F	G	H	I	J	K	L	M	ES
1-seater ottoman module with backrest	21546	22352	23158	23964	24770	25576	26382	27188	27994	28800	29606	30412	31218	34428
Base in colored polypropylene (P63, P65, P67, P68)	+ 397													
<b>SHIPMENT DETAILS</b>	<b>TECHNICAL SPECIFICATIONS</b>				<b>RESISTANCE TEST</b>									
Art.7401 1 pz = 1  - kg 31,5/ m³ 0,65	Art.7401 COL requirement m² 10.2 H 140 cm. COM Meterage m 3.014													
<b>FIRE RETARDANT TEST</b>														

Frame Base



# Ralik

Design by Ichiro Iwasaki,

2-seater ottoman module with base in polypropylene made with recycled materials, available in 5 colours and equipped with a removable system to link between seat modules. Covered with removable upholstery in fabric, leather, coated fabric or customer's own material.

Accessories:  
 USB Art. 6001  
 Replacement cover set Art. 7408  
 Fixed table module Art. 7416

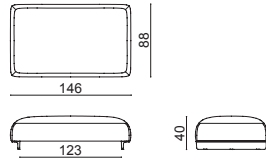

SEK ART. 7402	A	B	C	D	E	F	G	H	I	J	K	L	M	ES
2-seater ottoman module	20911	21773	22635	23497	24359	25221	26083	26945	27807	28669	29531	30393	31255	34700
Base in colored polypropylene (P63, P65, P67, P68)	+ 397													

SHIPMENT DETAILS	TECHNICAL SPECIFICATIONS	RESISTANCE TEST
<b>Art.7402</b> 1 pz = 1  - kg 38,5/ m³ 0,667	<b>Art.7402</b> COL requirement m² 9.84 H 140 cm. COM Meterage m 3.267	

FIRE RETARDANT TEST

Frame Base

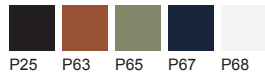

# Ralik

Design by Ichiro Iwasaki, 2023

2-seater module with backrest. Base in polypropylene made with recycled materials, available in 5 colours and equipped with a removable system to link between seat modules. Covered with removable upholstery in fabric, leather, coated fabric or customer's own material.

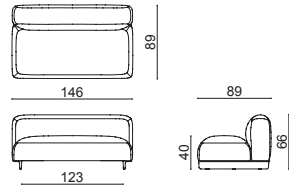

Accessories:  
 USB Art. 6001  
 Replacement cover set Art. 7409  
 Fixed table module Art. 7416

SEK ART. 7403	A	B	C	D	E	F	G	H	I	J	K	L	M	ES
2-seater ottoman module with backrest	32319	33601	34883	36165	37447	38729	40011	41293	42575	43857	45139	46421	47703	52822
Base in colored polypropylene (P63, P65, P67, P68)	+ 397													
<b>SHIPMENT DETAILS</b>	<b>TECHNICAL SPECIFICATIONS</b>				<b>RESISTANCE TEST</b>									
Art.7403 1 pz = 1  - kg 44,5/ m³ 1,078	Art.7403 COL requirement m² 15 H 140 cm. COM Meterage m 4.752													
<b>FIRE RETARDANT TEST</b>														

Frame Base



# Ralik

Design by Ichiro Iwasaki, 2023

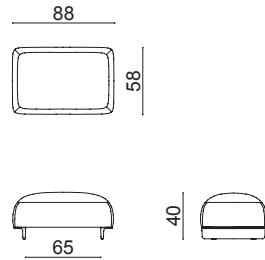

1-seater bench module with base in polypropylene made with recycled materials, available in 5 colours and equipped with a removable system to link between seat modules. Covered with removable upholstery in fabric, leather, coated fabric or customer's own material.

Accessories:  
 USB Art. 6001  
 Replacement cover set Art. 7410  
 Cushion Art. 7412  
 Fixed table module Art. 7416

SEK ART. 7404	A	B	C	E	D	F	G	H	I	J	K	L	M	ES
1-seater bench module	11113	11556	11999	12442	12885	13328	13771	14214	14657	15100	15543	15986	16429	18189
Base in colored polypropylene (P63, P65, P67, P68)	+ 397													
<b>SHIPMENT DETAILS</b>	<b>TECHNICAL SPECIFICATIONS</b>					<b>RESISTANCE TEST</b>								
Art.7404 1 pz = 1  - kg 17/ m³ 0,274	Art.7404 COL requirement m² 4.8 H 140 cm. COM Meterage m 1.694													
<b>FIRE RETARDANT TEST</b>														

Frame Base



# Ralik

Design by Ichiro Iwasaki, 2023

2-seater bench module with base in polypropylene made with recycled materials, available in 5 colours and equipped with a removable linking system between seat modules. Covered with removable upholstery in fabric, leather, coated fabric or customer's own material.

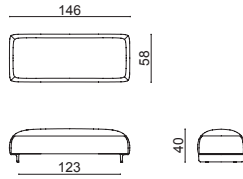

Accessories:  
 USB Art. 6001  
 Replacement cover set Art. 7411  
 Cushion Art. 7413  
 Fixed table module Art. 7416

SEK ART. 7405	A	B	C	D	E	F	G	H	I	J	K	L	M	ES
2-seater bench module	15604	16239	16874	17509	18144	18779	19414	20049	20684	21319	21954	22589	23224	25764
Base in colored polypropylene (P63, P65, P67, P68)	+ 397													

SHIPMENT DETAILS	TECHNICAL SPECIFICATIONS	RESISTANCE TEST
<b>Art.7405</b> 1 pz = 1  - kg 26/ m² 0,448	<b>Art.7405</b> COL requirement m² 6.72 H 140 cm. COM Meterage m 2.31	

FIRE RETARDANT TEST

Frame Base





# Ralik

Design by Ichiro Iwasaki, 2023

Storage modules available in two formats, with structure in curved and powder-coated sheet metal and shelves in plywood with reconstituted oak finish. The structure and top finishes can be freely combined. It can be electrified with the Pix accessory by Bachmann in USB version.



<b>ART. 7414</b>  	<b>ART. 7415</b>  
--------------------------	--------------------------

	<b>Top</b>	
<b>SEK ART.7414</b>	Container module L. 55,5 cm	7111
<b>SEK ART.7415</b>	Container module L. 85,5 cm	9606
	Grommet + electrification	+ 2381

SHIPMENT DETAILS	TECHNICAL SPECIFICATIONS	RESISTANCE TEST
<b>Art. 7414</b> 1 pz = 1  - kg 7,8/ m³ 0,088 1 pz = 2  - kg 8,5/ m³ 0,093 <b>Art. 7415</b> 1 pz = 1  - kg 12,5/ m³ 0,131 1 pz = 2  - kg 13,2/ m³ 0,135		
<b>FIRE RETARDANT TEST</b>		

Frame Base



Top

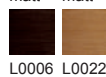

Single cable unit (1 USB + 1 connector)



# Ralik

Design by Ichiro Iwasaki, 2023

Side table with central base and column in powder-coated metal, equipped with gas mechanism for height adjustment. Rectangular top in plywood and finish in reconstituted oak (1,2 cm thick). The base and top finishes can be freely combined.

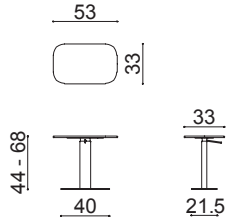

	Top	
<b>SEK ART. 7417</b>	H. adj. freestanding table	8845

SHIPMENT DETAILS	TECHNICAL SPECIFICATIONS	RESISTANCE TEST
<b>Art. 7417</b> 1 pz = 1  - kg 10/ m³ 0,12 		
<b>FIRE RETARDANT TEST</b>		

Frame Base



Top

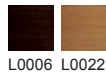

# Ralik

Design by Ichiro Iwasaki, 2023

Fixed table module, can be positioned on the right or left side or between ottoman, bench or seat with backrest modules. Support in powder-coated metal, square top in plywood and finish in reconstituted oak (1,2 cm thick). The support and top finishes can be freely combined.

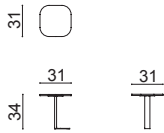

	Top	
<b>SEK ART. 7416</b>	Fixed table module	3119

SHIPMENT DETAILS	TECHNICAL SPECIFICATIONS	RESISTANCE TEST
<b>Art. 7416</b> 1 pz = 2  - kg 3,6/ m² 0,045 		
<b>FIRE RETARDANT TEST</b>		

Frame Base



Top

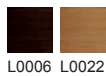

# Ralik

Design by Ichiro Iwasaki, 2023

Cushions available in two different formats, with linking system, specifically made to provide greater comfort to configurations, in which the 1-seater or 2-seater bench modules are placed against the backrest of the seat modules art. 7401 and 7403. Upholstery in fabric, leather, coated fabric or customer's own material.

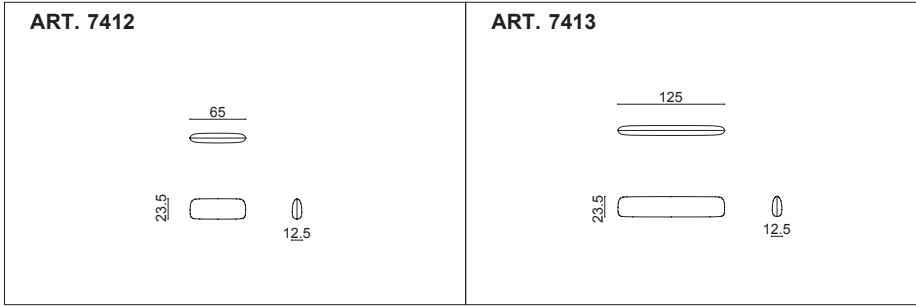

<b>SEK ART. 7412</b>	A	B	C	D	E	F	G	H	I	J	K	L	M	ES
Cushion for 1-seater bench	2019	2258	2497	2736	2975	3214	3453	3692	3931	4170	4409	4648	4887	5829
<b>SEK ART. 7413</b>	A	B	C	D	E	F	G	H	I	J	K	L	M	ES
Cushion for 2-seater bench	2767	3175	3583	3991	4399	4807	5215	5623	6031	6439	6847	7255	7663	9299



SHIPMENT DETAILS	TECHNICAL SPECIFICATIONS	RESISTANCE TEST
<p><b>Art. 7412</b> 1 pz = 1  - kg 1,35/ m³ 0,051</p> <p><b>Art. 7413</b> 1 pz = 1  - kg 2,5/ m³ 0,075</p>	<p><b>Art.7412</b> COL requirement m² 1.68 H 140 cm. COM Meterage m 0.88</p> <p><b>Art.7413</b> COL requirement m² 3.36 H 140 cm. COM Meterage m 1.54</p>	
<b>FIRE RETARDANT TEST</b>		



# Accessories

Design by Ichiro Iwasaki, 2023

<b>SEK ART. 7406</b>	A	B	C	D	E	F	G	H	I	J	K	L	M	ES
Cover art. 7400	3845	4389	4933	5477	6021	6565	7109	7653	8197	8741	9285	9829	10373	12554
<b>SEK ART. 7407</b>	A	B	C	D	E	F	G	H	I	J	K	L	M	ES
Cover art. 7401	5851	6657	7463	8269	9075	9881	10687	11493	12299	13105	13911	14717	15523	18734
<b>SEK ART. 7408</b>	A	B	C	D	E	F	G	H	I	J	K	L	M	ES
Cover art. 7402	4717	5579	6441	7303	8165	9027	9889	10751	11613	12475	13337	14199	15061	18507



SHIPMENT DETAILS	TECHNICAL SPECIFICATIONS	RESISTANCE TEST
<b>Art. 7406</b> 1 pz = 1  - kg 2,05/ m³ 0,05 <b>Art. 7407</b> 1 pz = 1  - kg 2,3/ m³ 0,05 <b>Art. 7408</b> 1 pz = 1  - kg 2,15/ m³ 0,05	<b>Art.7406</b> COL requirement m² 6.36 H 140 cm. COM Meterage m 2.046 <b>Art.7407</b> COL requirement m² 10.2 H 140 cm. COM Meterage m 3.014 <b>Art.7408</b> COL requirement m² 9.84 H 140 cm. COM Meterage m 3.267	
<b>FIRE RETARDANT TEST</b>		



# Accessories

Design by Ichiro Iwasaki, 2023

<b>SEK ART. 7409</b>	A	B	C	D	E	F	G	H	I	J	K	L	M	ES
Cover art. 7403	7610	8892	10174	11456	12738	14020	15302	16584	17866	19148	20430	21712	22994	28112
<b>SEK ART. 7410</b>	A	B	C	D	E	F	G	H	I	J	K	L	M	ES
Cover art. 7404	3573	4016	4459	4902	5345	5788	6231	6674	7117	7560	8003	8446	8889	10649
<b>SEK ART. 7411</b>	A	B	C	D	E	F	G	H	I	J	K	L	M	ES
Cover art. 7405	3856	4491	5126	5761	6396	7031	7666	8301	8936	9571	10206	10841	11476	14016

SHIPMENT DETAILS	TECHNICAL SPECIFICATIONS	RESISTANCE TEST
<b>Art. 7409</b> 1 pz = 1  - kg 2,8/ m³ 0,05 <b>Art. 7410</b> 1 pz = 1  - kg 1,8/ m³ 0,05 <b>Art. 7411</b> 1 pz = 1  - kg 2/ m³ 0,05	<b>Art.7409</b> COL requirement m² 15 H 140 cm. COM Meterage m 4.752 <b>Art.7410</b> COL requirement m² 4.8 H 140 cm. COM Meterage m 1.694 <b>Art.7411</b> COL requirement m² 6.72 H 140 cm. COM Meterage m 2.31	
<b>FIRE RETARDANT TEST</b>		



## Accessories

### **SEK ART. 6001**



Power supply kit consisting of 2 units with 2 USB A sockets each, 1 power supply unit and cable clamps. Electric cable not included.

1655

SHIPMENT DETAILS	TECHNICAL SPECIFICATIONS	RESISTANCE TEST
<b>FIRE RETARDANT TEST</b>		



# SAARI SOFA

---

Design by  
Lievore Altherr Molina  
2009





# Saari Chair

## Collection overview

Available in the Chairs and Stools section

### Type



4 legs armchair

Options:  
Castors

4 legs armchair

Options:  
Castors



Armchair with aluminium  
swivel trestle base

Armchair with aluminium  
swivel trestle base

Armchair with aluminium  
fixed trestle base mounted  
on self-braking castors

Armchair with aluminium  
fixed trestle base mounted  
on self-braking castors

### Options



— Castors

# Saari Sofa

## Collection overview

Available in the Sofas and Benches section

### Type



Armchair — 71 cm



Armchair — 82,5 cm



Armchair XL — 90 cm



Sofa — 2 seats



Sofa — 3 seats



Bench — 2 seats

### Legs finishes



Veneered steel



Chromed / Powdercoated

### Options



USB

— MODULE SEWING SCHEME

— MODULE ZIPPER SCHEME

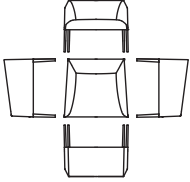
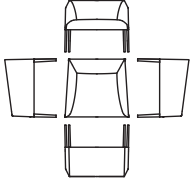
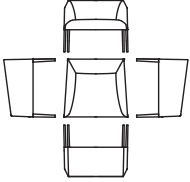
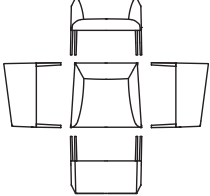
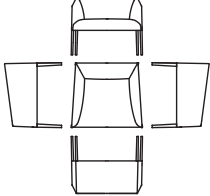
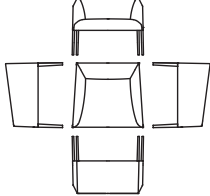
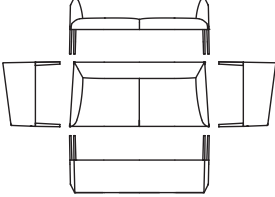
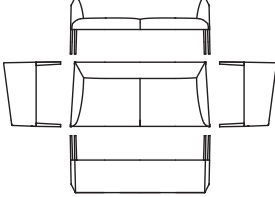
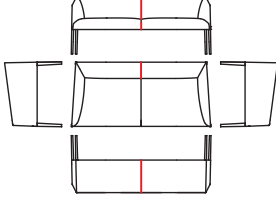
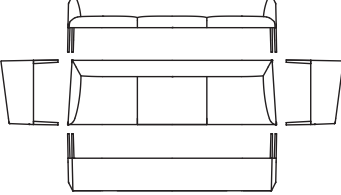
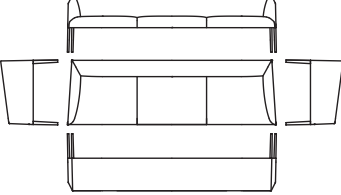
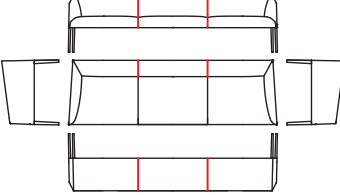
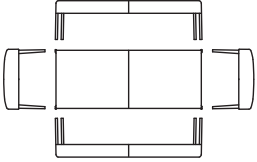
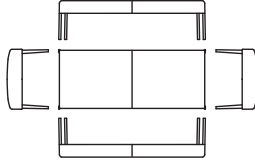
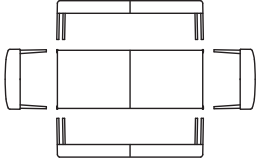
ART.	Non removable cover	Removable cover / coated fabric	soft leather
2710			
2711			
2712			
2713			
2714			

# Saari S

Design by Lievore Altherr Molina, 2009

Armchair (71 cm wide seat) with polished or powder-coated four-leg steel base, or with oak effect reconstituted veneer base. Upholstered shell with metal and plywood frame available in leather, coated fabric, fabric or customer's material. Fully removable cover version available upon request without surcharge.

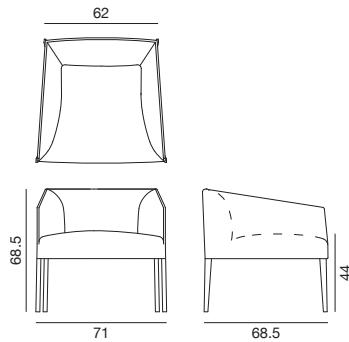

Accessories:  
Replacement cover set Art. 2715  
USB Art. 6001

<b>SEK ART. 2710</b>	<b>A</b>	<b>B COM</b>	<b>C COL</b>	<b>D</b>	<b>E</b>	<b>F</b>	<b>G</b>	<b>H</b>	<b>I</b>	<b>J</b>	<b>K</b>	<b>L</b>	<b>M</b>	<b>ES</b>
VENEERED LEGS	16717	17371	18025	18679	19333	19987	20641	21295	21949	22603	23257	23911	24565	27505
POLISHED	15027	15681	16335	16989	17643	18297	18951	19605	20259	20913	21567	22221	22875	25838
POWDERCOATED	15027	15681	16335	16989	17643	18297	18951	19605	20259	20913	21567	22221	22875	25838
Fire retardant foam	+ 2227 <b>Art. 2710</b>													

<b>SHIPMENT DETAILS</b>	<b>TECHNICAL SPECIFICATIONS</b>	<b>RESISTANCE TEST</b>
<b>Art. 2710</b> 1 pz = 1  - kg 15/ m <sup>2</sup> 0,671	<b>Art.2710</b> COL requirement m <sup>2</sup> 4.51 H 140 cm. COM Meterage m 2.75	
<b>FIRE RETARDANT TEST</b> Classe 1IM Omologazione Italia Field Kvadrat.		

Frame Base

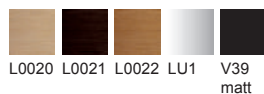

# Saari M

Design by Lievore Altherr Molina, 2009

Armchair (82.5 cm wide seat) with polished or powder-coated four-leg steel base, or with oak effect reconstituted veneer four-leg base. Upholstered shell with metal and plywood frame available in leather, coated fabric, fabric or customer's material. Fully removable cover version available upon request without surcharge.

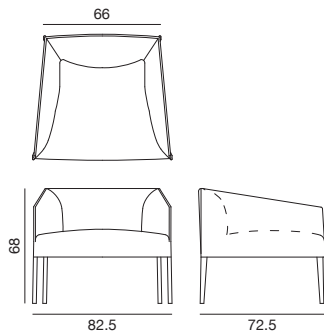

Accessories:  
Replacement cover set Art. 2716  
USB Art. 6001

<b>SEK ART. 2711</b>	<b>A</b>	<b>B COM</b>	<b>C COL</b>	<b>D</b>	<b>E</b>	<b>F</b>	<b>G</b>	<b>H</b>	<b>I</b>	<b>J</b>	<b>K</b>	<b>L</b>	<b>M</b>	<b>ES</b>
veneered legs	18729	19563	20397	21231	22065	22899	23733	24567	25401	26235	27069	27903	28737	32125
polished	17039	17873	18707	19541	20375	21209	22043	22877	23711	24545	25379	26213	27047	30423
powdercoated	17039	17873	18707	19541	20375	21209	22043	22877	23711	24545	25379	26213	27047	30423
Fire retardant foam	+ 2358	<b>Art. 2711</b>												

<b>SHIPMENT DETAILS</b>	<b>TECHNICAL SPECIFICATIONS</b>	<b>RESISTANCE TEST</b>
<b>Art. 2711</b> 1 pz = 1  - kg 19/ m <sup>2</sup> 0,671	<b>Art.2711</b> COL requirement m <sup>2</sup> 5.29 H 140 cm. COM Meterage m 3.14	
<b>FIRE RETARDANT TEST</b> Classe 1IM Omologazione Italia Field Kvadrat.		

Frame Base

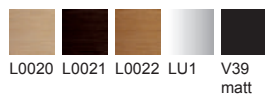

# Saari XL

Design by Lievore Altherr Molina, 2014



Armchair (90 cm wide seat) with polished or powder-coated four-leg steel base, or with oak effect reconstituted veneer four-leg base. Metal and plywood frame shell upholstered in leather, coated fabric, fabric or customer's own material. The version with removable cover is available upon request without surcharge.

Accessories:  
Replacement cover set Art. 2723  
USB Art. 6001

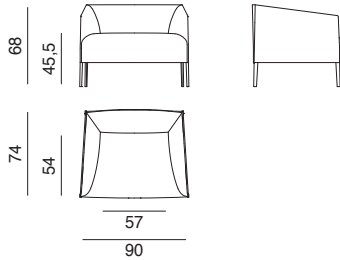

SEK ART. 2722	A	B COM	C COL	D	E	F	G	H	I	J	K	L	M	ES
		22636	23660	24684	25708	26732	27756	28780	29804	30828	31852	32876	33900	34924
POLISHED	20968	21992	23016	24040	25064	26088	27112	28136	29160	30184	31208	32232	33256	37697
POWDERCOATED	20968	21992	23016	24040	25064	26088	27112	28136	29160	30184	31208	32232	33256	37697
Fire retardant foam	+ 2905													

SHIPMENT DETAILS	TECHNICAL SPECIFICATIONS	RESISTANCE TEST
<b>Art. 2722</b> 1 pz = 1  - kg 37/ m³ 0,843	<b>Art. 2722</b> COL requirement m² 7.56 H 140 cm. COM Meterage m 3.69	
<b>FIRE RETARDANT TEST</b> Classe 1IM Omologazione Italia Steelcut Trio 3 Kvadrat. Coated fabric Valencia Spradling.		

Frame Base

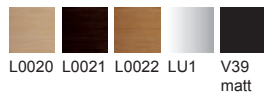

# Saari

Design by Lievore Altherr Molina, 2009



Two seater sofa with polished or powder-coated four-leg steel base, or with oak effect reconstituted veneer four-leg base. Shell with metal and plywood frame, upholstery available in leather, coated fabric, fabric or customer's material. Fully removable cover version available upon request without surcharge.

Accessories:  
Replacement cover set Art. 2717  
USB Art. 6001

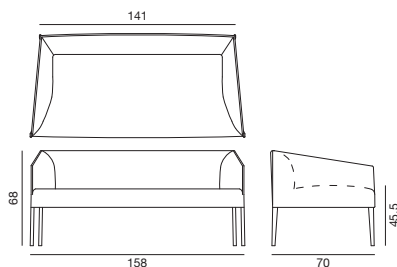

SEK ART. 2712	A	B COM	C COL	D	E	F	G	H	I	J	K	L	M	ES
	29112	30541	31970	33399	34828	36257	37686	39115	40544	41973	43402	44831	46260	52284
POLISHED	27446	28875	30304	31733	33162	34591	36020	37449	38878	40307	41736	43165	44594	50604
POWDERCOATED	27446	28875	30304	31733	33162	34591	36020	37449	38878	40307	41736	43165	44594	50604
Fire retardant foam	+ 4191 Art. 2712													

SHIPMENT DETAILS	TECHNICAL SPECIFICATIONS	RESISTANCE TEST
<b>Art. 2712</b> 1 pz = 1  - kg 32/ m² 0,634	<b>Art.2712</b> COL requirement m² 10.5 H 140 cm. COM Meterage m 4.46	
<b>FIRE RETARDANT TEST</b> Classe 1IM Omologazione Italia Field Kvadrat. Steelcut Trio 3 Kvadrat. Coated fabric Valencia Spradling.		

Frame Base

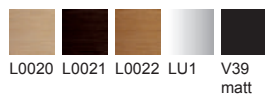

# Saari

Design by Lievore Altherr Molina, 2009



Three seater sofa with polished or powder-coated four-leg steel base, or with oak effect reconstituted veneer four-leg base. Shell with metal and plywood frame, upholstery available in leather, coated fabric, fabric or customer's material. Fully removable cover version available upon request without surcharge.

Accessories:  
Replacement cover set Art. 2718  
USB Art. 6001

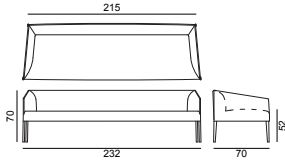

SEK ART. 2713	A	B COM	C COL	D	E	F	G	H	I	J	K	L	M	ES
	35138	36936	38734	40532	42330	44128	45926	47724	49522	51320	53118	54916	56714	64000
POLISHED	33470	35268	37066	38864	40662	42460	44258	46056	47854	49652	51450	53248	55046	62321
POWDERCOATED	33470	35268	37066	38864	40662	42460	44258	46056	47854	49652	51450	53248	55046	62321
Fire retardant foam	+ 5990 Art. 2713													

SHIPMENT DETAILS	TECHNICAL SPECIFICATIONS	RESISTANCE TEST
<b>Art. 2713</b> 1 pz = 1  - kg 49/ m³ 1,524	<b>Art.2713</b> COL requirement m² 15.12 H 140 cm. COM Meterage m 6.05	<ul style="list-style-type: none"> <li>• EN 1728:2012 - EN 16139:2013 6.10</li> <li>• EN 1728:2012 - EN 16139:2013 6.15</li> <li>• EN 1728:2012 - EN 16139:2013 6.17</li> <li>• EN 1728:2012 - EN 16139:2013 6.20</li> <li>• EN 1728:2012 - EN 16139:2013 6.25</li> <li>• EN 1728:2012 - EN 16139:2013 6.4</li> <li>• EN 1728:2012 - EN 16139:2013 6.6</li> </ul> <ul style="list-style-type: none"> <li>• EN 1728:2012 - EN 16139:2013 6.11</li> <li>• EN 1728:2012 - EN 16139:2013 6.16</li> <li>• EN 1728:2012 - EN 16139:2013 6.18</li> <li>• EN 1728:2012 - EN 16139:2013 6.24</li> <li>• EN 1728:2012 - EN 16139:2013 6.26</li> <li>• EN 1728:2012 - EN 16139:2013 6.5</li> <li>• EN 1728:2012 - EN 16139:2013 6.27.1</li> </ul>
<b>FIRE RETARDANT TEST</b> Classe 1IM Omologazione Italia Field Kvadrat. Steelcut Trio 3 Kvadrat. Coated fabric Valencia Spradling.		

Frame Base

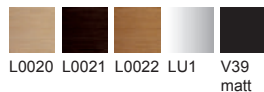



# Saari

Design by Lievore Altherr Molina, 2009



Two seater bench with polished or powder-coated four-leg steel base, or with oak effect reconstituted veneer four-leg base. Upholstered seat with metal and plywood frame available in leather, coated fabric, fabric or customer's material. Fully removable cover version available upon request without surcharge.

Accessories:  
Replacement cover set Art. 2719  
USB Art. 6001

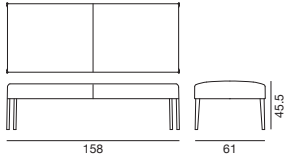

SEK ART. 2714	A	B COM	C COL	D	E	F	G	H	I	J	K	L	M	ES
VENEERED LEGS	16098	16693	17288	17883	18478	19073	19668	20263	20858	21453	22048	22643	23238	25624
POLISHED	14419	15014	15609	16204	16799	17394	17989	18584	19179	19774	20369	20964	21559	23945
POWDERCOATED	14419	15014	15609	16204	16799	17394	17989	18584	19179	19774	20369	20964	21559	23945
Fire retardant foam	+ 822 Art. 2714													

SHIPMENT DETAILS	TECHNICAL SPECIFICATIONS	RESISTANCE TEST
<b>Art. 2714</b> 1 pz = 1  - kg 27 / m <sup>2</sup> 0,645	<b>Art.2714</b> COL requirement m <sup>2</sup> 3.72 H 140 cm. COM Meterage m 2.15	
<b>FIRE RETARDANT TEST</b> Classe 1IM Omologazione Italia Field Kvadrat. Steelcut Trio 3 Kvadrat. Coated fabric Valencia Spradling.		



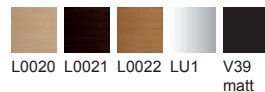



Frame Base



# Accessories

Design by Lievore Altherr Molina, 2009

<b>SEK ART. 2715</b>	A	B COM	C COL	D	E	F	G	H	I	J	K	L	M	ES
SPARE COVER art. 2710	4858	5692	6526	7360	8194	9028	9862	10696	11530	12364	13198	14032	14866	18241
<b>SEK ART. 2716</b>	A	B COM	C COL	D	E	F	G	H	I	J	K	L	M	ES
SPARE COVER art. 2711	5810	6798	7786	8774	9762	10750	11738	12726	13714	14702	15690	16678	17666	21790
<b>SEK ART. 2717</b>	A	B COM	C COL	D	E	F	G	H	I	J	K	L	M	ES
SPARE COVER art. 2712	10549	12252	13955	15658	17361	19064	20767	22470	24173	25876	27579	29282	30985	38102
<b>SEK ART. 2718</b>	A	B COM	C COL	D	E	F	G	H	I	J	K	L	M	ES
SPARE COVER art. 2713	13586	15444	17302	19160	21018	22876	24734	26592	28450	30308	32166	34024	35882	43460
<b>SEK ART. 2719</b>	A	B COM	C COL	D	E	F	G	H	I	J	K	L	M	ES
SPARE COVER art. 2714	4346	5048	5750	6452	7154	7856	8558	9260	9962	10664	11366	12068	12770	15968
<b>SEK ART. 2723</b>	A	B COM	C COL	D	E	F	G	H	I	J	K	L	M	ES
SPARE COVER art. 2722	6132	7310	8488	9666	10844	12022	13200	14378	15556	16734	17912	19090	20268	25445

SHIPMENT DETAILS	TECHNICAL SPECIFICATIONS	RESISTANCE TEST
<p><b>Art. 2715</b> 1 pz = 1  - kg 5/ m³ 0,039</p> <p><b>Art. 2716</b> 1 pz = 1  - kg 5/ m³ 0,039</p> <p><b>Art. 2717</b> 1 pz = 1  - kg 5/ m³ 0,23</p> <p><b>Art. 2718</b> 1 pz = 1  - kg 5/ m³ 0,23</p> <p><b>Art. 2719</b> 1 pz = 1  - kg 5/ m³ 0,23</p> <p><b>Art. 2723</b> 1 pz = 1  - kg 5/ m³ 0,039</p>	<p><b>Art.2715</b> COL requirement m² 4.51 H 140 cm. COM Meterage m 2.75</p> <p><b>Art.2716</b> COL requirement m² 5.29 H 140 cm. COM Meterage m 3.14</p> <p><b>Art.2717</b> COL requirement m² 12.6 H 140 cm. COM Meterage m 4.46</p> <p><b>Art.2718</b> COL requirement m² 15.12 H 140 cm. COM Meterage m 6.05</p> <p><b>Art.2719</b> COL requirement m² 3.72 H 140 cm. COM Meterage m 2.15</p> <p><b>Art.2723</b> COL requirement m² 7.56 H 140 cm. COM Meterage m 3.69</p>	
<b>FIRE RETARDANT TEST</b>		



## Accessories

### **SEK ART. 6001**



Power supply kit consisting of 2 units with 2 USB A sockets each, 1 power supply unit and cable clamps. Electric cable not included.

1655

SHIPMENT DETAILS	TECHNICAL SPECIFICATIONS	RESISTANCE TEST
<b>FIRE RETARDANT TEST</b>		



# SEAN

---

Design by Jean-Marie Massaud

2009



# Sean

## Collection overview

---

### Type



Armchair



Sofa — 2 seats



Sofa — 3 seats



Bench — 2 seats

### Options



USB  
— only on powder coated bases

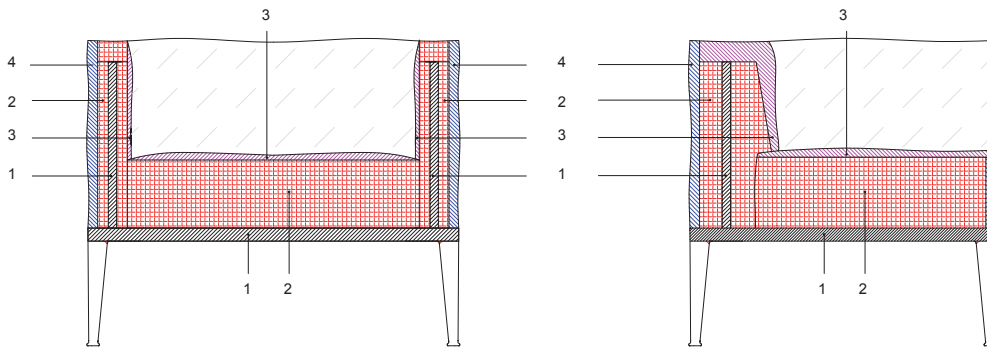

## DESCRIPTION

1. WOODEN FRAME
2. MULTI-DENSITY POLYURETHANE
3. DACRON FIBER PADDING
4. RESIN FIBER PADDING

# Sean

Design by Jean-Marie Massaud, 2009

Armchair with MDF frame and aluminium legs, upholstered in fabric, leather, coated fabric or customer's material. Fully removable cover version available upon request with a surcharge.

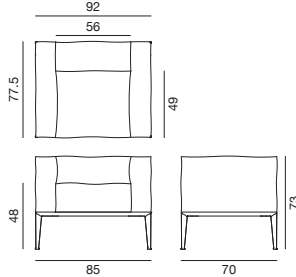

Accessories:  
Replacement cover set Art. 1405  
USB Art. 6001

SEK ART. 1400	A	B COM	C COL	D	E	F	G	H	I	J	K	L	M	ES
POWDERCOATED	18170	18956	19742	20528	21314	22100	22886	23672	24458	25244	26030	26816	27602	30672
Removable version	+ 3798	Art. 1400												
Polished aluminium	+ 1310	Art. 1400												
Fire retardant foam	+ 881	Art. 1400												

SHIPMENT DETAILS	TECHNICAL SPECIFICATIONS	RESISTANCE TEST
<b>Art. 1400</b> 1 pz = 1  - kg 43/ m³ 0,406	<b>Art.1400</b> COL requirement m² 7.25 H 140 cm. COM Meterage m 4.07	<ul style="list-style-type: none"> <li>• EN 1728:2012 - EN 16139:2013 6.10</li> <li>• EN 1728:2012 - EN 16139:2013 6.15</li> <li>• EN 1728:2012 - EN 16139:2013 6.17</li> <li>• EN 1728:2012 - EN 16139:2013 6.20</li> <li>• EN 1728:2012 - EN 16139:2013 6.25</li> <li>• EN 1728:2012 - EN 16139:2013 6.4</li> </ul> <ul style="list-style-type: none"> <li>• EN 1728:2012 - EN 16139:2013 6.11</li> <li>• EN 1728:2012 - EN 16139:2013 6.16</li> <li>• EN 1728:2012 - EN 16139:2013 6.18</li> <li>• EN 1728:2012 - EN 16139:2013 6.24</li> <li>• EN 1728:2012 - EN 16139:2013 6.26</li> <li>• EN 1728:2012 - EN 16139:2013 6.5</li> </ul>
<b>FIRE RETARDANT TEST</b> Classe 1IM Omologazione Italia Hallingdal 65 Kvadrat. Remix 3 Kvadrat. Coated fabric Valencia Spradling.		

Frame Base

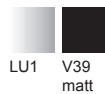

# Sean

Design by Jean-Marie Massaud, 2009

Two-seat sofa with MDF frame and aluminium feet, upholstered in fabric, leather, coated fabric or customer's material. Fully removable cover version available upon request with a surcharge.

Accessories:  
Replacement cover set Art. 1406  
USB Art. 6001

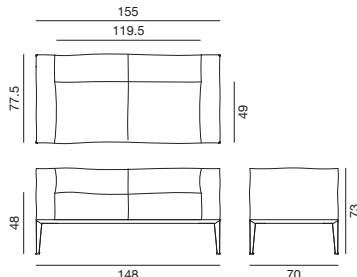

<b>SEK ART. 1401</b>	A	B COM	C COL	D	E	F	G	H	I	J	K	L	M	ES
POWDERCOATED	26088	27207	28326	29445	30564	31683	32802	33921	35040	36159	37278	38397	39516	44247
Removable version	+ 5775	<b>Art. 1401</b>												
Polished aluminium	+ 1822	<b>Art. 1401</b>												
Fire retardant foam	+ 1322	<b>Art. 1401</b>												

SHIPMENT DETAILS	TECHNICAL SPECIFICATIONS	RESISTANCE TEST
<b>Art. 1401</b> 1 pz = 1  - kg 65/ m³ 0,769	<b>Art.1401</b> COL requirement m² 11.56 H 140 cm. COM Meterage m 5.72	<ul style="list-style-type: none"> <li>• EN 1728:2012 - EN 16139:2013 6.10</li> <li>• EN 1728:2012 - EN 16139:2013 6.15</li> <li>• EN 1728:2012 - EN 16139:2013 6.17</li> <li>• EN 1728:2012 - EN 16139:2013 6.20</li> <li>• EN 1728:2012 - EN 16139:2013 6.25</li> <li>• EN 1728:2012 - EN 16139:2013 6.4</li> </ul> <ul style="list-style-type: none"> <li>• EN 1728:2012 - EN 16139:2013 6.11</li> <li>• EN 1728:2012 - EN 16139:2013 6.16</li> <li>• EN 1728:2012 - EN 16139:2013 6.18</li> <li>• EN 1728:2012 - EN 16139:2013 6.24</li> <li>• EN 1728:2012 - EN 16139:2013 6.26</li> <li>• EN 1728:2012 - EN 16139:2013 6.5</li> </ul>
<b>FIRE RETARDANT TEST</b> Classe 1IM Omologazione Italia Hallingdal 65 Kvadrat. Remix 3 Kvadrat. Coated fabric Valencia Spradling.		

Frame Base

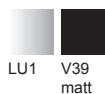



# Sean



Design by Jean-Marie Massaud, 2009

Three-seat sofa with MDF frame and aluminium legs, upholstered in fabric, leather, coated fabric or customer's material. Fully removable cover version available upon request with a surcharge.

Accessories:  
Replacement cover set Art. 1407  
USB Art. 6001

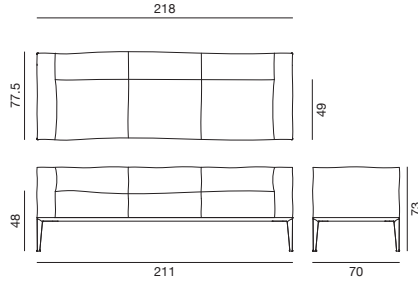

SEK ART. 1402	A	B COM	C COL	D	E	F	G	H	I	J	K	L	M	ES
POWDERCOATED	34852	36400	37948	39496	41044	42592	44140	45688	47236	48784	50332	51880	53428	59869
Removable version	+ 7775	Art. 1402												
Polished aluminium	+ 2251	Art. 1402												
Fire retardant foam	+ 1715	Art. 1402												

SHIPMENT DETAILS	TECHNICAL SPECIFICATIONS	RESISTANCE TEST
<b>Art. 1402</b> 1 pz = 1  - kg 89/ m³ 1,044	<b>Art.1402</b> COL requirement m² 15,88 H 140 cm. COM Meterage m 7.37	
<b>FIRE RETARDANT TEST</b> Classe 1IM Omologazione Italia Hallingdal 65 Kvadrat. Remix 3 Kvadrat. Coated fabric Valencia Spradling.		

Frame Base

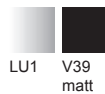

# Sean



Design by Jean-Marie Massaud, 2009

Two-seat bench with MDF frame and aluminium legs, upholstered in fabric, leather, coated fabric or customer's material. Fully removable cover version available upon request with a surcharge.

Accessories:  
Replacement cover set Art. 1408  
USB Art. 6001

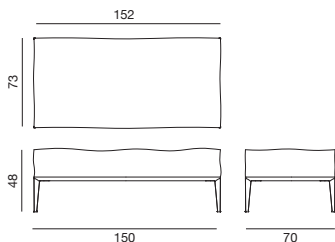

<b>SEK ART. 1403</b>	A	B COM	C COL	D	E	F	G	H	I	J	K	L	M	ES
POWDERCOATED	12336	12812	13288	13764	14240	14716	15192	15668	16144	16620	17096	17572	18048	19909
Removable version	+ 2976	<b>Art. 1403</b>												
Polished aluminium	+ 1822	<b>Art. 1403</b>												
Fire retardant foam	+ 381	<b>Art. 1403</b>												

SHIPMENT DETAILS	TECHNICAL SPECIFICATIONS	RESISTANCE TEST
<b>Art. 1403</b> 1 pz = 1  - kg 26/ m² 0,692	<b>Art.1403</b> COL requirement m² 3.72 H 140 cm. COM Meterage m 2.53	
<b>FIRE RETARDANT TEST</b> Classe 1IM Omologazione Italia Hallingdal 65 Kvadrat. Remix 3 Kvadrat. Coated fabric Valencia Spradling.		



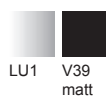

Frame Base



# Accessories

Design by Jean-Marie Massaud, 2009

<b>SEK ART. 1405</b>	A	B COM	C COL	D	E	F	G	H	I	J	K	L	M	ES
SPARE COVER art. 1400	8347	9883	11419	12955	14491	16027	17563	19099	20635	22171	23707	25243	26779	29768
<b>SEK ART. 1406</b>	A	B COM	C COL	D	E	F	G	H	I	J	K	L	M	ES
SPARE COVER art. 1401	14312	16253	18194	20135	22076	24017	25958	27899	29840	31781	33722	35663	37604	42091
<b>SEK ART. 1407</b>	A	B COM	C COL	D	E	F	G	H	I	J	K	L	M	ES
SPARE COVER art. 1402	18516	21350	24184	27018	29852	32686	35520	38354	41188	44022	46856	49690	52524	56344
<b>SEK ART. 1408</b>	A	B COM	C COL	D	E	F	G	H	I	J	K	L	M	ES
SPARE COVER art. 1403	2965	3799	4633	5467	6301	7135	7969	8803	9637	10471	11305	12139	12973	14741

SHIPMENT DETAILS	TECHNICAL SPECIFICATIONS	RESISTANCE TEST
<p><b>Art. 1405</b> 1 pz = 1  - kg 5/ m³ 0,23</p> <p><b>Art. 1406</b> 1 pz = 1  - kg 5/ m³ 0,23</p> <p><b>Art. 1407</b> 1 pz = 1  - kg 5/ m³ 0,23</p> <p><b>Art. 1408</b> 1 pz = 1  - kg 5/ m³ 0,23</p>	<p><b>Art.1405</b> COL requirement m² 7.25 H 140 cm. COM Meterage m 4.07</p> <p><b>Art.1406</b> COL requirement m² 11.56 H 140 cm. COM Meterage m 5.72</p> <p><b>Art.1407</b> COL requirement m² 15.88 H 140 cm. COM Meterage m 7.37</p> <p><b>Art.1408</b> COL requirement m² 3.72 H 140 cm. COM Meterage m 2.53</p>	
<b>FIRE RETARDANT TEST</b>		



## Accessories

### **SEK ART. 6001**



Power supply kit consisting of 2 units with 2 USB A sockets each, 1 power supply unit and cable clamps. Electric cable not included.

1655

SHIPMENT DETAILS	TECHNICAL SPECIFICATIONS	RESISTANCE TEST
<b>FIRE RETARDANT TEST</b>		





# SHAAL

---

Design by Doshi-Levien

2022 — Product Update 2023



# Shaal

## Collection overview

---

### Upholstery Types



(A) — Monomaterial

The outer panel and the cushions are upholstered with the same material



(B) — Bimaterial

The outer panel and the cushions are upholstered with different materials in specially designed combinations

### Base

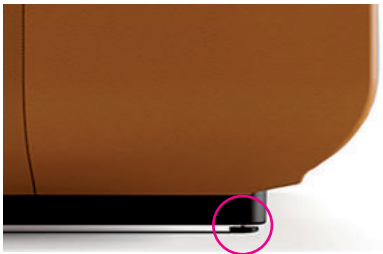

Base in polypropilene made with recycled materials, equipped with height-adjustable glides.

### Options



— Cushions



USB

# Shaal

---

## Free-standing

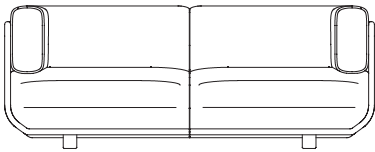

2-seater sofa configuration

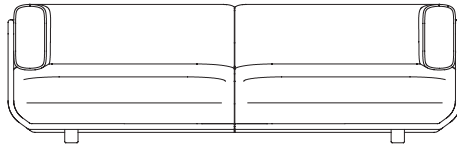

3-seater sofa configuration



Daybed



Ottoman



---

**Modular system**

**1,5 seater**

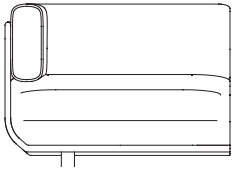

Left end module

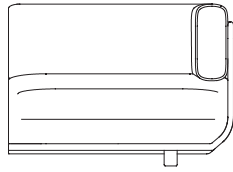

Right end module

---

**1 seater**

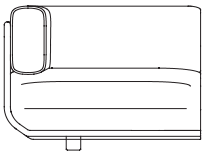

Left end module

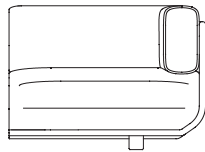

Right end module

---

**90° corner module**

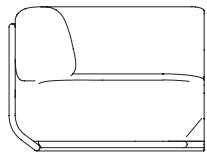

**Central module**

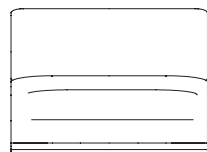

---

**Chaise-longue module**

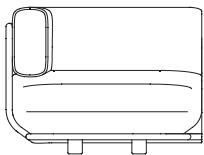

Left end module

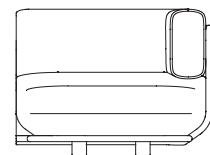

Right end module

# Shaal

## Examples of possible layouts

ART. 6900 + ART. 6904 + ART. 6905 +  
ART. 6905 + ART. 6904 + ART. 6901

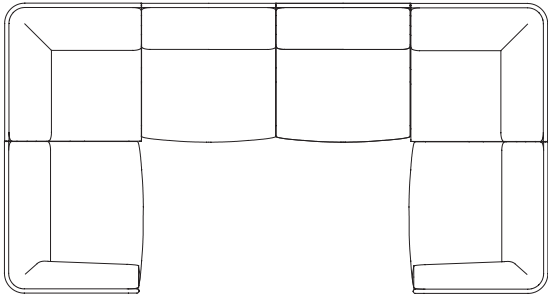

ART. 6902 + ART. 6905 + ART. 6905 + ART. 6903

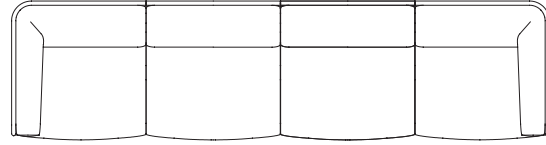

ART. 6900 + ART. 6904 + ART. 6905 + ART. 6901

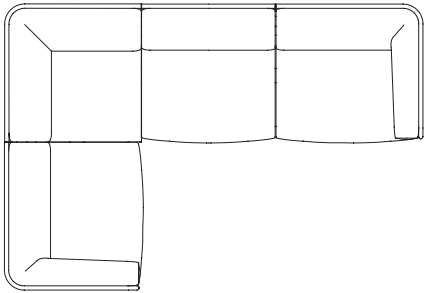

ART. 6902 + ART. 6905 + ART. 6904 + ART. 6903

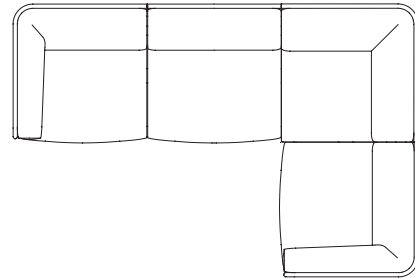

ART. 6933 + ART. 6901

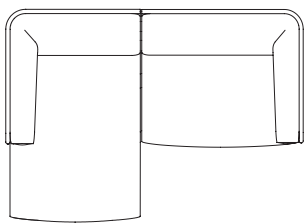

ART. 6900 + ART. 6934

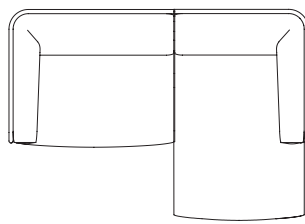

ART. 6933 + ART. 6905 + ART. 6901

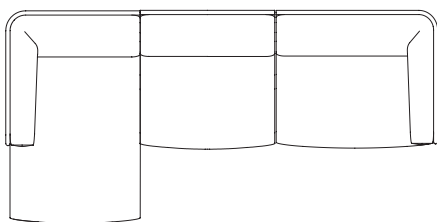

ART. 6900 + ART. 6905 + ART. 6934

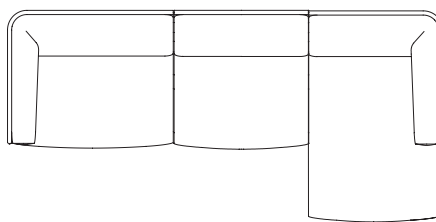

# Shaal

## Upholstery

A rigid padded panel gives shape to a backrest that welcomes the soft Shaal cushions.

Shaal is available in the traditional single-material versions that involve the same upholstery for the panel that wraps around the sofa and for its internal part made up of the seat and backrest cushions.

Additionally, to further exalt the sophistication of the encounter of these two elements, 5 special versions have been created that make it possible to match different materials in specially designed combinations.

### External panel

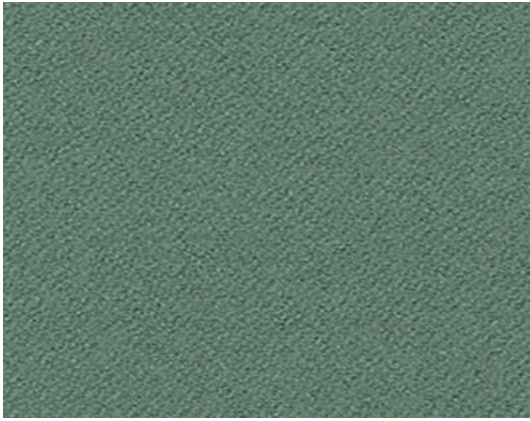

**Synergy — Camira**

74 colors

### Cushions

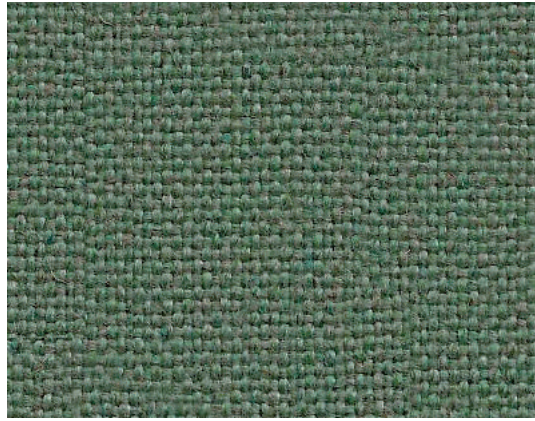

**Main Line Flax — Camira**

57 colors

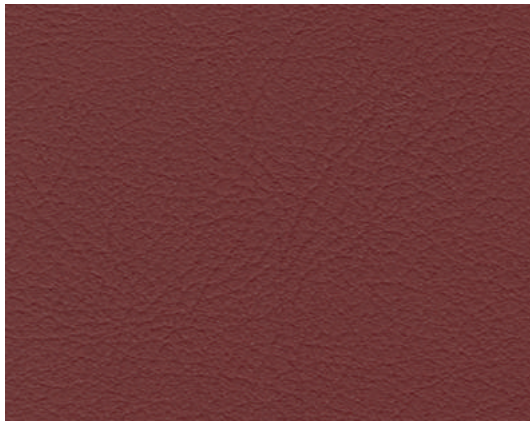

**Valencia — Spradling**

67 colors

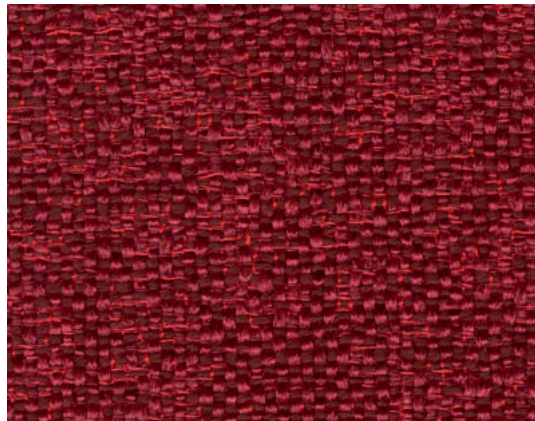

**Fabthirty — Rubelli**

60 colors

## External panel

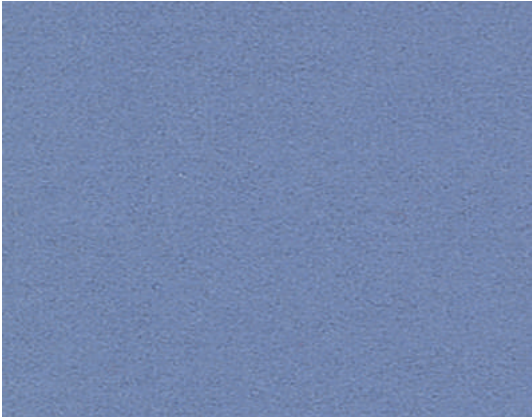

**Divina 3 — Kvadrat Raf Simons**

56 colors

## Cushions

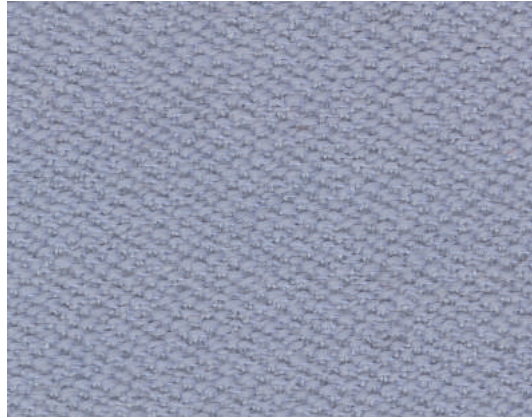

**Vidar 4 — Kvadrat Raf Simons**

41 colors

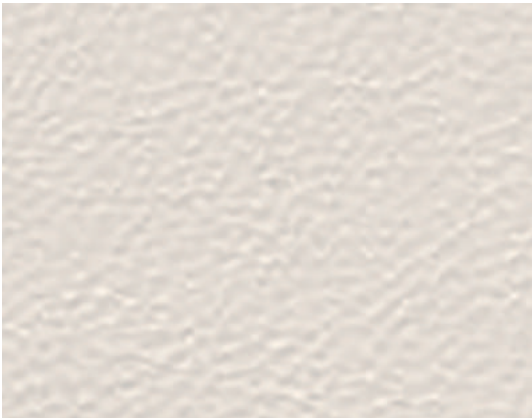

**Pelle Fiore — Arper**

11 colors

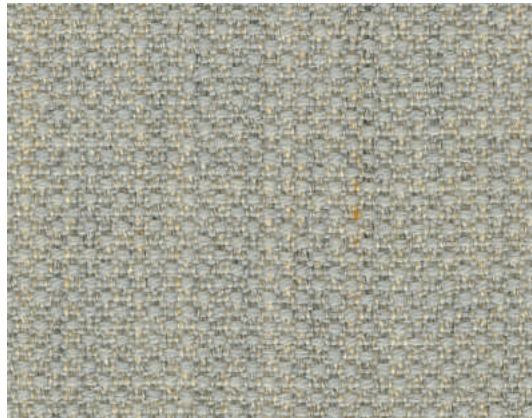

**Fiord 2 — Kvadrat**

39 colors

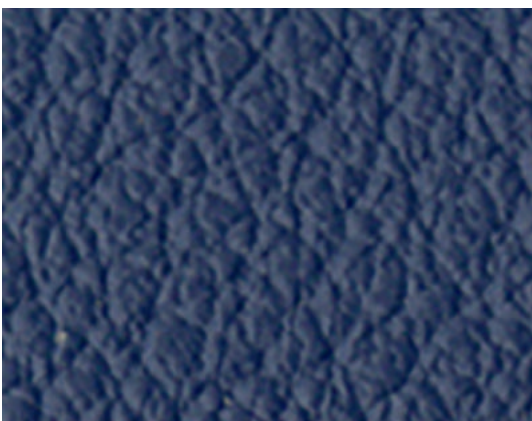

**ElmoSoft — Elmo**

70 colors



**Vidar 4 — Kvadrat Raf Simons**

41 colors



MODULE SEWING SCHEME

Soft leather

**ART. 6902**

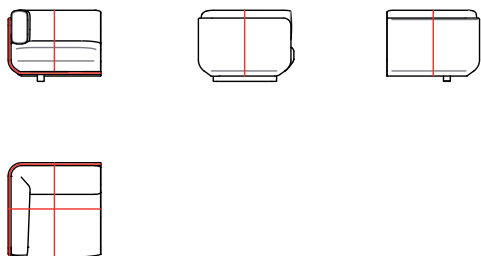

**ART. 6903**

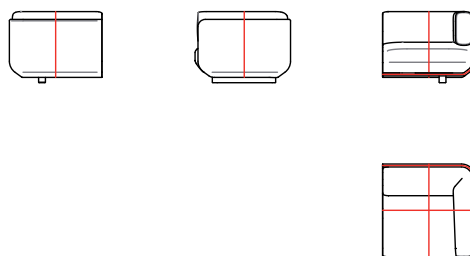

**ART. 6900**

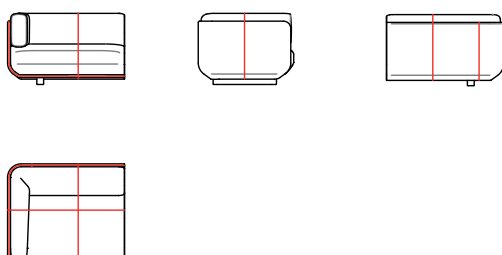

**ART. 6901**

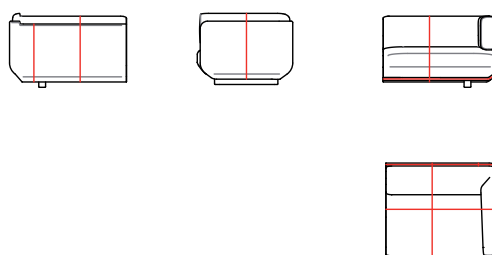

**ART. 6904**

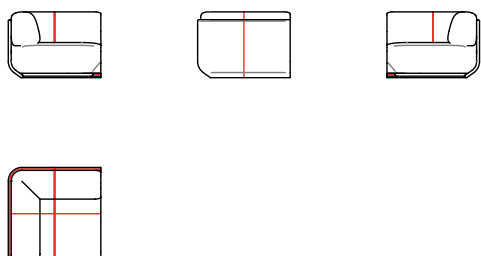

**ART. 6905**

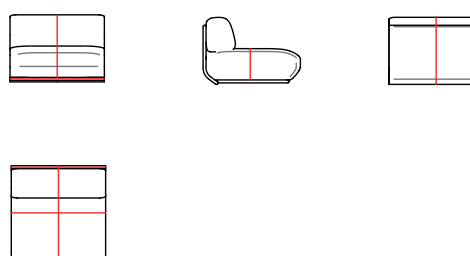

**ART. 6914**

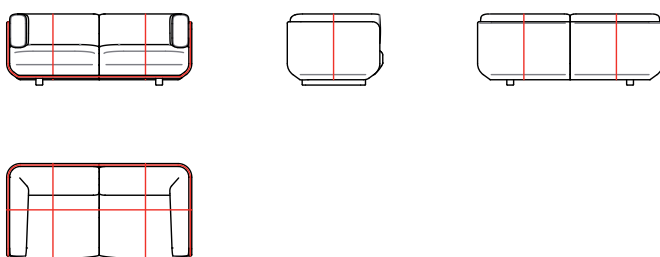

**ART. 6916**

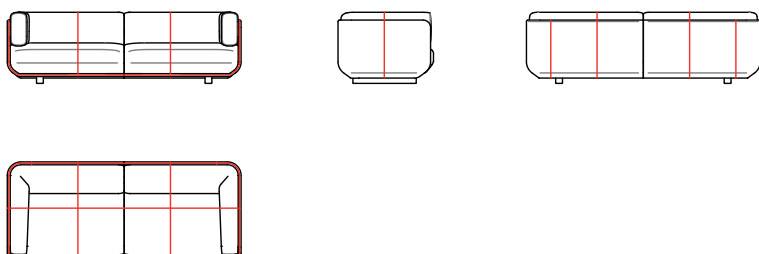

MODULE SEWING SCHEME

Soft leather

**ART. 6933**

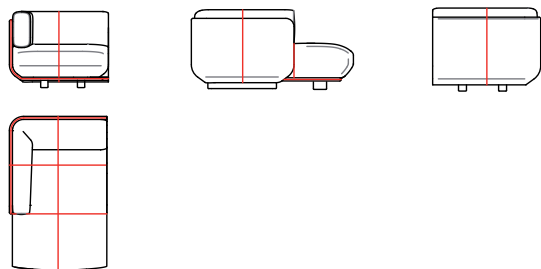

**ART. 6934**

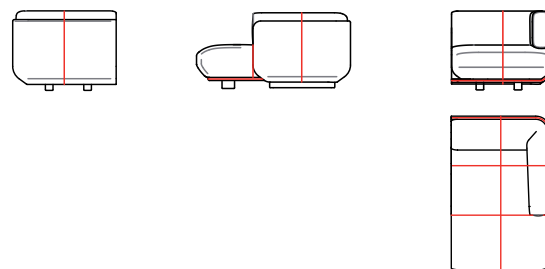

**ART. 6941**

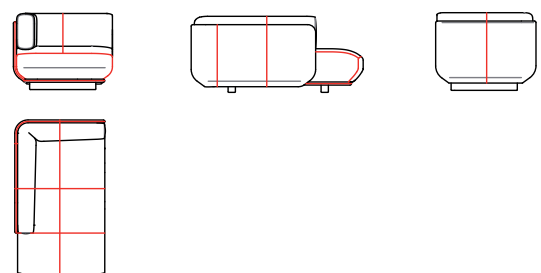

**ART. 6939**

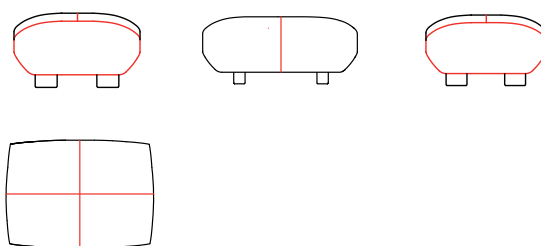

# MODULE SEWING SCHEME

Fabric / Coated fabric

## ART. 6902 — ART. 6910

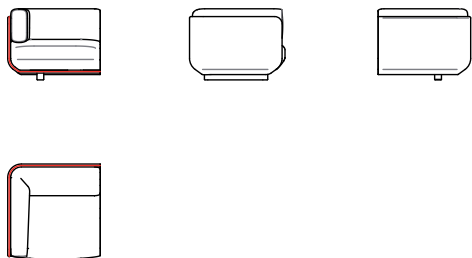

## ART. 6903 — ART. 6911

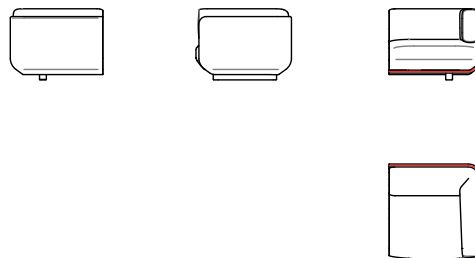

## ART. 6900 — ART. 6908

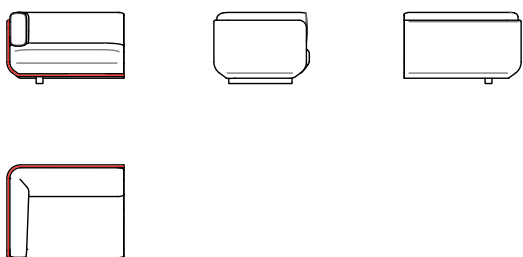

## ART. 6901 — ART. 6909

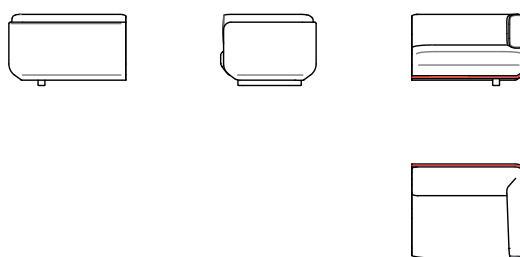

## ART. 6904 — ART. 6912

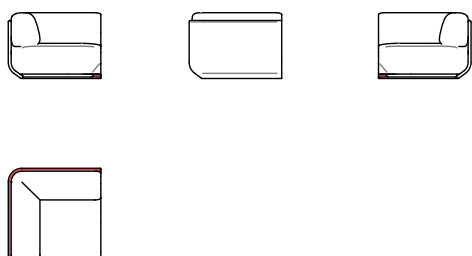

## ART. 6905 — ART. 6913

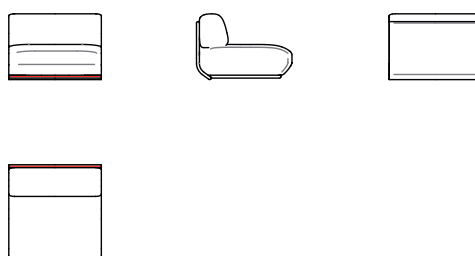

## ART. 6914 — ART. 6915

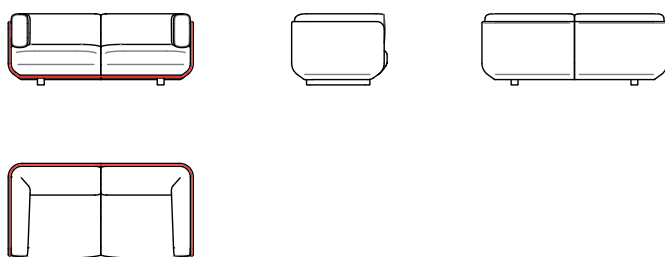

## ART. 6916 — ART. 6917

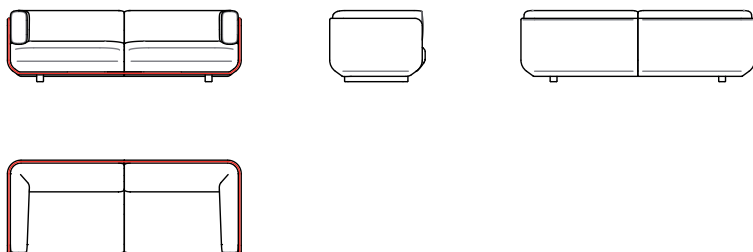

# MODULE SEWING SCHEME

Fabric / Coated fabric

## ART. 6933— ART. 6935

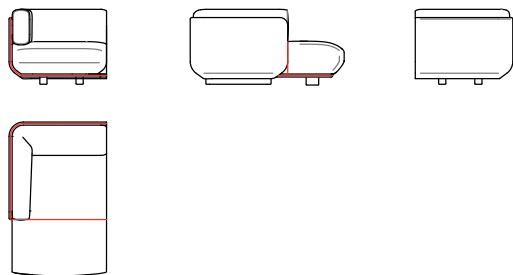

## ART. 6934 — ART. 6936

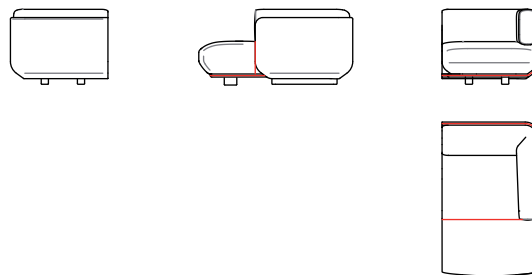

## ART. 6941 — ART. 6942

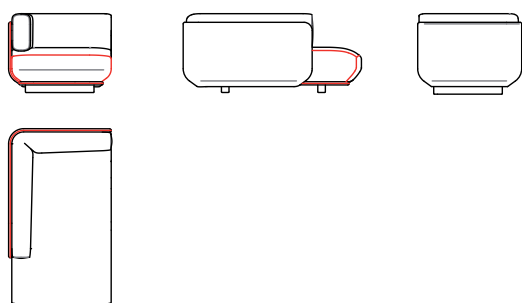

## ART. 6939

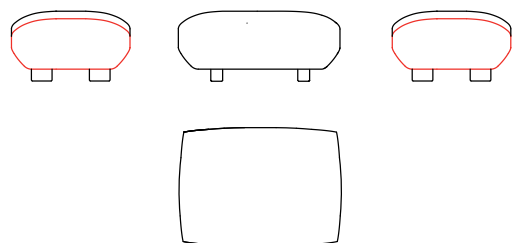



# MODULE SEWING SCHEME

Outer panel: leather / Cushions: fabric

**ART. 6910**

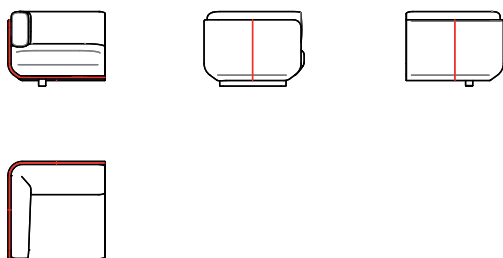

**ART. 6911**

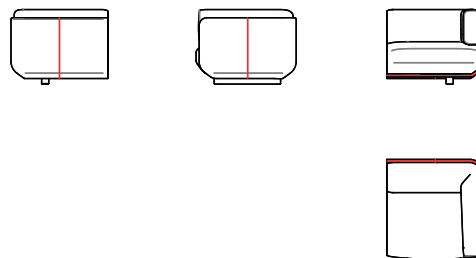

**ART. 6908**

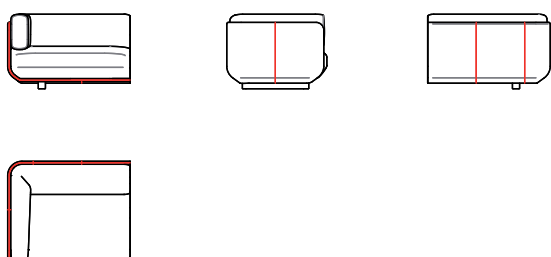

**ART. 6909**

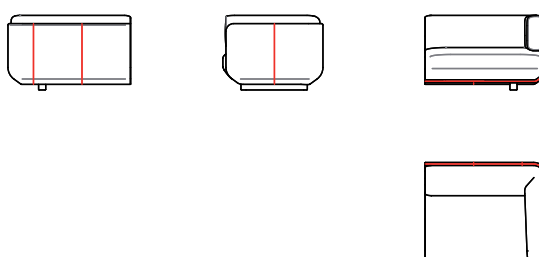

**ART. 6912**

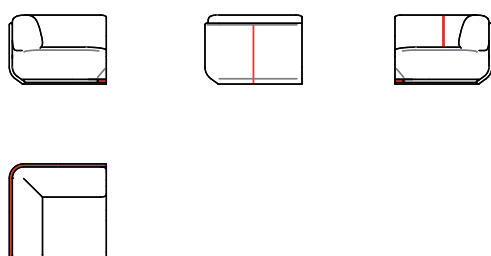

**ART. 6913**

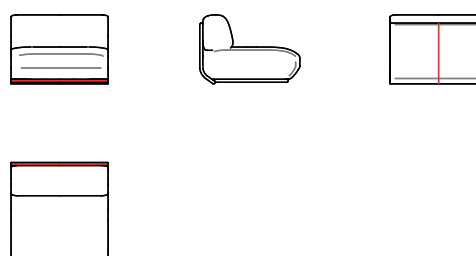

**ART. 6915**

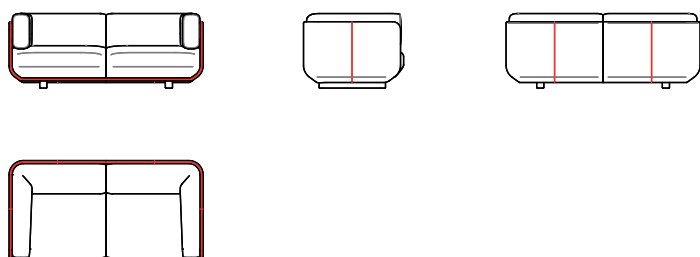

**ART. 6917**

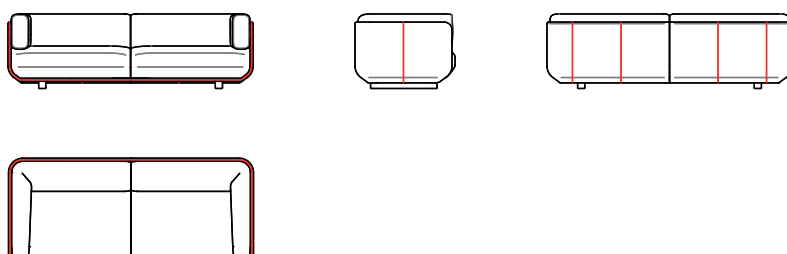

# MODULE SEWING SCHEME

Outer panel: leather / Cushions: fabric

**ART. 6935**

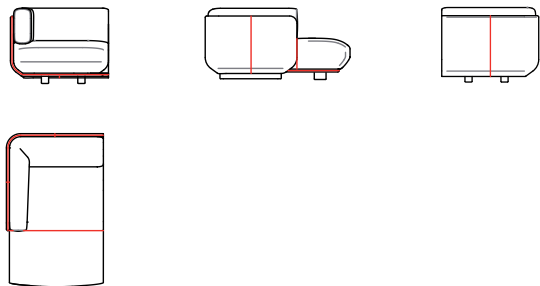

**ART. 6936**

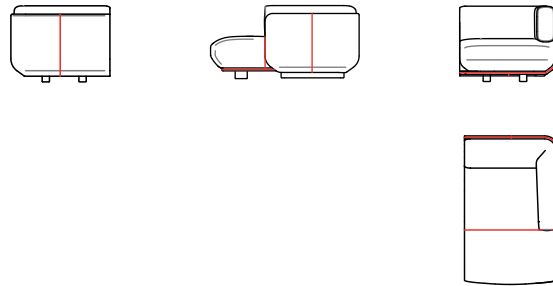

**ART. 6942**

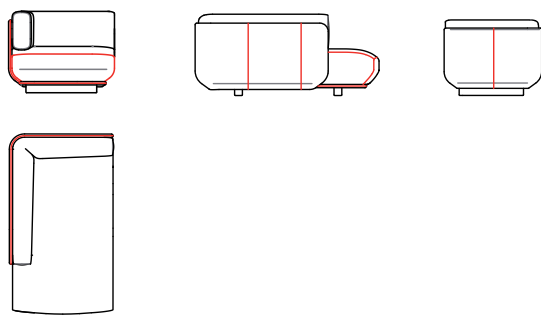

# Shaal Monomaterial Upholstery

Design by Doshi Levien, 2022



2-seater sofa configuration with an outer structure composed of a wraparound panel made of covered plywood. The outer panel and the cushions are upholstered with the same material: fabric, leather, coated fabric or customer's own material. The cushions have removable covers. Base in polypropylene made with recycled materials, equipped with height-adjustable glides.

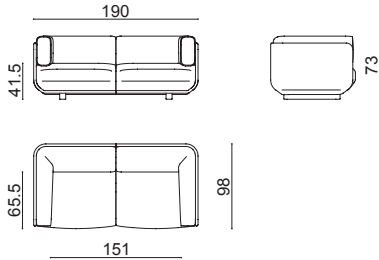

Accessories:  
 USB Art. 6001  
 Lumbar cushion 66x32 cm Art. 6906  
 Pillow 60x40 cm Art. 6907  
 Replacement cover set Art. 6930

SEK ART. 6914	A	B COM	C COL	D	E	F	G	H	I	J	K	L	M	ES
	67904	71442	74980	78518	82056	85594	89132	92670	96208	99746	103284	106822	110360	124514

SHIPMENT DETAILS	TECHNICAL SPECIFICATIONS	RESISTANCE TEST
<b>Art. 6914</b> 1 pz = 2  - kg 129/ m³ 2,076 	<b>Art.6914</b> COL requirement m² 44.46 H 140 cm. COM Meterage m 14.30	
FIRE RETARDANT TEST		

Frame Base



P25



# Shaal Monomaterial Upholstery

Design by Doshi Levien, 2022



3-seater sofa configuration with an outer structure composed of a wraparound panel made of covered plywood. The outer panel and the cushions are upholstered with the same material: fabric, leather, coated fabric or customer's own material. The cushions have removable covers. Base in polypropylene made with recycled materials, equipped with height-adjustable glides.

Accessories:

USB Art. 6001

Lumbar cushion 66x32 cm Art. 6906

Pillow 60x40 cm Art. 6907

Replacement cover set Art. 6932

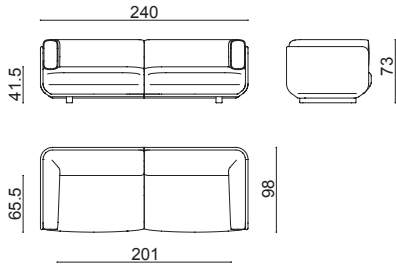

SEK ART. 6916	A	B COM	C COL	D	E	F	G	H	I	J	K	L	M	ES
	74460	78430	82400	86370	90340	94310	98280	102250	106220	110190	114160	118130	122100	137964

SHIPMENT DETAILS	TECHNICAL SPECIFICATIONS	RESISTANCE TEST
<b>Art. 6916</b> 1 pz = 2  - kg 150,6/ m³ 2,796 	<b>Art. 6916</b> COL requirement m² 46.80 H 140 cm. COM Meterage m 16.06	<ul style="list-style-type: none"> <li>• EN 1728:2012 - EN 16139:2013 6.10</li> <li>• EN 1728:2012 - EN 16139:2013 6.15</li> <li>• EN 1728:2012 - EN 16139:2013 6.17</li> <li>• EN 1728:2012 - EN 16139:2013 6.20</li> <li>• EN 1728:2012 - EN 16139:2013 6.25</li> <li>• EN 1728:2012 - EN 16139:2013 4.1-4.2</li> <li>• EN 1728:2012 - EN 16139:2013 6.6</li> <li>• EN 1022:2018 7.3</li> </ul>
<b>FIRE RETARDANT TEST</b>		

Frame Base



P25



# Shaal Monomaterial Upholstery



Design by Doshi Levien, 2023

Daybed with outer structure composed of a wraparound panel made of coated plywood. The outer panel and the inner cushions are upholstered with the same material: fabric, leather, coated fabric or customer's own material. The inner cushions have removable upholstery. Base in polypropylene made with recycled materials, equipped with height-adjustable glides.

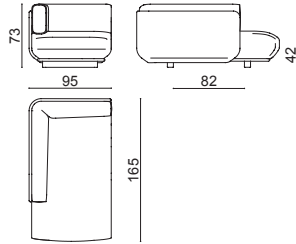

Accessories:  
 USB Art. 6001  
 Lumbar cushion 66x32 cm Art. 6906  
 Pillow 60x40 cm Art. 6907  
 Replacement cover set Art. 6943

SEK ART. 6941	A	B	C	D	E	F	G	H	I	J	K	L	M	ES
	61690	64219	66748	69277	71806	74335	76864	79393	81922	84451	86980	89509	92038	102151

SHIPMENT DETAILS	TECHNICAL SPECIFICATIONS	RESISTANCE TEST
<b>Art. 6941</b> 1 pz = 1  - kg 80/ m³ 1,86	<b>Art.6941</b> COL requirement m² 29,04 H 140 cm. COM Meterage m 10.373	<ul style="list-style-type: none"> <li>• EN 1728:2012 - EN 16139:2013 6.10</li> <li>• EN 1728:2012 - EN 16139:2013 6.15</li> <li>• EN 1728:2012 - EN 16139:2013 6.17</li> <li>• EN 1728:2012 - EN 16139:2013 6.20</li> <li>• EN 1728:2012 - EN 16139:2013 6.25</li> <li>• EN 1728:2012 - EN 16139:2013 6.4</li> <li>• EN 1728:2012 - EN 16139:2013 6.27.1</li> </ul> <ul style="list-style-type: none"> <li>• EN 1728:2012 - EN 16139:2013 6.11</li> <li>• EN 1728:2012 - EN 16139:2013 6.16</li> <li>• EN 1728:2012 - EN 16139:2013 6.18</li> <li>• EN 1728:2012 - EN 16139:2013 6.24</li> <li>• EN 1728:2012 - EN 16139:2013 6.26</li> <li>• EN 1728:2012 - EN 16139:2013 6.5</li> </ul>
<b>FIRE RETARDANT TEST</b>		

Frame Base



P25



# Shaal Monomaterial Upholstery

Design by Doshi Levien, 2023



Ottoman with removable upholstery in fabric, leather, coated fabric or customer's own material. Base in polypropylene made with recycled materials, equipped with height-adjustable glides.

Accessories:  
Replacement cover set Art. 6940

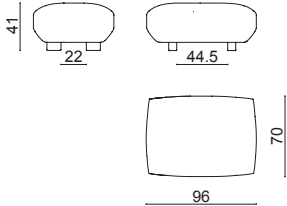

SEK ART. 6939	A	B	C	D	E	F	G	H	I	J	K	L	M	ES
	14651	15150	15649	16148	16647	17146	17645	18144	18643	19142	19641	20140	20639	22635

SHIPMENT DETAILS	TECHNICAL SPECIFICATIONS	RESISTANCE TEST
<b>Art. 6939</b> 1 pz = 1  - kg 5/ m³ 0,36	<b>Art.6939</b> COL requirement m² 7.44 H 140 cm. COM Meterage m 2.057	<ul style="list-style-type: none"> <li>• EN 1728:2012 - EN 16139:2013 6.15</li> <li>• EN 1728:2012 - EN 16139:2013 6.17</li> <li>• EN 1728:2012 - EN 16139:2013 6.24</li> <li>• EN 1728:2012 - EN 16139:2013 4.1-4.2</li> <li>• EN 1728:2012 - EN 16139:2013 6.5</li> <li>• EN 1728:2012 - EN 16139:2013 6.16</li> <li>• EN 1728:2012 - EN 16139:2013 6.18</li> <li>• EN 1728:2012 - EN 16139:2013 6.25</li> <li>• EN 1728:2012 - EN 16139:2013 6.4</li> <li>• EN 1022:2018</li> </ul>
FIRE RETARDANT TEST		

Frame Base



P25



# Shaal Monomaterial Upholstery

Design by Doshi Levien, 2022

Left or right end module, 1,5-seater. Outer structure composed of a wraparound panel made of covered plywood. The outer panel and the cushions are upholstered with the same material: fabric, leather, coated fabric or customer's own material. The cushions have removable covers. Base in polypropylene made with recycled materials, equipped with height-adjustable glides.

Accessories:  
 USB Art. 6001  
 Lumbar cushion 66x32 cm Art. 6906  
 Pillow 60x40 cm Art. 6907  
 Replacement cover set Art. 6918  
 Replacement cover set Art. 6919

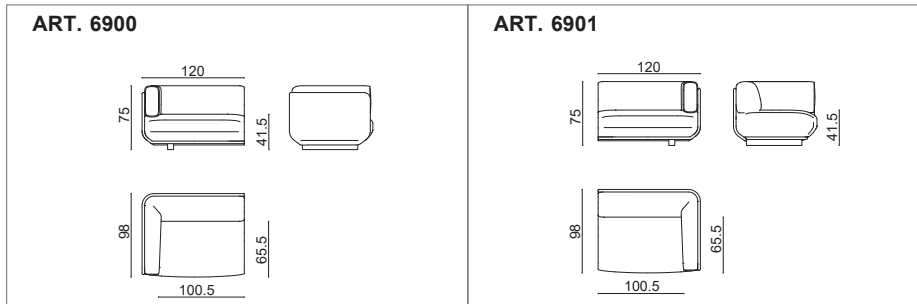

SEK ART. 6900	A	B COM	C COL	D	E	F	G	H	I	J	K	L	M	ES
Left end module	37230	39215	41200	43185	45170	47155	49140	51125	53110	55095	57080	59065	61050	68982
SEK ART. 6901	A	B COM	C COL	D	E	F	G	H	I	J	K	L	M	ES
Right end module	37230	39215	41200	43185	45170	47155	49140	51125	53110	55095	57080	59065	61050	68982

SHIPMENT DETAILS	TECHNICAL SPECIFICATIONS	RESISTANCE TEST
<b>Art. 6900</b> 1 pz = 1  - kg 75,3/ m³ 1,254 <b>Art. 6901</b> 1 pz = 1  - kg 75,3/ m³ 1,254	<b>Art.6900</b> COL requirement m² 23,40 H 140 cm. COM Meterage m 8.03 <b>Art.6901</b> COL requirement m² 23,40 H 140 cm. COM Meterage m 8.03	

Frame Base



P25



# Shaal Monomaterial Upholstery

Design by Doshi Levien, 2022

Left or right end module, 1-seater. Outer structure composed of a wraparound panel made of covered plywood. The outer panel and the cushions are upholstered with the same material: fabric, leather, coated fabric or customer's own material. The cushions have removable covers. Base in polypropylene made with recycled materials, equipped with height-adjustable glides.

Accessories:  
 USB Art. 6001  
 Lumbar cushion 66x32 cm Art. 6906  
 Pillow 60x40 cm Art. 6907  
 Replacement cover set Art. 6920  
 Replacement cover set Art. 6921

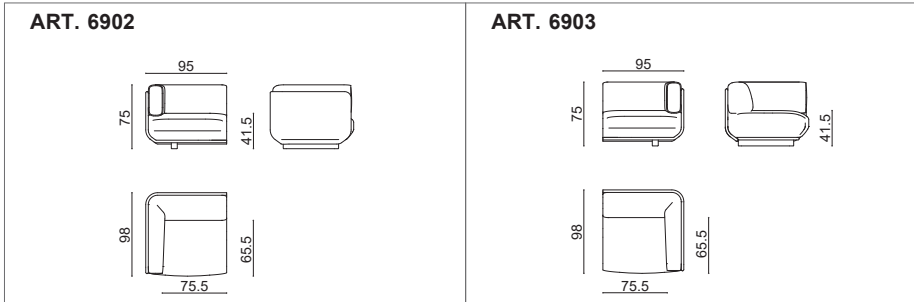

SEK ART. 6902	A	B COM	C COL	D	E	F	G	H	I	J	K	L	M	ES
Left end module	33952	35721	37490	39259	41028	42797	44566	46335	48104	49873	51642	53411	55180	62257
SEK ART. 6903	A	B COM	C COL	D	E	F	G	H	I	J	K	L	M	ES
Right end module	33952	35721	37490	39259	41028	42797	44566	46335	48104	49873	51642	53411	55180	62257

SHIPMENT DETAILS	TECHNICAL SPECIFICATIONS	RESISTANCE TEST
<b>Art. 6902</b> 1 pz = 1  - kg 64,5/ m³ 1,038 <b>Art. 6903</b> 1 pz = 1  - kg 64,5/ m³ 1,038	<b>Art.6902</b> COL requirement m² 22,23 H 140 cm. COM Meterage m 7.15 <b>Art.6903</b> COL requirement m² 22,23 H 140 cm. COM Meterage m 7.15	

Frame Base



P25





# Shaal Monomaterial Upholstery

Design by Doshi Levien, 2022

90° corner module and 1-seater central module. Outer structure composed of a wraparound panel made of covered plywood. The outer panel and the cushions are upholstered with the same material: fabric, leather, coated fabric or customer's own material. The cushions have removable covers. Base in polypropylene made with recycled materials, equipped with height-adjustable glides. The various configurations must always be completed with end modules.

Accessories:  
 USB Art. 6001  
 Lumbar cushion 66x32 cm Art. 6906  
 Pillow 60x40 cm Art. 6907  
 Replacement cover set Art. 6922  
 Replacement cover set Art. 6923

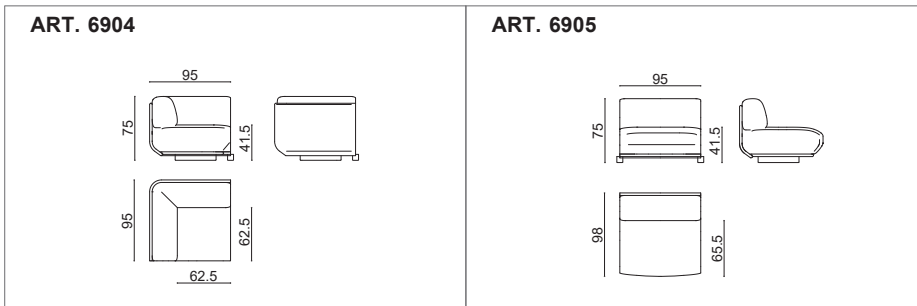

SEK ART. 6904	A	B COM	C COL	D	E	F	G	H	I	J	K	L	M	ES
90° corner module	32591	34156	35721	37286	38851	40416	41981	43546	45111	46676	48241	49806	51371	57630
SEK ART. 6905	A	B COM	C COL	D	E	F	G	H	I	J	K	L	M	ES
1-seater central module	24630	25867	27104	28341	29578	30815	32052	33289	34526	35763	37000	38237	39474	44407

SHIPMENT DETAILS	TECHNICAL SPECIFICATIONS	RESISTANCE TEST
<b>Art. 6904</b> 1 pz = 1  - kg 64,5/ m³ 1,038 <b>Art. 6905</b> 1 pz = 1  - kg 56/ m³ 1,038	<b>Art.6904</b> COL requirement m² 22,23 H 140 cm. COM Meterage m 6.33 <b>Art.6905</b> COL requirement m² 22,23 H 140 cm. COM Meterage m 5.01	

Frame Base



P25



# Shaal Monomaterial Upholstery

Design by Doshi Levien, 2023

Chaise longue end module left or right. Outer structure composed of a wraparound panel made of coated plywood. The outer panel and the inner cushions are upholstered with the same material: fabric, leather, coated fabric or customer's own material. The inner cushions have removable upholstery. Base in polypropylene made with recycled materials, equipped with height-adjustable glides.

Accessories:  
 USB Art. 6001  
 Lumbar cushion 66x32 cm Art. 6906  
 Pillow 60x40 cm Art. 6907  
 Replacement cover set Art. 6937  
 Replacement cover set Art. 6938

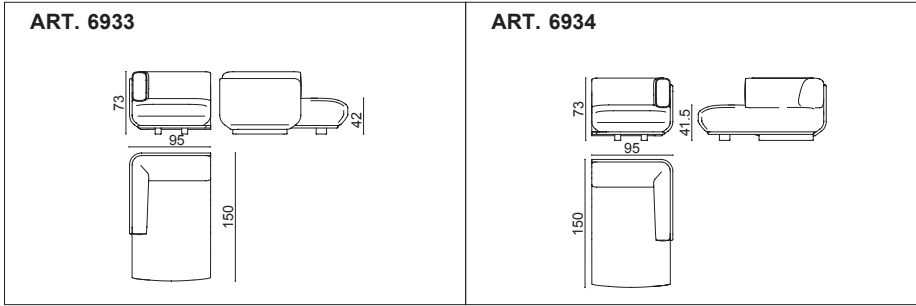

<b>SEK ART. 6933</b>	A	B	C	D	E	F	G	H	I	J	K	L	M	ES
Left end chaise module	58685	60772	62859	64946	67033	69120	71207	73294	75381	77468	79555	81642	83729	92070
<b>SEK ART. 6934</b>	A	B	C	D	E	F	G	H	I	J	K	L	M	ES
Left end chaise module	58685	60772	62859	64946	67033	69120	71207	73294	75381	77468	79555	81642	83729	92070

SHIPMENT DETAILS	TECHNICAL SPECIFICATIONS	RESISTANCE TEST
<b>Art. 6933</b> 1 pz = 1  - kg 75/ m³ 1,86 <b>Art. 6934</b> 1 pz = 1  - kg 75/ m³ 1,86	<b>Art.6933</b> COL requirement m² 25,68 H 140 cm. COM Meterage m 8.173  <b>Art.6934</b> COL requirement m² 25,68 H 140 cm. COM Meterage m 8.173	
FIRE RETARDANT TEST		

Frame Base



P25



# Shaal Bimaterial Upholstery

Design by Doshi Levien, 2022



2-seater sofa configuration with an outer structure composed of a wraparound panel made of covered plywood. The outer panel and the cushions are upholstered with different materials in specially designed combinations. The cushions have removable covers. Base in polypropylene made with recycled materials, equipped with height-adjustable glides.

Accessories:  
 USB Art. 6001  
 Lumbar cushion 66x32 cm Art. 6906  
 Pillow 60x40 cm Art. 6907  
 Replacement cover set Art. 6930

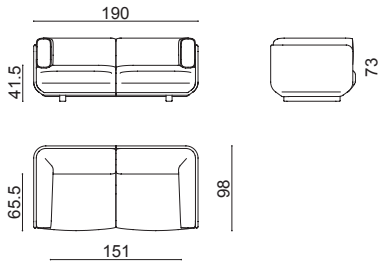

<b>SEK ART. 6915</b>	Synergy + Main Line Flax	Valencia + Fabthirty	Divina 3 + Vidar	Pelle Fiore + Fiord 2	ElmoSoft + Vidar
	76476	81898	92558	99746	110792

SHIPMENT DETAILS	TECHNICAL SPECIFICATIONS	RESISTANCE TEST
<b>Art. 6915</b> 1 pz = 2  - kg 129/ m² 2,07 		
<b>FIRE RETARDANT TEST</b>		

Frame Base



P25



# Shaal Bimaterial Upholstery



Design by Doshi Levien, 2022

3-seater sofa configuration with an outer structure composed of a wraparound panel made of covered plywood. The outer panel and the cushions are upholstered with different materials in specially designed combinations. The cushions have removable covers. Base in polypropylene made with recycled materials, equipped with height-adjustable glides.

Accessories:  
 USB Art. 6001  
 Lumbar cushion 66x32 cm Art. 6906  
 Pillow 60x40 cm Art. 6907  
 Replacement cover set Art. 6932

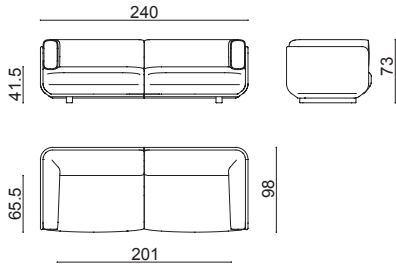

<b>SEK ART. 6917</b>	Synergy + Main Line Flax	Valencia + Fabthirty	Divina 3 + Vidar	Pelle Fiore + Fiord 2	ElmoSoft + Vidar
	84052	90108	102786	110180	121248

SHIPMENT DETAILS	TECHNICAL SPECIFICATIONS	RESISTANCE TEST
<b>Art. 6917</b> 1 pz = 2  - kg 150,6/ m³ 2,796 		
<b>FIRE RETARDANT TEST</b>		

Frame Base



P25



# Shaal Bimaterial Upholstery



Design by Doshi Levien, 2023

Daybed with outer structure composed of a wraparound panel made of coated plywood. The outer panel and the inner cushions are upholstered with different materials in specially designed combinations. The inner cushions have removable upholstery. Base in polypropylene made with recycled materials, equipped with height-adjustable glides.

Accessories:  
 USB Art. 6001  
 Lumbar cushion 66x32 cm Art. 6906  
 Pillow 60x40 cm Art. 6907  
 Replacement cover set Art. 6943

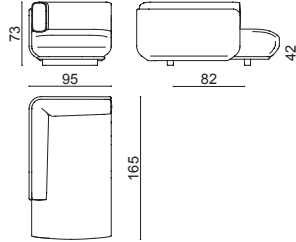

<b>SEK ART. 6942</b>	Synergy + Main Line Flax	Valencia + Fabthirty	Divina 3 + Vidar	Pelle Fiore + Fiord 2	ElmoSoft + Vidar
	68085	71953	80412	84450	92456

SHIPMENT DETAILS	TECHNICAL SPECIFICATIONS	RESISTANCE TEST
<b>Art. 6942</b> 1 pz = 1  - kg 80/ m³ 1,86	<b>Art.6942</b> COL requirement m² 29,04 H 140 cm. COM Meterage m 10.353	
<b>FIRE RETARDANT TEST</b>		

Frame Base



P25



# Shaal Bimaterial Upholstery

Design by Doshi Levien, 2022

Left or right end module, 1,5-seater. Outer structure composed of a wraparound panel made of covered plywood. The outer panel and the cushions are upholstered with different materials in specially designed combinations. The cushions have removable covers. Base in polypropylene made with recycled materials, equipped with height-adjustable glides.

Accessories:  
 USB Art. 6001  
 Lumbar cushion 66x32 cm Art. 6906  
 Pillow 60x40 cm Art. 6907  
 Replacement cover set Art. 6918  
 Replacement cover set Art. 6919

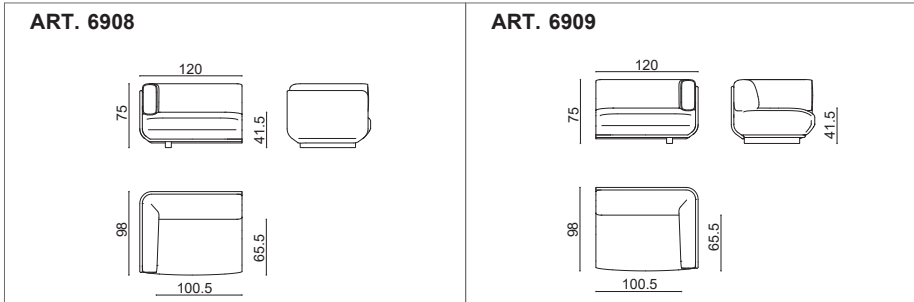

<b>SEK ART. 6908</b>	Synergy + Main Line Flax	Valencia + Fabthirty	Divina 3 + Vidar	Fiord 2 + Pelle Fiore	ElmoSoft + Vidar
	42026	45054	51393	55090	60624
<b>SEK ART. 6909</b>	Synergy + Main Line Flax	Valencia + Fabthirty	Divina 3 + Vidar	Pelle Fiore + Fiord 2	ElmoSoft + Vidar
	42026	45054	51393	55090	60624

SHIPMENT DETAILS	TECHNICAL SPECIFICATIONS	RESISTANCE TEST
<b>Art. 6908</b> 1 pz = 1  - kg 75,3/ m³ 1,254 <b>Art. 6909</b> 1 pz = 1  - kg 75,3/ m³ 1,254		

Frame Base



P25



# Shaal Bimaterial Upholstery

Design by Doshi Levien, 2022

Left or right end module, 1-seater. Outer structure composed of a wraparound panel made of covered plywood. The outer panel and the cushions are upholstered with different materials in specially designed combinations. The cushions have removable covers. Base in polypropylene made with recycled materials, equipped with height-adjustable glides.

Accessories:  
 USB Art. 6001  
 Lumbar cushion 66x32 cm Art. 6906  
 Pillow 60x40 cm Art. 6907  
 Replacement cover set Art. 6920  
 Replacement cover set Art. 6921

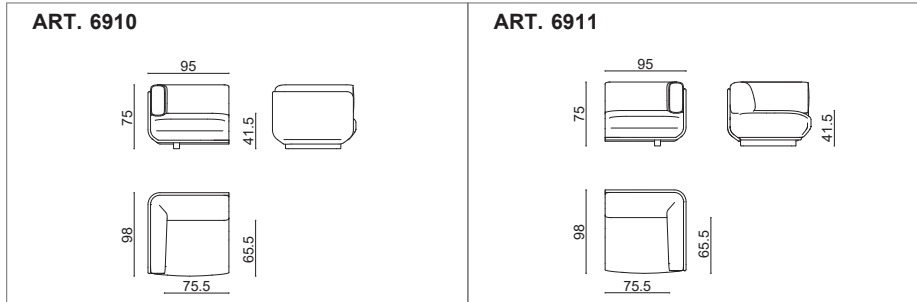

<b>SEK ART. 6910</b>	Synergy + Main Line Flax	Valencia + Fabthirty	Divina 3 + Vidar	Pelle Fiore + Fiord 2	ElmoSoft + Vidar
	38238	40949	46279	49873	55396
<b>SEK ART. 6911</b>	Synergy + Main Line Flax	Valencia + Fabthirty	Divina 3 + Vidar	Pelle Fiore + Fiord 2	ElmoSoft + Vidar
	38238	40949	46279	49873	55396

SHIPMENT DETAILS	TECHNICAL SPECIFICATIONS	RESISTANCE TEST
<b>Art. 6910</b> 1 pz = 1  - kg 64,5/ m³ 1,038 <b>Art. 6911</b> 1 pz = 1  - kg 64,5/ m³ 1,038		

Frame Base



P25



# Shaal Bimaterial Upholstery

Design by Doshi Levien, 2022

90° corner module and 1-seater central module. Outer structure composed of a wraparound panel made of covered plywood. The outer panel and the cushions are upholstered with different materials in specially designed combinations. The cushions have removable covers. Base in polypropylene made with recycled materials, equipped with height-adjustable glides. The configurations must always be completed with end modules.

Accessories:  
 USB Art. 6001  
 Lumbar cushion 66x32 cm Art. 6906  
 Pillow 60x40 cm Art. 6907  
 Replacement cover set Art. 6922  
 Replacement cover set Art. 6923

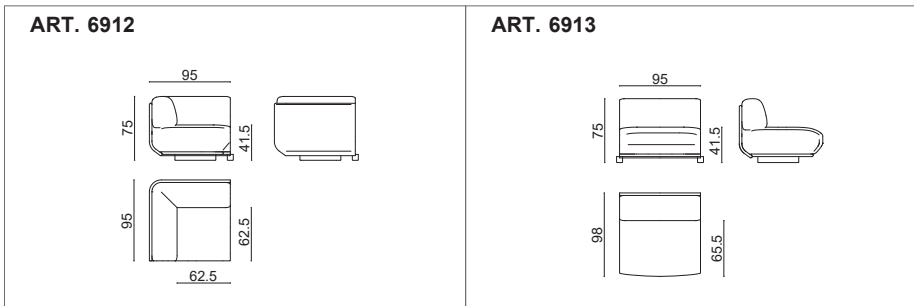

SEK ART. 6912	Synergy + Main Line Flax	Valencia + Fabthirty	Divina 3 + Vidar	Pelle Fiore + Fiord 2	ElmoSoft + Vidar
	36436	38828	45360	48683	54512
SEK ART. 6913	Synergy + Main Line Flax	Valencia + Fabthirty	Divina 3 + Vidar	Pelle Fiore + Fiord 2	ElmoSoft + Vidar
	27647	29541	34894	40030	45088

SHIPMENT DETAILS	TECHNICAL SPECIFICATIONS	RESISTANCE TEST
<b>Art. 6912</b> 1 pz = 1  - kg 64,5/ m³ 1,038 <b>Art. 6913</b> 1 pz = 1  - kg 56/ m³ 1,038		

Frame Base



P25





# Shaal Bimaterial Upholstery

Design by Doshi Levien, 2023

Chaise longue end module left or right. Outer structure composed of a wraparound panel made of coated plywood. The outer panel and the inner cushions are upholstered with different materials in specially designed combinations. The inner cushions have removable upholstery. Base in polypropylene made with recycled materials, equipped with height-adjustable glides.

Accessories:  
 USB Art. 6001  
 Lumbar cushion 66x32 cm Art. 6906  
 Pillow 60x40 cm Art. 6907  
 Replacement cover set Art. 6937  
 Replacement cover set Art. 6938

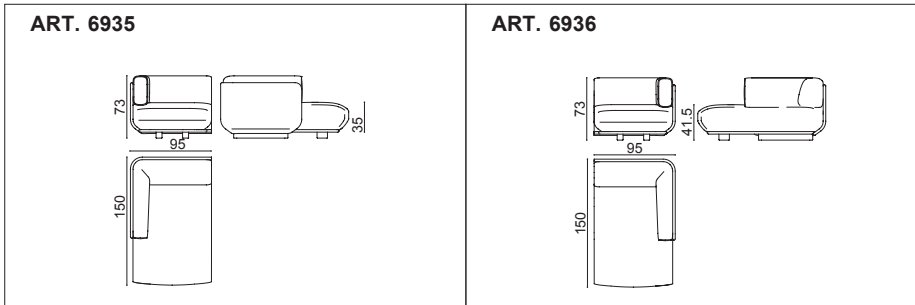

<b>SEK ART. 6935</b>	Synergy + Main Line Flax	Valencia + Fabthirty	Divina 3 + Vidar	Pelle Fiore + Fiord 2	ElmoSoft + Vidar
	64116	67303	74266	77464	84744
<b>SEK ART. 6936</b>	Synergy + Main Line Flax	Valencia + Fabthirty	Divina 3 + Vidar	Pelle Fiore + Fiord 2	ElmoSoft + Vidar
	64116	67303	74266	77464	84744

SHIPMENT DETAILS	TECHNICAL SPECIFICATIONS	RESISTANCE TEST
<b>Art. 6935</b> 1 pz = 1  - kg 75/ m³ 1,86 <b>Art. 6936</b> 1 pz = 1  - kg 75/ m³ 1,86	<b>Art.6935</b> COL requirement m² 25,68 H 140 cm. COM Meterage m 8.137 <b>Art.6936</b> COL requirement m² 25,68 H 140 cm. COM Meterage m 8.173	
<b>FIRE RETARDANT TEST</b>		

Frame Base



P25



# Shaal

Design by Doshi Levien, 2022

Cushions available in two different sizes, upholstered in fabric, leather, coated fabric or customer's own material.

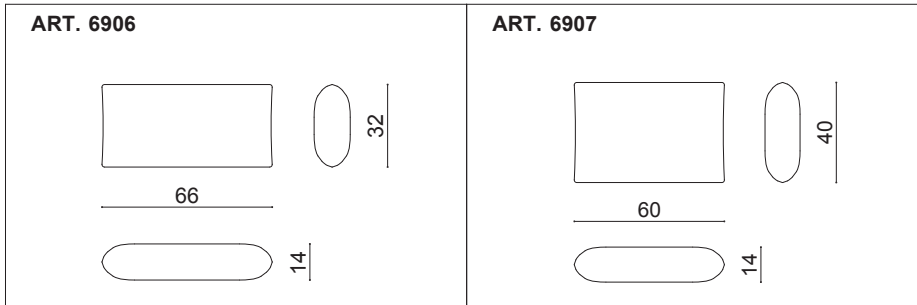

<b>SEK ART. 6906</b>	A	B COM	C COL	D	E	F	G	H	I	J	K	L	M	ES
Lumbar cushion 66 x 32 cm	1622	1838	2054	2270	2486	2702	2918	3134	3350	3566	3782	3998	4214	5070
<b>SEK ART. 6907</b>	A	B COM	C COL	D	E	F	G	H	I	J	K	L	M	ES
Cushion 60 x 40 cm	1599	1803	2007	2211	2415	2619	2823	3027	3231	3435	3639	3843	4047	4865

SHIPMENT DETAILS	TECHNICAL SPECIFICATIONS	RESISTANCE TEST
<b>Art. 6906</b> 1 pz = 1  - kg 3,024/ m³ 0,069 <b>Art. 6907</b> 1 pz = 1  - kg 3,17/ m³ 0,069	<b>Art.6906</b> COL requirement m² 2.15 H 140 cm. COM Meterage m 0.88 <b>Art.6907</b> COL requirement m² 2.07 H 140 cm. COM Meterage m 0.83	
<b>FIRE RETARDANT TEST</b>		





Frame Base



# Accessories

Design by Doshi Levien, 2022

<b>SEK ART. 6920</b>	A	B COM	C COL	D	E	F	G	H	I	J	K	L	M	ES
SPARE COVER — Art. 6902 and Art. 6910	4434	5432	6430	7428	8426	9424	10422	11420	12418	13416	14414	15412	16410	20401
<b>SEK ART. 6921</b>	A	B COM	C COL	D	E	F	G	H	I	J	K	L	M	ES
SPARE COVER — Art. 6903 and Art. 6911	4434	5432	6430	7428	8426	9424	10422	11420	12418	13416	14414	15412	16410	20401
<b>SEK ART. 6930</b>	A	B COM	C COL	D	E	F	G	H	I	J	K	L	M	ES
SPARE COVER — Art. 6914 and Art. 6915	8868	10864	12860	14856	16852	18848	20844	22840	24836	26832	28828	30824	32820	40802
<b>SEK ART. 6932</b>	A	B COM	C COL	D	E	F	G	H	I	J	K	L	M	ES
SPARE COVER — Art.6916 e Art. 6917	9776	12090	14404	16718	19032	21346	23660	25974	28288	30602	32916	35230	37544	46790





SHIPMENT DETAILS	TECHNICAL SPECIFICATIONS	RESISTANCE TEST
<b>Art. 6920</b> 1 pz = 1  - kg 2,604/ m³ 0,03 <b>Art. 6921</b> 1 pz = 1  - kg 2,604/ m³ 0,03 <b>Art. 6930</b> 1 pz = 2  - kg 5,208/ m³ 0,06 <b>Art. 6932</b> 1 pz = 2  - kg 5,436/ m³ 0,06	<b>Art.6920</b> COL requirement m² 14,82 H 140 cm. COM Meterage m 3.91 <b>Art.6921</b> COL requirement m² 14,82 H 140 cm. COM Meterage m 3.91 <b>Art.6930</b> COL requirement m² 29,64 H 140 cm. COM Meterage m 7.81 <b>Art.6932</b> COL requirement m² 31,20 H 140 cm. COM Meterage m 9.02	
<b>FIRE RETARDANT TEST</b>		



# Accessories

Design by Doshi Levien, 2022

<b>SEK ART. 6918</b>	A	B COM	C COL	D	E	F	G	H	I	J	K	L	M	ES
SPARE COVER — Art. 6900 and Art. 6908	4888	6045	7202	8359	9516	10673	11830	12987	14144	15301	16458	17615	18772	23395
<b>SEK ART. 6919</b>	A	B COM	C COL	D	E	F	G	H	I	J	K	L	M	ES
SPARE COVER — Art. 6901 and Art. 6909	4888	6045	7202	8359	9516	10673	11830	12987	14144	15301	16458	17615	18772	23395
<b>SEK ART. 6922</b>	A	B COM	C COL	D	E	F	G	H	I	J	K	L	M	ES
SPARE COVER — Art. 6904 and Art. 6912	4457	5478	6499	7520	8541	9562	10583	11604	12625	13646	14667	15688	16709	20787
<b>SEK ART. 6923</b>	A	B COM	C COL	D	E	F	G	H	I	J	K	L	M	ES
SPARE COVER — Art. 6905 and Art. 6913	4196	5024	5852	6680	7508	8336	9164	9992	10820	11648	12476	13304	14132	17441



SHIPMENT DETAILS	TECHNICAL SPECIFICATIONS	RESISTANCE TEST
<p><b>Art. 6918</b> 1 pz = 1  - kg 2,718/ m³ 0,03</p> <p><b>Art. 6919</b> 1 pz = 1  - kg 2,718/ m³ 0,03</p> <p><b>Art. 6922</b> 1 pz = 1  - kg 2,822/ m³ 0,03</p> <p><b>Art. 6923</b> 1 pz = 1  - kg 2,604/ m³ 0,03</p>	<p><b>Art.6918</b> COL requirement m² 15.60 H 140 cm. COM Meterage m 4.51</p> <p><b>Art.6919</b> COL requirement m² 15.60 H 140 cm. COM Meterage m 4.51</p> <p><b>Art.6922</b> COL requirement m² 14.82 H 140 cm. COM Meterage m 3.96</p> <p><b>Art.6923</b> COL requirement m² 14.82 H 140 cm. COM Meterage m 3.25</p>	
FIRE RETARDANT TEST		



# Accessories

Design by Doshi Levien, 2023

<b>SEK ART. 6937</b>	A	B	C	D	E	F	G	H	I	J	K	L	M	ES
SPARE COVER — Art. 6933 and Art. 6935	7133	8403	9673	10943	12213	13483	14753	16023	17293	18563	19833	21103	22373	27455
<b>SEK ART. 6938</b>	A	B	C	D	E	F	G	H	I	J	K	L	M	ES
SPARE COVER — Art. 6934 and Art. 6936	7133	8403	9673	10943	12213	13483	14753	16023	17293	18563	19833	21103	22373	27455
<b>SEK ART. 6940</b>	A	B	C	D	E	F	G	H	I	J	K	L	M	ES
SPARE COVER — Art. 6939	1894	2393	2892	3391	3890	4389	4888	5387	5886	6385	6884	7383	7882	9878
<b>SEK ART. 6943</b>	A	B	C	D	E	F	G	H	I	J	K	L	M	ES
SPARE COVER — Art. 6941 and Art. 6942	8902	11431	13960	16489	19018	21547	24076	26605	29134	31663	34192	36721	39250	49364

SHIPMENT DETAILS	TECHNICAL SPECIFICATIONS	RESISTANCE TEST
<p><b>Art. 6937</b> 1 pz = 1  - kg 2,82/ m³ 0,03</p> <p><b>Art. 6938</b> 1 pz = 1  - kg 2,82/ m³ 0,03</p> <p><b>Art. 6940</b> 1 pz = 1  - kg 1,8/ m³ 0,03</p>	<p><b>Art.6937</b> COL requirement m² 18,36 H 140 cm. COM Meterage m 4.972</p> <p><b>Art.6938</b> COL requirement m² 18,36 H 140 cm. COM Meterage m 4.972</p> <p><b>Art.6940</b> COL requirement m² 7,44 H 140 cm. COM Meterage m 2.057</p> <p><b>Art.6943</b> COL requirement m² 29,04 H 140 cm. COM Meterage m 10.373</p>	
<b>FIRE RETARDANT TEST</b>		



## Accessories

### **SEK ART. 6001**



Power supply kit consisting of 2 units with 2 USB A sockets each, 1 power supply unit and cable clamps. Electric cable not included.

1655

SHIPMENT DETAILS	TECHNICAL SPECIFICATIONS	RESISTANCE TEST
<b>FIRE RETARDANT TEST</b>		





# STEEVE

Design by Jean-Marie Massaud

2015

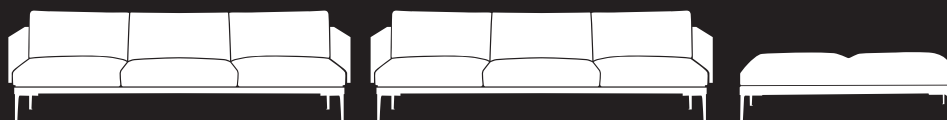



# Steeve

## Collection overview

---

### Upholstery Types

In the entirely upholstered version the frame and cushions can be in the same material and color (A), or in the same material but in different colours (B).



---

(A) — Entirely upholstered with a single material - one colour

(B) — Entirely upholstered with a single material in different colours

The exposed frame version is finished with veneered wood externally, while the frame internal upholstery is in the same material and colour as the seat and backrest cushions. (C)



---

(C) — Wood external frame with internal upholstery in a single material - one colour

### Options



---

— Cushions

# Steeve

---

## Free-standing

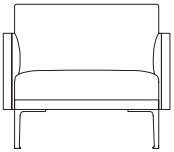

---

Armchair

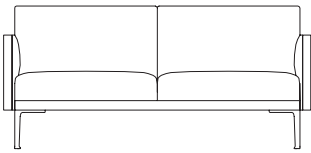

Sofa — 2 seats

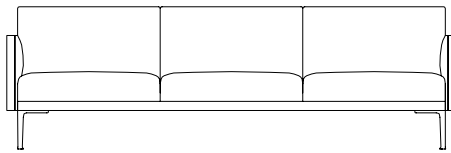

Sofa — 3 seats

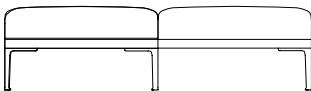

Bench — 2 seats

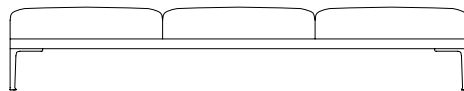

Bench — 3 seats

---

# Steeve

---

## Modular system

### 2 seats

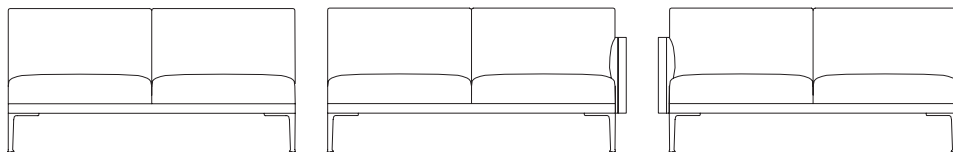

Without armrest

With right armrest

With left armrest

### 3 seats

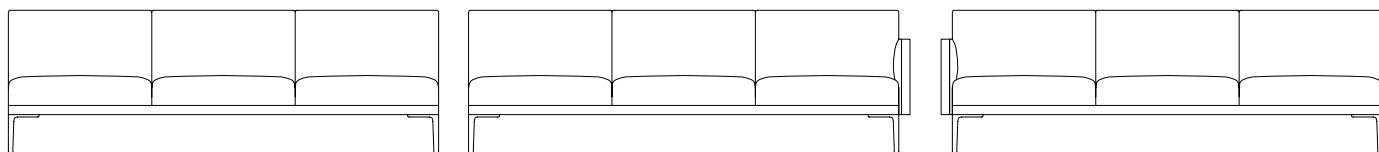

Without armrest

With right armrest

With left armrest

### Corner components

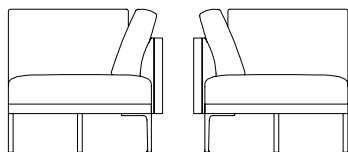

90° dx

90° sx

# Steeve

## Examples of possible layouts

For linear compositions of modules, Art 5315 (seat link, for linear modules only) needs to be ordered. Please see final page for price.

In case of Steeve composition made of 2 or more linear modules, backrest must be fitted with holes for linking device (option available without surcharge and must be requested at order confirmation).

ART. 5234 + ART. 5254 + ART. 5233

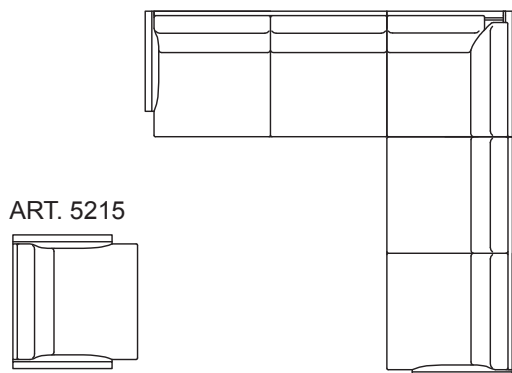

ART. 5254+ ART. 5232 + ART. 5232 + ART. 5258 + ART. 5233

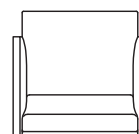
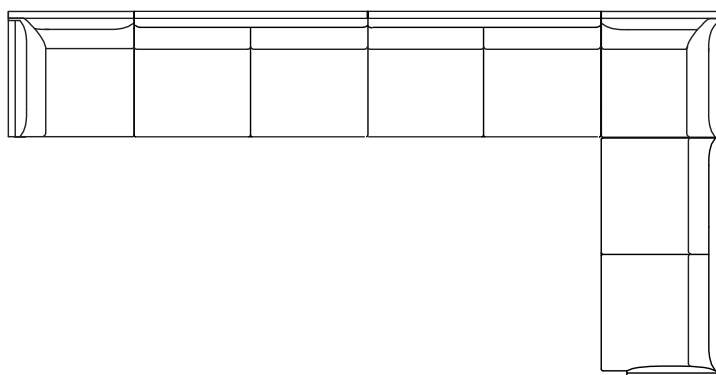

ART. 5215

---

### Art. 5315

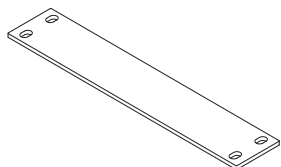

---

Link kit for linear modules

For compositions of modules, art 5315 (seat link, for linear modules only) needs to be ordered. When placing the order, please specify if back needs to be connected as well (option offered without surcharge).



# Steeve Upholstered Frame

Design by Jean-Marie Massaud, 2015

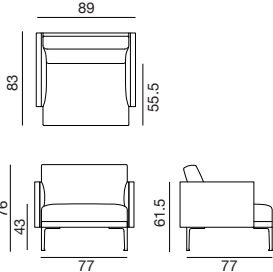

Armchair available with armrests. The frame can be entirely upholstered with a single material in just one colour, or with a single material in two colours. The seat and backrest cushions have the same upholstery as the frame internal side.

SEK ART. 5215	A	B COM	C COL	D	E	F	G	H	I	J	K	L	M	ES
Entirely upholstered with a single material in just one color	27982	29625	31268	32911	34554	36197	37840	39483	41126	42769	44412	46055	47698	54391
Entirely upholstered with a single material in two colors	286	512	738	964	1190	1416	1642	1868	2094	2320	2546	2772	2998	4073

SHIPMENT DETAILS	TECHNICAL SPECIFICATIONS	RESISTANCE TEST
<b>Art. 5215</b> 1 pz = 1  - kg 54,55/ m³ 0,508	<b>Art.5215</b> COL requirement m² 10,54 H 140 cm. COM Meterage m 5.5 *Classe 1, 2, 1IM: fire retardant version available with surcharge and eventual minimum batch	<ul style="list-style-type: none"> <li>• EN 1728:2012 - EN 16139:2013 6.10</li> <li>• EN 1728:2012 - EN 16139:2013 6.15</li> <li>• EN 1728:2012 - EN 16139:2013 6.17</li> <li>• EN 1728:2012 - EN 16139:2013 6.20</li> <li>• EN 1728:2012 - EN 16139:2013 6.25</li> <li>• EN 1728:2012 - EN 16139:2013 6.4</li> <li>• EN 1728:2012 - EN 16139:2013 6.6</li> </ul> <ul style="list-style-type: none"> <li>• EN 1728:2012 - EN 16139:2013 6.11</li> <li>• EN 1728:2012 - EN 16139:2013 6.16</li> <li>• EN 1728:2012 - EN 16139:2013 6.18</li> <li>• EN 1728:2012 - EN 16139:2013 6.24</li> <li>• EN 1728:2012 - EN 16139:2013 6.26</li> <li>• EN 1728:2012 - EN 16139:2013 6.5</li> </ul>
<b>FIRE RETARDANT TEST</b> Classe 1IM Omologazione Italia Coated fabric Valencia Spradling. • FIRE RETARDANT VERSION WITH SURCHARGE * Classe 1IM Omologazione Italia Remix 3 Kvadrat.		

Frame Base



V44  
matt



# Steeve Upholstered Frame

Design by Jean-Marie Massaud, 2015

Two seat sofa available in the following versions: with or without armrests, with right or left armrest. The frame can be entirely upholstered with a single material in just one colour, or with a single material in different colours. The seat and backrest cushions have the same upholstery as the frame internal side.

Accessories:  
Link Kit Art. 5315

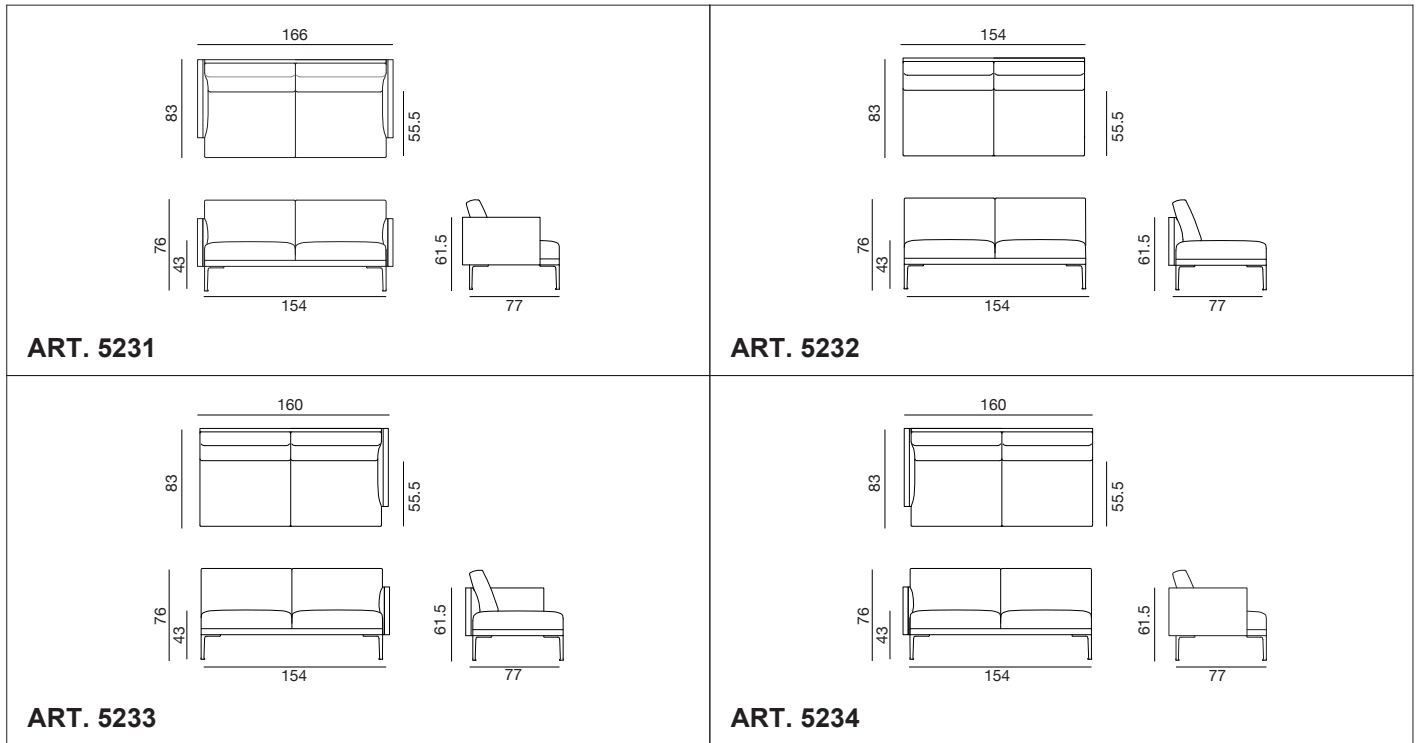

SHIPMENT DETAILS	TECHNICAL SPECIFICATIONS	RESISTANCE TEST
<p><b>Art. 5231</b> 1 pz = 1  - kg 84,6/ m³ 0,889</p> <p><b>Art. 5232</b> 1 pz = 1  - kg 67,88/ m³ 0,889</p> <p><b>Art. 5233</b> 1 pz = 1  - kg 76,24/ m³ 0,889</p> <p><b>Art. 5234</b> 1 pz = 1  - kg 76,24/ m³ 0,889</p>	<p><b>Art.5231</b> COL requirement m² 17.5 H 140 cm. COM Meterage m 8.51 *Classe 1, 2, 11M: fire retardant version available with surcharge and eventual minimum batch</p> <p><b>Art.5232</b> COL requirement m² 13.83 H 140 cm. COM Meterage m 6.7 *Classe 1, 2, 11M: fire retardant version available with surcharge and eventual minimum batch</p> <p><b>Art.5233</b> COL requirement m² 16.06 H 140 cm. COM Meterage m 7.57 *Classe 1, 2, 11M: fire retardant version available with surcharge and eventual minimum batch</p> <p><b>Art.5234</b> COL requirement m² 16.06 H 140 cm. COM Meterage m 7.57 *Classe 1, 2, 11M: fire retardant version available with surcharge and eventual minimum batch</p>	



# Steeve Upholstered Frame

Design by Jean-Marie Massaud, 2015

<b>SEK ART. 5231</b>	A	B COM	C COL	D	E	F	G	H	I	J	K	L	M	ES
Entirely upholstered with a single material in just one color	39924	42495	45066	47637	50208	52779	55350	57921	60492	63063	65634	68205	70776	80944
Entirely upholstered with a single material in two colors	+ 500	+ 917	+ 1334	+ 1751	+ 2168	+ 2585	+ 3002	+ 3419	+ 3836	+ 4253	+ 4670	+ 5087	+ 5504	+ 6858
<b>SEK ART. 5232</b>														
A	B COM	C COL	D	E	F	G	H	I	J	K	L	M	ES	
Entirely upholstered with a single material in just one color	32958	35065	37172	39279	41386	43493	45600	47707	49814	51921	54028	56135	58242	66667
Entirely upholstered with a single material in two colors	+ 500	+ 917	+ 1334	+ 1751	+ 2168	+ 2585	+ 3002	+ 3419	+ 3836	+ 4253	+ 4670	+ 5087	+ 5504	+ 6858
<b>SEK ART. 5233</b>														
A	B COM	C COL	D	E	F	G	H	I	J	K	L	M	ES	
Entirely upholstered with a single material in just one color	36460	38841	41222	43603	45984	48365	50746	53127	55508	57889	60270	62651	65032	74645
Entirely upholstered with a single material in two colors	+ 500	+ 917	+ 1334	+ 1751	+ 2168	+ 2585	+ 3002	+ 3419	+ 3836	+ 4253	+ 4670	+ 5087	+ 5504	+ 6858
<b>SEK ART. 5234</b>														
A	B COM	C COL	D	E	F	G	H	I	J	K	L	M	ES	
Entirely upholstered with a single material in just one color	36460	38841	41222	43603	45984	48365	50746	53127	55508	57889	60270	62651	65032	74645
Entirely upholstered with a single material in two colors	+ 500	+ 917	+ 1334	+ 1751	+ 2168	+ 2585	+ 3002	+ 3419	+ 3836	+ 4253	+ 4670	+ 5087	+ 5504	+ 6858
<b>FIRE RETARDANT TEST</b>														
Classe 1IM Omologazione Italia Coated fabric Valencia Spradling.														
• FIRE RETARDANT VERSION WITH SURCHARGE * Classe 1IM Omologazione Italia Remix 3 Kvadrat.														

Frame Base





# Steeve Upholstered Frame





Design by Jean-Marie Massaud, 2015

Three seat sofa available in the following versions: with or without armrests, with right or left armrest. The frame can be entirely upholstered with a single material in just one colour, or with a single material in different colours. The seat and backrest cushions have the same upholstery as the frame internal side.

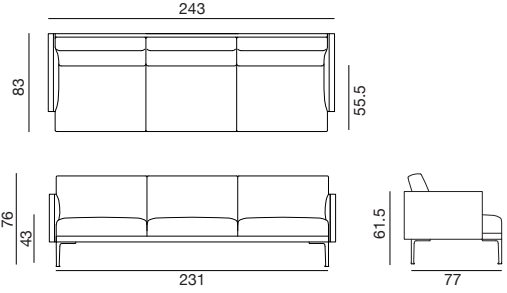
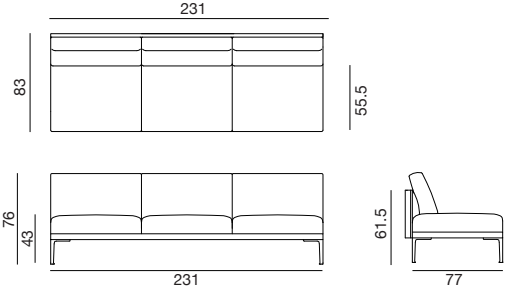
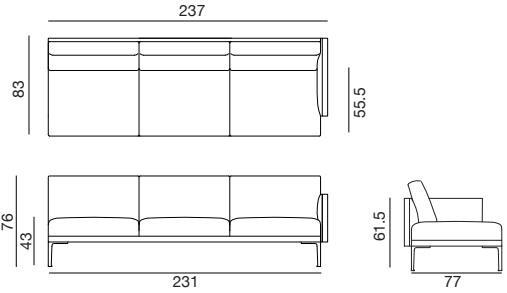
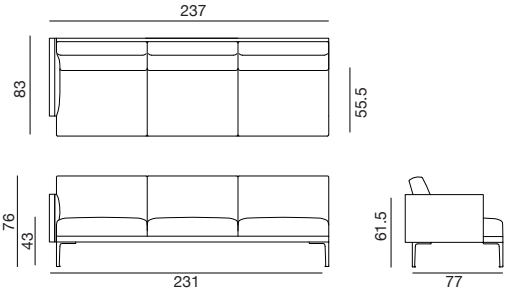

Accessories:  
Link Kit Art. 5315

 <p><b>ART. 5247</b></p>	 <p><b>ART. 5248</b></p>
 <p><b>ART. 5249</b></p>	 <p><b>ART. 5250</b></p>

SHIPMENT DETAILS	TECHNICAL SPECIFICATIONS	RESISTANCE TEST
<p><b>Art. 5247</b> 1 pz = 1  - kg 114,9/ m³ 1,27</p> <p><b>Art. 5248</b> 1 pz = 1  - kg 98,18/ m³ 1,27</p> <p><b>Art. 5249</b> 1 pz = 1  - kg 106,5/ m³ 1,27</p> <p><b>Art. 5250</b> 1 pz = 1  - kg 106,5/ m³ 1,27</p>	<p><b>Art.5247</b> COL requirement m² 25,58 H 140 cm. COM Meterage m 11,77 *Classe 1, 2, 11M: fire retardant version available with surcharge and eventual minimum batch</p> <p><b>Art.5248</b> COL requirement m² 20,62 H 140 cm. COM Meterage m 9,68 *Classe 1, 2, 11M: fire retardant version available with surcharge and eventual minimum batch</p> <p><b>Art.5249</b> COL requirement m² 23,04 H 140 cm. COM Meterage m 10,63 *Classe 1, 2, 11M: fire retardant version available with surcharge and eventual minimum batch</p> <p><b>Art.5250</b> COL requirement m² 23,04 H 140 cm. COM Meterage m 10,63 *Classe 1, 2, 11M: fire retardant version available with surcharge and eventual minimum batch</p>	<ul style="list-style-type: none"> <li>• EN 1728:2012 - EN 16139:2013 6.10</li> <li>• EN 1728:2012 - EN 16139:2013 6.15</li> <li>• EN 1728:2012 - EN 16139:2013 6.17</li> <li>• EN 1728:2012 - EN 16139:2013 6.20</li> <li>• EN 1728:2012 - EN 16139:2013 6.25</li> <li>• EN 1728:2012 - EN 16139:2013 6.4</li> <li>• EN 1728:2012 - EN 16139:2013 6.11</li> <li>• EN 1728:2012 - EN 16139:2013 6.16</li> <li>• EN 1728:2012 - EN 16139:2013 6.18</li> <li>• EN 1728:2012 - EN 16139:2013 6.24</li> <li>• EN 1728:2012 - EN 16139:2013 6.26</li> <li>• EN 1728:2012 - EN 16139:2013 6.5</li> </ul>



# Steeve Upholstered Frame

Design by Jean-Marie Massaud, 2015

<b>SEK ART. 5247</b>	A	B COM	C COL	D	E	F	G	H	I	J	K	L	M	ES
Entirely upholstered with a single material in just one color	50045	53557	57069	60581	64093	67605	71117	74629	78141	81653	85165	88677	92189	106163
Entirely upholstered with a single material in two colors	+ 690	+ 1261	+ 1832	+ 2403	+ 2974	+ 3545	+ 4116	+ 4687	+ 5258	+ 5829	+ 6400	+ 6971	+ 7542	+ 9895
<b>SEK ART. 5248</b>	A	B COM	C COL	D	E	F	G	H	I	J	K	L	M	ES
Entirely upholstered with a single material in just one color	43140	46105	49070	52035	55000	57965	60930	63895	66860	69825	72790	75755	78720	90529
Entirely upholstered with a single material in two colors	+ 690	+ 1261	+ 1832	+ 2403	+ 2974	+ 3545	+ 4116	+ 4687	+ 5258	+ 5829	+ 6400	+ 6971	+ 7542	+ 9895
<b>SEK ART. 5249</b>	A	B COM	C COL	D	E	F	G	H	I	J	K	L	M	ES
Entirely upholstered with a single material in just one color	46652	49962	53272	56582	59892	63202	66512	69822	73132	76442	79752	83062	86372	99459
Entirely upholstered with a single material in two colors	+ 690	+ 1261	+ 1832	+ 2403	+ 2974	+ 3545	+ 4116	+ 4687	+ 5258	+ 5829	+ 6400	+ 6971	+ 7542	+ 9895
<b>SEK ART. 5250</b>	A	B COM	C COL	D	E	F	G	H	I	J	K	L	M	ES
Entirely upholstered with a single material in just one color	46652	49962	53272	56582	59892	63202	66512	69822	73132	76442	79752	83062	86372	99459
Entirely upholstered with a single material in two colors	+ 690	+ 1261	+ 1832	+ 2403	+ 2974	+ 3545	+ 4116	+ 4687	+ 5258	+ 5829	+ 6400	+ 6971	+ 7542	+ 9895
<b>FIRE RETARDANT TEST</b>														
Classe 1IM Omologazione Italia Coated fabric Valencia Spradling.														
• FIRE RETARDANT VERSION WITH SURCHARGE * Classe 1IM Omologazione Italia Remix 3 Kvadrat.														

Frame Base



# Steeve Upholstered Frame

Design by Jean-Marie Massaud, 2015

Right or left 90° corner components, already equipped with seat links. The frame can be entirely upholstered with a single material in just one colour, or with a single material in two colours. The seat and backrest cushions have the same upholstery as the frame internal side.

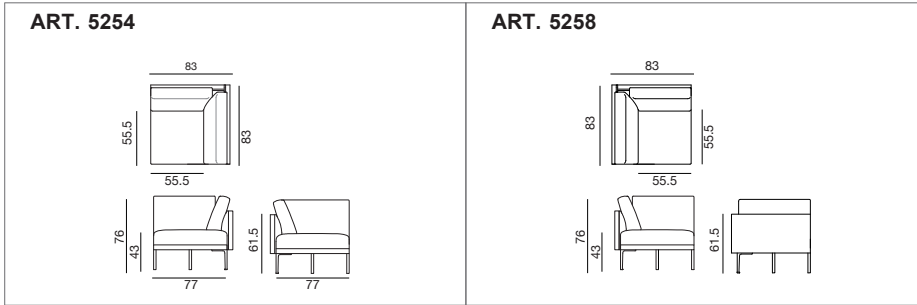

SEK ART. 5254	A	B COM	C COL	D	E	F	G	H	I	J	K	L	M	ES
Entirely upholstered with a single material in just one color	24576	26244	27912	29580	31248	32916	34584	36252	37920	39588	41256	42924	44592	51462
Entirely upholstered with a single material in two colors	143	262	381	500	619	738	857	976	1095	1214	1333	1452	1571	2263
SEK ART. 5258	A	B COM	C COL	D	E	F	G	H	I	J	K	L	M	ES
Entirely upholstered with a single material in just one color	24576	26244	27912	29580	31248	32916	34584	36252	37920	39588	41256	42924	44592	51462
Entirely upholstered with a single material in two colors	143	262	381	500	619	738	857	976	1095	1214	1333	1452	1571	2263

SHIPMENT DETAILS	TECHNICAL SPECIFICATIONS	RESISTANCE TEST
<b>Art. 5254</b> 1 pz = 1  - kg 53,18/ m³ 0,508 <b>Art. 5258</b> 1 pz = 1  - kg 53,18/ m³ 0,508	<b>Art. 5254</b> COL requirement m² 8.52 H 140 cm. COM Meterage m 5.51 *Classe 1, 2, 11M: fire retardant version available with surcharge and eventual minimum batch <b>Art. 5258</b> COL requirement m² 8.52 H 140 cm. COM Meterage m 5.51 *Classe 1, 2, 11M: fire retardant version available with surcharge and eventual minimum batch	
Classe 11M Omologazione Italia Coated fabric Valencia Spradling. • FIRE RETARDANT VERSION WITH SURCHARGE * Classe 11M Omologazione Italia Remix 3 Kvadrat.		

Frame Base



# Steeve Wooden Frame

Design by Jean-Marie Massaud, 2015



Armchair available with armrests. Frame with reconstituted veneer on the external side and with fabric, leather or coated fabric on the inside. The seat and backrest cushions have the same upholstery as the frame internal side.

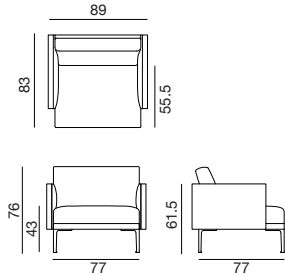

SEK ART. 5211	A	B COM	C COL	D	E	F	G	H	I	J	K	L	M	ES
External side wood + inside upholstered with a single material in just one color	33935	35316	36697	38078	39459	40840	42221	43602	44983	46364	47745	49126	50507	55891

SHIPMENT DETAILS	TECHNICAL SPECIFICATIONS	RESISTANCE TEST
<b>Art. 5211</b> 1 pz = 1  - kg 54,55/ m³ 0,508	<b>Art. 5211</b> COL requirement m² 8.15 H 140 cm. COM Meterage m 3.85 *Classe 1, 2, 1IM: fire retardant version available with surcharge and eventual minimum batch	<ul style="list-style-type: none"> <li>• EN 1728:2012 - EN 16139:2013 6.10</li> <li>• EN 1728:2012 - EN 16139:2013 6.15</li> <li>• EN 1728:2012 - EN 16139:2013 6.17</li> <li>• EN 1728:2012 - EN 16139:2013 6.20</li> <li>• EN 1728:2012 - EN 16139:2013 6.25</li> <li>• EN 1728:2012 - EN 16139:2013 6.4</li> <li>• EN 1728:2012 - EN 16139:2013 6.6</li> </ul> <ul style="list-style-type: none"> <li>• EN 1728:2012 - EN 16139:2013 6.11</li> <li>• EN 1728:2012 - EN 16139:2013 6.16</li> <li>• EN 1728:2012 - EN 16139:2013 6.18</li> <li>• EN 1728:2012 - EN 16139:2013 6.24</li> <li>• EN 1728:2012 - EN 16139:2013 6.26</li> <li>• EN 1728:2012 - EN 16139:2013 6.5</li> </ul>
<b>FIRE RETARDANT TEST</b> Classe 1IM Omologazione Italia Coated fabric Valencia Spradling. • FIRE RETARDANT VERSION WITH SURCHARGE * Classe 1IM Omologazione Italia Remix 3 Kvadrat.		

Frame Base



V44  
matt

Top



L0006 L0022 L0028



# Steeve Wooden Frame





Design by Jean-Marie Massaud, 2015

Two seat sofa available in the following versions: with or without armrests, with right or left armrest. Frame with reconstituted veneer on the external side and with fabric, leather or coated fabric on the inside. The seat and backrest cushions have the same upholstery as the frame internal side.

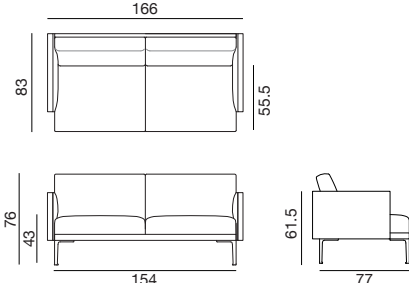
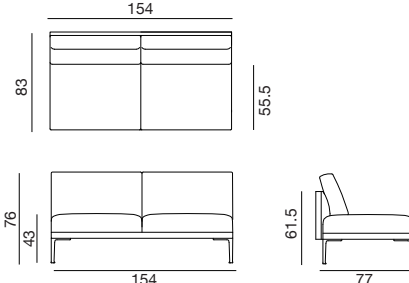
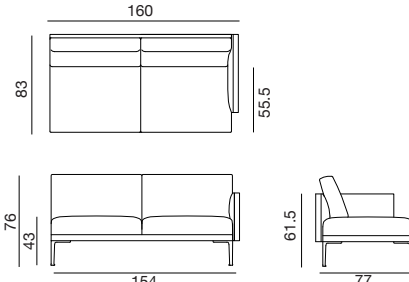
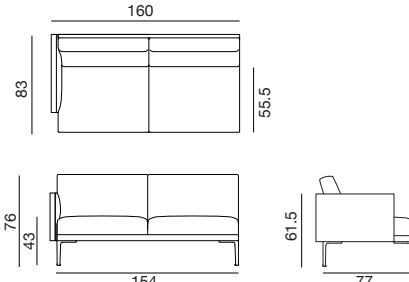
Accessories:  
Link Kit Art. 5315



 <p><b>ART. 5227</b></p>	 <p><b>ART. 5228</b></p>
 <p><b>ART. 5229</b></p>	 <p><b>ART. 5230</b></p>

SHIPMENT DETAILS	TECHNICAL SPECIFICATIONS	RESISTANCE TEST
<p><b>Art. 5227</b> 1 pz = 1  - kg 84,6/ m³ 0,889</p> <p><b>Art. 5228</b> 1 pz = 1  - kg 67,88/ m³ 0,889</p> <p><b>Art. 5229</b> 1 pz = 1  - kg 76,24/ m³ 0,889</p> <p><b>Art. 5230</b> 1 pz = 1  - kg 76,24/ m³ 0,889</p>	<p><b>Art.5227</b> COL requirement m² 13.42 H 140 cm. COM Meterage m 6.64 *Classe 1, 2, 11M: fire retardant version available with surcharge and eventual minimum batch</p> <p><b>Art.5228</b> COL requirement m² 12.38 H 140 cm. COM Meterage m 5.7 *Classe 1, 2, 11M: fire retardant version available with surcharge and eventual minimum batch</p> <p><b>Art.5229</b> COL requirement m² 12.92 H 140 cm. COM Meterage m 6.09 *Classe 1, 2, 11M: fire retardant version available with surcharge and eventual minimum batch</p> <p><b>Art.5230</b> COL requirement m² 12.92 H 140 cm. COM Meterage m 6.09 *Classe 1, 2, 11M: fire retardant version available with surcharge and eventual minimum batch</p>	



# Steeve Wooden Frame

Design by Jean-Marie Massaud, 2015

<b>SEK ART. 5227</b>	A	B COM	C COL	D	E	F	G	H	I	J	K	L	M	ES
External side wood + inside upholstered with a single material in just one color	47069	49367	51665	53963	56261	58559	60857	63155	65453	67751	70049	72347	74645	83861
<b>SEK ART. 5228</b>	A	B COM	C COL	D	E	F	G	H	I	J	K	L	M	ES
External side wood + inside upholstered with a single material in just one color	36174	38186	40198	42210	44222	46234	48246	50258	52270	54282	56294	58306	60318	68466
<b>SEK ART. 5229</b>	A	B COM	C COL	D	E	F	G	H	I	J	K	L	M	ES
External side wood + inside upholstered with a single material in just one color	41555	43674	45793	47912	50031	52150	54269	56388	58507	60626	62745	64864	66983	75538
<b>SEK ART. 5230</b>	A	B COM	C COL	D	E	F	G	H	I	J	K	L	M	ES
External side wood + inside upholstered with a single material in just one color	41555	43674	45793	47912	50031	52150	54269	56388	58507	60626	62745	64864	66983	75538
<b>FIRE RETARDANT TEST</b>														
Classe 1IM Omologazione Italia Coated fabric Valencia Spradling. * FIRE RETARDANT VERSION WITH SURCHARGE * Classe 1IM Omologazione Italia Remix 3 Kvadrat.														

Frame Base



V44  
matt

Top



L0006 L0022 L0028



# Steeve Wooden Frame





Design by Jean-Marie Massaud, 2015

Three seat sofa available in the following versions: with or without armrests, with right or left armrest. Frame with reconstituted veneer on the external side and with fabric, leather or coated fabric on the inside. The seat and backrest cushions have the same upholstery as the frame internal side.

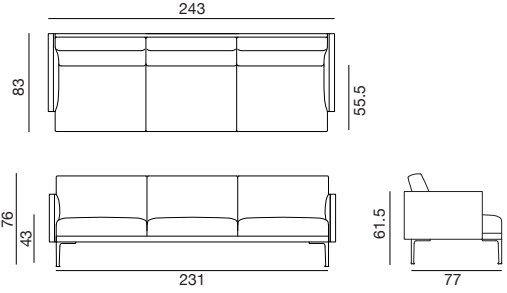
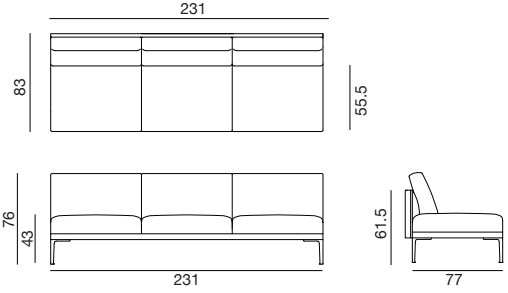
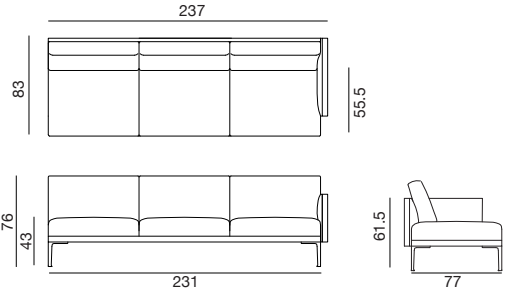
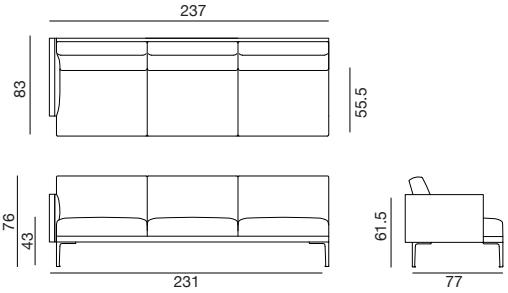
Accessories:  
Link Kit Art. 5315



 <p><b>ART. 5243</b></p>	 <p><b>ART. 5244</b></p>
 <p><b>ART. 5245</b></p>	 <p><b>ART. 5246</b></p>

SHIPMENT DETAILS	TECHNICAL SPECIFICATIONS	RESISTANCE TEST
<p><b>Art. 5243</b> 1 pz = 1  - kg 114,9/ m³ 1,27</p> <p><b>Art. 5244</b> 1 pz = 1  - kg 98,18/ m³ 1,27</p> <p><b>Art. 5245</b> 1 pz = 1  - kg 106,5/ m³ 1,27</p> <p><b>Art. 5246</b> 1 pz = 1  - kg 106,5/ m³ 1,27</p>	<p><b>Art.5243</b> COL requirement m² 20.1 H 140 cm. COM Meterage m 9.2 *Classe 1, 2, 11M: fire retardant version available with surcharge and eventual minimum batch</p> <p><b>Art.5244</b> COL requirement m² 17.13 H 140 cm. COM Meterage m 8.33 *Classe 1, 2, 11M: fire retardant version available with surcharge and eventual minimum batch</p> <p><b>Art.5245</b> COL requirement m² 19.07 H 140 cm. COM Meterage m 8.79 *Classe 1, 2, 11M: fire retardant version available with surcharge and eventual minimum batch</p> <p><b>Art.5246</b> COL requirement m² 19.07 H 140 cm. COM Meterage m 8.79 *Classe 1, 2, 11M: fire retardant version available with surcharge and eventual minimum batch</p>	



# Steeve Wooden Frame

Design by Jean-Marie Massaud, 2015

<b>SEK ART. 5243</b>	A	B COM	C COL	D	E	F	G	H	I	J	K	L	M	ES
External side wood + inside upholstered with a single material in just one color	59774	62954	66134	69314	72494	75674	78854	82034	85214	88394	91574	94754	97934	110711
<b>SEK ART. 5244</b>	A	B COM	C COL	D	E	F	G	H	I	J	K	L	M	ES
External side wood + inside upholstered with a single material in just one color	48794	51711	54628	57545	60462	63379	66296	69213	72130	75047	77964	80881	83798	95470
<b>SEK ART. 5245</b>	A	B COM	C COL	D	E	F	G	H	I	J	K	L	M	ES
External side wood + inside upholstered with a single material in just one color	54332	57285	60238	63191	66144	69097	72050	75003	77956	80909	83862	86815	89768	101495
<b>SEK ART. 5246</b>	A	B COM	C COL	D	E	F	G	H	I	J	K	L	M	ES
External side wood + inside upholstered with a single material in just one color	54332	57285	60238	63191	66144	69097	72050	75003	77956	80909	83862	86815	89768	101495
<b>FIRE RETARDANT TEST</b>														
Classe 1IM Omologazione Italia Coated fabric Valencia Spradling. * FIRE RETARDANT VERSION WITH SURCHARGE * Classe 1IM Omologazione Italia Remix 3 Kvadrat.														

Frame Base



V44  
matt

Top



L0006 L0022 L0028





# Steeve Wooden Frame

Design by Jean-Marie Massaud, 2015

Right or left 90° corner components, already equipped with seat links. Frame with reconstituted veneer on the external side and with fabric, leather or coated fabric on the inside. The seat and backrest cushions have the same upholstery as the frame internal side.

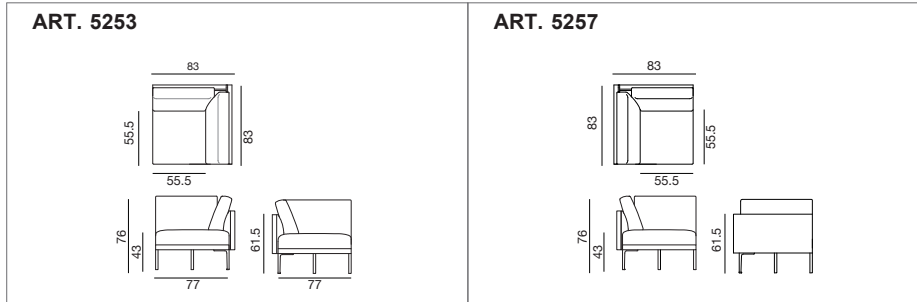

SEK ART. 5253	A	B COM	C COL	D	E	F	G	H	I	J	K	L	M	ES
External side wood + inside upholstered with a single material in just one color	28624	30160	31696	33232	34768	36304	37840	39376	40912	42448	43984	45520	47056	53141
SEK ART. 5257	A	B COM	C COL	D	E	F	G	H	I	J	K	L	M	ES
External side wood + inside upholstered with a single material in just one color	28624	30160	31696	33232	34768	36304	37840	39376	40912	42448	43984	45520	47056	53141

SHIPMENT DETAILS	TECHNICAL SPECIFICATIONS	RESISTANCE TEST
<b>Art. 5253</b> 1 pz = 1  - kg 53,18/ m³ 0,508 <b>Art. 5257</b> 1 pz = 1  - kg 53,18/ m³ 0,508	<b>Art.5253</b> COL requirement m² 7.12 H 140 cm. COM Meterage m 4.43 *Classe 1, 2, 11M: fire retardant version available with surcharge and eventual minimum batch <b>Art.5257</b> COL requirement m² 7.12 H 140 cm. COM Meterage m 4.43 *Classe 1, 2, 11M: fire retardant version available with surcharge and eventual minimum batch	
Classe 11M Omologazione Italia Coated fabric Valencia Spradling. • FIRE RETARDANT VERSION WITH SURCHARGE * Classe 11M Omologazione Italia Remix 3 Kvadrat.		

Frame Base



Shell

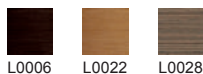

# Steeve

Design by Jean-Marie Massaud, 2015

Two or three seat bench with one material one color upholstery available with fabric, leather or coated fabric.

Accessories:  
Link Kit Art. 5315



SEK ART. 5201	A	B COM	C COL	D	E	F	G	H	I	J	K	L	M	ES
Entirely upholstered with a single material in just one color	20087	21253	22419	23585	24751	25917	27083	28249	29415	30581	31747	32913	34079	38721

SEK ART. 5202	A	B COM	C COL	D	E	F	G	H	I	J	K	L	M	ES
Entirely upholstered with a single material in just one color	25755	27362	28969	30576	32183	33790	35397	37004	38611	40218	41825	43432	45039	51689

SHIPMENT DETAILS	TECHNICAL SPECIFICATIONS	RESISTANCE TEST
<b>Art. 5201</b> 1 pz = 1  - kg 45,18/ m² 0,889 <b>Art. 5202</b> 1 pz = 1  - kg 64,13/ m² 1,27	<b>Art.5201</b> COL requirement m² 6.8 H 140 cm. COM Meterage m 3.54 *Classe 1, 2, 1IM: fire retardant version available with surcharge and eventual minimum batch  <b>Art.5202</b> COL requirement m² 9.13 H 140 cm. COM Meterage m 4.83 *Classe 1, 2, 1IM: fire retardant version available with surcharge and eventual minimum batch Contact us for upholstered with a single material in different color.	

Frame Base



# Steeve

Design by Jean-Marie Massaud, 2015

Different sizes of cushions. The upholstery is made from down and fiber, available in leather, customer's leather, coated fabric, fabric or customer's fabric.

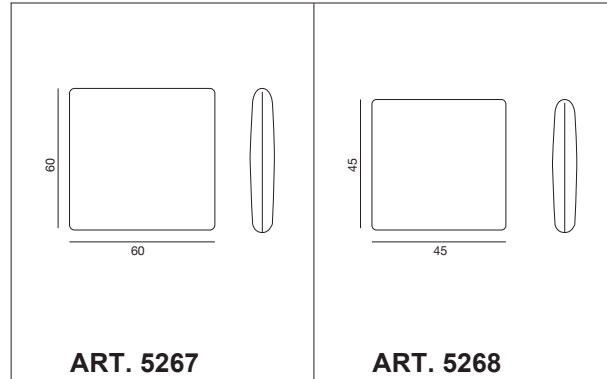

<b>SEK ART. 5267</b>	A	B COM	C COL	D	E	F	G	H	I	J	K	L	M	ES
Cushion 60 x 60 cm	2012	2238	2464	2690	2916	3142	3368	3594	3820	4046	4272	4498	4724	5787
<b>SEK ART. 5268</b>	A	B COM	C COL	D	E	F	G	H	I	J	K	L	M	ES
Cushion 45 x 45 cm	1560	1726	1892	2058	2224	2390	2556	2722	2888	3054	3220	3386	3552	4393

SHIPMENT DETAILS	TECHNICAL SPECIFICATIONS	RESISTANCE TEST
<b>Art. 5267</b> 1 pz = 1  - kg 2,9/ m² 0,13 <b>Art. 5268</b> 1 pz = 1  - kg 4,6/ m² 0,075	<b>Art.5267</b> COL requirement m² 1.18 H 140 cm. COM Meterage m 0.72 <b>Art.5268</b> COL requirement m² 0.91 H 140 cm. COM Meterage m 0.55	
<b>FIRE RETARDANT TEST</b>		

# Accessories

Design by Jean-Marie Massaud

## SEK ART. 5315

Link kit for linear modules

751

## ART. 5315

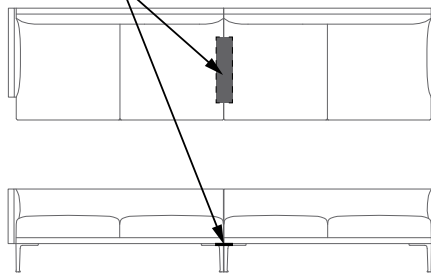

SHIPMENT DETAILS	TECHNICAL SPECIFICATIONS	RESISTANCE TEST
<b>Art. 5315</b> 1 pz = 1  - kg 1,85/ m³ 0,004		
<b>FIRE RETARDANT TEST</b>		





# ZINTA

Design by  
Lievore Altherr Molina  
2014

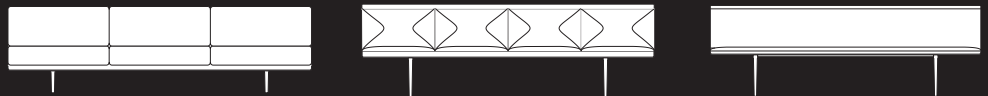

# Zinta

## Collection overview

### Zinta Lounge

#### Cushions available



- Exposed backrest
- Single seat cushion



- Multi backrest cushions
- Single seat cushion



- Multi backrest cushions
- Multi seat cushions

Right and/or left armrest version  
For Art. 4401 and 4419: armrest not available



### Modular

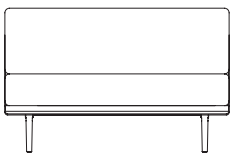

120 cm

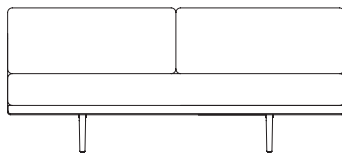

180 cm

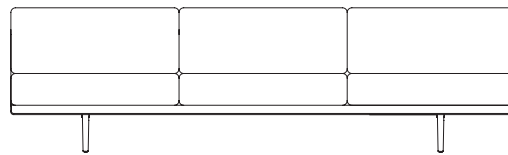

270 cm

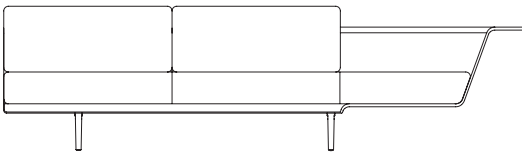

90° dx

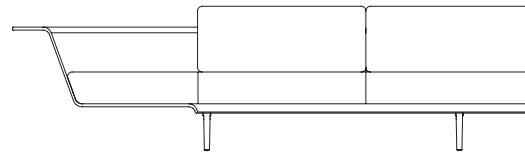

90° sx

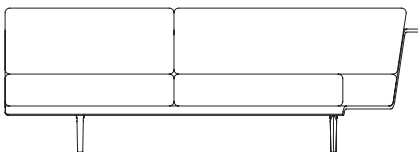

135° dx

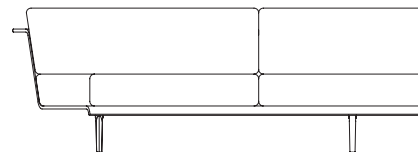

135° sx

# Zinta

## Zinta Waiting

### Cushions available

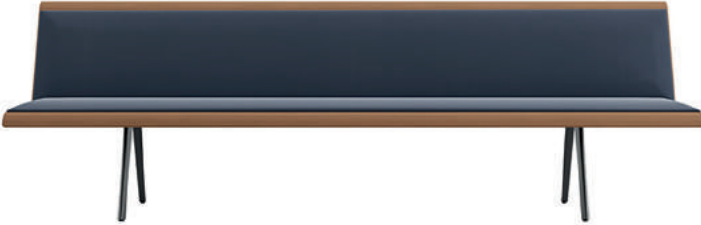

- Single backrest cushion
- Single seat cushion



- Multi backrest cushions
- Multi seat cushions

Armrest available  
for multi cushions  
version



## Modular

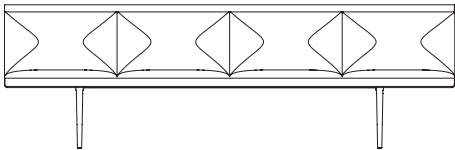

240 cm

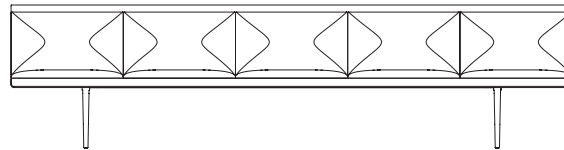

300 cm

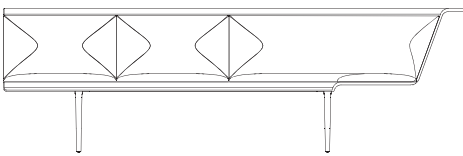

90° dx

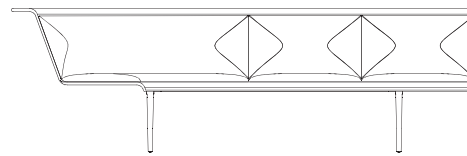

90° sx

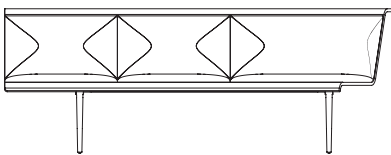

135° dx

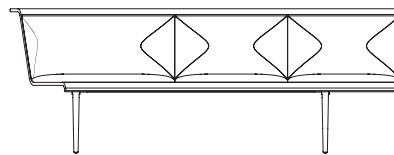

135° sx



# Zinta

## Zinta Eating

Cushions available



— Exposed backrest and seat

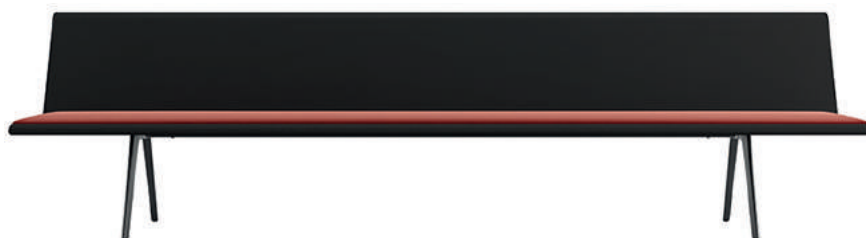

— Exposed backrest  
— Single seat cushion

## Modular

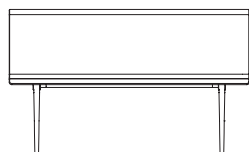

140 cm



240 cm

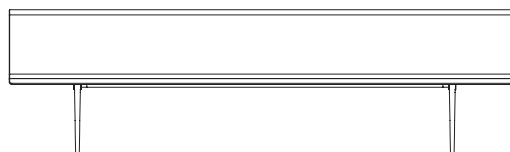

300 cm

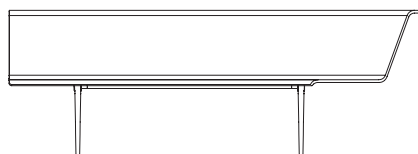

90° dx

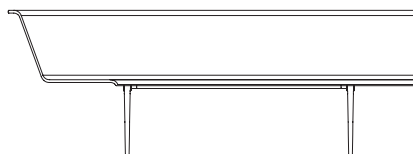

90° sx

**Zinta Lounge**

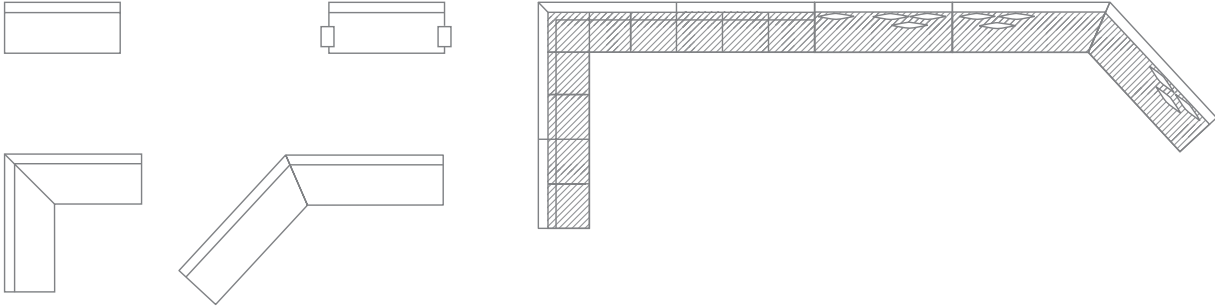

**Zinta Waiting**

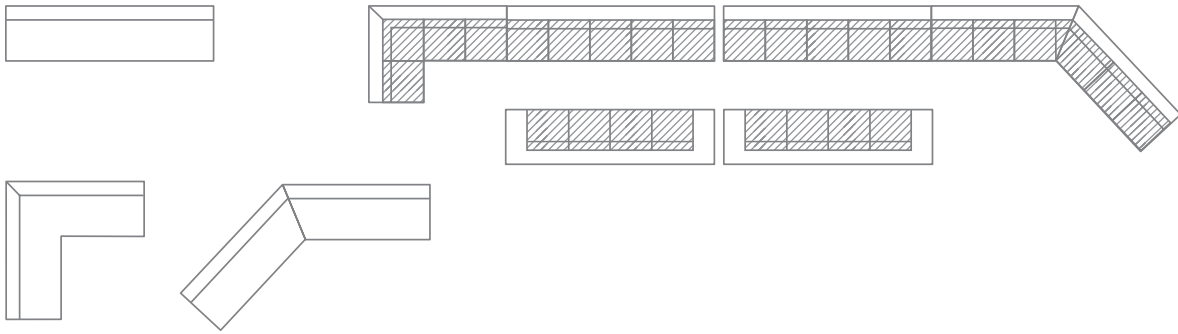

**Zinta Eating**

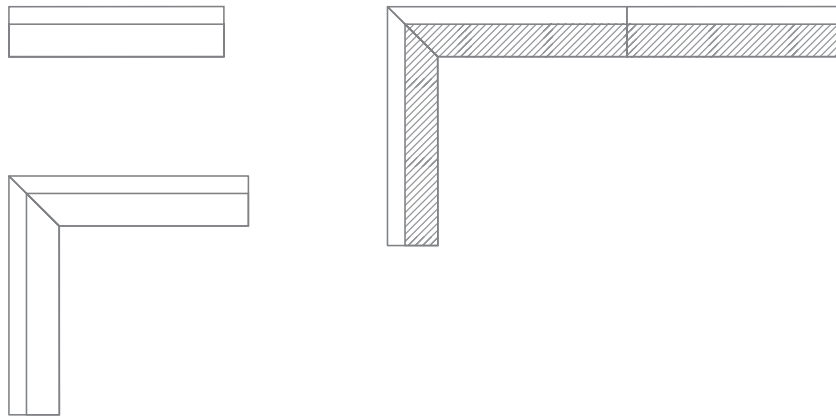

# Zinta Lounge Wood

Design by Lievore Altherr Molina, 2014



Modular seat components with oak veneered plywood frame, available in several colors. Steel frame and aluminum legs both powder-coated in anthracite color. The shell is provided with cushions upholstered in fabric, leather, coated fabric or customer's own material applied on both seat and backrest or only on the seat. The modules can be combined to create linear or L-shaped arrangements (for the articles 4406 - 4407 - 4408 - 4409 the cushion angle must be ordered separately Artt 4417 - 4418). Cushions are available upon request and may be ordered separately. Armrests not available.

Accessories:  
Link Kit Art. 4428

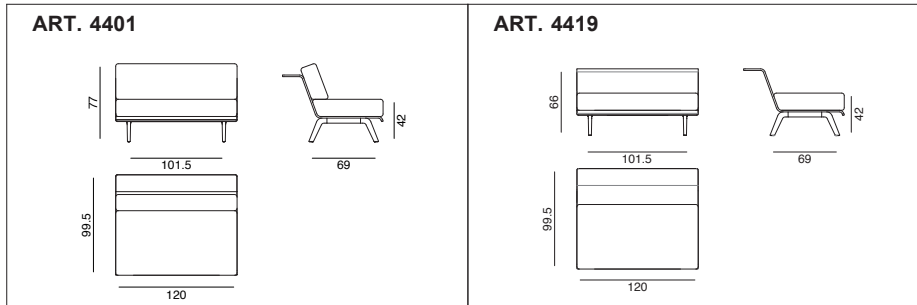

<b>SEK ART. 4401</b>	A	B COM	C COL	D	E	F	G	H	I	J	K	L	M	ES
Bench L1200 - 1 seat cushion & 1 back cushion	33375	34244	35113	35982	36851	37720	38589	39458	40327	41196	42065	42934	43803	47271
<b>SEK ART. 4419</b>	A	B COM	C COL	D	E	F	G	H	I	J	K	L	M	ES
Bench L1200 - 1 seat cushion	31221	32055	32889	33723	34557	35391	36225	37059	37893	38727	39561	40395	41229	44616

SHIPMENT DETAILS	TECHNICAL SPECIFICATIONS	RESISTANCE TEST
<b>Art. 4401</b> 1 pz = 1  - kg 34/ m³ 1,002 <b>Art. 4419</b> 1 pz = 1  - kg 34/ m³ 1,002	<b>Art.4401</b> COL requirement m² 7.03 H 140 cm. COM Meterage m 2.86 <b>Art.4419</b> COL requirement m² 5.07 H 140 cm. COM Meterage m 1.82	
<b>FIRE RETARDANT TEST</b> Classe 11M Omologazione Italia Elmosoft. Remix 3 Kvadrat. Steelcut Trio 3 Kvadrat. Coated fabric Valencia Spradling.		

Frame Base



V44  
matt

Shell



L0006



L0022



L0023



# Zinta Lounge Wood

Design by Lievore Altherr Molina, 2014

Modular seat components with oak veneered plywood frame, available in several colors. Steel frame and aluminum legs both powder-coated in anthracite color. The shell is provided with cushions upholstered in fabric, leather, coated fabric or customer's own material applied on both seat and backrest or only on the seat. The modules can be combined to create linear or L-shaped arrangements (for the articles 4406 - 4407 - 4408 - 4409 the cushion angle must be ordered separately Artt 4417 - 4418). Cushions are available upon request and may be ordered separately.

Accessories:  
 Armrest (right or left) Art. 4416  
 Link Kit Art. 4428

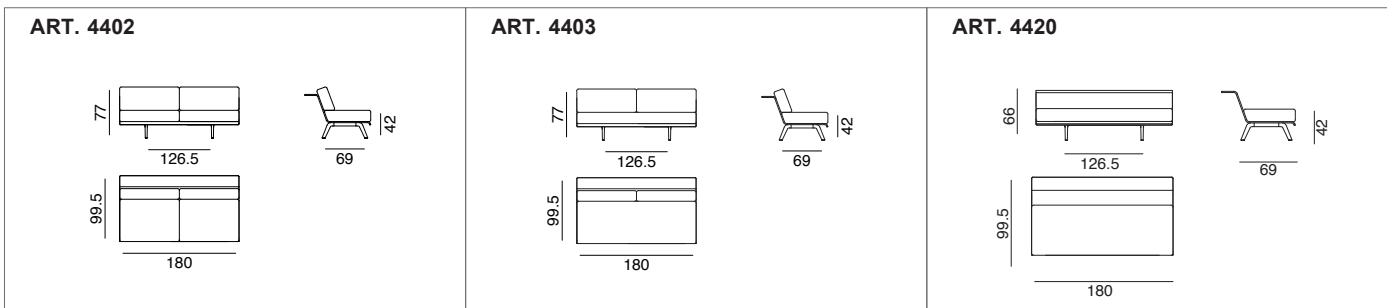

SEK ART. 4402	A	B COM	C COL	D	E	F	G	H	I	J	K	L	M	ES
Bench L 1800 - 2 seat cushions L900 & 2 back cushions L900	45889	47449	49009	50569	52129	53689	55249	56809	58369	59929	61489	63049	64609	71383
SEK ART. 4403	A	B COM	C COL	D	E	F	G	H	I	J	K	L	M	ES
Bench L1800 - 1 seat cushion & 2 back cushions L900	44996	46294	47592	48890	50188	51486	52784	54082	55380	56678	57976	59274	60572	65857
SEK ART. 4420	A	B COM	C COL	D	E	F	G	H	I	J	K	L	M	ES
Bench L1800 - 1 seat cushion	40341	41353	42365	43377	44389	45401	46413	47425	48437	49449	50461	51473	52485	56832

SHIPMENT DETAILS	TECHNICAL SPECIFICATIONS	RESISTANCE TEST
<b>Art. 4402</b> 1 pz = 1  - kg 48/ m³ 1,415 <b>Art. 4403</b> 1 pz = 1  - kg 48/ m³ 1,415 <b>Art. 4420</b> 1 pz = 1  - kg 46/ m³ 1,415	<b>Art.4402</b> COL requirement m² 13.02 H 140 cm. COM Meterage m 5.06 <b>Art.4403</b> COL requirement m² 12.52 H 140 cm. COM Meterage m 4.6 <b>Art.4420</b> COL requirement m² 6.27 H 140 cm. COM Meterage m 2.48	<ul style="list-style-type: none"> <li>• EN 1728:2012 - EN 16139:2013 6.10</li> <li>• EN 1728:2012 - EN 16139:2013 6.15</li> <li>• EN 1728:2012 - EN 16139:2013 6.17</li> <li>• EN 1728:2012 - EN 16139:2013 6.20</li> <li>• EN 1728:2012 - EN 16139:2013 6.25</li> <li>• EN 1728:2012 - EN 16139:2013 6.4</li> </ul> <ul style="list-style-type: none"> <li>• EN 1728:2012 - EN 16139:2013 6.11</li> <li>• EN 1728:2012 - EN 16139:2013 6.16</li> <li>• EN 1728:2012 - EN 16139:2013 6.18</li> <li>• EN 1728:2012 - EN 16139:2013 6.24</li> <li>• EN 1728:2012 - EN 16139:2013 6.26</li> <li>• EN 1728:2012 - EN 16139:2013 6.5</li> </ul>

Classe 11M Omologazione Italia Elmosoft. Remix 3 Kvadrat. Steelcut Trio 3 Kvadrat. Coated fabric Valencia Spradling.

Frame Base



V44  
 matt

Shell



L0006



L0022



L0023



# Zinta Lounge Wood

Design by Lievore Altherr Molina, 2014

Modular seat components with oak veneered plywood frame, available in several colors. Steel frame and aluminum legs both powder-coated in anthracite color. The shell is provided with cushions upholstered in fabric, leather, coated fabric or customer's own material applied on both seat and backrest or only on the seat. The modules can be combined to create linear or L-shaped arrangements (for the articles 4406 - 4407 - 4408 - 4409 the cushion angle must be ordered separately Artt 4417 - 4418). Cushions are available upon request and may be ordered separately.

Accessories:  
Armrest (right or left) Art. 4416  
Link Kit Art. 4428

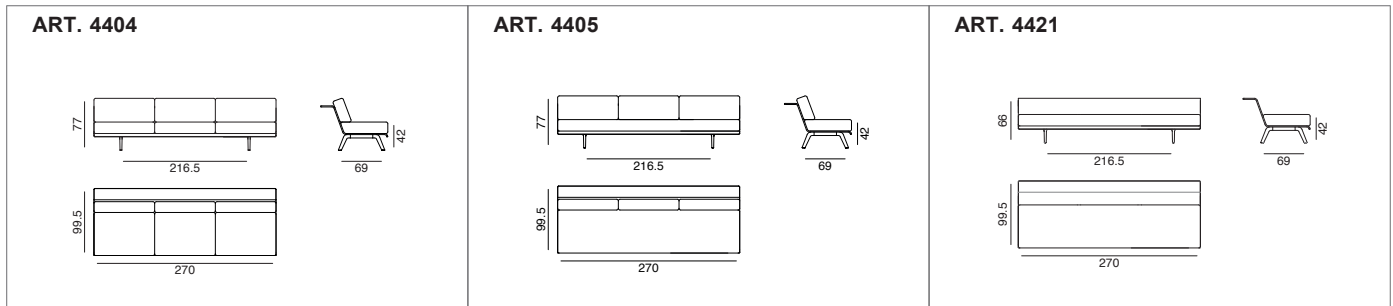

SEK ART. 4404	A	B COM	C COL	D	E	F	G	H	I	J	K	L	M	ES
Bench L2700 - 3 seat cushions L900 & 3 back cushions L900	64572	66942	69312	71682	74052	76422	78792	81162	83532	85902	88272	90642	93012	102948
SEK ART. 4405	A	B COM	C COL	D	E	F	G	H	I	J	K	L	M	ES
Bench L2700 - 1 seat cushion & 3 back cushions L900	62381	64250	66119	67988	69857	71726	73595	75464	77333	79202	81071	82940	84809	92481
SEK ART. 4421	A	B COM	C COL	D	E	F	G	H	I	J	K	L	M	ES
Bench L2700 - 1 seat cushion	55130	56428	57726	59024	60322	61620	62918	64216	65514	66812	68110	69408	70706	75991

SHIPMENT DETAILS	TECHNICAL SPECIFICATIONS	RESISTANCE TEST
<b>Art. 4404</b> 1 pz = 1  - kg 68/ m² 2,035 <b>Art. 4405</b> 1 pz = 1  - kg 68/ m² 2,035 <b>Art. 4421</b> 1 pz = 1  - kg 65/ m² 2,035	<b>Art.4404</b> COL requirement m² 19,53 H 140 cm. COM Meterage m 7.59 <b>Art.4405</b> COL requirement m² 15,05 H 140 cm. COM Meterage m 6.58 <b>Art.4421</b> COL requirement m² 7.56 H 140 cm. COM Meterage m 3.47	

Classe 11M Omologazione Italia Elmosoft. Remix 3 Kvadrat. Steelcut Trio 3 Kvadrat. Coated fabric Valencia Spradling.

Frame Base



Shell

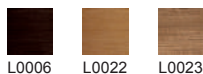

# Zinta Lounge Wood

Design by Lievore Altherr Molina, 2014

Modular seat components with oak veneered plywood frame, available in several colors. Steel frame and aluminum legs both powder-coated in anthracite color. The shell is provided with cushions upholstered in fabric, leather, coated fabric or customer's own material applied on both seat and backrest or only on the seat. The modules can be combined to create linear or L-shaped arrangements (for the articles 4406 - 4407 - 4408 - 4409 the cushion angle must be ordered separately Artt 4417 - 4418). Cushions are available upon request and may be ordered separately.

Accessories:

Armrest (right or left) Art. 4416

Seat cushion angle 90° Art. 4417

Backrest cushion angle 90° Art. 4418

Link Kit Art. 4428

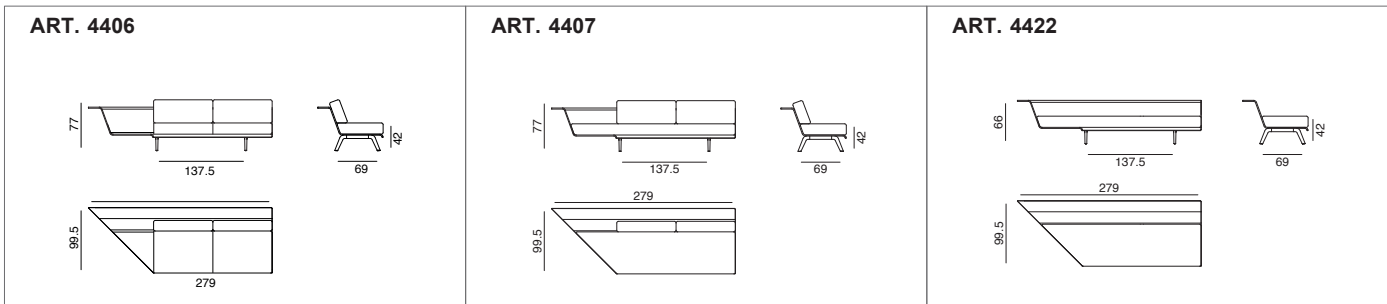

SEK ART. 4406	A	B COM	C COL	D	E	F	G	H	I	J	K	L	M	ES
2 seater, 90° right angular bench - 2 seat cushions L900 & 2 back cushions L900	65703	67513	69323	71133	72943	74753	76563	78373	80183	81993	83803	85613	87423	94566
SEK ART. 4407	A	B COM	C COL	D	E	F	G	H	I	J	K	L	M	ES
2 seater, 90° right angular bench - 1 seat cushion & 2 back cushions L900	66655	68310	69965	71620	73275	74930	76585	78240	79895	81550	83205	84860	86515	93744
SEK ART. 4422	A	B COM	C COL	D	E	F	G	H	I	J	K	L	M	ES
2 seater, 90° right angular bench - 1 seat cushion	61333	62548	63763	64978	66193	67408	68623	69838	71053	72268	73483	74698	75913	81193

SHIPMENT DETAILS	TECHNICAL SPECIFICATIONS	RESISTANCE TEST
<b>Art. 4406</b> 1 pz = 1  - kg 55/ m³ 2,104 <b>Art. 4407</b> 1 pz = 1  - kg 55/ m³ 2,104 <b>Art. 4422</b> 1 pz = 1  - kg 54/ m³ 2,104	<b>Art.4406</b> COL requirement m² 13.02 H 140 cm. COM Meterage m 5.06 <b>Art.4407</b> COL requirement m² 12.63 H 140 cm. COM Meterage m 5.28 <b>Art.4422</b> COL requirement m² 7 H 140 cm. COM Meterage m 3.3	

Classe 11M Omologazione Italia Elmosoft. Remix 3 Kvadrat. Steelcut Trio 3 Kvadrat. Coated fabric Valencia Spradling.

Frame Base



V44  
matt

Shell



L0006



L0022



L0023



# Zinta Lounge Wood

Design by Lievore Altherr Molina, 2014

Modular seat components with oak veneered plywood frame, available in several colors. Steel frame and aluminum legs both powder-coated in anthracite color. The shell is provided with cushions upholstered in fabric, leather, coated fabric or customer's own material applied on both seat and backrest or only on the seat. The modules can be combined to create linear or L-shaped arrangements (for the articles 4406 - 4407 - 4408 - 4409 the cushion angle must be ordered separately Artt 4417 - 4418). Cushions are available upon request and may be ordered separately.

Accessories:  
 Armrest (right or left) Art. 4416  
 Seat cushion angle 90° Art. 4417  
 Backrest cushion angle 90° Art. 4418  
 Link Kit Art. 4428

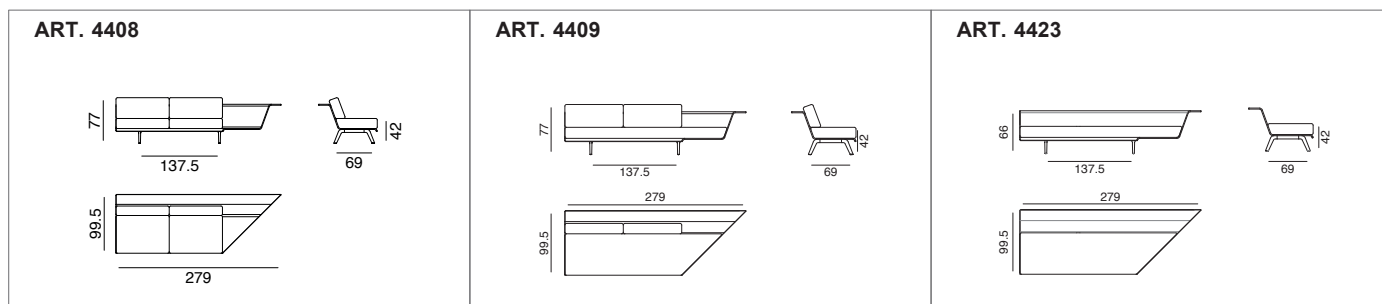

SEK ART. 4408	A	B COM	C COL	D	E	F	G	H	I	J	K	L	M	ES
2 seater, 90° left angular bench - 2 seat cushions & 2 back cushions L900	65703	67513	69323	71133	72943	74753	76563	78373	80183	81993	83803	85613	87423	94566
SEK ART. 4409	A	B COM	C COL	D	E	F	G	H	I	J	K	L	M	ES
2 seater, 90° left angular bench - 1 seat cushion & 2 back cushions L900	66655	68310	69965	71620	73275	74930	76585	78240	79895	81550	83205	84860	86515	93744
SEK ART. 4423	A	B COM	C COL	D	E	F	G	H	I	J	K	L	M	ES
2 seater, 90° left angular bench - 1 seat cushion	61333	62548	63763	64978	66193	67408	68623	69838	71053	72268	73483	74698	75913	81193

SHIPMENT DETAILS	TECHNICAL SPECIFICATIONS	RESISTANCE TEST
<b>Art. 4408</b> 1 pz = 1  - kg 55/ m² 2,104 <b>Art. 4409</b> 1 pz = 1  - kg 55/ m² 2,104 <b>Art. 4423</b> 1 pz = 1  - kg 54/ m² 2,104	<b>Art.4408</b> COL requirement m² 13.02 H 140 cm. COM Meterage m 5.06 <b>Art.4409</b> COL requirement m² 12.63 H 140 cm. COM Meterage m 5.28 <b>Art.4423</b> COL requirement m² 7 H 140 cm. COM Meterage m 3.3	
Classe 1IM Omologazione Italia Elmosoft. Remix 3 Kvadrat. Steelcut Trio 3 Kvadrat. Coated fabric Valencia Spradling.		

Frame Base



V44  
matt

Shell



L0006



L0022



L0023



# Zinta Lounge Wood

Design by Lievore Altherr Molina, 2014

Modular seat components with oak veneered plywood frame, available in several colors. Steel frame and aluminum legs both powder-coated in anthracite color. The shell is provided with cushions upholstered in fabric, leather, coated fabric or customer's own material applied on both seat and backrest or only on the seat. The modules can be combined to create linear or L-shaped arrangements (for the articles 4406 - 4407 - 4408 - 4409 the cushion angle must be ordered separately Artt 4417 - 4418). Cushions are available upon request and may be ordered separately.

Accessories:  
Armrest (right or left) Art. 4416  
Link Kit Art. 4428

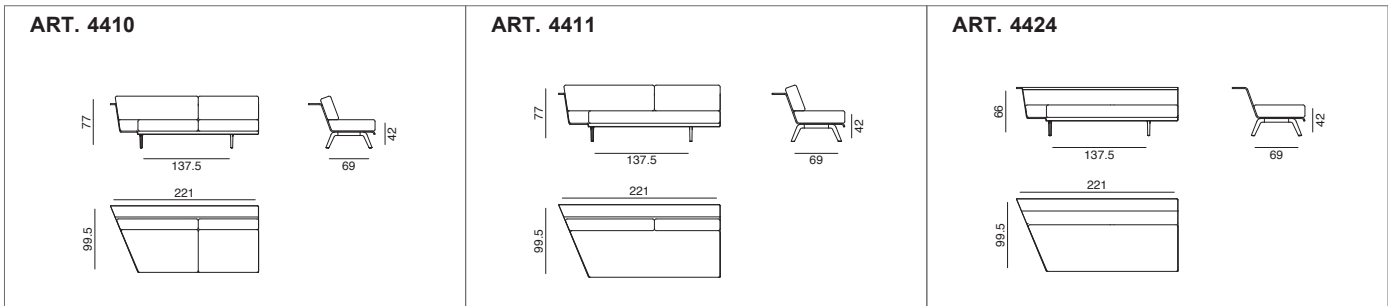

SEK ART. 4410	A	B COM	C COL	D	E	F	G	H	I	J	K	L	M	ES
2 seater, 135° right angular bench - 2 seat & back cushions (L900 + angular)	61786	63560	65334	67108	68882	70656	72430	74204	75978	77752	79526	81300	83074	90100
SEK ART. 4411	A	B COM	C COL	D	E	F	G	H	I	J	K	L	M	ES
2 seater, 135° right angular bench - 1 seat cushion & 2 back cushions (L900 & angular)	61298	62893	64488	66083	67678	69273	70868	72463	74058	75653	77248	78843	80438	87302
SEK ART. 4424	A	B COM	C COL	D	E	F	G	H	I	J	K	L	M	ES
2 seater, 135° right angular bench - 1 seat cushion	55296	56439	57582	58725	59868	61011	62154	63297	64440	65583	66726	67869	69012	73835

SHIPMENT DETAILS	TECHNICAL SPECIFICATIONS	RESISTANCE TEST
<b>Art. 4410</b> 1 pz = 1  - kg 53/ m³ 1,697 <b>Art. 4411</b> 1 pz = 1  - kg 53/ m³ 1,697 <b>Art. 4424</b> 1 pz = 1  - kg 50/ m³ 1,697	<b>Art.4410</b> COL requirement m² 12,66 H 140 cm. COM Meterage m 5.5 <b>Art.4411</b> COL requirement m² 12,7 H 140 cm. COM Meterage m 5.39 <b>Art.4424</b> COL requirement m² 6,22 H 140 cm. COM Meterage m 2,81	

Classe 1IM Omologazione Italia Elmosoft. Remix 3 Kvadrat. Steelcut Trio 3 Kvadrat. Coated fabric Valencia Spradling.

Frame Base



V44  
matt

Shell



L0006



L0022



L0023



arper



# Zinta Lounge Wood

Design by Lievore Altherr Molina, 2014

Modular seat components with oak veneered plywood frame, available in several colors. Steel frame and aluminum legs both powder-coated in anthracite color. The shell is provided with cushions upholstered in fabric, leather, coated fabric or customer's own material applied on both seat and backrest or only on the seat. The modules can be combined to create linear or L-shaped arrangements (for the articles 4406 - 4407 - 4408 - 4409 the cushion angle must be ordered separately Artt 4417 - 4418). Cushions are available upon request and may be ordered separately.

Accessories:  
Armrest (right or left) Art. 4416  
Link Kit Art. 4428

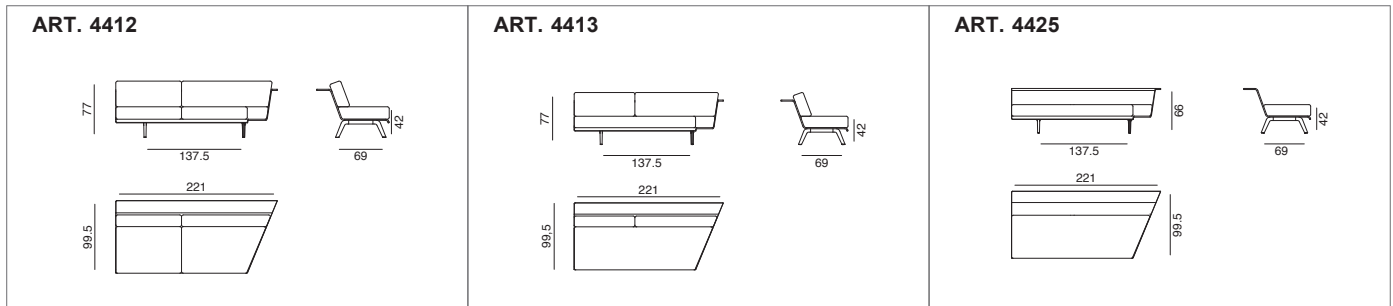

SEK ART. 4412	A	B COM	C COL	D	E	F	G	H	I	J	K	L	M	ES
2 seater, 135° left angular bench – 2 seat & back cushions (L900 + angular)	61786	63560	65334	67108	68882	70656	72430	74204	75978	77752	79526	81300	83074	90100
SEK ART. 4413	A	B COM	C COL	D	E	F	G	H	I	J	K	L	M	ES
2 seater, 135° left angular bench - 1 seat cushion & 2 back cushions (L900 & angular)	61298	62893	64488	66083	67678	69273	70868	72463	74058	75653	77248	78843	80438	87302
SEK ART. 4425	A	B COM	C COL	D	E	F	G	H	I	J	K	L	M	ES
2 seater, 135° right angular bench - 1 seat cushion	55296	56439	57582	58725	59868	61011	62154	63297	64440	65583	66726	67869	69012	73835

SHIPMENT DETAILS	TECHNICAL SPECIFICATIONS	RESISTANCE TEST
<b>Art. 4412</b> 1 pz = 1  - kg 53/ m³ 1,697 <b>Art. 4413</b> 1 pz = 1  - kg 53/ m³ 1,697 <b>Art. 4425</b> 1 pz = 1  - kg 50/ m³ 1,697	<b>Art.4412</b> COL requirement m² 12.66 H 140 cm. COM Meterage m 5.5 <b>Art.4413</b> COL requirement m² 12.7 H 140 cm. COM Meterage m 5.39 <b>Art.4425</b> COL requirement m² 6.22 H 140 cm. COM Meterage m 2.81	

Classe 11M Omologazione Italia Elmosoft. Remix 3 Kvadrat. Steelcut Trio 3 Kvadrat. Coated fabric Valencia Spradling.

Frame Base



Shell

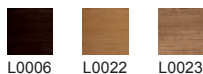

# Accessories

Design by Lievore Altherr Molina, 2014



<b>SEK ART. 4416</b>	WOOD														
Armrest (right or left)	3632														
<b>SEK ART. 4417</b>	A	B COM	C COL	D	E	F	G	H	I	J	K	L	M	ES	
Seat cushion angle 90°	4822	5476	6130	6784	7438	8092	8746	9400	10054	10708	11362	12016	12670	15622	
<b>SEK ART. 4418</b>	A	B COM	C COL	D	E	F	G	H	I	J	K	L	M	ES	
Backrest cushion angle 90°	5846	6394	6942	7490	8038	8586	9134	9682	10230	10778	11326	11874	12422	14586	
<b>SEK ART. 4427</b>	A	B COM	C COL	D	E	F	G	H	I	J	K	L	M	ES	
Only armrest cushion	1715	1929	2143	2357	2571	2785	2999	3213	3427	3641	3855	4069	4283	5334	
<b>SEK ART. 4428</b>	V44														
Link kit for two linear modules Lounge	929														

SHIPMENT DETAILS	TECHNICAL SPECIFICATIONS	RESISTANCE TEST
<b>Art. 4416</b> 1 pz = 1  - kg 2,5/ m³ 0,118  <b>Art. 4427</b> 1 pz = 1  - kg 1/ m³ 0,069	<b>Art.4417</b> COL requirement m² 2.49 H 140 cm. COM Meterage m 2.11  <b>Art.4418</b> COL requirement m² 2.67 H 140 cm. COM Meterage m 1.71  <b>Art.4427</b> COL requirement m² 1.57 H 140 cm. COM Meterage m 1.52	
FIRE RETARDANT TEST		



# Zinta Waiting Wood

Design by Lievore Altherr Molina, 2014



Modular seat components with oak veneered plywood frame available in several colors. Steel frame and aluminum legs lacquered in anthracite color. Shell with upholstered seat and backrest in fabric, customer's material, leather or coated fabric pads placed on the seat and backrest. The modules can be combined to create linear or L-shaped arrangements.

Accessories:  
Link Kit Art. 4570

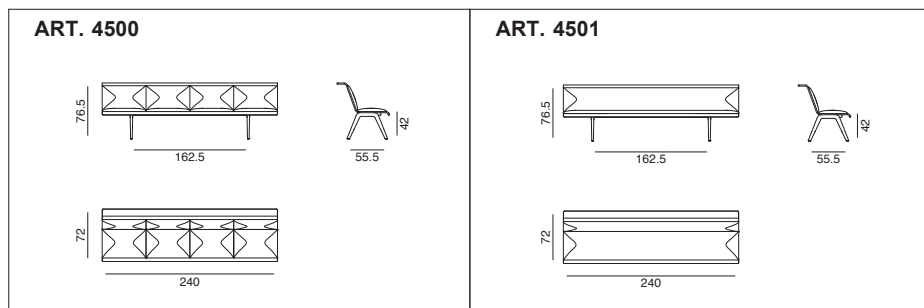

<b>SEK ART. 4500</b>	A	B COM	C COL	D	E	F	G	H	I	J	K	L	M	ES
4 seater bench L2400 - 4 seat pad L600 & 4 back pad L600	52605	53700	54795	55890	56985	58080	59175	60270	61365	62460	63555	64650	65745	70371
<b>SEK ART. 4501</b>	A	B COM	C COL	D	E	F	G	H	I	J	K	L	M	ES
4 seater bench L2400 - 1 seat pad & 1 back pad	47879	48772	49665	50558	51451	52344	53237	54130	55023	55916	56809	57702	58595	62310
Armrest BV for Zinta Waiting - L 240 cm	+ 9037 Art. 4500													

SHIPMENT DETAILS	TECHNICAL SPECIFICATIONS	RESISTANCE TEST
<b>Art. 4500</b> 1 pz = 1  - kg 58/ m³ 0,939 <b>Art. 4501</b> 1 pz = 1  - kg 58/ m³ 0,939	<b>Art.4500</b> COL requirement m² 7.2 H 140 cm. COM Meterage m 3.48 <b>Art.4501</b> COL requirement m² 5.72 H 140 cm. COM Meterage m 2.85	
<b>FIRE RETARDANT TEST</b> Classe 11M Omologazione Italia Elmosoft. Remix 3 Kvadrat. Coated fabric Valencia Spradling.		

Frame Base



V44  
matt

Shell



L0006



L0022



L0023



Armrest BV



# Zinta Waiting Wood

Design by Lievore Altherr Molina, 2014

Modular seat components with oak veneered plywood frame available in several colors. Steel frame and aluminum legs lacquered in anthracite color. Shell with upholstered seat and backrest in fabric, customer's material, leather or coated fabric pads placed on the seat and backrest. The modules can be combined to create linear or L-shaped arrangements.

Accessories:  
Link Kit Art. 4570

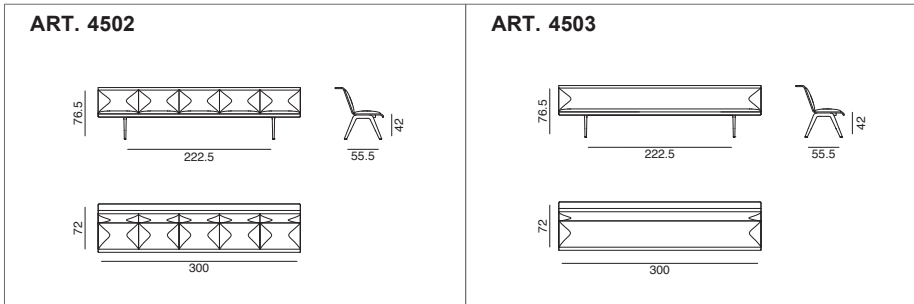

SEK ART. 4502	A	B COM	C COL	D	E	F	G	H	I	J	K	L	M	ES
5 seater bench L3000 - 5 seat pad L600 & 5 back pad	62357	63715	65073	66431	67789	69147	70505	71863	73221	74579	75937	77295	78653	84480
SEK ART. 4503	A	B COM	C COL	D	E	F	G	H	I	J	K	L	M	ES
5 seater bench L3000 - 1 seat pad & 1 back pad	56296	57391	58486	59581	60676	61771	62866	63961	65056	66151	67246	68341	69436	74074
Armrest BV for Zinta Waiting - L 300 cm	+ 12002		Art. 4502											

SHIPMENT DETAILS	TECHNICAL SPECIFICATIONS	RESISTANCE TEST
<b>Art. 4502</b> 1 pz = 1  - kg 72/ m³ 1,153 <b>Art. 4503</b> 1 pz = 1  - kg 72/ m³ 1,153	<b>Art.4502</b> COL requirement m² 9 H 140 cm. COM Meterage m 4.35 <b>Art.4503</b> COL requirement m² 7.42 H 140 cm. COM Meterage m 3.51	<ul style="list-style-type: none"> <li>• EN 1728:2012 - EN 16139:2013 6.15</li> <li>• EN 1728:2012 - EN 16139:2013 6.17</li> <li>• EN 1728:2012 - EN 16139:2013 6.24</li> <li>• EN 1728:2012 - EN 16139:2013 6.4</li> <li>• EN 1728:2012 - EN 16139:2013 6.16</li> <li>• EN 1728:2012 - EN 16139:2013 6.18</li> <li>• EN 1728:2012 - EN 16139:2013 6.25</li> <li>• EN 1728:2012 - EN 16139:2013 6.5</li> </ul>
Classe 1IM Omologazione Italia Elmosoft. Remix 3 Kvadrat. Coated fabric Valencia Spradling.		

Frame Base



Shell

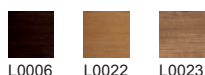

Armrest BV



# Zinta Waiting Wood

Design by Lievore Altherr Molina, 2014

Modular seat components with oak veneered plywood frame available in several colors. Steel frame and aluminum legs lacquered in anthracite color. Shell with upholstered seat and backrest in fabric, customer's material, leather or coated fabric pads placed on the seat and backrest. The modules can be combined to create linear or L-shaped arrangements.

Accessories:  
Link Kit Art. 4570

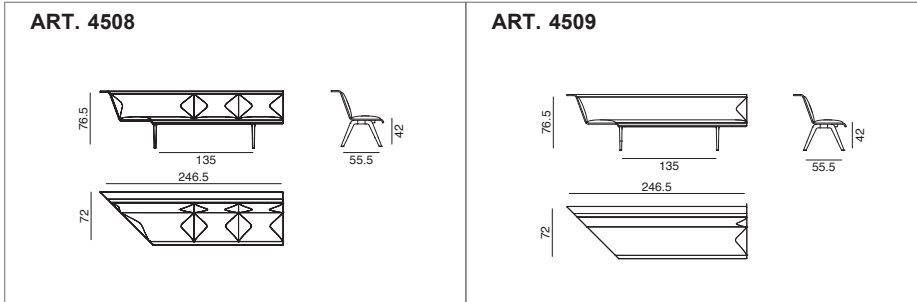

SEK ART. 4508	A	B COM	C COL	D	E	F	G	H	I	J	K	L	M	ES
3 seater, 90° right angular bench - 3 seat pad & 3 back pad	52998	53832	54666	55500	56334	57168	58002	58836	59670	60504	61338	62172	63006	66369
SEK ART. 4509	A	B COM	C COL	D	E	F	G	H	I	J	K	L	M	ES
3 seater, 90° right angular bench - 1 seat pad & 1 back pad	53093	53974	54855	55736	56617	57498	58379	59260	60141	61022	61903	62784	63665	67274

SHIPMENT DETAILS	TECHNICAL SPECIFICATIONS	RESISTANCE TEST
<b>Art. 4508</b> 1 pz = 1  - kg 47/ m³ 0,964 <b>Art. 4509</b> 1 pz = 1  - kg 47/ m³ 0,964	<b>Art.4508</b> COL requirement m² 5.4 H 140 cm. COM Meterage m 2.61 <b>Art.4509</b> COL requirement m² 5.47 H 140 cm. COM Meterage m 2.77	

Classe 11M Omologazione Italia Elmosoft. Remix 3 Kvadrat. Coated fabric Valencia Spradling.

Frame Base



V44  
matt

Shell



L0006



L0022



L0023



# Zinta Waiting Wood

Design by Lievore Altherr Molina, 2014

Modular seat components with oak veneered plywood frame available in several colors. Steel frame and aluminum legs lacquered in anthracite color. Shell with upholstered seat and backrest in fabric, customer's material, leather or coated fabric pads placed on the seat and backrest. The modules can be combined to create linear or L-shaped arrangements.

Accessories:  
Link Kit Art. 4570

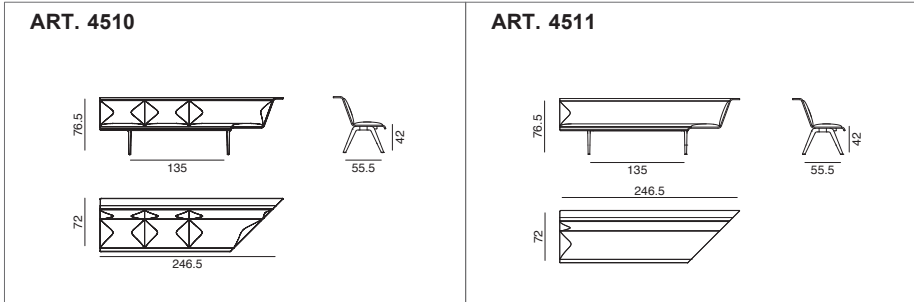

SEK ART. 4510	A	B COM	C COL	D	E	F	G	H	I	J	K	L	M	ES
3 seater, 90° left angular bench - 3 seat pad & 3 back pad	52998	53832	54666	55500	56334	57168	58002	58836	59670	60504	61338	62172	63006	66369
SEK ART. 4511	A	B COM	C COL	D	E	F	G	H	I	J	K	L	M	ES
3 seater, 90° left angular bench - 1 seat pad & 1 back pad	53093	53974	54855	55736	56617	57498	58379	59260	60141	61022	61903	62784	63665	67274

SHIPMENT DETAILS	TECHNICAL SPECIFICATIONS	RESISTANCE TEST
<b>Art. 4510</b> 1 pz = 1  - kg 47/ m² 0,964 <b>Art. 4511</b> 1 pz = 1  - kg 47/ m² 0,964	<b>Art.4510</b> COL requirement m² 5.4 H 140 cm. COM Meterage m 2.61 <b>Art.4511</b> COL requirement m² 5.47 H 140 cm. COM Meterage m 2.77	
Classe 1IM Omologazione Italia Elmosoft. Remix 3 Kvadrat. Coated fabric Valencia Spradling.		

Frame Base



Shell

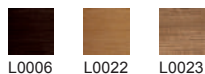

# Zinta Waiting Wood

Design by Lievore Altherr Molina, 2014

Modular seat components with oak veneered plywood frame available in several colors. Steel frame and aluminum legs lacquered in anthracite color. Shell with upholstered seat and backrest in fabric, customer's material, leather or coated fabric pads placed on the seat and backrest. The modules can be combined to create linear or L-shaped arrangements.

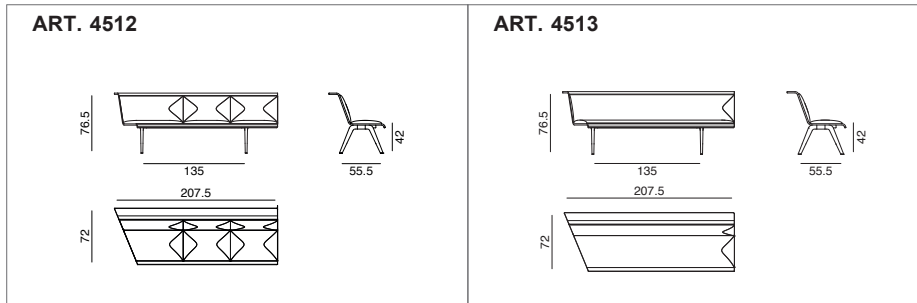

SEK ART. 4512	A	B COM	C COL	D	E	F	G	H	I	J	K	L	M	ES
3 seater, 135° right angular bench - 3 seat pad & 3 back pad	48806	49640	50474	51308	52142	52976	53810	54644	55478	56312	57146	57980	58814	62203
SEK ART. 4513	A	B COM	C COL	D	E	F	G	H	I	J	K	L	M	ES
3 seater, 135° right angular bench - 1 seat pad & 1 back pad	48497	49271	50045	50819	51593	52367	53141	53915	54689	55463	56237	57011	57785	60869

SHIPMENT DETAILS	TECHNICAL SPECIFICATIONS	RESISTANCE TEST
<b>Art. 4512</b> 1 pz = 1  - kg 47/ m³ 0,825 <b>Art. 4513</b> 1 pz = 1  - kg 47/ m³ 0,825	<b>Art.4512</b> COL requirement m² 5.4 H 140 cm. COM Meterage m 2.61 <b>Art.4513</b> COL requirement m² 5.29 H 140 cm. COM Meterage m 2.43	
Classe 11M Omologazione Italia Elmosoft. Remix 3 Kvadrat. Coated fabric Valencia Spradling.		

Frame Base



V44  
matt

Shell



L0006



L0022



L0023



# Zinta Waiting Wood

Design by Lievore Altherr Molina, 2014

Modular seat components with oak veneered plywood frame available in several colors. Steel frame and aluminum legs lacquered in anthracite color. Shell with upholstered seat and backrest in fabric, customer's material, leather or coated fabric pads placed on the seat and backrest. The modules can be combined to create linear or L-shaped arrangements.

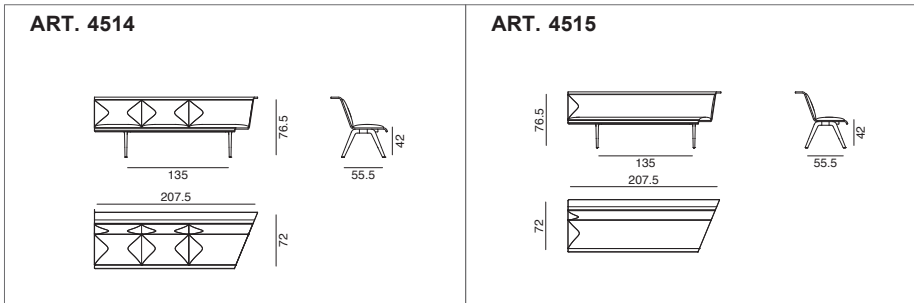

SEK ART. 4514	A	B COM	C COL	D	E	F	G	H	I	J	K	L	M	ES
3 seater, 135° left angular bench - 3 seat pad & 3 back pad	48806	49640	50474	51308	52142	52976	53810	54644	55478	56312	57146	57980	58814	62203
SEK ART. 4515	A	B COM	C COL	D	E	F	G	H	I	J	K	L	M	ES
3 seater, 135° left angular bench - 1 seat pad & 1 back pad	48497	49271	50045	50819	51593	52367	53141	53915	54689	55463	56237	57011	57785	60869

SHIPMENT DETAILS	TECHNICAL SPECIFICATIONS	RESISTANCE TEST
<b>Art. 4514</b> 1 pz = 1  - kg 47/ m³ 0,825 <b>Art. 4515</b> 1 pz = 1  - kg 47/ m³ 0,825	<b>Art.4514</b> COL requirement m² 5.4 H 140 cm. COM Meterage m 2.61 <b>Art.4515</b> COL requirement m² 5.29 H 140 cm. COM Meterage m 2.43	
Classe 1IM Omologazione Italia Elmosoft. Remix 3 Kvadrat. Coated fabric Valencia Spradling.		

Frame Base



V44  
matt

Shell



L0006



L0022



L0023





# Zinta Waiting Laminate

Design by Lievore Altherr Molina, 2014

Modular seat components with laminate shell. Steel frame and aluminum legs lacquered in anthracite color. Shell with upholstered seat and backrest in fabric, customer's material, leather or coated fabric pads placed on the seat and backrest. The modules can be combined to create linear or L-shaped arrangements.

Accessories:  
Link Kit Art. 4570

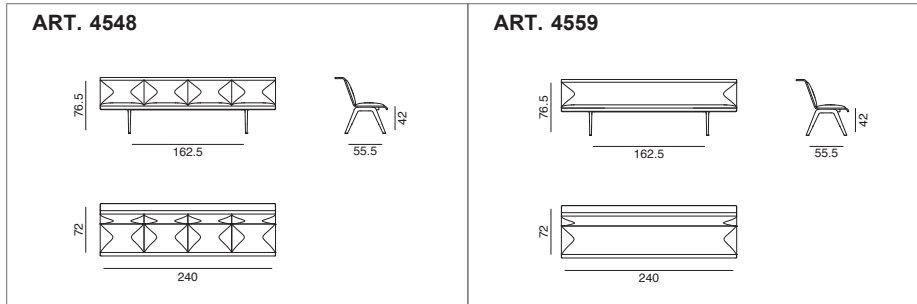

SEK ART. 4548	A	B COM	C COL	D	E	F	G	H	I	J	K	L	M	ES
4 seater bench L2400 - 4 seat pad L600 & 4 back pad L600	45973	47068	48163	49258	50353	51448	52543	53638	54733	55828	56923	58018	59113	63738
SEK ART. 4559	A	B COM	C COL	D	E	F	G	H	I	J	K	L	M	ES
4 seater bench L2400 - 1 seat pad & 1 back pad	41234	42127	43020	43913	44806	45699	46592	47485	48378	49271	50164	51057	51950	55642

SHIPMENT DETAILS	TECHNICAL SPECIFICATIONS	RESISTANCE TEST
<b>Art. 4548</b> 1 pz = 1  - kg 42/ m² 0,939 <b>Art. 4559</b> 1 pz = 1  - kg 72/ m² 0,939	<b>Art.4548</b> COL requirement m² 7.2 H 140 cm. COM Meterage m 3.48 <b>Art.4559</b> COL requirement m² 5.72 H 140 cm. COM Meterage m 2.85	
Classe 11M Omologazione Italia Elmosoft. Remix 3 Kvadrat. Coated fabric Valencia Spradling.		

Frame Base



Shell



# Zinta Waiting Laminate

Design by Lievore Altherr Molina, 2014

Modular seat components with laminate shell. Steel frame and aluminium legs lacquered in anthracite colour. Shell with upholstered seat and backrest in fabric, customer's material, leather or coated fabric pads placed on the seat and backrest. The modules can be combined to create linear or L-shaped arrangements.

Accessories:  
Link Kit Art. 4570

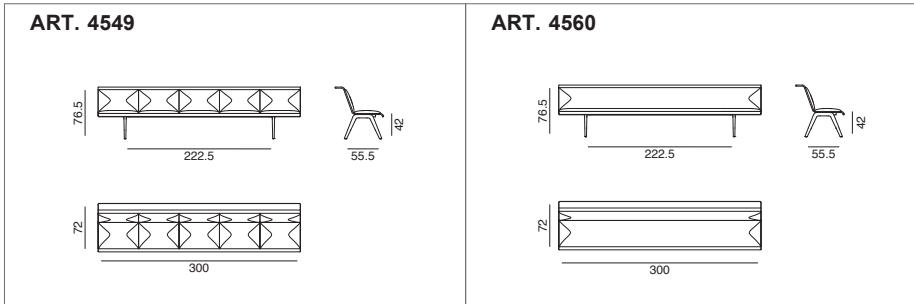

SEK ART. 4549	A	B COM	C COL	D	E	F	G	H	I	J	K	L	M	ES
5 seater bench L3000 - 5 seat pad L600 & 5 back pad	52725	54083	55441	56799	58157	59515	60873	62231	63589	64947	66305	67663	69021	74883
SEK ART. 4560	A	B COM	C COL	D	E	F	G	H	I	J	K	L	M	ES
5 seater bench L3000 - 1 seat pad & 1 back pad	46675	47770	48865	49960	51055	52150	53245	54340	55435	56530	57625	58720	59815	64440

SHIPMENT DETAILS	TECHNICAL SPECIFICATIONS	RESISTANCE TEST
<b>Art. 4549</b> 1 pz = 1  - kg 52/ m³ 1,153 <b>Art. 4560</b> 1 pz = 1  - kg 37/ m³ 1,153	<b>Art.4549</b> COL requirement m² 9 H 140 cm. COM Meterage m 4.35 <b>Art.4560</b> COL requirement m² 7.42 H 140 cm. COM Meterage m 3.51	
Classe 1IM Omologazione Italia Elmosoft. Remix 3 Kvadrat. Coated fabric Valencia Spradling.		

Frame Base



Shell



# Zinta Waiting Laminate

Design by Lievore Altherr Molina, 2014

Modular seat components with laminate shell. Steel frame and aluminium legs lacquered in anthracite colour. Shell with upholstered seat and backrest in fabric, customer's material, leather or coated fabric pads placed on the seat and backrest. The modules can be combined to create linear or L-shaped arrangements.

Accessories:  
Link Kit Art. 4570

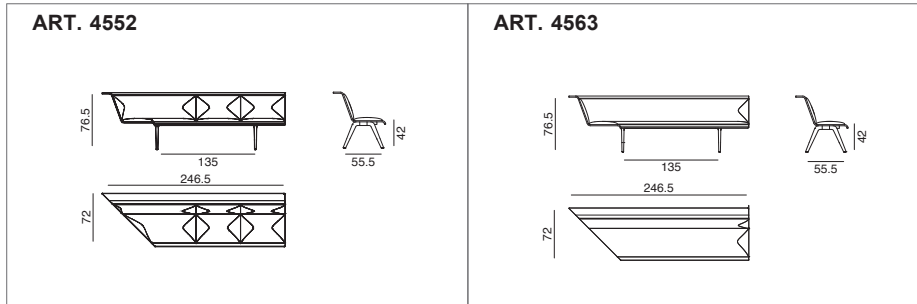

SEK ART. 4552	A	B COM	C COL	D	E	F	G	H	I	J	K	L	M	ES
3 seater, 90° right angular bench - 3 seat pad & 3 back pad	44353	45187	46021	46855	47689	48523	49357	50191	51025	51859	52693	53527	54361	57749
SEK ART. 4563	A	B COM	C COL	D	E	F	G	H	I	J	K	L	M	ES
3 seater, 90° right angular bench - 1 seat pad & 1 back pad	44484	45365	46246	47127	48008	48889	49770	50651	51532	52413	53294	54175	55056	58654

SHIPMENT DETAILS	TECHNICAL SPECIFICATIONS	RESISTANCE TEST
<b>Art. 4552</b> 1 pz = 1  - kg 35/ m³ 0,964 <b>Art. 4563</b> 1 pz = 1  - kg 47/ m³ 0,964	<b>Art.4552</b> COL requirement m² 5.4 H 140 cm. COM Meterage m 2.61 <b>Art.4563</b> COL requirement m² 5.47 H 140 cm. COM Meterage m 2.77	
Classe 11M Omologazione Italia Elmosoft. Remix 3 Kvadrat. Coated fabric Valencia Spradling.		

Frame Base



V44  
matt

Shell



LM00022



# Zinta Waiting Laminate

Design by Lievore Altherr Molina, 2014

Modular seat components with laminate shell. Steel frame and aluminium legs lacquered in anthracite colour. Shell with upholstered seat and backrest in fabric, customer's material, leather or coated fabric pads placed on the seat and backrest. The modules can be combined to create linear or L-shaped arrangements.

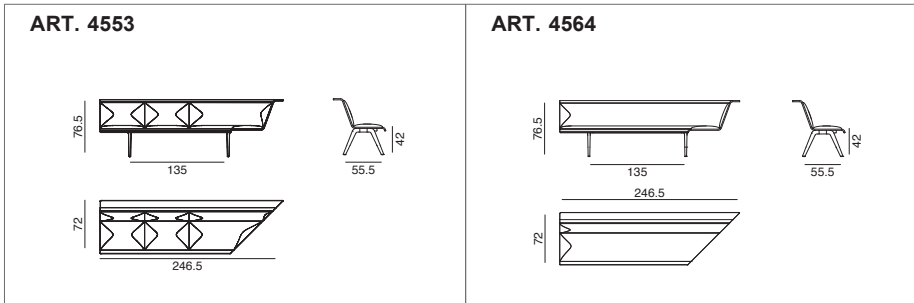

SEK ART. 4553	A	B COM	C COL	D	E	F	G	H	I	J	K	L	M	ES
3 seater, 90° left angular bench - 3 seat pad & 3 back pad	44353	45187	46021	46855	47689	48523	49357	50191	51025	51859	52693	53527	54361	57749
SEK ART. 4564	A	B COM	C COL	D	E	F	G	H	I	J	K	L	M	ES
3 seater, 90° left angular bench - 1 seat pad & 1 back pad	44484	45365	46246	47127	48008	48889	49770	50651	51532	52413	53294	54175	55056	58654

SHIPMENT DETAILS	TECHNICAL SPECIFICATIONS	RESISTANCE TEST
<b>Art. 4553</b> 1 pz = 1  - kg 35/ m² 0,964 <b>Art. 4564</b> 1 pz = 1  - kg 47/ m² 0,964	<b>Art.4553</b> COL requirement m² 5.4 H 140 cm. COM Meterage m 2.61 <b>Art.4564</b> COL requirement m² 5.47 H 140 cm. COM Meterage m 2.77	
Classe 1IM Omologazione Italia Elmosoft. Remix 3 Kvadrat. Coated fabric Valencia Spradling.		

Frame Base



V44  
matt

Shell



LM00022



# Zinta Waiting Laminate

Design by Lievore Altherr Molina, 2014

Modular seat components with laminate shell. Steel frame and aluminium legs lacquered in anthracite colour. Shell with upholstered seat and backrest in fabric, customer's material, leather or coated fabric pads placed on the seat and backrest. The modules can be combined to create linear or L-shaped arrangements.

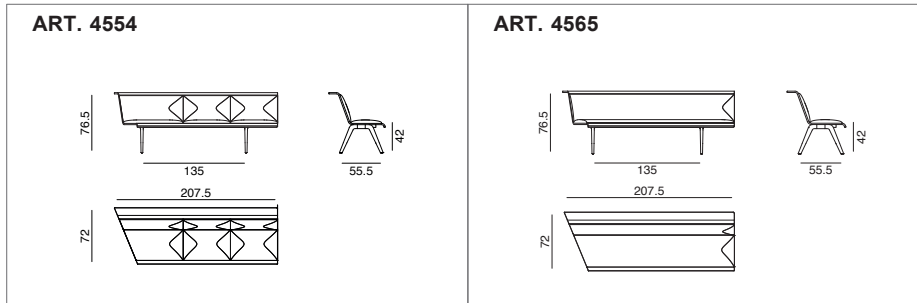

SEK ART. 4554	A	B COM	C COL	D	E	F	G	H	I	J	K	L	M	ES
3 seater, 135° right angular bench - 3 seat pad & 3 back pad	42818	43652	44486	45320	46154	46988	47822	48656	49490	50324	51158	51992	52826	56201
SEK ART. 4565	A	B COM	C COL	D	E	F	G	H	I	J	K	L	M	ES
3 seater, 135° right angular bench - 1 seat pad & 1 back pad	42508	43282	44056	44830	45604	46378	47152	47926	48700	49474	50248	51022	51796	54855

SHIPMENT DETAILS	TECHNICAL SPECIFICATIONS	RESISTANCE TEST
<b>Art. 4554</b> 1 pz = 1  - kg 35/ m² 0,964 <b>Art. 4565</b> 1 pz = 1  - kg 47/ m² 0,964	<b>Art.4554</b> COL requirement m² 5.4 H 140 cm. COM Meterage m 2.61 <b>Art.4565</b> COL requirement m² 5.29 H 140 cm. COM Meterage m 2.43	
Classe 11M Omologazione Italia Elmosoft. Remix 3 Kvadrat. Coated fabric Valencia Spradling.		

Frame Base



Shell



# Zinta Waiting Laminate

Design by Lievore Altherr Molina, 2014

Modular seat components with laminate shell. Steel frame and aluminium legs lacquered in anthracite colour. Shell with upholstered seat and backrest in fabric, customer's material, leather or coated fabric pads placed on the seat and backrest. The modules can be combined to create linear or L-shaped arrangements.

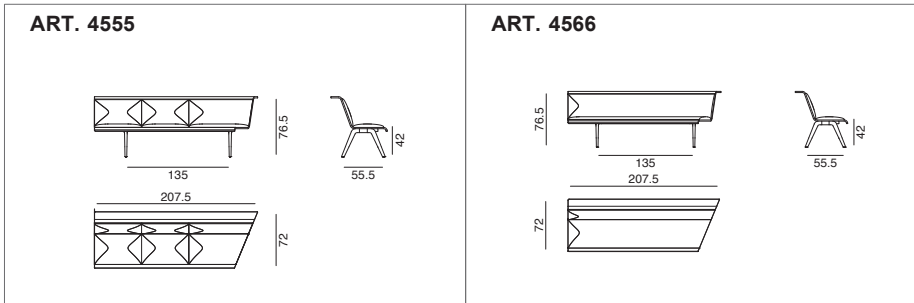

SEK ART. 4555	A	B COM	C COL	D	E	F	G	H	I	J	K	L	M	ES
3 seater, 135° left angular bench - 3 seat pad & 3 back pad	42818	43652	44486	45320	46154	46988	47822	48656	49490	50324	51158	51992	52826	56201
SEK ART. 4566	A	B COM	C COL	D	E	F	G	H	I	J	K	L	M	ES
3 seater, 135° left angular bench - 1 seat pad & 1 back pad	42508	43282	44056	44830	45604	46378	47152	47926	48700	49474	50248	51022	51796	54855

SHIPMENT DETAILS	TECHNICAL SPECIFICATIONS	RESISTANCE TEST
<b>Art. 4555</b> 1 pz = 1  - kg 35/ m² 0,964 <b>Art. 4566</b> 1 pz = 1  - kg 56/ m² 0,964	<b>Art.4555</b> COL requirement m² 5.4 H 140 cm. COM Meterage m 2.61 <b>Art.4566</b> COL requirement m² 5.29 H 140 cm. COM Meterage m 2.43	
Classe 1IM Omologazione Italia Elmosoft. Remix 3 Kvadrat. Coated fabric Valencia Spradling.		

Frame Base



Shell



# Accessories

Design by Lievore Altherr Molina, 2014



<b>SEK ART. 4570</b>	V44	
Link kit for modules Waiting	774	

SHIPMENT DETAILS	TECHNICAL SPECIFICATIONS	RESISTANCE TEST
<b>FIRE RETARDANT TEST</b>		



# Zinta Eating Wood

Design by Lievore Altherr Molina, 2014

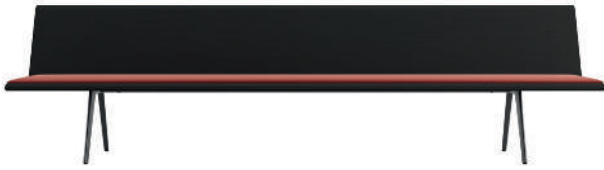

Modular seat components with oak veneered plywood frame, available in several colors. Steel frame and aluminum legs lacquered in anthracite color. The shell can be fitted without pads or with upholstered seat in fabric, customer's material, leather or coated fabric pads placed on the seat and backrest. The modules can be combined to create linear or L-shaped arrangements.

Accessories:  
Link Kit Art. 4624

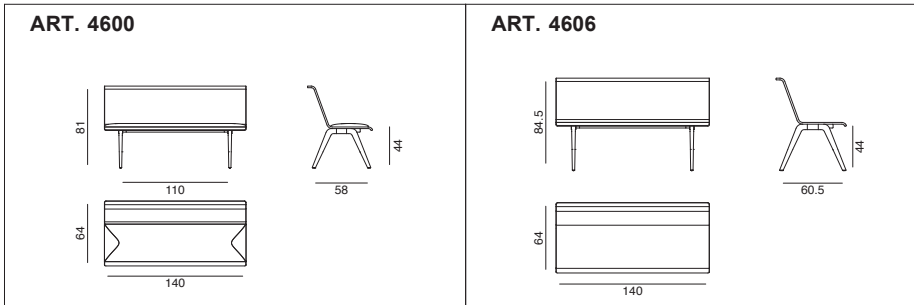

<b>SEK ART. 4600</b>	A	B COM	C COL	D	E	F	G	H	I	J	K	L	M	ES
Bench L 1400 - seat pad	29934	30493	31052	31611	32170	32729	33288	33847	34406	34965	35524	36083	36642	38972
<b>SEK ART. 4606</b>	WOOD													
Bench L 1400	27053													
Wall fixing bracket - replacing the legs	+	929	<b>Art. 4600</b>											
Wall fixing bracket - replacing the legs	+	929	<b>Art. 4606</b>											

SHIPMENT DETAILS	TECHNICAL SPECIFICATIONS	RESISTANCE TEST
<b>Art. 4600</b> 1 pz = 1  - kg 34/ m² 0,574 <b>Art. 4606</b> 1 pz = 1  - kg 29/ m² 0,574	<b>Art.4600</b> COL requirement m² 1.8 H 140 cm. COM Meterage m 1.75	<ul style="list-style-type: none"> <li>• EN 1728:2012 - EN 16139:2013 6.15</li> <li>• EN 1728:2012 - EN 16139:2013 6.17</li> <li>• EN 1728:2012 - EN 16139:2013 6.24</li> <li>• EN 1728:2012 - EN 16139:2013 6.4</li> </ul> <ul style="list-style-type: none"> <li>• EN 1728:2012 - EN 16139:2013 6.16</li> <li>• EN 1728:2012 - EN 16139:2013 6.18</li> <li>• EN 1728:2012 - EN 16139:2013 6.25</li> <li>• EN 1728:2012 - EN 16139:2013 6.5</li> </ul>
<b>FIRE RETARDANT TEST</b> Classe 1IM Omologazione Italia Elmosoft. Remix 3 Kvadrat. Coated fabric Valencia Spradling.		

Frame Base



V44  
matt

Shell



L0006



L0022



L0023





# Zinta Eating Wood

Design by Lievore Altherr Molina, 2014

Modular seat components with oak veneered plywood frame, available in several colors. Steel frame and aluminum legs lacquered in anthracite color. The shell can be fitted without pads or with upholstered seat in fabric, customer's material, leather or coated fabric pads placed on the seat and backrest. The modules can be combined to create linear or L-shaped arrangements.

Accessories:  
Link Kit Art. 4624

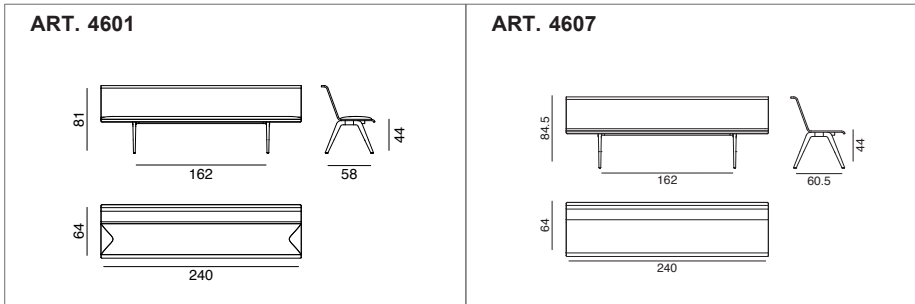

SEK ART. 4601	A	B COM	C COL	D	E	F	G	H	I	J	K	L	M	ES
Bench L 2400 - seat pad	41508	42401	43294	44187	45080	45973	46866	47759	48652	49545	50438	51331	52224	55927
<b>SEK ART. 4607</b>	<b>WOOD</b>													
Bench L 2400	36674													
Wall fixing bracket - replacing the legs	+	929	<b>Art. 4601</b>											
Wall fixing bracket - replacing the legs	+	929	<b>Art. 4607</b>											

SHIPMENT DETAILS	TECHNICAL SPECIFICATIONS	RESISTANCE TEST
<b>Art. 4601</b> 1 pz = 1  - kg 50/ m² 0,925 <b>Art. 4607</b> 1 pz = 1  - kg 42/ m² 0,925	<b>Art.4601</b> COL requirement m² 3.24 H 140 cm. COM Meterage m 2.85	<ul style="list-style-type: none"> <li>• EN 1728:2012 - EN 16139:2013 6.15</li> <li>• EN 1728:2012 - EN 16139:2013 6.4</li> <li>• EN 1728:2012 - EN 16139:2013 6.16</li> <li>• EN 1728:2012 - EN 16139:2013 6.5</li> </ul>
Classe 11M Omologazione Italia Elmosoft. Remix 3 Kvadrat. Coated fabric Valencia Spradling.		

Frame Base



V44  
matt

Shell



L0006



L0022



L0023



# Zinta Eating Wood

Design by Lievore Altherr Molina, 2014

Modular seat components with oak veneered plywood frame, available in several colors. Steel frame and aluminum legs lacquered in anthracite color. The shell can be fitted without pads or with upholstered seat in fabric, customer's material, leather or coated fabric pads placed on the seat and backrest. The modules can be combined to create linear or L-shaped arrangements.

Accessories:  
Link Kit Art. 4624

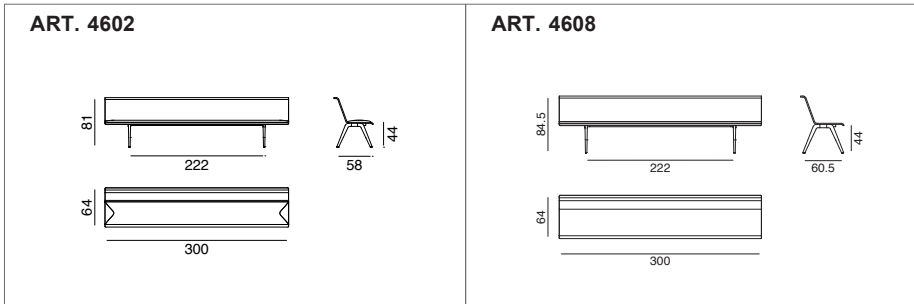

SEK ART. 4602	A	B COM	C COL	D	E	F	G	H	I	J	K	L	M	ES
Bench L 3000 - seat pad	48462	49557	50652	51747	52842	53937	55032	56127	57222	58317	59412	60507	61602	66239
<b>SEK ART. 4608</b>	<b>WOOD</b>													
Bench L 3000	45865													
Wall fixing bracket - replacing the legs	+	929	<b>Art. 4602</b>											
Wall fixing bracket - replacing the legs	+	929	<b>Art. 4608</b>											

SHIPMENT DETAILS	TECHNICAL SPECIFICATIONS	RESISTANCE TEST
<b>Art. 4602</b> 1 pz = 1  - kg 62/ m³ 1,136 <b>Art. 4608</b> 1 pz = 1  - kg 52/ m³ 1,136	<b>Art. 4602</b> COL requirement m² 3.96 H 140 cm. COM Meterage m 3.51	<ul style="list-style-type: none"> <li>• EN 1728:2012 - EN 16139:2013 6.15</li> <li>• EN 1728:2012 - EN 16139:2013 6.17</li> <li>• EN 1728:2012 - EN 16139:2013 6.24</li> <li>• EN 1728:2012 - EN 16139:2013 6.4</li> </ul> <ul style="list-style-type: none"> <li>• EN 1728:2012 - EN 16139:2013 6.16</li> <li>• EN 1728:2012 - EN 16139:2013 6.18</li> <li>• EN 1728:2012 - EN 16139:2013 6.25</li> <li>• EN 1728:2012 - EN 16139:2013 6.5</li> </ul>
Classe 1IM Omologazione Italia Elmosoft. Remix 3 Kvadrat. Coated fabric Valencia Spradling.		

Frame Base



V44  
matt

Shell



L0006



L0022



L0023



# Zinta Eating Wood

Design by Lievore Altherr Molina, 2014

Modular seat components with oak veneered plywood frame, available in several colors. Steel frame and aluminum legs lacquered in anthracite color. The shell can be fitted without pads or with upholstered seat in fabric, customer's material, leather or coated fabric pads placed on the seat and backrest. The modules can be combined to create linear or L-shaped arrangements.

Accessories:  
Link Kit Art. 4624

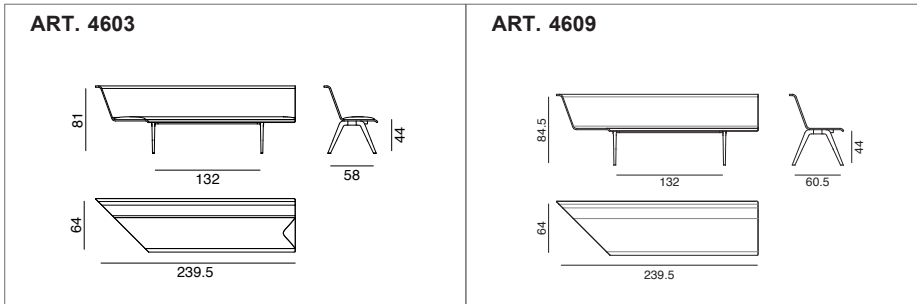

SEK ART. 4603	A	B COM	C COL	D	E	F	G	H	I	J	K	L	M	ES
3 seater, 90° right angular bench - seat pad - L 2400	42591	43413	44235	45057	45879	46701	47523	48345	49167	49989	50811	51633	52455	55737
<b>SEK ART. 4609</b>	<b>WOOD</b>													
3 seater, 90° right angular bench L 2400	36292													

SHIPMENT DETAILS	TECHNICAL SPECIFICATIONS	RESISTANCE TEST
<b>Art. 4603</b> 1 pz = 1  - kg 48/ m² 0,923 <b>Art. 4609</b> 1 pz = 1  - kg 42/ m² 0,923	<b>Art.4603</b> COL requirement m² 2.82 H 140 cm. COM Meterage m 2.6	
Classe 11M Omologazione Italia Elmosoft. Remix 3 Kvadrat. Coated fabric Valencia Spradling.		

Frame Base



V44  
matt

Shell



L0006



L0022



L0023



# Zinta Eating Wood

Design by Lievore Altherr Molina, 2014

Modular seat components with oak veneered plywood frame, available in several colors. Steel frame and aluminum legs lacquered in anthracite color. The shell can be fitted without pads or with upholstered seat in fabric, customer's material, leather or coated fabric pads placed on the seat and backrest. The modules can be combined to create linear or L-shaped arrangements.

Accessories:  
Link Kit Art. 4624

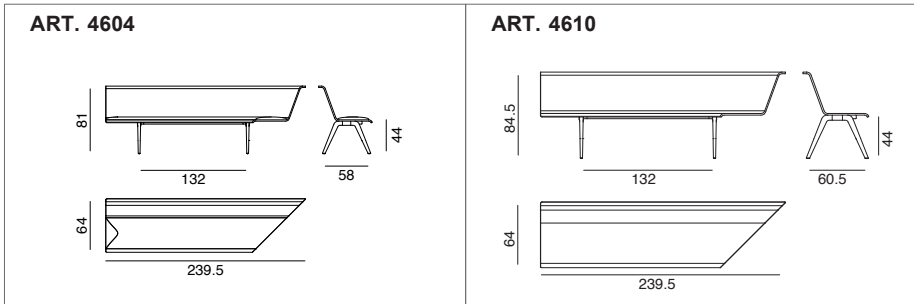

SEK ART. 4604	A	B COM	C COL	D	E	F	G	H	I	J	K	L	M	ES
3 seater, 90° left angular bench - seat pad- L 2400	42591	43413	44235	45057	45879	46701	47523	48345	49167	49989	50811	51633	52455	55737
<b>SEK ART. 4610</b>	WOOD													
3 seater, 90° left angular bench L 2400	36292													

SHIPMENT DETAILS	TECHNICAL SPECIFICATIONS	RESISTANCE TEST
<b>Art. 4604</b> 1 pz = 1  - kg 48/ m² 0,923 <b>Art. 4610</b> 1 pz = 1  - kg 42/ m² 0,923	<b>Art.4604</b> COL requirement m² 2.82 H 140 cm. COM Meterage m 2.6	
Classe 1IM Omologazione Italia Elmosoft. Remix 3 Kvadrat. Coated fabric Valencia Spradling.		

Frame Base



V44  
matt

Shell



L0006



L0022



L0023



# Zinta Eating Laminate

Design by Lievore Altherr Molina, 2014

Modular seat components with laminate shell. Steel frame and aluminum legs lacquered in anthracite colour. The shell can be fitted without pads or with upholstered seat in fabric, customer's material, leather or coated fabric pads placed on the seat and backrest. The modules can be combined to create linear or L-shaped arrangements.

Accessories:  
Link Kit Art. 4624

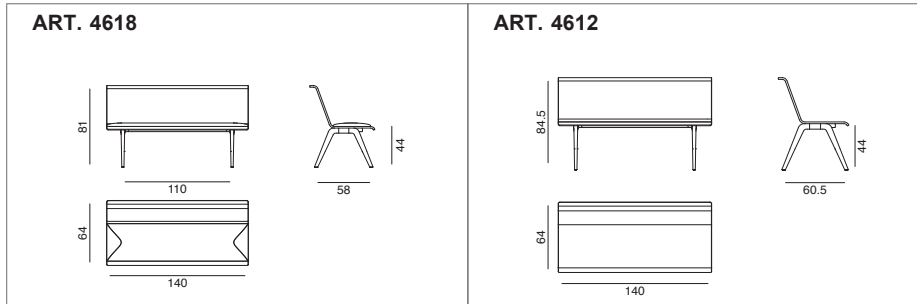

<b>SEK ART. 4612</b>	<b>LM</b>													
Bench L 1400	21468													
<b>SEK ART. 4618</b>	<b>A</b>	<b>B COM</b>	<b>C COL</b>	<b>D</b>	<b>E</b>	<b>F</b>	<b>G</b>	<b>H</b>	<b>I</b>	<b>J</b>	<b>K</b>	<b>L</b>	<b>M</b>	<b>ES</b>
Bench L 1400 - seat pad	25660	26219	26778	27337	27896	28455	29014	29573	30132	30691	31250	31809	32368	34673
Wall fixing bracket - replacing the legs	+ 929	<b>Art. 4612</b>												
Wall fixing bracket - replacing the legs	+ 929	<b>Art. 4618</b>												

SHIPMENT DETAILS	TECHNICAL SPECIFICATIONS	RESISTANCE TEST
<b>Art. 4612</b> 1 pz = 1  - kg 29/ m² 0,574 <b>Art. 4618</b> 1 pz = 1  - kg 34/ m² 0,574	<b>Art.4618</b> COL requirement m² 1.8 H 140 cm. COM Meterage m 1.75	<ul style="list-style-type: none"> <li>• EN 1728:2012 - EN 16139:2013 6.15</li> <li>• EN 1728:2012 - EN 16139:2013 6.17</li> <li>• EN 1728:2012 - EN 16139:2013 6.24</li> <li>• EN 1728:2012 - EN 16139:2013 6.4</li> </ul> <ul style="list-style-type: none"> <li>• EN 1728:2012 - EN 16139:2013 6.16</li> <li>• EN 1728:2012 - EN 16139:2013 6.18</li> <li>• EN 1728:2012 - EN 16139:2013 6.25</li> <li>• EN 1728:2012 - EN 16139:2013 6.5</li> </ul>
Classe 11M Omologazione Italia Elmosoft. Remix 3 Kvadrat. Coated fabric Valencia Spradling.		

Frame Base



Shell



# Zinta Eating Laminate

Design by Lievore Altherr Molina, 2014

Modular seat components with laminate shell. Steel frame and aluminum legs lacquered in anthracite colour. The shell can be used as is, or with upholstered seat pads in fabric, customer's material, leather or coated fabric pads placed on the seat and backrest. The modules can be combined to create linear or L-shaped arrangements.

Accessories:

Link Kit Art. 4624

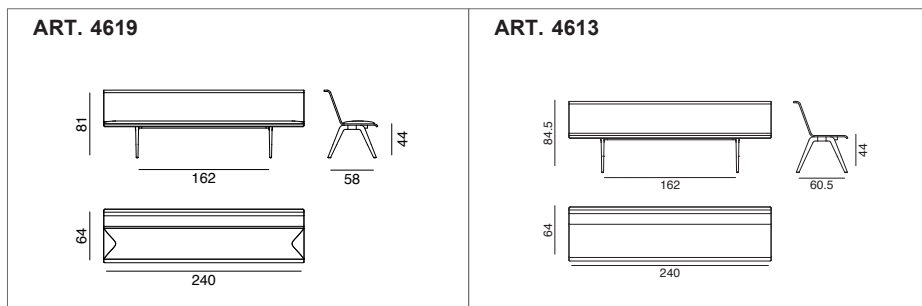

<b>SEK ART. 4613</b>	<b>LM</b>													
Bench L 2400	29363													
<b>SEK ART. 4619</b>	<b>A</b>	<b>B COM</b>	<b>C COL</b>	<b>D</b>	<b>E</b>	<b>F</b>	<b>G</b>	<b>H</b>	<b>I</b>	<b>J</b>	<b>K</b>	<b>L</b>	<b>M</b>	<b>ES</b>
Bench L 2400 - seat pad	35519	36412	37305	38198	39091	39984	40877	41770	42663	43556	44449	45342	46235	49938
Wall fixing bracket - replacing the legs	+ 929	<b>Art. 4613</b>												
Wall fixing bracket - replacing the legs	+ 929	<b>Art. 4619</b>												

SHIPMENT DETAILS	TECHNICAL SPECIFICATIONS	RESISTANCE TEST
<b>Art. 4613</b> 1 pz = 1  - kg 42/ m² 0,925 <b>Art. 4619</b> 1 pz = 1  - kg 50/ m² 0,925	<b>Art.4619</b> COL requirement m² 3.24 H 140 cm. COM Meterage m 2.85	<ul style="list-style-type: none"> <li>• EN 1728:2012 - EN 16139:2013 6.15</li> <li>• EN 1728:2012 - EN 16139:2013 6.18</li> <li>• EN 1728:2012 - EN 16139:2013 6.25</li> <li>• EN 1728:2012 - EN 16139:2013 6.5</li> </ul> <ul style="list-style-type: none"> <li>• EN 1728:2012 - EN 16139:2013 6.16</li> <li>• EN 1728:2012 - EN 16139:2013 6.24</li> <li>• EN 1728:2012 - EN 16139:2013 6.4</li> </ul>
Classe 1IM Omologazione Italia Elmosoft. Remix 3 Kvadrat. Coated fabric Valencia Spradling.		

Frame Base



V44  
matt

Shell



LM00022



# Zinta Eating Laminate

Design by Lievore Altherr Molina, 2014

Modular seat components with laminate shell. Steel frame and aluminum legs lacquered in anthracite colour. The shell can be used as is, or with upholstered seat pads in fabric, customer's material, leather or coated fabric pads placed on the seat and backrest. The modules can be combined to create linear or L-shaped arrangements.

Accessories:  
Link Kit Art. 4624

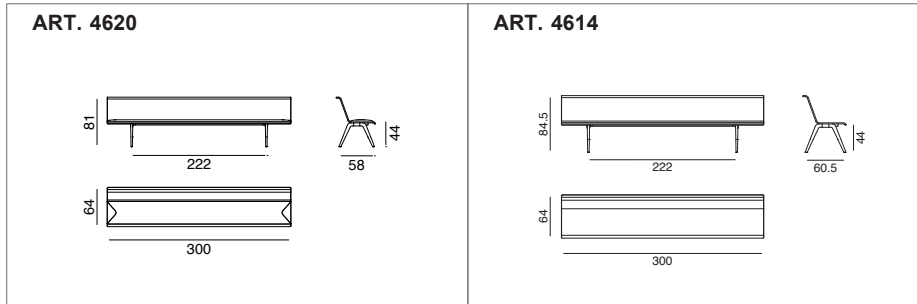

<b>SEK ART. 4614</b>	<b>LM</b>													
Bench L 3000	36674													
<b>SEK ART. 4620</b>	<b>A</b>	<b>B COM</b>	<b>C COL</b>	<b>D</b>	<b>E</b>	<b>F</b>	<b>G</b>	<b>H</b>	<b>I</b>	<b>J</b>	<b>K</b>	<b>L</b>	<b>M</b>	<b>ES</b>
Bench L 3000 - seat pad	39662	40757	41852	42947	44042	45137	46232	47327	48422	49517	50612	51707	52802	57440
Wall fixing bracket - replacing the legs	+ 929	<b>Art. 4614</b>												
Wall fixing bracket - replacing the legs	+ 929	<b>Art. 4620</b>												

SHIPMENT DETAILS	TECHNICAL SPECIFICATIONS	RESISTANCE TEST
<b>Art. 4614</b> 1 pz = 1  - kg 52/ m² 1,136 <b>Art. 4620</b> 1 pz = 1  - kg 62/ m² 1,136	<b>Art.4620</b> COL requirement m² 3.96 H 140 cm. COM Meterage m 3.51	<ul style="list-style-type: none"> <li>• EN 1728:2012 - EN 16139:2013 6.15</li> <li>• EN 1728:2012 - EN 16139:2013 6.17</li> <li>• EN 1728:2012 - EN 16139:2013 6.24</li> <li>• EN 1728:2012 - EN 16139:2013 6.4</li> </ul> <ul style="list-style-type: none"> <li>• EN 1728:2012 - EN 16139:2013 6.16</li> <li>• EN 1728:2012 - EN 16139:2013 6.18</li> <li>• EN 1728:2012 - EN 16139:2013 6.25</li> <li>• EN 1728:2012 - EN 16139:2013 6.5</li> </ul>

Classe 11M Omologazione Italia Elmosoft. Remix 3 Kvadrat. Coated fabric Valencia Spradling.

Frame Base



Shell



# Zinta Eating Laminate

Design by Lievore Altherr Molina, 2014

Modular seat components with laminate shell. Steel frame and aluminum legs lacquered in anthracite colour. The shell can be used as is, or with upholstered seat pads in fabric, customer's material, leather or coated fabric pads placed on the seat and backrest. The modules can be combined to create linear or L-shaped arrangements.

Accessories:

Link Kit Art. 4624

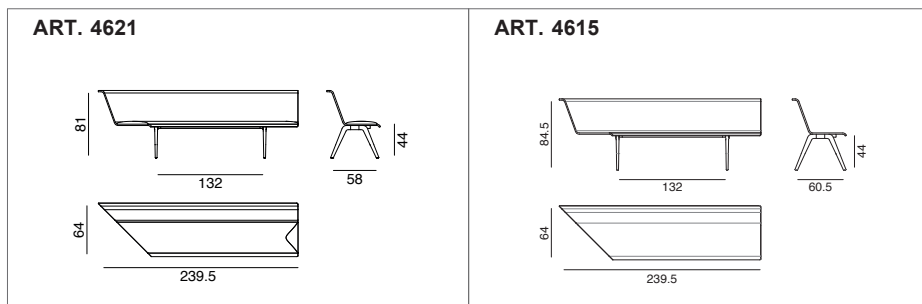

SEK ART. 4615	LM													
3 seater, 90° right angular bench L 2400	30339													
SEK ART. 4621	A	B COM	C COL	D	E	F	G	H	I	J	K	L	M	ES
3 seater, 90° right angular bench - seat pad - L 2400	36638	37460	38282	39104	39926	40748	41570	42392	43214	44036	44858	45680	46502	49772

SHIPMENT DETAILS	TECHNICAL SPECIFICATIONS	RESISTANCE TEST
<b>Art. 4615</b> 1 pz = 1  - kg 42/ m² 0,923 <b>Art. 4621</b> 1 pz = 1  - kg 48/ m² 0,923	<b>Art. 4621</b> COL requirement m² 2.82 H 140 cm. COM Meterage m 2.6	
Classe 1IM Omologazione Italia Elmosoft. Remix 3 Kvadrat. Coated fabric Valencia Spradling.		

Frame Base



V44  
matt

Shell



LM00022





# Zinta Eating Laminate

Design by Lievore Altherr Molina, 2014

Modular seat components with laminate shell. Steel frame and aluminum legs lacquered in anthracite colour. The shell can be used as is, or with upholstered seat pads in fabric, customer's material, leather or coated fabric pads placed on the seat and backrest. The modules can be combined to create linear or L-shaped arrangements.

Accessories:  
Link Kit Art. 4624

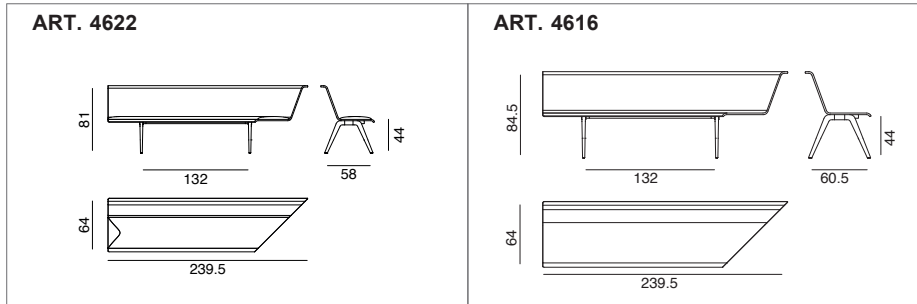

<b>SEK ART. 4616</b>	<b>LM</b>													
3 seater, 90° left angular bench L 2400	30339													
<b>SEK ART. 4622</b>	<b>A</b>	<b>B COM</b>	<b>C COL</b>	<b>D</b>	<b>E</b>	<b>F</b>	<b>G</b>	<b>H</b>	<b>I</b>	<b>J</b>	<b>K</b>	<b>L</b>	<b>M</b>	<b>ES</b>
3 seater, 90° left angular bench - seat pad- L 2400	36638	37460	38282	39104	39926	40748	41570	42392	43214	44036	44858	45680	46502	49772

SHIPMENT DETAILS	TECHNICAL SPECIFICATIONS	RESISTANCE TEST
<b>Art. 4616</b> 1 pz = 1  - kg 42/ m² 0,923 <b>Art. 4622</b> 1 pz = 1  - kg 48/ m² 0,923	<b>Art. 4622</b> COL requirement m² 2.82 H 140 cm. COM Meterage m 2.6	
Classe 11M Omologazione Italia Elmosoft. Remix 3 Kvadrat. Coated fabric Valencia Spradling.		

Frame Base



Shell



# Accessories

Design by Lievore Altherr Molina, 2014



<b>SEK ART. 4624</b>	V44	
Link kit for modules Eating	762	

SHIPMENT DETAILS	TECHNICAL SPECIFICATIONS	RESISTANCE TEST
<b>FIRE RETARDANT TEST</b>		





# TABLES



# CROSS

---

Design by  
Metrica  
2015



# Cross

## Collection overview

### Type



H 74 cm

H 105 cm

H 74 cm — Office

H 105 cm — Office

### Base

	h 74 cm	h 105 cm	h 74 cm	h 105 cm	
	Standard	Standard	Office	Office	
159x59 cm		*			Top thick 32 mm
179x59 cm		*			
200x98 cm	*	*	*	*	
240x98 cm	*	*	*	*	Top thick 35 mm
280x98 cm	*		*		
320x120 cm	*		*		Top thick 37 mm
360x120 cm	*		*		
390x135 cm	*		*		

### Options and accessories



— Linking leg  
It is possible to create linear layouts.



— Power and data unit



— Electrification of the table leg (h 74 cm)



— Cable passageway

Custom electrification available upon request

### Top finishes

- Fenix®
- Wood

# Cross

Design by Metrica, 2014



Table with rectangular top in Fenix® laminate or oak veneered stained natural or wengé. The legs, matching the top, can be positioned flush with the edge or at a distance of 60 cm from the edge. Height: 74 cm.

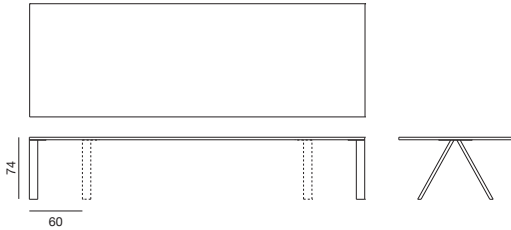

	Top		WOOD	FENIX
<b>SEK ART. 5000</b>	390 x 135 cm	<input type="checkbox"/>	85254	63751
<b>SEK ART. 5002</b>	360 x 120 cm	<input type="checkbox"/>	72037	53832
<b>SEK ART. 5003</b>	320 x 120 cm	<input type="checkbox"/>	69476	48176
<b>SEK ART. 5028</b>	280 x 98 cm	<input type="checkbox"/>	59988	36828

SHIPMENT DETAILS	TECHNICAL SPECIFICATIONS	RESISTANCE TEST
<b>Art. 5000</b> 1 pz = 2  - kg 200/ m³ 1,67 <b>Art. 5002</b> 1 pz = 2  - kg 171/ m³ 1,42 <b>Art. 5003</b> 1 pz = 2  - kg 155/ m³ 1,42 <b>Art. 5028</b> 1 pz = 2  - kg 113/ m³ 1,02		<ul style="list-style-type: none"> <li>• EN 1730:2012 - EN 15372:2016 5.1-5.2</li> <li>• EN 1730:2012 - EN 15372:2016 6.2</li> <li>• EN 1730:2012 - EN 15372:2016 6.3</li> <li>• EN 1730:2012 - EN 15372:2016 6.4.2</li> <li>• EN 1730:2012 - EN 15372:2016 6.6</li> <li>• EN 1730:2012 - EN 15372:2016 6.9</li> <li>• EN 1730:2012 - EN 15372:2016 7.2</li> </ul>
<b>FIRE RETARDANT TEST</b>		

Frame Base

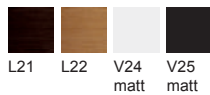

Top

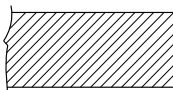
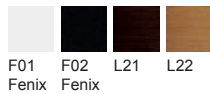

Top shape edge





## Cross

Design by Metrica, 2018

Table with rectangular top in Fenix® laminate or oak veneered stained natural or wengé. The legs, matching the top, can be positioned flush with the edge or at a distance of 45 cm from the edge. Height: 74 cm.

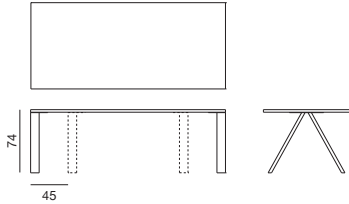

	Top		WOOD	FENIX
<b>SEK ART. 5029</b>	240 x 98 cm <input type="checkbox"/>		57379	32589
<b>SEK ART. 5030</b>	200 x 98 cm <input type="checkbox"/>		44508	24838

SHIPMENT DETAILS	TECHNICAL SPECIFICATIONS	RESISTANCE TEST
<b>Art. 5029</b> 1 pz = 2  - kg 121/ m² 1,02 <b>Art. 5030</b> 1 pz = 2  - kg 103/ m² 0,815		
<b>FIRE RETARDANT TEST</b>		

Frame Base

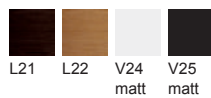

L21 L22 V24 V25  
matt matt

Top

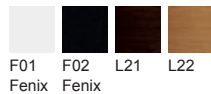

F01 F02 L21 L22  
Fenix Fenix



# Cross

Design by Metrica, 2015

It is possible to create a line made up of several CROSS tables using tops featuring the same depth and thick (see Collection overview) and fitted with the special connection leg (Art. 5014), while a set of legs (Art. 5015) must be positioned at the table ends. For example, for a 6 mt. table you will need 3 200x98 cm tops (Art. 4P00518) + 2 connection legs (Art. 5014) + 1 set of legs (Art. 5015).

ART.		WOOD	FENIX
4P00522	390 x 135 cm.	71228	58369
4P00523	360 x 120 cm.	58011	48450
4P00524	320 x 120 cm	55450	42794
4P00528	240 x 98 cm	43353	27207
4P00530	280 x 98 cm	45962	31446
4P00533	200 x 98 cm	30482	19456



ART.	Frame Base	POWDERCOATED	WOOD
5014	Linking leg	4239	10478
5015	Set of leg	5382	14026

SHIPMENT DETAILS	TECHNICAL SPECIFICATIONS	RESISTANCE TEST
<b>Art. 5014</b> 1 pz = 1  - kg 23/ m³ 0,305		
<b>Art. 5015</b> 1 pz = 1  - kg 32/ m³ 0,246		
<b>FIRE RETARDANT TEST</b>		

Frame Base

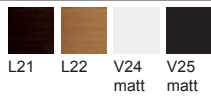

Top

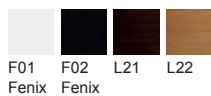

# Cross

Design by Metrica, 2018

Console with Fenix® laminate rectangular top and coated steel legs. The legs are 60 cm wide and are positioned flush with the edge. Height: 105 cm.

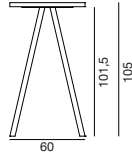
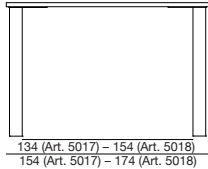
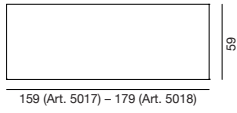

	Top		FENIX
<b>SEK ART. 5017</b>	159 x 59 cm	<input type="checkbox"/>	16360
<b>SEK ART. 5018</b>	179 x 59 cm	<input type="checkbox"/>	17729

SHIPMENT DETAILS	TECHNICAL SPECIFICATIONS	RESISTANCE TEST
<b>Art. 5017</b> 1 pz = 2  - kg 61/ m³ 0,574 <b>Art. 5018</b> 1 pz = 2  - kg 61/ m³ 0,583		
<b>FIRE RETARDANT TEST</b>		

Frame Base



V24  
matt

Top



F01  
Fenix



# Cross

Design by Metrica, 2018

Various linear layouts are possible with more H.105 Cross tables by using same depth and thick tops (see Collection overview) and the special connection leg (Art. 5026), a set of legs (Art. 5023) must be positioned at the table ends. For example, for a 4.8 mt. table you will need 3 159x59 cm (Art. 4P00514) + 2 connection legs (Art. 5026) + 1 set of legs (Art. 5023).

ART.		FENIX
4P00532	179 x 59 cm	10490
4P00535	159 x 59 cm	9121

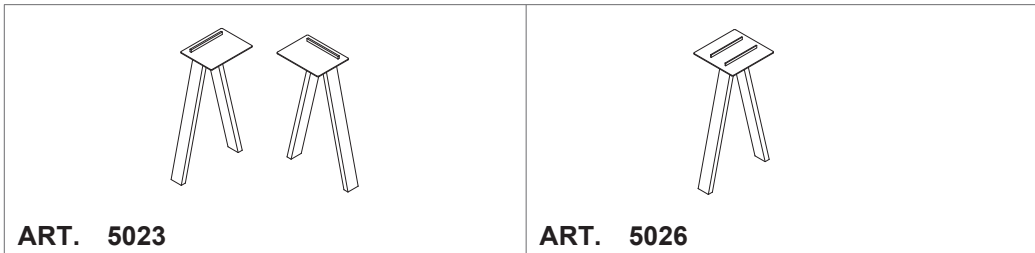

ART.	Frame Base	POWDERCOATED
5023	Set of leg - H 101.5 cm	7239
5026	Linking leg - H 101.5 cm	5192

SHIPMENT DETAILS		TECHNICAL SPECIFICATIONS	RESISTANCE TEST
Art. 5023 1 pz = 1  - kg 37/ m³ 0,502	Art. 5026 1 pz = 1  - kg 23/ m³ 0,502		
<b>FIRE RETARDANT TEST</b>			

Frame Base



V24  
matt

Top



F01  
Fenix



# Cross

Design by Metrica, 2018

Table with Fenix® laminate rectangular top and coated steel legs. The legs are 90 cm wide and can be positioned flush with the edge or at a distance of 45 cm from the edge. Height: 105 cm.

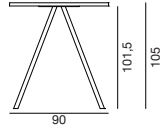
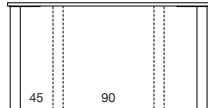
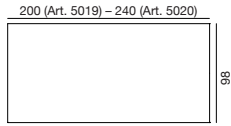

175 (Art. 5019) - 215 (Art. 5020)  
195 (Art. 5019) - 235 (Art. 5020)

	Top		FENIX
<b>SEK ART. 5019</b>	200 x 98 cm	<input type="checkbox"/>	26695
<b>SEK ART. 5020</b>	240 x 98 cm	<input type="checkbox"/>	34446

SHIPMENT DETAILS	TECHNICAL SPECIFICATIONS	RESISTANCE TEST
<b>Art. 5019</b> 1 pz = 2  - kg 119/ m² 1,358 <b>Art. 5020</b> 1 pz = 2  - kg 119/ m² 1,073		
<b>FIRE RETARDANT TEST</b>		

Frame Base



Top

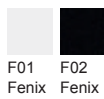

# Cross

Design by Metrica, 2018

Various linear layouts are possible with more H.105 Cross tables by using same depth and thick tops (see Collection overview) and the special connection leg (Art. 5027), a set of legs (Art. 5024) must be positioned at the table ends. For example, for a 6 mt. Table you will need 3 200x98 cm tops (Art. 4P00518) + 2 connection legs (Art. 5027) + 1 set of legs (Art. 5024).

ART.		FENIX
4P00528	240 x 98 cm	27207
4P00533	200 x 98 cm	19456

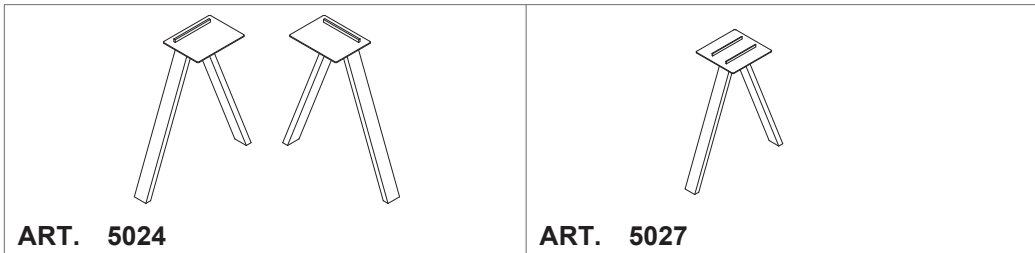

ART.	Frame Base	POWDERCOATED
5024	Set of leg - H 101.5 cm	7239
5027	Linking leg - H 101.5 cm	5192

SHIPMENT DETAILS	TECHNICAL SPECIFICATIONS	RESISTANCE TEST
<b>Art. 5024</b> 1 pz = 1  - kg 38/ m³ 0,502	<b>Art. 5027</b> 1 pz = 1  - kg 23/ m³ 0,502	
<b>FIRE RETARDANT TEST</b>		

Frame Base



Top

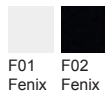



# Cross Office



Design by Metrica, 2015

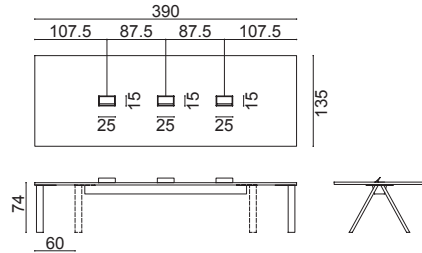

Table with rectangular top with fixed opening, equipped with three power and data units and cable duct (in white or black finish), leg equipped with cables. Table available with top in Fenix® laminate or oak veneered stained natural or wengé. The position of the legs, matching the top, shall be defined upon ordering and it can be flush with the edge or at a distance of 60 cm from the edge. Height: 74 cm.



	Top	WOOD	FENIX
<b>SEK ART. 5034</b>	390 x 135 cm 	118020	95767

SHIPMENT DETAILS	TECHNICAL SPECIFICATIONS	RESISTANCE TEST
<b>Art. 5034</b> 1 pz = 10  - kg 224,3/ m³ 1,81 1 pz = 10  - kg 229/ m³ 1,86 	<b>Art.5034</b> Power and data unit Coni Bachmann: complies with the essential requirements of the following directives and standards: CE marking, DEKRA (UK sockets only). Electric sockets available: P40 (Schuko + IT), G (UK), K (DK), E (FR), J (CH), B (USA). Power and data unit: N°2x (250V) / 10-16A – USB port A 5V, 3.0A, 18W + USB C 5V, 3.0A, 22W. Custom electrification available upon request.	
<b>FIRE RETARDANT TEST</b>		

Frame Base

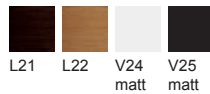

Top

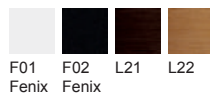

Power and data unit





# Cross Office



Design by Metrica, 2015

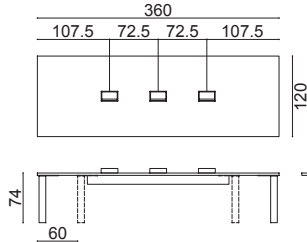

Table with rectangular top with fixed opening, equipped with three power and data units and cable duct (in white or black finish), leg equipped with cables. Table available with top in Fenix® laminate or oak veneered stained natural or wengé. The position of the legs, matching the top, shall be defined upon ordering and it can be flush with the edge or at a distance of 60 cm from the edge. Height: 74 cm.



	Top	WOOD	FENIX
<b>SEK ART. 5035</b>	360 x 120 cm 	105399	86063

SHIPMENT DETAILS	TECHNICAL SPECIFICATIONS	RESISTANCE TEST
<b>Art. 5035</b> 1 pz = 10  - kg 194/ m³ 1,55 1 pz = 10  - kg 198,8/ m³ 1,59 	<b>Art. 5035</b> Power and data unit Coni Bachmann: complies with the essential requirements of the following directives and standards: CE marking, DEKRA (UK sockets only). Electric sockets available: P40 (Schuko + IT), G (UK), K (DK), E (FR), J (CH), B (USA). Power and data unit: N°2x (250V) / 10-16A – USB port A 5V, 3.0A, 18W + USB C 5V, 3.0A, 22W. Custom electrification available upon request.	
<b>FIRE RETARDANT TEST</b>		

Frame Base

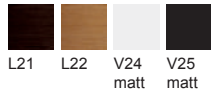

Top

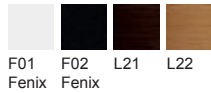

Power and data unit





# Cross Office

Design by Metrica, 2015



Table with rectangular top with fixed opening, equipped with two power and data units and cable duct (in white or black finish), leg equipped with cables. Table available with top in Fenix® laminate or oak veneered stained natural or wengé. The position of the legs, matching the top, shall be defined upon ordering and it can be flush with the edge or at a distance of 60 cm from the edge. Height: 74 cm.

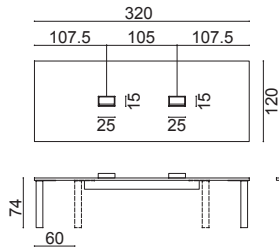

	Top	WOOD	FENIX
<b>SEK ART. 5036</b>	320 x 120 cm <input type="checkbox"/>	94421	71405

SHIPMENT DETAILS	TECHNICAL SPECIFICATIONS	RESISTANCE TEST
<b>Art. 5036</b> 1 pz = 8  - kg 159,2/ m³ 1,56 1 pz = 8  - kg 164/ m³ 1,56 	<b>Art.5036</b> Power and data unit Coni Bachmann: complies with the essential requirements of the following directives and standards: CE marking, DEKRA (UK sockets only). Electric sockets available: P40 (Schuko + IT), G (UK), K (DK), E (FR), J (CH), B (USA). Power and data unit: N°2x (250V) / 10-16A – USB port A 5V, 3.0A, 18W + USB C 5V, 3.0A, 22W. Custom electrification available upon request.	
<b>FIRE RETARDANT TEST</b>		

Frame Base

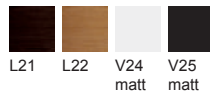

Top

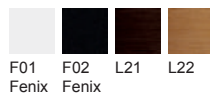

Power and data unit





# Cross Office



Design by Metrica, 2015

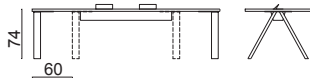
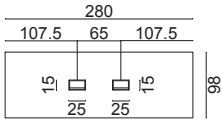

Table with rectangular top with fixed opening, equipped with two power and data units and cable duct (in white or black finish), leg equipped with cables. Table available with top in Fenix® laminate or oak veneered stained natural or wengé. The position of the legs, matching the top, shall be defined upon ordering and it can be flush with the edge or at a distance of 60 cm from the edge. Height: 74 cm.



	Top	WOOD	FENIX
<b>SEK ART. 5039</b>	280 x 98 cm 	85336	64083

SHIPMENT DETAILS	TECHNICAL SPECIFICATIONS	RESISTANCE TEST
<b>Art. 5039</b> 1 pz = 8  - kg 128,8/ m² 1,152 1 pz = 8  - kg 133,6/ m² 1,15	<b>Art. 5039</b> Power and data unit Coni Bachmann: complies with the essential requirements of the following directives and standards: CE marking, DEKRA (UK sockets only). Electric sockets available: P40 (Schuko + IT), G (UK), K (DK), E (FR), J (CH), B (USA). Power and data unit: N°2x (250V) / 10-16A – USB port A 5V, 3.0A, 18W + USB C 5V, 3.0A, 22W. Custom electrification available upon request.	
<b>FIRE RETARDANT TEST</b>		

Frame Base

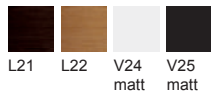

Top

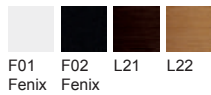

Power and data unit





# Cross Office



Design by Metrica, 2015

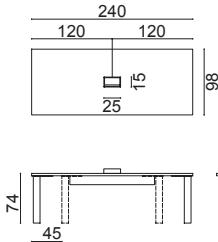

Table with rectangular top with fixed opening, equipped with one power and data unit and cable duct (in white or black finish), leg equipped with cables. Table available with top in Fenix® laminate or oak veneered stained natural or wengé. The position of the legs, matching the top, shall be defined upon ordering and it can be flush with the edge or at a distance of 45 cm from the edge. Height: 74 cm.



	Top	WOOD	FENIX
<b>SEK ART. 5040</b>	240 x 98 cm 	74489	47711

SHIPMENT DETAILS	TECHNICAL SPECIFICATIONS	RESISTANCE TEST
<b>Art. 5040</b> 1 pz = 6  - kg 132,4/ m³ 1,118 1 pz = 6  - kg 135,8/ m³ 1,086	<b>Art.5040</b> Power and data unit Coni Bachmann: complies with the essential requirements of the following directives and standards: CE marking, DEKRA (UK sockets only). Electric sockets available: P40 (Schuko + IT), G (UK), K (DK), E (FR), J (CH), B (USA). Power and data unit: N°2x (250V) / 10-16A – USB port A 5V, 3.0A, 18W + USB C 5V, 3.0A, 22W. Custom electrification available upon request.	
<b>FIRE RETARDANT TEST</b>		

Frame Base

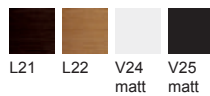

Top

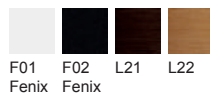

Power and data unit





# Cross Office



Design by Metrica, 2015

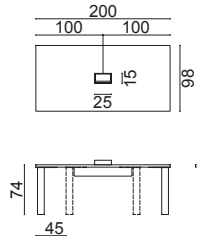

Table with rectangular top with fixed opening, equipped with one power and data unit and cable duct (in white or black finish), leg equipped with cables. Table available with top in Fenix® laminate or oak veneered stained natural or wengé. The position of the legs, matching the top, shall be defined upon ordering and it can be flush with the edge or at a distance of 45 cm from the edge. Height: 74 cm.



	Top	WOOD	FENIX
<b>SEK ART. 5041</b>	200 x 98 cm 	62201	39960

SHIPMENT DETAILS	TECHNICAL SPECIFICATIONS	RESISTANCE TEST
<b>Art. 5041</b> 1 pz = 6  - kg 113,6/ m² 0,893 1 pz = 6  - kg 116,1/ m² 0,861	<b>Art.5041</b> Power and data unit Coni Bachmann: complies with the essential requirements of the following directives and standards: CE marking, DEKRA (UK sockets only). Electric sockets available: P40 (Schuko + IT), G (UK), K (DK), E (FR), J (CH), B (USA). Power and data unit: N°2x (250V) / 10-16A – USB port A 5V, 3.0A, 18W + USB C 5V, 3.0A, 22W. Custom electrification available upon request.	
<b>FIRE RETARDANT TEST</b>		

Frame Base

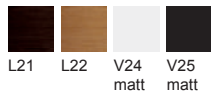

Top

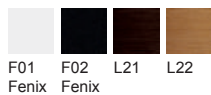

Power and data unit



# Cross Office

Design by Metrica, 2018



Table with rectangular top with fixed opening, equipped with one power and data unit and cable duct (in white or black finish), leg equipped with cables. Table with Fenix® laminate rectangular top and coated steel legs. The position of the 90 cm wide legs shall be defined upon ordering and it can be flush with the edge or at a distance of 45 cm from the edge. Height: 105 cm.

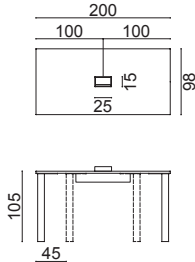

	Top	FENIX
<b>SEK ART. 5037</b>	200 x 98 cm <input type="checkbox"/>	41841

SHIPMENT DETAILS	TECHNICAL SPECIFICATIONS	RESISTANCE TEST
<b>Art. 5037</b> 1 pz = 6  - kg 115,1/ m³ 1,157 1 pz = 6  - kg 120,9/ m³ 1,221	<b>Art.5037</b> Power and data unit Coni Bachmann: complies with the essential requirements of the following directives and standards: CE marking, DEKRA (UK sockets only). Electric sockets available: P40 (Schuko + IT), G (UK), K (DK), E (FR), J (CH), B (USA). Power and data unit: N°2x (250V) / 10-16A – USB port A 5V, 3.0A, 18W + USB C 5V, 3.0A, 22W. Custom electrification available upon request.	
<b>FIRE RETARDANT TEST</b>		

Frame Base



Top

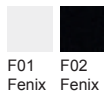

Power and data unit



# Cross Office

Design by Metrica, 2018



Table with rectangular top with fixed opening, equipped with one power and data unit and cable duct (in white or black finish), leg equipped with cables. Table with Fenix® laminate rectangular top and coated steel legs. The position of the 90 cm wide legs shall be defined upon ordering and it can be flush with the edge or at a distance of 45 cm from the edge. Height: 105 cm.

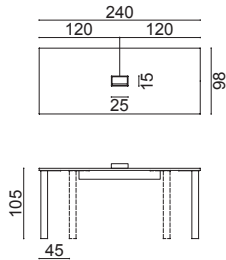

	Top	FENIX
<b>SEK ART. 5038</b>	240 x 98 cm <input type="checkbox"/>	49592

SHIPMENT DETAILS	TECHNICAL SPECIFICATIONS	RESISTANCE TEST
<b>Art. 5038</b> 1 pz = 6  - kg 131,7/ m² 1,403 1 pz = 6  - kg 137,7/ m² 1,468	<b>Art. 5038</b> Power and data unit Coni Bachmann: complies with the essential requirements of the following directives and standards: CE marking, DEKRA (UK sockets only). Electric sockets available: P40 (Schuko + IT), G (UK), K (DK), E (FR), J (CH), B (USA). Power and data unit: N°2x (250V) / 10-16A – USB port A 5V, 3.0A, 18W + USB C 5V, 3.0A, 22W. Custom electrification available upon request.	
<b>FIRE RETARDANT TEST</b>		

Frame Base



Top

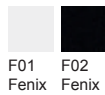

Power and data unit





# DIZZIE

Design by  
Lievore Altherr Molina  
2004





# Dizzie

## Collection overview

### Oval base



H 35 cm

H 43 cm

H 50 cm

H 74 cm

H 105 cm

#### Base

		h 35 cm	h 43 cm	h 50 cm	h 74 cm	h 105 cm
<b>Round top</b>	Ø 80 cm				*	*
<b>Oval top</b>	51x47cm		*	*		
	90x108cm	*			*	
	100x135cm	*			*	
	100x160cm				*	
	100x182cm				*	
<b>Square top</b>	80x80cm				*	

Actual top/finish dimensions are available in the price list.

# Dizzie

## Round base



H 35 cm



H 74 cm



H 105 cm

## Square base



H 74 cm

		Base		
		h 35 cm	h 74 cm	h 105 cm
Round top	Ø 80 cm	*	*	*
	Ø 90 cm	*	*	
	Ø 100 cm		*	
	Ø 120 cm		*	
	Ø 134 cm		*	
	Ø 160 cm		*	
Square top	80x80cm		*	*

		Base
		h 74 cm
Square top		80x80cm

Actual top/finish dimensions are available in the price list.

## Top finishes

- MDF
- Fenix®
- Marble



# Dizzie



Design by Lievore Altherr Molina, 2004

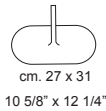
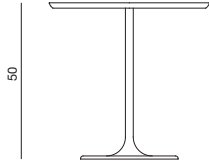

Art. 0681: low table with steel oval base powder-coated white, moka, red, ivory or black, with oval top in white laminate (Thick 1,7 cm). Art. 0680: low table with anthracite powder-coated steel oval base and brushed oak veneered MDF oval top available in natural or black finishes (Thick 1,7 cm). Height: 50 cm.



	Top	V44	
<b>SEK ART. 0680</b>	MDF MD cm 51x47		5775
	Top	Other available colours	White
<b>SEK ART. 0681</b>	MDF MD cm 51x47		4846 4488

SHIPMENT DETAILS	TECHNICAL SPECIFICATIONS	RESISTANCE TEST
<b>Art. 0680</b> 1 pz = 1  - kg 10,5/ m³ 0,099 <b>Art. 0681</b> 1 pz = 1  - kg 10,5/ m³ 0,099		<ul style="list-style-type: none"> <li>• EN 1730:2012 - EN 15372:2016 6.2</li> <li>• EN 1730:2012 - EN 15372:2016 6.4.2</li> <li>• EN 1730:2012 - EN 15372:2016 6.3</li> <li>• EN 1730:2012 - EN 15372:2016 6.5</li> </ul>
<b>FIRE RETARDANT TEST</b>		

Frame Base  
**ART. 0680**



Top  
**ART. 0680**

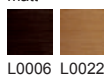

Frame Base  
**ART. 0681**



Top  
**ART. 0681**

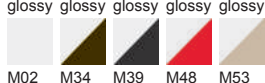

# Dizzie

Design by Lievore Altherr Molina, 2019

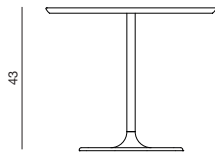

Art. 0900: Side table with oval anthracite powder-coated steel base and brushed oak veneered MDF oval top available in natural or black finishes (thickness: 1.7cm). Art. 0901: Side table with oval white powder-coated steel base and oval top in embossed white painted MDF (thickness: 1.7 cm). Height: 43 cm.

	Top	V44	
<b>SEK ART. 0900</b>	MDF MD cm 51x47	5775	
	Top	V12	
<b>SEK ART. 0901</b>	MDF MD cm 51x47	4488	

SHIPMENT DETAILS	TECHNICAL SPECIFICATIONS	RESISTANCE TEST
<b>Art. 0900</b> 1 pz = 1  - kg 10,46/ m³ 0,107 <b>Art. 0901</b> 1 pz = 1  - kg 10,46/ m³ 0,107		
<b>FIRE RETARDANT TEST</b>		

Frame Base  
**ART. 0900**



V44  
matt

Top  
**ART. 0900**



L0006 L0022

Frame Base  
**ART. 0901**



V12  
glossy

Top  
**ART. 0901**



M02

# Dizzie

Design by Lievore Altherr Molina, 2018

Side table with white or anthracite coated steel oval base and white polished Italian marble oval top (2 cm thick). Height: 50 cm.

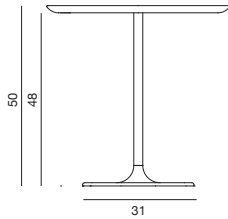

	Top	
<b>SEK ART. 0743</b>	B01 51 x 47 cm	10942

SHIPMENT DETAILS	TECHNICAL SPECIFICATIONS	RESISTANCE TEST
<b>Art. 0743</b> 1 pz = 2  - kg 17,67/ m³ 0,132		
<b>FIRE RETARDANT TEST</b>		

Frame Base



V12 V44  
glossy matt

Top



B01



# Dizzie

Design by Lievore Altherr Molina, 2018

Side table with white or anthracite coated steel oval base and white polished Italian marble oval top (2 cm thick). Height: 43 cm.

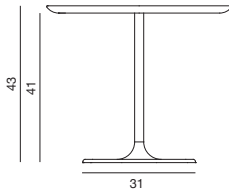

	Top	
<b>SEK ART. 0742</b>	B01 51 x 47 cm	10727

SHIPMENT DETAILS	TECHNICAL SPECIFICATIONS	RESISTANCE TEST
<b>Art. 0742</b> 1 pz = 2  - kg 17,63/ m² 0,132		
<b>FIRE RETARDANT TEST</b>		

Frame Base



V12 V44  
glossy matt

Top



B01



# Dizzie

Design by Lievore Altherr Molina, 2024

Table with round base in white glossy or black matt powder coated steel, round top in white embossed MDF (Thick 2,5 cm) or laminate Fenix ® (Thick 2,6 cm). Height 35 cm.

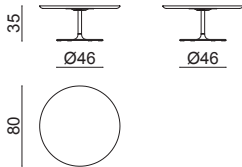

	Top	
<b>SEK ART. 0905</b>	STRUCTURE ONLY	6966
<b>SEK ART. 0906</b>	MDF MD Ø cm 80	10241
<b>SEK ART. 0907</b>	Fenix ® Ø cm 79	11859

SHIPMENT DETAILS	TECHNICAL SPECIFICATIONS	RESISTANCE TEST
<b>Art. 0905</b> 1 pz = 1  - kg 20,6/ m³ 0,135 <b>Art. 0906</b> 1 pz = 2  - kg 31,1/ m³ 0,177 <b>Art. 0907</b> 1 pz = 2  - kg 31,1/ m³ 0,177		
<b>FIRE RETARDANT TEST</b>		

Frame Base



V12 V39  
glossy matt

Top

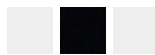

F01 F02 M02  
Fenix Fenix



# Dizzie

Design by Lievore Altherr Molina, 2018

Table with white coated steel round base. White polished Italian marble round top (2 cm thick). Height: 35 cm.

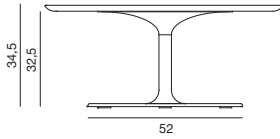

	Top	
<b>SEK ART. 0749</b>	STRUCTURE ONLY	9990
<b>SEK ART. 0744</b>	B01 Ø cm 80	25707

SHIPMENT DETAILS	TECHNICAL SPECIFICATIONS	RESISTANCE TEST
<b>Art. 0744</b> 1 pz = 2  - kg 85,85/ m² 1,173		
<b>FIRE RETARDANT TEST</b>		

Frame Base



V12 V39  
glossy matt

Top



B01







# Dizzie

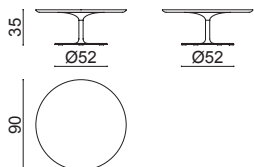

Design by Lievore Altherr Molina, 2014

Table with round base in white glossy or black matt powder coated steel, round top in white embossed MDF (Thick 2,5 cm) or laminate Fenix ® (Thick 2,6 cm). Height 35 cm.



Ø cm. 52  
Ø 20 1/2"

	Top	
<b>SEK ART. 0740</b>	STRUCTURE ONLY	9990
<b>SEK ART. 0720</b>	MDF MD Ø cm 90 	14812
<b>SEK ART. 0721</b>	Fenix ® Ø cm 90 	17932

SHIPMENT DETAILS	TECHNICAL SPECIFICATIONS	RESISTANCE TEST
<b>Art. 0720</b> 1 pz = 2  - kg 40,23/ m³ 0,242 <b>Art. 0721</b> 1 pz = 2  - kg 49,23/ m³ 0,24 <b>Art. 0740</b> 1 pz = 1  - kg 26,23/ m³ 0,152		
<b>FIRE RETARDANT TEST</b>		

Frame Base



V12 V39  
glossy matt

Top

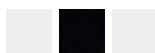

F01 F02 M02  
Fenix Fenix



Top shape edge



# Dizzie

Design by Lievore Altherr Molina, 2004

Table with oval base in white glossy or black matt powder coated steel, top in white embossed MDF (Thick 2,5 cm) or laminate Fenix ® (Thick 2,6 cm), available in different sizes. Height 35 cm.

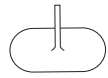
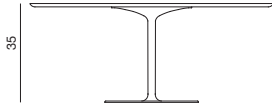

cm. 52 x 40.6  
20 1/2" x 16 1/8"

	Top		
<b>SEK ART. 0678</b>	STRUCTURE ONLY		7490
<b>SEK ART. 0636</b>	Fenix ® cm 90x108		14444
<b>SEK ART. 0688</b>	MDF MD cm 135x100		14670
<b>SEK ART. 0689</b>	MDF MD cm 90x108		12563

SHIPMENT DETAILS	TECHNICAL SPECIFICATIONS	RESISTANCE TEST
<p><b>Art. 0636</b> 1 pz = 2  - kg 40,8/ m³ 0,243</p> <p><b>Art. 0678</b> 1 pz = 1  - kg 24,5/ m³ 0,135</p> <p><b>Art. 0688</b> 1 pz = 2  - kg 48,7/ m³ 0,282</p> <p><b>Art. 0689</b> 1 pz = 2  - kg 43/ m³ 0,243</p>	<p><b>Art.0688</b> *Classe 1, 2, 1IM: fire retardant version available with surcharge and eventual minimum batch</p> <p><b>Art.0689</b> *Classe 1, 2, 1IM: fire retardant version available with surcharge and eventual minimum batch</p>	<ul style="list-style-type: none"> <li>• EN 717-2:1994 mgHCHO/(m2 - h) = 0,6</li> </ul>
<b>FIRE RETARDANT TEST</b>		

Frame Base



V12 V39  
glossy matt

Top

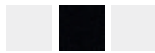

F01 F02 M02  
Fenix Fenix



Top shape edge







# Dizzie

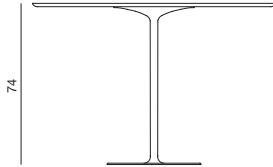



Design by Lievore Altherr Molina, 2004

Table with round base in white glossy or black matt powder coated steel, top in white embossed MDF (Thick 2,5 cm) or laminate Fenix ® (Thick 2,6 cm), available in different shapes and sizes (round, square). Height 74 cm.



Ø cm. 46  
Ø 18 1/8"

	Top	
<b>SEK ART. 0672</b>	STRUCTURE ONLY	7490
<b>SEK ART. 0657</b>	MDF MD ø cm 80 	10765
<b>SEK ART. 0660</b>	MDF MD cm 80x80 	10765
<b>SEK ART. 0694</b>	Fenix ® ø cm 79 	12383
<b>SEK ART. 0697</b>	Fenix ® cm 79x79 	12383

SHIPMENT DETAILS	TECHNICAL SPECIFICATIONS	RESISTANCE TEST
<b>Art. 0657</b> 1 pz = 2  - kg 34/ m³ 0,285 <b>Art. 0660</b> 1 pz = 2  - kg 36,5/ m³ 0,285 <b>Art. 0672</b> 1 pz = 1  - kg 23,5/ m³ 0,243 <b>Art. 0694</b> 1 pz = 2  - kg 34/ m³ 0,285 <b>Art. 0697</b> 1 pz = 2  - kg 36,5/ m³ 0,285	<b>Art.0657</b> *Classe 1, 2, 11M: fire retardant version available with surcharge and eventual minimum batch <b>Art.0660</b> *Classe 1, 2, 11M: fire retardant version available with surcharge and eventual minimum batch	• EN 717-2:1994 mgHCHO/(m2 - h) = 0,6
<b>FIRE RETARDANT TEST</b>		

Frame Base



V12 V39  
glossy matt

Top



F01 F02 M02  
Fenix Fenix



Top shape edge



# Dizzie

Design by Lievore Altherr Molina, 2018

Table with white coated steel round base. White polished Italian marble round top (2 cm thick). Height: 73,5 cm.

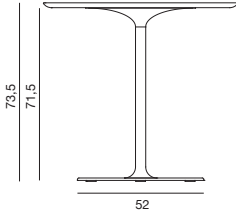

	Top	
<b>SEK ART. 0748</b>	STRUCTURE ONLY	10514
<b>SEK ART. 0745</b>	B01 Ø cm 80	26231

SHIPMENT DETAILS	TECHNICAL SPECIFICATIONS	RESISTANCE TEST
<b>Art. 0745</b> 1 pz = 2  - kg 91,07/ m² 1,313		
<b>FIRE RETARDANT TEST</b>		

Frame Base



V12 V39  
glossy matt

Top



B01



# Dizzie





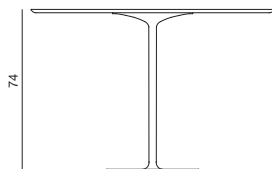

Design by Lievore Altherr Molina, 2014









Table with round base in white glossy or black matt powder coated steel, top in white embossed MDF (Thick 2,5 cm) or laminate Fenix ® (Thick 2,6 cm), available in different sizes. Height 74 cm.



Ø cm. 52  
Ø 20 1/2"

	Top	
<b>SEK ART. 0739</b>	STRUCTURE ONLY	10514
<b>SEK ART. 0707</b>	MDF MD Ø cm 90 	15336
<b>SEK ART. 0708</b>	Fenix ® Ø cm 90 	18456
<b>SEK ART. 0709</b>	MDF MD Ø cm 100 	15908
<b>SEK ART. 0710</b>	Fenix ® Ø cm 100 	19802
<b>SEK ART. 0711</b>	MDF MD Ø cm 120 	18111
<b>SEK ART. 0712</b>	Fenix ® Ø cm 120 	23790

SHIPMENT DETAILS	TECHNICAL SPECIFICATIONS	RESISTANCE TEST
<b>Art. 0707</b> 1 pz = 2  - kg 44,64/ m³ 0,38 <b>Art. 0708</b> 1 pz = 2  - kg 53,64/ m³ 0,378 <b>Art. 0709</b> 1 pz = 2  - kg 47,64/ m³ 0,397 <b>Art. 0710</b> 1 pz = 2  - kg 55,64/ m³ 0,397 <b>Art. 0711</b> 1 pz = 2  - kg 58,64/ m³ 0,44 <b>Art. 0712</b> 1 pz = 2  - kg 58,64/ m³ 0,44 <b>Art. 0739</b> 1 pz = 1  - kg 30,64/ m³ 0,29		
<b>FIRE RETARDANT TEST</b>		

Frame Base



V12 V39  
glossy matt

Top



F01 F02 M02  
Fenix Fenix



Top shape edge



# Dizzie





Design by Lievore Altherr Molina, 2004

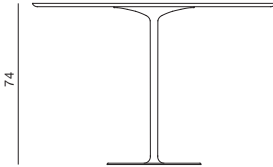







Table with round base base in white glossy or black matt powder coated steel, top in white embossed MDF (Thick 2,5 cm) or laminate Fenix ® (Thick 2,6 cm) available in round shapes and sizes. Height 74 cm.



Ø cm. 60  
Ø 23 5/8"

	Top	
<b>SEK ART. 0679</b>	STRUCTURE ONLY	11955
<b>SEK ART. 0634</b>	Fenix ® ø cm 158 (F01 - F02) 	30852
<b>SEK ART. 0635</b>	Fenix ® ø cm 134 (F01 - F02) 	25125
<b>SEK ART. 0690</b>	MDF MD ø cm 134 	20850
<b>SEK ART. 0691</b>	MDF MD ø cm 160 	25625

SHIPMENT DETAILS	TECHNICAL SPECIFICATIONS	RESISTANCE TEST
<p><b>Art. 0634</b> 1 pz = 3  - kg 94,6/ m³ 0,942</p> <p><b>Art. 0635</b> 1 pz = 3  - kg 81,8/ m³ 0,857</p> <p><b>Art. 0679</b> 1 pz = 2  - kg 51,6/ m³ 0,41</p> <p><b>Art. 0690</b> 1 pz = 3  - kg 81,8/ m³ 0,857</p> <p><b>Art. 0691</b> 1 pz = 3  - kg 94,6/ m³ 0,942</p> <p></p>	<p><b>Art.0690</b> *Classe 1, 2, 11M: fire retardant version available with surcharge and eventual minimum batch</p> <p><b>Art.0691</b> *Classe 1, 2, 11M: fire retardant version available with surcharge and eventual minimum batch</p>	
<b>FIRE RETARDANT TEST</b>		

Frame Base



V12 V39  
glossy matt

Top



F01 F02 M02  
Fenix Fenix



Top shape edge



# Dizzie







Design by Lievore Altherr Molina, 2004









Table with oval base in white glossy or black matt powder coated steel, top in white embossed MDF (Thick 2,5 cm) or laminate Fenix ® (Thick 2,6 cm), available in different shapes and sizes (oval, round, square). Height 74 cm.



cm. 52 x 40.6  
20 1/2" x 16 1/8"

	Top	
<b>SEK ART. 0671</b>	STRUCTURE ONLY	7490
<b>SEK ART. 0642</b>	Fenix ® cm 90x108 	14444
<b>SEK ART. 0653</b>	MDF MD cm 90x108 	12563
<b>SEK ART. 0656</b>	MDF MD ø cm 80 	10765
<b>SEK ART. 0659</b>	MDF MD cm 80x80 	10765
<b>SEK ART. 0693</b>	Fenix ® ø cm 79 	12383
<b>SEK ART. 0696</b>	Fenix ® cm 79x79 	12383

SHIPMENT DETAILS	TECHNICAL SPECIFICATIONS	RESISTANCE TEST
<p><b>Art. 0642</b> 1 pz = 2  - kg 40,3/ m³ 0,351</p> <p><b>Art. 0653</b> 1 pz = 2  - kg 42,5/ m³ 0,351</p> <p><b>Art. 0656</b> 1 pz = 2  - kg 34,5/ m³ 0,285</p> <p><b>Art. 0659</b> 1 pz = 2  - kg 37/ m³ 0,285</p> <p><b>Art. 0671</b> 1 pz = 1  - kg 24/ m³ 0,243</p> <p><b>Art. 0693</b> 1 pz = 2  - kg 34,5/ m³ 0,285</p> <p><b>Art. 0696</b> 1 pz = 2  - kg 37/ m³ 0,285</p>	<p><b>Art.0653</b> *Classe 1, 2, 1IM: fire retardant version available with surcharge and eventual minimum batch</p> <p><b>Art.0656</b> *Classe 1, 2, 1IM: fire retardant version available with surcharge and eventual minimum batch</p> <p><b>Art.0659</b> *Classe 1, 2, 1IM: fire retardant version available with surcharge and eventual minimum batch</p>	<ul style="list-style-type: none"> <li>• EN 717-2:1994 mgHCHO/(m2 - h) = 0,6</li> </ul>
<b>FIRE RETARDANT TEST</b>		

Frame Base



V12 V39  
glossy matt

Top

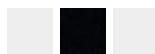

F01 F02 M02  
Fenix Fenix



Top shape edge







# Dizzie

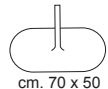
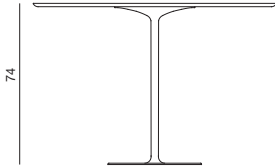



Design by Lievore Altherr Molina, 2004

Table with oval base in white glossy or black matt powder coated steel, oval top in white embossed MDF (Thick 2,5 cm) or laminate Fenix ® (Thick 2,6 cm). Height 74 cm.



cm. 70 x 50  
27 1/2" x 19 5/8"

	Top	
<b>SEK ART. 0670</b>	STRUCTURE ONLY	12288
<b>SEK ART. 0643</b>	Fenix ® cm 100x182 	24861
<b>SEK ART. 0651</b>	MDF MD cm 100x182 	21612
<b>SEK ART. 0652</b>	MDF MD cm 100x160 	20659
<b>SEK ART. 0692</b>	Fenix ® cm 100x158 	23766
<b>SEK ART. 0902</b>	MDF MD cm 100x135 	19468

SHIPMENT DETAILS	TECHNICAL SPECIFICATIONS	RESISTANCE TEST
<p><b>Art. 0643</b> 1 pz = 3  - kg 83,6/ m³ 0,852</p> <p><b>Art. 0651</b> 1 pz = 3  - kg 83,6/ m³ 0,852</p> <p><b>Art. 0652</b> 1 pz = 3  - kg 79,6/ m³ 0,831</p> <p><b>Art. 0670</b> 1 pz = 2  - kg 49,6/ m³ 0,41</p> <p><b>Art. 0692</b> 1 pz = 3  - kg 79,6/ m³ 0,831</p>	<p><b>Art.0651</b> *Classe 1, 2, 11M: fire retardant version available with surcharge and eventual minimum batch</p> <p><b>Art.0652</b> *Classe 1, 2, 11M: fire retardant version available with surcharge and eventual minimum batch</p>	<ul style="list-style-type: none"> <li>• EN 717-2:1994 mgHCHO/(m2 - h) = 0,6</li> </ul>
<b>FIRE RETARDANT TEST</b>		

Frame Base



Top

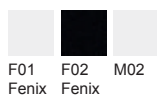

Top shape edge





# Dizzie

Design by Lievore Altherr Molina, 2004



Table with square base in white glossy or black matt powder coated steel, top in white embossed MDF (Thick 2,5 cm) or laminate Fenix ® (Thick 2,6 cm), available in different sizes. Height 74 cm.



cm. 43 x 43  
16 7/8" x 16 7/8"

	Top	
<b>SEK ART. 0673</b>	STRUCTURE ONLY	7490
<b>SEK ART. 0661</b>	MDF MD cm 80x80 <input type="checkbox"/>	10765
<b>SEK ART. 0698</b>	Fenix ® cm 79x79 <input type="checkbox"/>	12383

SHIPMENT DETAILS	TECHNICAL SPECIFICATIONS	RESISTANCE TEST
<b>Art. 0661</b> 1 pz = 2  - kg 37,6/ m³ 0,285 <b>Art. 0673</b> 1 pz = 1  - kg 24,6/ m³ 0,243 <b>Art. 0698</b> 1 pz = 2  - kg 37,6/ m³ 0,285	<b>Art.0661</b> *Classe 1, 2, 11M: fire retardant version available with surcharge and eventual minimum batch	
<b>FIRE RETARDANT TEST</b>		

Frame Base



V12 V39  
glossy matt

Top



F01 F02 M02  
Fenix Fenix



Top shape edge



# Dizzie





Design by Lievore Altherr Molina, 2004







Table with round base in white glossy or black matt powder coated steel, top in white embossed MDF (Thick 2,5 cm) or laminate Fenix® (Thick 2,6 cm), , available in different shapes and sizes (square, round). Height 105 cm.



Ø cm. 46  
Ø 18 1/8"

	Top	
<b>SEK ART. 0675</b>	STRUCTURE ONLY	7846
<b>SEK ART. 0646</b>	Fenix cm 79x79 	12739
<b>SEK ART. 0647</b>	Fenix ø cm 79 	12739
<b>SEK ART. 0684</b>	MDF MD ø cm 80 	11121
<b>SEK ART. 0685</b>	MDF MD cm 80x80 	11121

SHIPMENT DETAILS	TECHNICAL SPECIFICATIONS	RESISTANCE TEST
<p><b>Art. 0646</b> 1 pz = 2  - kg 39,5/ m³ 0,337</p> <p><b>Art. 0647</b> 1 pz = 2  - kg 37/ m³ 0,337</p> <p><b>Art. 0675</b> 1 pz = 1  - kg 26,5/ m³ 0,295</p> <p><b>Art. 0684</b> 1 pz = 2  - kg 37/ m³ 0,337</p> <p><b>Art. 0685</b> 1 pz = 2  - kg 39,5/ m³ 0,337</p>	<p><b>Art.0684</b> *Classe 1, 2, 1IM: fire retardant version available with surcharge and eventual minimum batch</p> <p><b>Art.0685</b> *Classe 1, 2, 1IM: fire retardant version available with surcharge and eventual minimum batch</p>	<ul style="list-style-type: none"> <li>• EN 717-2:1994 mgHCHO/(m2 - h) = 0,6</li> </ul>
<b>FIRE RETARDANT TEST</b>		

Frame Base



V12 V39  
glossy matt

Top

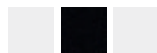

F01 F02 M02  
Fenix Fenix



Top shape edge





# Dizzie



Design by Lievore Altherr Molina, 2004

Table with oval base in white glossy or black matt powder coated steel, top in white embossed MDF (Thick 2,5 cm) or laminate Fenix ® (Thick 2,6 cm), available in different sizes. Height 105 cm.



cm. 52 x 40.6  
20 1/2" x 16 1/8"

	Top	
<b>SEK ART. 0674</b>	STRUCTURE ONLY	7846
<b>SEK ART. 0649</b>	Fenix ® ø cm 79 	12739
<b>SEK ART. 0682</b>	MDF MD ø cm 80 	11121

SHIPMENT DETAILS	TECHNICAL SPECIFICATIONS	RESISTANCE TEST
<b>Art. 0649</b> 1 pz = 2  - kg 37/ m³ 0,337 <b>Art. 0674</b> 1 pz = 1  - kg 27,5/ m³ 0,295 <b>Art. 0682</b> 1 pz = 2  - kg 38/ m³ 0,337	<b>Art.0682</b> *Classe 1, 2, 11M: fire retardant version available with surcharge and eventual minimum batch	• EN 717-2:1994 mgHCHO/(m2 - h) = 0,6
<b>FIRE RETARDANT TEST</b>		

Frame Base



V12 V39  
glossy matt

Top

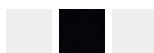

F01 F02 M02  
Fenix Fenix



Top shape edge



# FRED

Design by Jean-Marie Massaud

2007



# Fred

## Collection overview

### Type



h 36,4 cm

h 50 cm

h 74 cm

h 105 cm

### Base



		h 36,4 cm	h 50 cm	h 74 cm	h 105 cm
Round top	Ø 65 cm	*	*	*	*
	Ø 80 cm	*	*	*	*
Square top	60x60 cm	*	*	*	*
	70x70 cm	*	*	*	*
	80x80 cm	*		*	

### Top finishes

— MDF

# Fred





Design by Jean-Marie Massaud, 2007

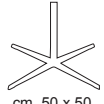
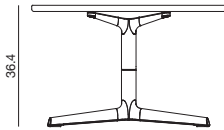







Table with four-star base in polished or powder-coated aluminium and top in white, embossed MDF (Thick 1,9 cm), available in different shapes and sizes (square, round). Height 36.4 cm.



cm. 50 x 50  
19 5/8" x 19 5/8"

	Top	POLISHED ALUMINIUM / POWDERCOATED
<b>SEK ART. 0950</b>	STRUCTURE ONLY	4346
<b>SEK ART. 0960</b>	MDF MD cm 60x60 	5727
<b>SEK ART. 0961</b>	MDF MD cm 70x70 	6037
<b>SEK ART. 0962</b>	MDF MD ø cm 80 	6192
<b>SEK ART. 0963</b>	MDF MD cm 80x80 	6192
<b>SEK ART. 0976</b>	MDF MD ø cm 65 	5787

SHIPMENT DETAILS	TECHNICAL SPECIFICATIONS	RESISTANCE TEST
<b>Art. 0950</b> 1 pz = 1  - kg 4,5/ m³ 0,118 <b>Art. 0960</b> 1 pz = 2  - kg 12,1/ m³ 0,205 <b>Art. 0961</b> 1 pz = 2  - kg 14,1/ m³ 0,218 <b>Art. 0962</b> 1 pz = 2  - kg 15/ m³ 0,234 <b>Art. 0963</b> 1 pz = 2  - kg 17,5/ m³ 0,234 <b>Art. 0976</b> 1 pz = 2  - kg 12,1/ m³ 0,212	<b>Art.0960</b> *Classe 1, 2, 11M: fire retardant version available with surcharge and eventual minimum batch  <b>Art.0961</b> *Classe 1, 2, 11M: fire retardant version available with surcharge and eventual minimum batch  <b>Art.0962</b> *Classe 1, 2, 11M: fire retardant version available with surcharge and eventual minimum batch  <b>Art.0963</b> *Classe 1, 2, 11M: fire retardant version available with surcharge and eventual minimum batch	
<b>FIRE RETARDANT TEST</b>		

Frame Base



LU1 V12  
matt

Top



M02



Top shape edge



# Fred

Design by Jean-Marie Massaud, 2007

Table with four-star base in polished or powder-coated aluminium and top in white, embossed MDF (Thick 1,9 cm), available in different shapes and sizes (square, round). Height 50 cm.

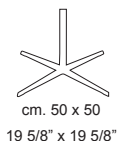
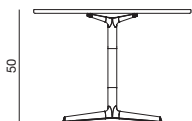

	Top		POLISHED ALUMINIUM / POWDERCOATED
<b>SEK ART. 0953</b>	STRUCTURE ONLY		5502
<b>SEK ART. 0972</b>	MDF MD cm 60x60		6883
<b>SEK ART. 0973</b>	MDF MD cm 70x70		7193
<b>SEK ART. 0975</b>	MDF MD ø cm 80		7348
<b>SEK ART. 0977</b>	MDF MD ø cm 65		6943

SHIPMENT DETAILS	TECHNICAL SPECIFICATIONS	RESISTANCE TEST
<b>Art. 0953</b> 1 pz = 1  - kg 5,5/ m³ 0,118 <b>Art. 0972</b> 1 pz = 2  - kg 11,8/ m³ 0,254 <b>Art. 0973</b> 1 pz = 2  - kg 15,1/ m³ 0,266 <b>Art. 0975</b> 1 pz = 2  - kg 15/ m³ 0,283 <b>Art. 0977</b> 1 pz = 2  - kg 13,1/ m³ 0,26	<b>Art.0972</b> *Classe 1, 2, 11M: fire retardant version available with surcharge and eventual minimum batch  <b>Art.0973</b> *Classe 1, 2, 11M: fire retardant version available with surcharge and eventual minimum batch	
<b>FIRE RETARDANT TEST</b>		

Frame Base



LU1 V12  
matt

Top



M02



Top shape edge



# Fred

Design by Jean-Marie Massaud, 2007

Table with four-star base in polished or powder-coated aluminium and top in white, embossed MDF (Thick 1,9 cm), available in different shapes and sizes (square, round). Height 74 cm.

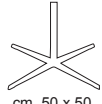
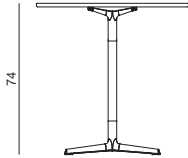

cm. 50 x 50  
19 5/8" x 19 5/8"

	Top	POLISHED ALUMINIUM / POWDERCOATED
<b>SEK ART. 0951</b>	STRUCTURE ONLY	5917
<b>SEK ART. 0964</b>	MDF MD cm 60x60 <input type="checkbox"/>	7298
<b>SEK ART. 0965</b>	MDF MD cm 70x70 <input type="checkbox"/>	7608
<b>SEK ART. 0966</b>	MDF MD ø cm 80 <input type="radio"/>	7763
<b>SEK ART. 0967</b>	MDF MD cm 80x80 <input type="checkbox"/>	7763
<b>SEK ART. 0978</b>	MDF MD ø cm 65 <input type="radio"/>	7358

SHIPMENT DETAILS	TECHNICAL SPECIFICATIONS	RESISTANCE TEST
<b>Art. 0951</b> 1 pz = 1  - kg 5,5/ m³ 0,122 <b>Art. 0964</b> 1 pz = 2  - kg 13,1/ m³ 0,31 <b>Art. 0965</b> 1 pz = 2  - kg 15,1/ m³ 0,323 <b>Art. 0966</b> 1 pz = 2  - kg 16/ m³ 0,339 <b>Art. 0967</b> 1 pz = 2  - kg 18,5/ m³ 0,339 <b>Art. 0978</b> 1 pz = 2  - kg 13,1/ m³ 0,316	<b>Art.0964</b> *Classe 1, 2, 11M: fire retardant version available with surcharge and eventual minimum batch <b>Art.0965</b> *Classe 1, 2, 11M: fire retardant version available with surcharge and eventual minimum batch <b>Art.0966</b> *Classe 1, 2, 11M: fire retardant version available with surcharge and eventual minimum batch <b>Art.0967</b> *Classe 1, 2, 11M: fire retardant version available with surcharge and eventual minimum batch	
<b>FIRE RETARDANT TEST</b>		

Frame Base



LU1 V12  
matt

Top



M02



Top shape edge





# Fred

Design by Jean-Marie Massaud, 2007

Table with four-star base in polished or powder-coated aluminium and top in white, embossed MDF (Thick 1,9 cm), available in different shapes and sizes (square, round). Height 105 cm.



	Top		POLISHED ALUMINIUM / POWDERCOATED
<b>SEK ART. 0952</b>	STRUCTURE ONLY		6287
<b>SEK ART. 0969</b>	MDF MD cm 60x60		7668
<b>SEK ART. 0970</b>	MDF MD cm 70x70		7978
<b>SEK ART. 0971</b>	MDF MD ø cm 80		8133
<b>SEK ART. 0979</b>	MDF MD ø cm 65		7728

SHIPMENT DETAILS	TECHNICAL SPECIFICATIONS	RESISTANCE TEST
<b>Art. 0952</b> 1 pz = 1  - kg 7/ m³ 0,128 <b>Art. 0969</b> 1 pz = 2  - kg 14,6/ m³ 0,456 <b>Art. 0970</b> 1 pz = 2  - kg 16,6/ m³ 0,469 <b>Art. 0971</b> 1 pz = 2  - kg 17,5/ m³ 0,485 <b>Art. 0979</b> 1 pz = 2  - kg 14,6/ m³ 0,462	<b>Art.0969</b> *Classe 1, 2, 11M: fire retardant version available with surcharge and eventual minimum batch <b>Art.0970</b> *Classe 1, 2, 11M: fire retardant version available with surcharge and eventual minimum batch <b>Art.0971</b> *Classe 1, 2, 11M: fire retardant version available with surcharge and eventual minimum batch	
<b>FIRE RETARDANT TEST</b>		

Frame Base

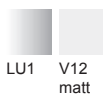

Top



Top shape edge



# GHIA

Design by  
Altherr Désile Park  
2022

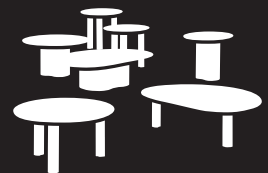

# Ghia

## Collection overview

---

### 3-leg base



h 30 cm



h 37,5 cm



h 45 cm

---

### Central Base



h 30 cm



h 37,5 cm



h 45 cm

---

		MDF			Wood			Terrazzo
		h 30 cm	h 37,5 cm	h 45 cm	h 30 cm	h 37,5 cm	h 45 cm	h 45 cm
Round Top	Ø 50 cm			*			*	*
	Ø 70 cm		*			*		
Organically shaped top	105 x 74 cm	*			*			

Top finishes:

- MDF
- Wood
- Venetian terrazzo

# Ghia

Design by Altherr Désile Park, 2022

Coffee table with a 3-leg base, available in three heights: 30, 37.5 or 45 cm. Round or organically shaped top in three sizes (2 cm thick). Coated MDF base and top, available in a single-colour combination.



<p><b>ART. 7000</b></p>	<p><b>ART. 7001</b></p>	<p><b>ART. 7002</b></p>
-------------------------	-------------------------	-------------------------

	Top	
<b>SEK ART.7000</b>	Ø 50 cm h 45 cm	6113
<b>SEK ART.7001</b>	Ø 70 h 37,5 cm	7111
<b>SEK ART.7002</b>	74 x 105 cm h 30 cm	8732

SHIPMENT DETAILS	TECHNICAL SPECIFICATIONS	RESISTANCE TEST
<p><b>Art. 7000</b> 1 pz = 2  - kg 8,975/ m³ 0,054</p> <p><b>Art. 7001</b> 1 pz = 2  - kg 12,159/ m³ 0,044</p> <p><b>Art. 7002</b> 1 pz = 2  - kg 16,429/ m³ 0,062</p> <p></p>		
<b>FIRE RETARDANT TEST</b>		

Frame Base



Top

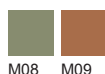

# Ghia

Design by Altherr Désile Park, 2022

Coffee table with a 3-leg base, available in three heights: 30, 37.5 or 45 cm. Round or organically shaped top in three sizes (2 cm thick). Base and top in oak veneered MDF, available in a single-colour combination.



ART. 7006	ART. 7007	ART. 7008
	Top	
<b>SEK ART.7006</b>	Ø 50 cm h 45 cm	8426
<b>SEK ART.7007</b>	Ø 70 h 37,5 cm	10104
<b>SEK ART.7008</b>	74 x 105 cm h 30 cm	13098

SHIPMENT DETAILS	TECHNICAL SPECIFICATIONS	RESISTANCE TEST
<p><b>Art. 7006</b> 1 pz = 2  - kg 8,975/ m³ 0,029</p> <p><b>Art. 7008</b> 1 pz = 2  - kg 16,429/ m³ 0,071</p> <p></p>		<ul style="list-style-type: none"> <li>• EN 1730:2012 - EN 15372:2016 5.1-5.2</li> <li>• EN 1730:2012 - EN 15372:2016 6.3</li> <li>• EN 1730:2012 - EN 15372:2016 6.6</li> <li>• EN 1730:2012 - EN 15372:2016 6.2</li> <li>• EN 1730:2012 - EN 15372:2016 6.4.2</li> </ul>
<b>FIRE RETARDANT TEST</b>		

Frame Base



Top



# Ghia

Design by Altherr Désile Park, 2022

H. 45 cm coffee table with a 3-leg base in oak veneered MDF. Venetian Terrazzo top, round (2 cm thick).

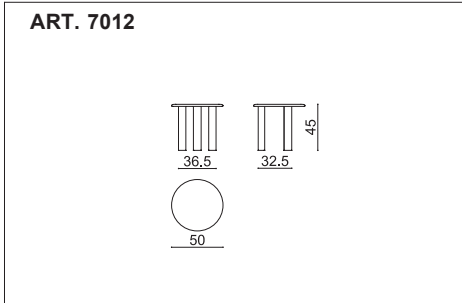

	Top	
<b>SEK ART.7012</b>	Ø 50 cm h 45 cm	12224

SHIPMENT DETAILS	TECHNICAL SPECIFICATIONS	RESISTANCE TEST
<b>Art. 7012</b> 1 pz = 2  - kg 14,973/ m³ 0,029 		
<b>FIRE RETARDANT TEST</b>		

Frame Base



Top

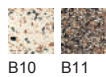

# Ghia

Design by Altherr Désile Park, 2022

Coffee table with a central base in oak veneered MDF, available in three heights: 30, 37.5 or 45 cm. Round or organically shaped top in powercoated MDF, in three sizes (2 cm thick). The base and top finishes can be freely combined.



ART. 7003	ART. 7004	ART. 7005
	Top	
<b>SEK ART.7003</b>	Ø 50 cm h 45 cm	9028
<b>SEK ART.7004</b>	Ø 70 h 37,5 cm	10026
<b>SEK ART.7005</b>	74 x 105 cm h 30 cm	11647

SHIPMENT DETAILS	TECHNICAL SPECIFICATIONS	RESISTANCE TEST
<b>Art. 7003</b> 1 pz = 2  - kg 15,622/ m³ 0,055 <b>Art. 7004</b> 1 pz = 2  - kg 23,4/ m³ 0,078 <b>Art. 7005</b> 1 pz = 2  - kg 20,746/ m³ 0,12 		<ul style="list-style-type: none"> <li>• EN 1730:2012 - EN 15372:2016 5.1-5.2</li> <li>• EN 1730:2012 - EN 15372:2016 6.3</li> <li>• EN 1730:2012 - EN 15372:2016 6.5</li> <li>• EN 1730:2012 - EN 15372:2016 6.2</li> <li>• EN 1730:2012 - EN 15372:2016 6.4.2</li> <li>• EN 1730:2012 - EN 15372:2016 6.6</li> </ul>
<b>FIRE RETARDANT TEST</b>		

Frame Base



L0006 L0022

Top



M08 M09



# Ghia

Design by Altherr Désile Park, 2022

Coffee table with a central base, available in three heights: 30, 37.5 or 45 cm. Round or organically shaped top in three sizes (2 cm thick). Base and top in oak veneered MDF, available in a single-colour combination.



<p><b>ART. 7009</b></p>	<p><b>ART. 7010</b></p>	<p><b>ART. 7011</b></p>
-------------------------	-------------------------	-------------------------

	Top	
<b>SEK ART.7009</b>	Ø 50 cm h 45 cm	11341
<b>SEK ART.7010</b>	Ø 70 h 37,5 cm	13019
<b>SEK ART.7011</b>	74 x 105 cm h 30 cm	16013

SHIPMENT DETAILS	TECHNICAL SPECIFICATIONS	RESISTANCE TEST
<p><b>Art. 7009</b> 1 pz = 2  - kg 15,622/ m³ 0,054</p> <p><b>Art. 7010</b> 1 pz = 2  - kg 23,4/ m³ 0,078</p> <p><b>Art. 7011</b> 1 pz = 2  - kg 20,746/ m³ 0,12</p> <p></p>		<ul style="list-style-type: none"> <li>• EN 1730:2012 - EN 15372:2016 5.1-5.2</li> <li>• EN 1730:2012 - EN 15372:2016 6.3</li> <li>• EN 1730:2012 - EN 15372:2016 6.5</li> <li>• EN 1730:2012 - EN 15372:2016 6.2</li> <li>• EN 1730:2012 - EN 15372:2016 6.4.2</li> <li>• EN 1730:2012 - EN 15372:2016 6.6</li> </ul>
<b>FIRE RETARDANT TEST</b>		

Frame Base



Top

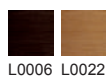



# Ghia

Design by Altherr Désile Park, 2022

H. 45 cm coffee table with a central base in oak veneered MDF. Venetian Terrazzo top, round (2 cm thick).

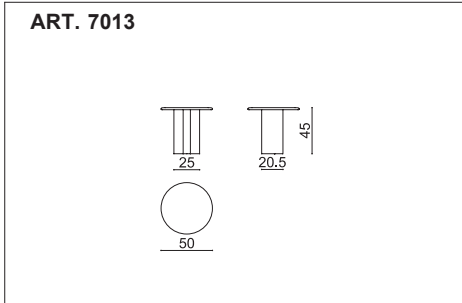

	Top	
<b>SEK ART.7013</b>	Ø 50 cm h 45 cm	15139

SHIPMENT DETAILS	TECHNICAL SPECIFICATIONS	RESISTANCE TEST
<b>Art. 7013</b> 1 pz = 2  - kg 21,62/ m² 0,055 		
<b>FIRE RETARDANT TEST</b>		

Frame Base



Top



# LEAF TABLE

Design by  
Lievore Altherr Molina  
2011



# Leaf Table

Collection overview  
Available in the Tables section

## Type



h 50 cm



h 74 cm









h 74 cm



h 74 cm

## Base

					
		h 50 cm	h 74 cm	h 74 cm	h 74 cm
Top		Ø 79 cm			
			Ø 79 cm	Ø 100 cm	
					79x79 cm

## Top finishes

— HPL



Outdoor

# Leaf Chair

## Collection overview

Available in the Chairs and Stools section

### Type



Sled



Stackable sled



Lounge sled



Counter stool sled



Bar stool sled

Seat cushions are available



Outdoor



# Leaf Table

Design by Lievore Altherr Molina, 2011



Table with steel base and triangular top with rounded edges, made of Compact HPL. Powder-coated base available in white, moka and green, while top is only available in dark grey (thick 1,2 cm). Suitable for outdoor use. Height 50 cm. Collection includes, coordinated with table, several models of chair. (Leaf Chair, Pricelist I)

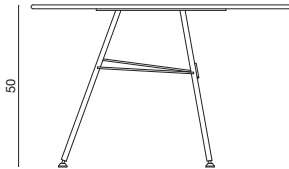

	Top		POWDERCOATED
<b>SEK ART. 1813</b>	HPL inscribed ø cm 79		7568

SHIPMENT DETAILS	TECHNICAL SPECIFICATIONS	RESISTANCE TEST
<b>Art. 1813</b> 1 pz = 2  - kg 17,5/ m³ 0,25 		
<b>FIRE RETARDANT TEST</b>		

Frame Base

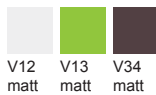

Top



Top shape edge



Outdoor use





# Leaf Table

Design by Lievore Altherr Molina, 2011

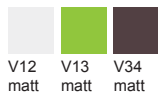

Table with steel base and round top made of solid core HPL. Powder-coated base available in white, moka and green, while top is only available in dark grey (thick 1,2 cm). Suitable for outdoor use. Height cm 74. Collection includes coordinated chairs. (Leaf Chair, Pricelist I)

	Top		POWDERCOATED
<b>SEK ART. 1814</b>	HPL ø cm 79		8111

SHIPMENT DETAILS	TECHNICAL SPECIFICATIONS	RESISTANCE TEST
<b>Art. 1814</b> 1 pz = 2  - kg 20,5/ m³ 0,43 		
<b>FIRE RETARDANT TEST</b>		

Frame Base



Top



Top shape edge



Outdoor use

# Leaf Table

Design by Lievore Altherr Molina, 2011

Table with steel base and round top made of Compact HPL. Powder-coated base available in white, moka and green, while top is only available in dark grey (thick 1,2 cm). Suitable for outdoor use. Height 74 cm. Collection includes, coordinated with tables, several models of chair (Leaf, Pricelist I).

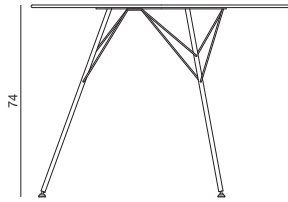

	Top		POWDERCOATED
<b>SEK ART. 1816</b>	HPL ø cm 100		12442

SHIPMENT DETAILS	TECHNICAL SPECIFICATIONS	RESISTANCE TEST
<b>Art. 1816</b> 1 pz = 2  - kg 25/ m³ 0,615 		
<b>FIRE RETARDANT TEST</b>		

Frame Base

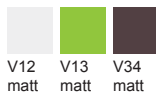

Top



Top shape edge



Outdoor use

# Leaf Table

Design by Lievore Altherr Molina, 2011

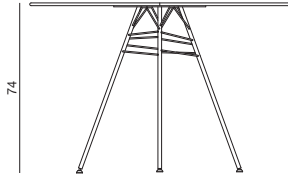
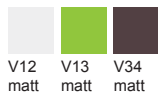

Table with steel base and square top made of Compact HPL. Powder-coated base available in white, moka and green, while top is only available in dark grey (thick 1,2 cm). Suitable for outdoor use. Height 74 cm. Collection includes, coordinated with tables, several models of chair (Leaf, Pricelist I).

	Top		POWDERCOATED
<b>SEK ART. 1815</b>	HPL cm 79x79	<input type="checkbox"/>	9202

SHIPMENT DETAILS	TECHNICAL SPECIFICATIONS	RESISTANCE TEST
<b>Art. 1815</b> 1 pz = 2  - kg 22,5/ m³ 0,369 		
<b>FIRE RETARDANT TEST</b>		

Frame Base



Top



Top shape edge



Outdoor use







# MEETY

---

Design by  
Lievore Altherr Molina  
2016

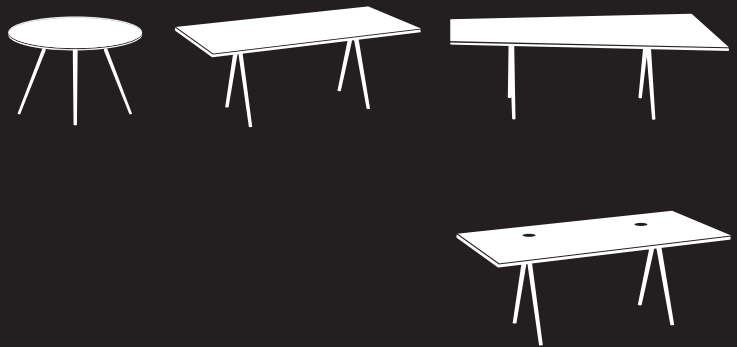

# Meety

## Collection overview

### Type



h 74 cm Round top







h 74 cm Rectangular top



h 74 cm Office



h 74 cm Trapezoidal top

 Round top	 Rectangular top	 Office	 Trapezoidal top
Ø 120 cm	69x139 cm		80/120x240 cm
	79x159 cm		
	79x179 cm		
	90x160 cm	90x160 cm	
	100x200 cm	100x200 cm	
	100x240 cm		

Actual top/finish dimensions are available in the price list.

### Top finishes

- Fenix®
- Veneered









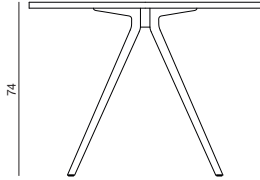

# Meety







Design by Lievore Altherr Molina, 2016



Table with top in white or black Fenix® laminate (Thick 2,4 cm), and legs in white or black powdercoated aluminum. Available in different shapes: round, rectangular or trapezoidal. Height 74 cm. For round options, the possibility of positioning the selected chairs under the table in full has to be verified based on the dimensions of the chair itself.



	Top	POWDERCOATED
  <b>SEK ART. 5453</b>	ø cm 119 	11657
 	<b>SEK ART. 5407</b> cm 69 x 139 	10609
	<b>SEK ART. 5409</b> cm 79 x 159 	11621
	<b>SEK ART. 5410</b> cm 79 x 179 	12287
	<b>SEK ART. 5411</b> cm 99 x 200 	14597
  <b>SEK ART. 5412</b>	cm 120 /80 x 240	19135

SHIPMENT DETAILS	RESISTANCE TEST
<b>Art. 5407</b> 1 pz = 3  - kg 36,61/ m² 0,126 <b>Art. 5409</b> 1 pz = 3  - kg 41,57/ m² 0,139 <b>Art. 5410</b> 1 pz = 3  - kg 45,27/ m² 0,152 <b>Art. 5411</b> 1 pz = 3  - kg 58,03/ m² 0,229 <b>Art. 5412</b> 1 pz = 3  - kg 68,08/ m² 0,309 <b>Art. 5453</b> 1 pz = 3  - kg 46,23/ m² 0,157	<ul style="list-style-type: none"> <li>• EN 1730:2012 - EN 15372:2016 5.1-5.2</li> <li>• EN 1730:2012 - EN 15372:2016 6.3</li> <li>• EN 1730:2012 - EN 15372:2016 6.5</li> <li>• EN 1730:2012 - EN 15372:2016 6.7</li> <li>• EN 1730:2012 - EN 15372:2016 6.4.3</li> </ul> <ul style="list-style-type: none"> <li>• EN 1730:2012 - EN 15372:2016 6.2</li> <li>• EN 1730:2012 - EN 15372:2016 6.4.2</li> <li>• EN 1730:2012 - EN 15372:2016 6.6</li> <li>• EN 1730:2012 - EN 15372:2016 6.9</li> <li>• EN 1730:2012 - EN 15372:2016 7.2</li> </ul>
TECHNICAL SPECIFICATIONS	
FIRE RETARDANT TEST	

Frame Base



Top

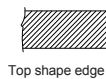
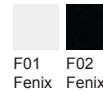

# Meety

Design by Lievore Altherr Molina, 2016

Table with top in natural oak veneered or wengé (Thick 3 cm) and legs in white or black powdercoated aluminium. Available in rectangular shapes. Height 74.5 cm.

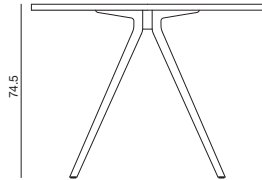

		Top	POWDERCOATED
	<b>SEK ART. 5431</b>	cm 90 x 160 <input type="checkbox"/>	18396
	<b>SEK ART. 5433</b>	cm 100 x 200 <input type="checkbox"/>	22301
	<b>SEK ART. 5434</b>	cm 100 x 240 <input type="checkbox"/>	25315
Legs configuration not perpendicular			+ 1095

SHIPMENT DETAILS	RESISTANCE TEST
<b>Art. 5431</b> 1 pz = 3  - kg 44,17/ m² 0,15 <b>Art. 5433</b> 1 pz = 3  - kg 56,64/ m² 0,229 <b>Art. 5434</b> 1 pz = 3  - kg 65,98/ m² 0,269	
	TECHNICAL SPECIFICATIONS
FIRE RETARDANT TEST	

Frame Base



Top

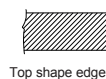
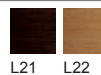







# Meety

Design by Lievore Altherr Molina, 2016



Table with top in natural oak veneered or wengé (Thick 3 cm) and legs in white or black powdercoated aluminium. Available in different shapes: round or trapezoidal. Height 74.5 cm. For round options, the possibility of positioning the selected chairs under the table in full has to be verified based on the dimensions of the chair itself.

	Top	POWDERCOATED
 	<b>SEK ART. 5455</b> ø cm 120	 19242
 	<b>SEK ART. 5437</b> cm 120/80 x 240	29673

<b>SHIPMENT DETAILS</b>	<b>RESISTANCE TEST</b>
<b>Art. 5437</b> 1 pz = 3  - kg 65,98/ m³ 0,309 <b>Art. 5455</b> 1 pz = 3  - kg 45,576/ m³ 0,157	
	<b>TECHNICAL SPECIFICATIONS</b>
<b>FIRE RETARDANT TEST</b>	

Frame Base



Top

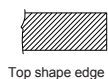
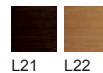

# Meety Office





Design by Lievore Altherr Molina, 2017



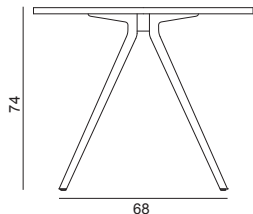

Office table with rectangular top, also available, if requested at the time of the order, with two optional openings ( to be used with cable grommet Art. 5466). Other office accessories complete the layout. Table is available with a white Fenix® laminate top and white powder-coated aluminum frame.

- Accessories:  
 Drawers chest Art. 0822  
 Modesty Panel Art. 5463  
 Vertical Cable Management Art. 5464  
 Cable tray Art. 5465  
 Grommets Art. 5466  
 Link Kit Art. 5467



	Top	POWDERCOATED
 	<b>SEK ART. 5460</b> cm 89 x 159	13062
 	<b>SEK ART. 5462</b> cm 99 x 200	14765
	Openings for cable grommet	✚ 619

<b>SHIPMENT DETAILS</b>	<b>RESISTANCE TEST</b>
<b>Art. 5460</b> 1 pz = 3  - kg 47,05/ m² 0,16 <b>Art. 5462</b> 1 pz = 3  - kg 59,14/ m² 0,235	
	<b>TECHNICAL SPECIFICATIONS</b>
<b>FIRE RETARDANT TEST</b>	

Frame Base





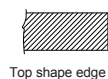





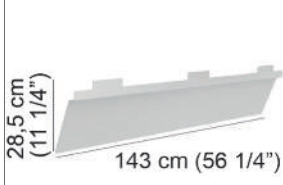

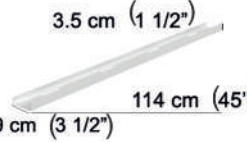
Top



# Accessories

Design by Lievore Altherr Molina, 2017

<p><b>SEK ART. 5463</b></p>  <p>28.5 cm (11 1/4") 143 cm (56 1/4")</p> <p>MODESTY PANEL</p> <p>1929</p>	<p><b>SEK ART. 5464</b></p>  <p>VERTICAL CABLE MANAGEMENT</p> <p>524</p>	<p><b>SEK ART. 5465</b></p>  <p>3.5 cm (1 1/2") 114 cm (45") 9 cm (3 1/2")</p> <p>CABLE TRAY</p> <p>1334</p>	<p><b>SEK ART. 5466</b></p>  <p>Ø9 cm (Ø3 1/2")</p> <p>GROMMETS</p> <p>548</p>	<p><b>SEK ART. 5467</b></p>  <p>LINK KIT FOR MEETY OFFICE TABLES</p> <p>941</p>
---	---	---	--	--

SHIPMENT DETAILS	TECHNICAL SPECIFICATIONS
<p><b>Art. 5463</b> 1 pz = 1  - kg 8,19/ m³ 0,045</p> <p><b>Art. 5465</b> 1 pz = 1  - kg 8,59/ m³ 0,03</p> <p><b>Art. 5467</b> 1 pz = 1  - kg 0,35/ m³ 0,004</p>	<p><b>Art. 5464</b> 1 pz = 1  - kg 0,14/ m³ 0,003</p> <p><b>Art. 5466</b> 1 pz = 1  - kg 0,43/ m³ 0,004</p>
<p><b>FIRE RETARDANT TEST</b></p>	

  
V12  
matt





# Accessories

Design by Simon Pengelly, 2009

## SEK ART. 0822



5777

SHIPMENT DETAILS	TECHNICAL SPECIFICATIONS	RESISTANCE TEST
FIRE RETARDANT TEST		



# NUUR

---

Design by  
Simon Pengelly  
2009



# Nuur



## Collection overview

### Type



h 74 cm Standard top

h 74 cm Office top

	 <b>Square</b>	 <b>Rectangulare</b>					
	79x79 cm	120x79 cm	160x79 cm	180x79 cm	180x90 cm	200x100 cm	240x100 cm
<b>Standard h 74 cm</b>	*	*	*	*	*	*	*
<b>Nuur Office h 74 cm</b>			*	*		*	

### Options and accessories



Drawers chest  
(3 drawers)

For further accessories please go at the end of the collection

### Top finishes

— Fenix®



# Nuur

Design by Simon Pengelly, 2009

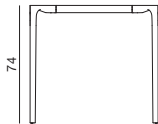
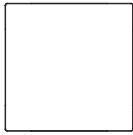
Table with laminated Fenix® square top and powder-coated aluminum frame. Height 74 cm.



	Top	FENIX	
<b>SEK ART. 0800</b>	cm 79x79 	14586	

SHIPMENT DETAILS	TECHNICAL SPECIFICATIONS	RESISTANCE TEST
<b>Art. 0800</b> 1 pz = 4  - kg 32,18/ m³ 0,208 		
<b>FIRE RETARDANT TEST</b>		

Frame Base



V12 matt V39 matt

Top

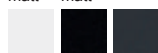

F01 Fenix F02 Fenix F06 Fenix

Fenix finishes F01, F02: delivery in 4 weeks from the order. Other Fenix colors: delivery in 8 weeks from the order.



# Nuur

Design by Simon Pengelly, 2009

Table with laminated Fenix® rectangular top and powder-coated aluminum frame. Height 74 cm.

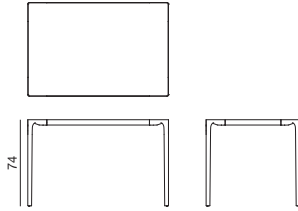

	Top		FENIX	
<b>SEK ART. 0801</b>	cm 120x79		19385	
<b>SEK ART. 0802</b>	cm 160x79		21326	
<b>SEK ART. 0803</b>	cm 180x90		25196	
<b>SEK ART. 0805</b>	cm 200x100		26434	
<b>SEK ART. 0806</b>	cm 240x100		32769	
<b>SEK ART. 0814</b>	cm 180x79		23505	

SHIPMENT DETAILS	TECHNICAL SPECIFICATIONS	RESISTANCE TEST
<p><b>Art. 0801</b> 1 pz = 4  - kg 40,13/ m² 0,257</p> <p><b>Art. 0802</b> 1 pz = 4  - kg 48,28/ m² 0,305</p> <p><b>Art. 0803</b> 1 pz = 4  - kg 55,66/ m² 0,349</p> <p><b>Art. 0805</b> 1 pz = 4  - kg 63,06/ m² 0,367</p> <p><b>Art. 0806</b> 1 pz = 4  - kg 67,11/ m² 0,444</p> <p><b>Art. 0814</b> 1 pz = 4  - kg 48/ m² 0,302</p> <p></p>		<ul style="list-style-type: none"> <li>• EN 1730:2012 - EN 15372:2016 5.1-5.2</li> <li>• EN 1730:2012 - EN 15372:2016 6.3</li> <li>• EN 1730:2012 - EN 15372:2016 6.6</li> <li>• EN 1730:2012 - EN 15372:2016 7.2</li> </ul> <ul style="list-style-type: none"> <li>• EN 1730:2012 - EN 15372:2016 6.2</li> <li>• EN 1730:2012 - EN 15372:2016 6.4.2</li> <li>• EN 1730:2012 - EN 15372:2016 6.9</li> </ul>
<b>FIRE RETARDANT TEST</b>		

Frame Base



V12 matt V39 matt

Top

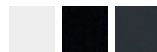

F01 Fenix F02 Fenix F06 Fenix

**Fenix finishes F01, F02: delivery in 4 weeks from the order. Other Fenix colors: delivery in 8 weeks from the order.**



# Nuur Office

Design by Simon Pengelly, 2009



Office table with rectangular top fitted with two openings to be used with cable grommet (Art. 0811) or grommet cover (Art. 0821). Other office accessories complete the layout. It features a laminated Fenix® top and a powder-coated aluminum frame.

Accessories:  
 Modesty Panel Art. 0808  
 Cable Holder Art. 0809  
 Cable Grommet Art. 0811  
 Modesty Panel Art. 0819  
 Grommet cover Art. 0821  
 Drawers chest Art. 0822

	Top		FENIX	
<b>SEK ART. 0815</b>	cm 180x79	<input type="checkbox"/>	25137	
<b>SEK ART. 0817</b>	cm 200x100	<input type="checkbox"/>	28054	
<b>SEK ART. 0818</b>	cm 160x79	<input type="checkbox"/>	22945	

SHIPMENT DETAILS	TECHNICAL SPECIFICATIONS	RESISTANCE TEST
<b>Art. 0815</b> 1 pz = 4  - kg 48/ m² 0,303 <b>Art. 0817</b> 1 pz = 4  - kg 63,06/ m² 0,387 <b>Art. 0818</b> 1 pz = 4  - kg 48,28/ m² 0,305 		
<b>FIRE RETARDANT TEST</b>		

Frame Base



V12 matt V39 matt

Top

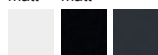

F01 Fenix F02 Fenix F06 Fenix





Fenix finishes F01, F02: delivery in 4 weeks from the order. Other Fenix colors: delivery in 8 weeks from the order.

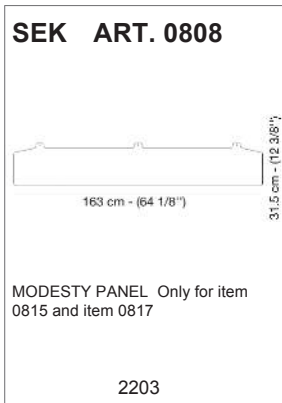
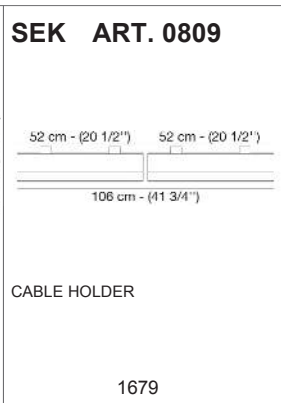
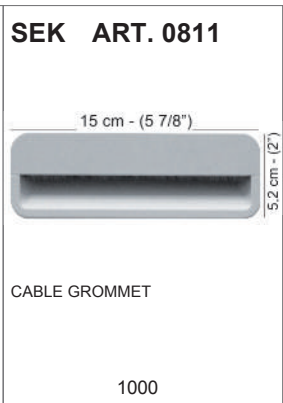
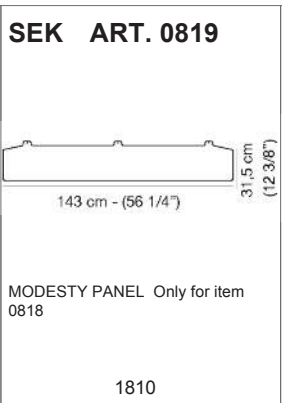
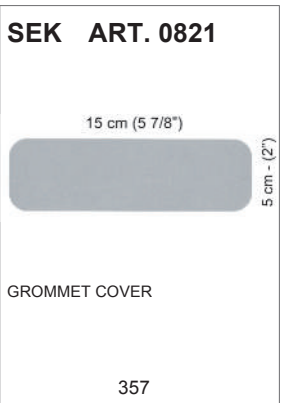
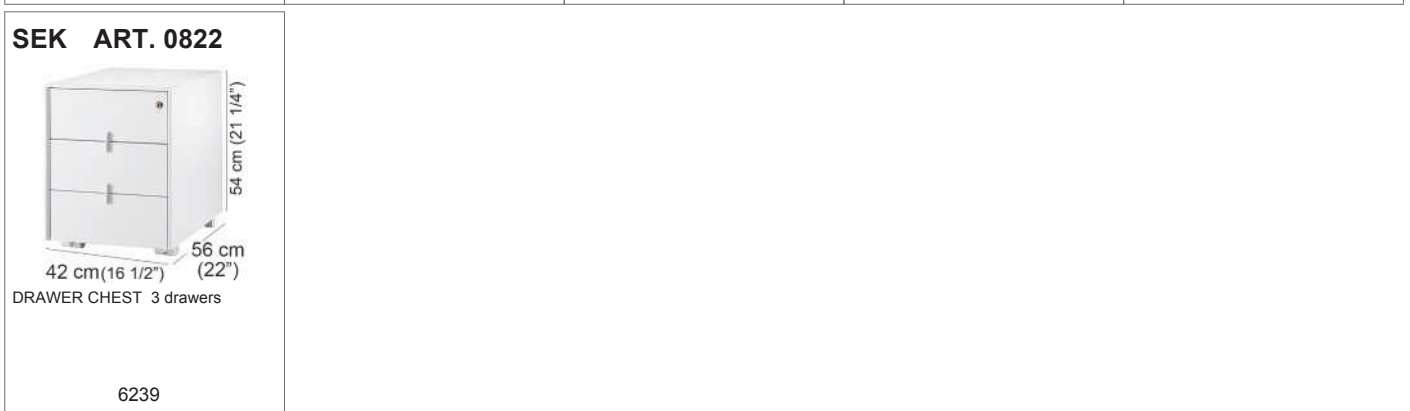

# Accessories

Design by Simon Pengelly, 2009

<p><b>SEK ART. 0808</b></p>  <p>MODESTY PANEL Only for item 0815 and item 0817</p> <p>2203</p>	<p><b>SEK ART. 0809</b></p>  <p>CABLE HOLDER</p> <p>1679</p>	<p><b>SEK ART. 0811</b></p>  <p>CABLE GROMMET</p> <p>1000</p>	<p><b>SEK ART. 0819</b></p>  <p>MODESTY PANEL Only for item 0818</p> <p>1810</p>	<p><b>SEK ART. 0821</b></p>  <p>GROMMET COVER</p> <p>357</p>
<p><b>SEK ART. 0822</b></p>  <p>DRAWER CHEST 3 drawers</p> <p>6239</p>				

SHIPMENT DETAILS		TECHNICAL SPECIFICATIONS	
<b>Art. 0808</b>	1 pz = 1  - kg 13,3/ m³ 0,119	<b>Art. 0809</b>	1 pz = 1  - kg 8,5/ m³ 0,013
<b>Art. 0811</b>	1 pz = 1  - kg 1,2/ m³ 0	<b>Art. 0819</b>	1 pz = 1  - kg 10,4/ m³ 0,017
<b>Art. 0821</b>	1 pz = 1  - kg 1/ m³ 0,006		
<b>FIRE RETARDANT TEST</b>			



# OELL

Design by Jean-Marie Massaud

2022





Collection overview

Type







h 36 cm











h 58 cm

	MDF		Porcelain stoneware	
	h 36 cm	h 58 cm	h 36 cm	h 58 cm
Ø 45 cm		*		*
Ø 60 cm	*		*	

Finishes

- Top:  
 - MDF  
 - Porcelain stoneware

MDF	Base
 M02	 V12
 M20	 V44

Porcelain stoneware	Base			
 C10	 V12	 V44	 V53	 V63
 C11	 V12	 V44	 V53	 V63

# Oell

Design by Jean-Marie Massaud, 2022

Round side table with a central base and asymmetrical column in powdercoated metal. Ø 45 cm top in painted MDF (1.4 cm thick, coordinated with the base finish). Height 58 cm.

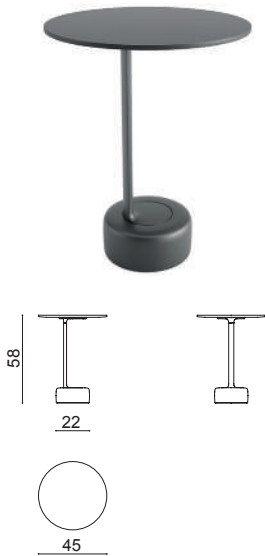

	Top	
<b>SEK ART. 7200</b>	Ø 45 cm h. 58 cm — MDF	6237

SHIPMENT DETAILS	TECHNICAL SPECIFICATIONS	RESISTANCE TEST
<b>Art. 7200</b> 1 pz = 2  - kg 12,42/ m² 0,093 		<ul style="list-style-type: none"> <li>• EN 1730:2012 - EN 15372:2016 6.2</li> <li>• EN 1730:2012 - EN 15372:2016 6.4.2</li> <li>• EN 1730:2012 - EN 15372:2016 6.3</li> <li>• EN 1730:2012 - EN 15372:2016 6.5</li> </ul>
<b>FIRE RETARDANT TEST</b>		

Frame Base



V12 matt V44 matt

Top



M02 M20



# Oell

Design by Jean-Marie Massaud, 2022

Round coffee table with a central base and asymmetrical column in powdercoated metal. Ø 60 cm top in painted MDF (1.4 cm thick, coordinated with the base finish). Height 36 cm.

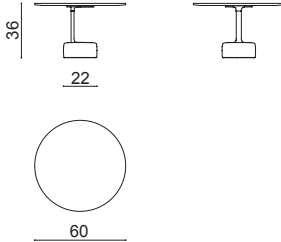

	Top	
<b>SEK ART. 7202</b>	Ø 60 cm h. 36 cm — MDF	6849

SHIPMENT DETAILS	TECHNICAL SPECIFICATIONS	RESISTANCE TEST
<b>Art. 7202</b> 1 pz = 2  - kg 13,1/ m³ 0,113 		
<b>FIRE RETARDANT TEST</b>		

Frame Base



V12 matt V44 matt

Top



M02 M20



# Oell

Design by Jean-Marie Massaud, 2022

Round side table with a central base and asymmetrical column in powdercoated metal. Ø 45 cm top in porcelain stoneware (1 cm thick). Height 58 cm.

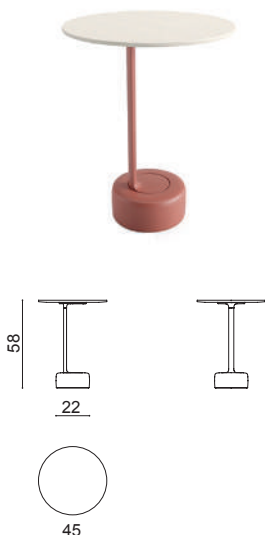

	Top	
<b>SEK ART. 7201</b>	Ø 45 cm h. 58 cm — Ceramic	8970

SHIPMENT DETAILS	TECHNICAL SPECIFICATIONS	RESISTANCE TEST
<b>Art. 7201</b> 1 pz = 2  - kg 14,1/ m³ 0,093 		
<b>FIRE RETARDANT TEST</b>		

Frame Base



V12 matt V44 matt V53 matt V63 matt

Top



C10 C11



# Oell

Design by Jean-Marie Massaud, 2022

Round coffee table with a central base and asymmetrical column in powdercoated metal. Ø 60 cm top in porcelain stoneware (1 cm thick). Height 36 cm.

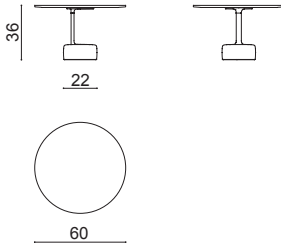

	Top	
<b>SEK ART. 7203</b>	Ø 60 cm h. 36 cm — Ceramic	9639

SHIPMENT DETAILS	TECHNICAL SPECIFICATIONS	RESISTANCE TEST
<b>Art. 7203</b> 1 pz = 2  - kg 16,63/ m² 0,113 		
<b>FIRE RETARDANT TEST</b>		

Frame Base



V12 matt V44 matt V53 matt V63 matt

Top

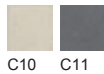

C10 C11



# ONEMM

---

Design by Peter Kunz

2022



## Collection overview

---

### Type



h 74 cm



h 90 cm

---



### Rectangular

	h 74 cm	h 90 cm
160x80 cm	*	*
200x100 cm	*	*
240x100 cm	*	*

---

Top finishes:

— Steel



Through the innovative top construction, the table guarantees stability and flexibility by automatically adapting to any floor.



# One mm

Design by Peter Kunz, 2022



H. 74 cm table with a 4-leg metal base and a rectangular top made of folded and powdercoated sheet steel (4 mm thick), available in three sizes. The base and the top are available in a single-colour combination.

	Top		
<b>SEK ART. 7100</b>	160 x 80 cm 	19191	
<b>SEK ART. 7104</b>	200 x 100 cm 	24494	
<b>SEK ART. 7108</b>	240 x 100 cm 	27846	

SHIPMENT DETAILS	TECHNICAL SPECIFICATIONS	RESISTANCE TEST
<b>Art. 7100</b> 1 pz = 2  - kg 36/ m² 0,136 <b>Art. 7104</b> 1 pz = 2  - kg 47/ m² 0,203 <b>Art. 7108</b> 1 pz = 2  - kg 52/ m² 0,241		<ul style="list-style-type: none"> <li>• EN 1730:2012 - EN 15372:2016 5.1-5.2</li> <li>• EN 1730:2012 - EN 15372:2016 6.3</li> <li>• EN 1730:2012 - EN 15372:2016 6.6</li> <li>• EN 1730:2012 - EN 15372:2016 7.2</li> </ul> <ul style="list-style-type: none"> <li>• EN 1730:2012 - EN 15372:2016 6.2</li> <li>• EN 1730:2012 - EN 15372:2016 6.4.2</li> <li>• EN 1730:2012 - EN 15372:2016 6.9</li> </ul>
<b>FIRE RETARDANT TEST</b>		

Frame Base

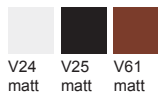

Top

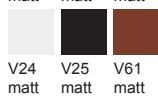



# Onemm

Design by Peter Kunz, 2022



H. 74 cm table with a 4-leg base made of metal with an oak-effect reconstituted wood veneer. Rectangular top made of folded and powdercoated sheet steel (4 mm thick), available in three sizes. The base and top finishes can be freely combined.



	Top		
<b>SEK ART. 7101</b>	160 x 80 cm <input type="checkbox"/>	21984	
<b>SEK ART. 7105</b>	200 x 100 cm <input type="checkbox"/>	27287	
<b>SEK ART. 7109</b>	240 x 100 cm <input type="checkbox"/>	30639	

SHIPMENT DETAILS	TECHNICAL SPECIFICATIONS	RESISTANCE TEST
<b>Art. 7101</b> 1 pz = 2  - kg 37/ m² 0,136 <b>Art. 7105</b> 1 pz = 2  - kg 48/ m² 0,203 <b>Art. 7109</b> 1 pz = 2  - kg 53/ m² 0,241		
<b>FIRE RETARDANT TEST</b>		

Frame Base

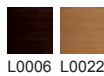

L0006 L0022

Top

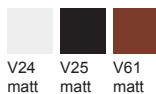

V24 matt V25 matt V61 matt



# Onemm

Design by Peter Kunz, 2022



H. 90 cm table with a 4-leg metal base and rectangular top made of folded and powdercoated sheet steel (4 mm thick), available in three sizes. The base and the top are available in a single-colour combination.



	Top		
<b>SEK ART. 7102</b>	160 x 80 cm <input type="checkbox"/>	19367	
<b>SEK ART. 7106</b>	200 x 100 cm <input type="checkbox"/>	24670	
<b>SEK ART. 7110</b>	240 x 100 cm <input type="checkbox"/>	28022	

SHIPMENT DETAILS	TECHNICAL SPECIFICATIONS	RESISTANCE TEST
<b>Art. 7102</b> 1 pz = 2  - kg 37,4/ m³ 0,136 <b>Art. 7106</b> 1 pz = 2  - kg 48,4/ m³ 0,203 <b>Art. 7110</b> 1 pz = 2  - kg 53,4/ m³ 0,241		
<b>FIRE RETARDANT TEST</b>		

Frame Base



Top



# OneMM

Design by Peter Kunz, 2022



H. 90 cm table with a 4-leg base made of metal with an oak-effect reconstituted wood veneer. Rectangular top made of folded and powdercoated sheet steel (4 mm thick), available in three sizes. The base and top finishes can be freely combined.



	Top		
<b>SEK ART. 7103</b>	160 x 80 cm <input type="checkbox"/>	22905	
<b>SEK ART. 7107</b>	200 x 100 cm <input type="checkbox"/>	28208	
<b>SEK ART. 7111</b>	240 x 100 cm <input type="checkbox"/>	31560	

SHIPMENT DETAILS	TECHNICAL SPECIFICATIONS	RESISTANCE TEST
<b>Art. 7103</b> 1 pz = 2  - kg 38,5/ m³ 0,136 <b>Art. 7107</b> 1 pz = 2  - kg 49,5/ m³ 0,203 <b>Art. 7111</b> 1 pz = 2  - kg 54,5/ m³ 0,241		
<b>FIRE RETARDANT TEST</b>		

Frame Base



L0006 L0022

Top

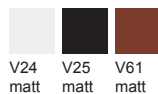

V24 matt V25 matt V61 matt



# PIX TABLE

Design by Ichiro Iwasaki

2014



# Pix Table

Design by Ichiro Iwasaki, 2014

Table with round powdercoated metal base and MDF round top (Thick 1,2 cm) fitted with gas-lift mechanism for height adjustment. Base and top are available in 2 different colors.

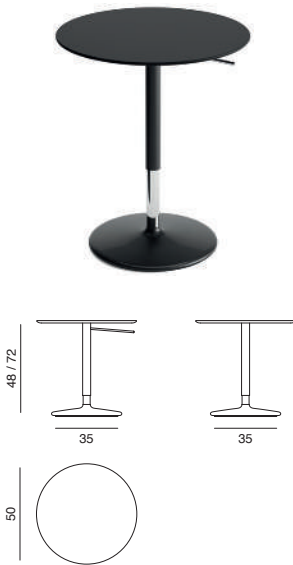

<b>SEK ART. 3050</b>	Top	POWDERCOATED	
		8716	

SHIPMENT DETAILS	TECHNICAL SPECIFICATIONS	RESISTANCE TEST
<b>Art. 3050</b> 1 pz = 1  - kg 21,5/ m³ 0,173		
<b>FIRE RETARDANT TEST</b>		

Frame Base



V12 V39  
matt matt

Top



M02 M04



# PLY TABLE

Design by  
Lievore Altherr Molina  
2013





# Ply

Design by Lievore Altherr Molina, 2013

Low table with oak veneer three-leg base, available in natural oak and black finishes. It is provided with glides with felt insert for wood floors. Height 44 cm.

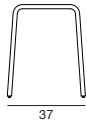
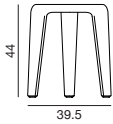

<b>SEK ART. 3800</b>	Top	-	
		4727	

SHIPMENT DETAILS	TECHNICAL SPECIFICATIONS	RESISTANCE TEST
<b>Art. 3800</b> 1 pz = 1  - kg 3/ m² 0,072		
<b>FIRE RETARDANT TEST</b>		

Frame Base

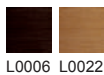

L0006 L0022





# Ply Table

Design by Lievore Altherr Molina, 2013

Oak veneer low table with large-sized top (99 cm x 93 cm) and three-leg base. It is available in natural oak and black finishes. It's also provided with felt glides for wood floors. Height 36 cm.

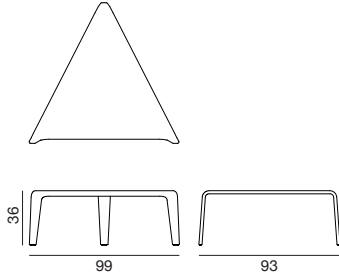

<b>SEK ART. 3850</b>	Top	-	
		13241	

SHIPMENT DETAILS	TECHNICAL SPECIFICATIONS	RESISTANCE TEST
<b>Art. 3850</b> 1 pz = 1  - kg 12,32/ m² 0,357		
<b>FIRE RETARDANT TEST</b>		

Frame Base

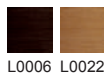

# Ply Table

Design by Lievore Altherr Molina, 2013

Oak veneer low table with right-hand medium-sized top (53 cm x 93 cm) and three-leg base. It is available in natural oak and black finishes. It's also provided with felt glides for wood floors. Height 36 cm.

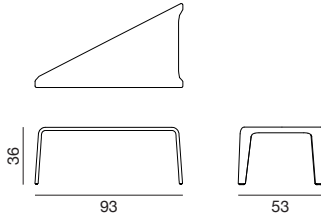

<b>SEK ART. 3851</b>	Top	-	
		7811	

SHIPMENT DETAILS	TECHNICAL SPECIFICATIONS	RESISTANCE TEST
<b>Art. 3851</b> 1 pz = 1  - kg 8,02/ m³ 0,189		
<b>FIRE RETARDANT TEST</b>		

Frame Base

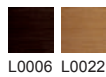

# Ply Table

Design by Lievore Altherr Molina, 2013

Oak veneer low table with left-hand medium-sized top (53 cm x 93 cm) and three-leg base. It is available in natural oak and black finishes and provided with felt glides insert for wood floors. Height 36 cm.

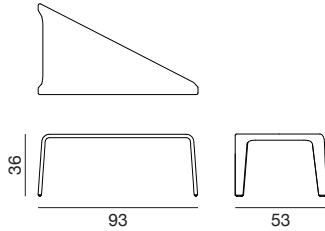

<b>SEK ART. 3852</b>	Top	-	
		7811	

SHIPMENT DETAILS	TECHNICAL SPECIFICATIONS	RESISTANCE TEST
<b>Art. 3852</b> 1 pz = 1  - kg 8,02/ m <sup>2</sup> 0,189		
<b>FIRE RETARDANT TEST</b>		

Frame Base

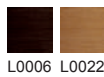

# Ply Table

Design by Lievore Altherr Molina, 2013

Oak veneer low table with small-sized top (55 cm x 54 cm) and three-leg base. It is available in natural oak and black finishes and provided with felt glides insert for wood floors. Height 36 cm.

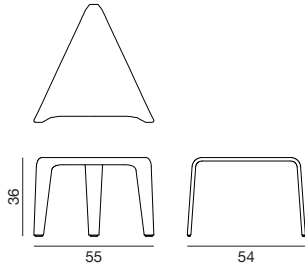

<b>SEK ART. 3853</b>	Top	-	
		6358	

SHIPMENT DETAILS	TECHNICAL SPECIFICATIONS	RESISTANCE TEST
<b>Art. 3853</b> 1 pz = 1  - kg 5,08/ m³ 0,169		
<b>FIRE RETARDANT TEST</b>		

Frame Base

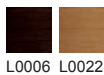



# RALIK TABLE

Design by Ichiro Iwasaki

2023



# Ralik

Design by Ichiro Iwasaki, 2023

Side table with central base and column in powder-coated metal, equipped with gas mechanism for height adjustment. Rectangular top in plywood and finish in reconstituted oak (1,2 cm thick). The base and top finishes can be freely combined.

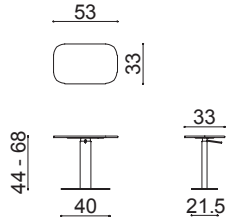

	Top	
<b>SEK ART. 7417</b>	H. adj. freestanding table	8845

SHIPMENT DETAILS	TECHNICAL SPECIFICATIONS	RESISTANCE TEST
<b>Art. 7417</b> 1 pz = 1  - kg 10/ m³ 0,12 		
<b>FIRE RETARDANT TEST</b>		

Frame Base



Top

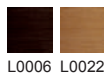

# SAUL

Design by Jean-Marie Massaud

2019





# Saul

## Collection overview

### Type



h 28,5 cm

h 36,5 cm

h 42,5 cm

		Glass			Marble		
		h 28,5 cm	h 36,5 cm	h 42,5 cm	h 28,5 cm	h 36,5 cm	h 42,5 cm
<b>Round top</b>	Ø 84 cm	*	*	*	*	*	*
<b>Square top</b>	60x60 cm	*	*	*	*	*	*
	77x77 cm	*	*	*			
<b>Rectangular top</b>	120x60 cm	*	*	*			

### Top finishes

- Glass
- Marble

# Saul

Design by Jean-Marie Massaud, 2019



Low table with 4-leg base in powder-coated aluminium in three height options: 28,5; 36,5 or 42,5 cm. Top in black painted smoked glass available in round, rectangular and square (2 sizes) shape.

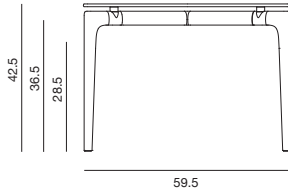

	Top		POWDERCOATED
<b>SEK ART. 6700</b>	V02 cm 60x60 — h cm 42,5	<input type="checkbox"/>	11895
<b>SEK ART. 6701</b>	V02 Ø cm 84 — h cm 42,5	<input type="radio"/>	13098
<b>SEK ART. 6702</b>	V02 cm 120x60 — h cm 42,5	<input type="checkbox"/>	14348
<b>SEK ART. 6703</b>	V02 cm 77x77 — h cm 42,5	<input type="checkbox"/>	12683
<b>SEK ART. 6706</b>	V02 cm 60x60 — h cm 36,5	<input type="checkbox"/>	11895
<b>SEK ART. 6707</b>	V02 Ø cm 84 — h cm 36,5	<input type="radio"/>	13098
<b>SEK ART. 6708</b>	V02 cm 120x60 — h cm 36,5	<input type="checkbox"/>	14348
<b>SEK ART. 6709</b>	V02 cm 77x77 — h cm 36,5	<input type="checkbox"/>	12683
<b>SEK ART. 6712</b>	V02 cm 60x60 — h cm 28,5	<input type="checkbox"/>	11895
<b>SEK ART. 6713</b>	V02 Ø cm 84 — h cm 28,5	<input type="radio"/>	13098
<b>SEK ART. 6714</b>	V02 cm 120x60 — h cm 28,5	<input type="checkbox"/>	14348
<b>SEK ART. 6715</b>	V02 cm 77x77 — h cm 28,5	<input type="checkbox"/>	12683

SHIPMENT DETAILS		RESISTANCE TEST	
<b>Art. 6700</b> 1 pz = 3  - kg 13,9/ m³ 0,1	<b>Art. 6701</b> 1 pz = 3  - kg 18,9/ m³ 0,12	• EN 1730:2012 - EN 15372:2016 6.2	• EN 1730:2012 - EN 15372:2016 6.3
<b>Art. 6702</b> 1 pz = 3  - kg 22,9/ m³ 0,12	<b>Art. 6703</b> 1 pz = 3  - kg 19,7/ m³ 0,11	• EN 1730:2012 - EN 15372:2016 6.4.2	
<b>Art. 6706</b> 1 pz = 3  - kg 13,7/ m³ 0,1	<b>Art. 6707</b> 1 pz = 3  - kg 18,7/ m³ 0,12	TECHNICAL SPECIFICATIONS	
<b>Art. 6708</b> 1 pz = 3  - kg 22,7/ m³ 0,12	<b>Art. 6709</b> 1 pz = 3  - kg 19,5/ m³ 0,11		
<b>Art. 6712</b> 1 pz = 3  - kg 13,4/ m³ 0,1	<b>Art. 6713</b> 1 pz = 3  - kg 18,7/ m³ 0,12		
<b>Art. 6714</b> 1 pz = 3  - kg 22,4/ m³ 0,12	<b>Art. 6715</b> 1 pz = 3  - kg 19,2/ m³ 0,11		
FIRE RETARDANT TEST			

Frame Base



V44  
matt

Top



V02



# Saul

Design by Jean-Marie Massaud, 2019



Low table with 4-leg base in powder-coated aluminium in three height options: 28,5; 36,5 or 42,5 cm. Top in white marble available in round and square shape.

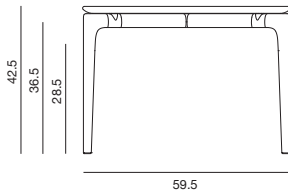

	Top		POWDERCOATED
<b>SEK ART. 6704</b>	B01 cm 60x60 — h cm 42,5	<input type="checkbox"/>	23660
<b>SEK ART. 6705</b>	B01 Ø cm 84 — h cm 42,5	<input type="radio"/>	29934
<b>SEK ART. 6710</b>	B01 cm 60x60 — h cm 36,5	<input type="checkbox"/>	23660
<b>SEK ART. 6711</b>	B01 Ø cm 84 — h cm 36,5	<input type="radio"/>	29934
<b>SEK ART. 6716</b>	B01 cm 60x60 — h cm 28,5	<input type="checkbox"/>	23660
<b>SEK ART. 6717</b>	B01 Ø cm 84 — h cm 28,5	<input type="radio"/>	29934

SHIPMENT DETAILS		RESISTANCE TEST
<b>Art. 6704</b> 1 pz = 3  - kg 46,9/ m³ 0,67	<b>Art. 6705</b> 1 pz = 3  - kg 73,9/ m³ 1,32	
<b>Art. 6710</b> 1 pz = 3  - kg 46,7/ m³ 0,67	<b>Art. 6711</b> 1 pz = 3  - kg 73,7/ m³ 1,32	
<b>Art. 6716</b> 1 pz = 3  - kg 46,4/ m³ 0,67	<b>Art. 6717</b> 1 pz = 3  - kg 73,4/ m³ 1,32	
		<b>TECHNICAL SPECIFICATIONS</b>

## FIRE RETARDANT TEST

Frame Base



V44  
matt

Top



B01



WIM

---

Design by  
Lievore Altherr Molina  
2016



# Wim

## Collection overview



### Type





h 74 cm

h 105 cm

#### h 74 cm

		
	Ø 59 cm	60x60 cm
	Ø 69 cm	70x70 cm
	Ø 79 cm	80x80 cm
	Ø 89 cm	90x90 cm

#### h 105 cm

		
	Ø 59 cm	60x60 cm
	Ø 69 cm	70x70 cm
	Ø 79 cm	80x80 cm

Actual top/finish dimensions are available in the price list.

#### Top finishes

- Melamine
- Fenix®
- HPL (Outdoor)

# Wim

Design by Lievore Altherr Molina, 2016

Table with top of chipboard panel with melamine finish in white or black, 2,5 cm thick. Powdercoated aluminum structure fitted with adjustable glides. Available in different shapes: round and square. Height 74 cm.

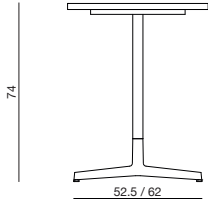

		Top	POWDERCOATED
	<b>SEK ART. 5500</b>	STRUCTURE ONLY - L cm 52.5	3381
	<b>SEK ART. 5502</b>	STRUCTURE ONLY - L cm 62	3536
	<b>SEK ART. 5571</b>	STRUCTURE ONLY - L cm 62 - "Reinforced"	3882
⊗	<b>SEK ART. 5512</b>	STRUCTURE L cm 52.5 - Top ø cm 59	5393
	<b>SEK ART. 5513</b>	STRUCTURE L cm 52.5 - Top ø cm 69	5429
	<b>SEK ART. 5514</b>	STRUCTURE L cm 62 - Top ø cm 79	5917
	<b>SEK ART. 5515</b>	STRUCTURE L cm 62 "R" - Top ø cm 89	6633
⊗	<b>SEK ART. 5508</b>	STRUCTURE L cm 52.5 - Top cm 59 x 59	4810
	<b>SEK ART. 5509</b>	STRUCTURE L cm 52.5 - Top cm 69 x 69	5084
	<b>SEK ART. 5510</b>	STRUCTURE L cm 62 - Top cm 79 x 79	5441
	<b>SEK ART. 5511</b>	STRUCTURE L cm 62 "R" - Top cm 89 x 89	6097

SHIPMENT DETAILS	RESISTANCE TEST
<b>Art. 5500</b> 1 pz = 1  - kg 5,95/ m³ 0,083 <b>Art. 5508</b> 1 pz = 2  - kg 13,57/ m³ 0,113 <b>Art. 5510</b> 1 pz = 2  - kg 20,83/ m³ 0,172 <b>Art. 5512</b> 1 pz = 2  - kg 12,45/ m³ 0,113 <b>Art. 5514</b> 1 pz = 2  - kg 18,81/ m³ 0,172 <b>Art. 5571</b> 1 pz = 1  - kg 17,95/ m³ 0,414 <b>Art. 5502</b> 1 pz = 1  - kg 7,2/ m³ 0,121 <b>Art. 5509</b> 1 pz = 2  - kg 16,36/ m³ 0,123 <b>Art. 5511</b> 1 pz = 2  - kg 35,23/ m³ 0,479 <b>Art. 5513</b> 1 pz = 2  - kg 14,82/ m³ 0,123 <b>Art. 5515</b> 1 pz = 2  - kg 32,68/ m³ 0,479	
	<b>TECHNICAL SPECIFICATIONS</b>

FIRE RETARDANT TEST

Frame Base



Top

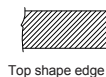

# Wim

Design by Lievore Altherr Molina, 2016

Table with white or black top in Fenix® laminate finish, 2,4 cm thick. Powdercoated aluminum structure fitted with adjustable glides. Available in different shapes: round and square. Height 74 cm.

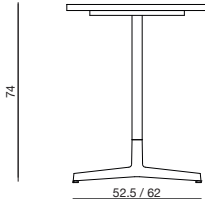

		Top	POWDERCOATED
	<b>SEK ART. 5500</b>	STRUCTURE ONLY - L cm 52.5	3381
	<b>SEK ART. 5502</b>	STRUCTURE ONLY - L cm 62	3536
	<b>SEK ART. 5571</b>	STRUCTURE ONLY - L cm 62 - "Reinforced"	3882
⊗	<b>SEK ART. 5532</b>	STRUCTURE L cm 52.5 - Top ø cm 59	6037
	<b>SEK ART. 5533</b>	STRUCTURE L cm 52.5 - Top ø cm 69	6179
	<b>SEK ART. 5534</b>	STRUCTURE L cm 62 - Top ø cm 79	6596
	<b>SEK ART. 5535</b>	STRUCTURE L cm 62 "R" - Top ø cm 89	7645
⊗	<b>SEK ART. 5528</b>	STRUCTURE L cm 52.5 - Top cm 59 x 59	5132
	<b>SEK ART. 5529</b>	STRUCTURE L cm 52.5 - Top cm 69 x 69	5500
	<b>SEK ART. 5530</b>	STRUCTURE L cm 62 - Top cm 79 x 79	5989
	<b>SEK ART. 5531</b>	STRUCTURE L cm 62 "R" - Top cm 89 x 89	7026

SHIPMENT DETAILS	RESISTANCE TEST
<b>Art. 5500</b> 1 pz = 1  - kg 5,95/ m³ 0,083 <b>Art. 5528</b> 1 pz = 2  - kg 14,7/ m³ 0,113 <b>Art. 5530</b> 1 pz = 2  - kg 22,86/ m³ 0,172 <b>Art. 5532</b> 1 pz = 2  - kg 13,34/ m³ 0,113 <b>Art. 5534</b> 1 pz = 2  - kg 20,41/ m³ 0,172 <b>Art. 5571</b> 1 pz = 1  - kg 17,95/ m³ 0,414 <b>Art. 5502</b> 1 pz = 1  - kg 7,2/ m³ 0,121 <b>Art. 5529</b> 1 pz = 2  - kg 17,91/ m³ 0,123 <b>Art. 5531</b> 1 pz = 2  - kg 37,81/ m³ 0,479 <b>Art. 5533</b> 1 pz = 2  - kg 16,04/ m³ 0,123 <b>Art. 5535</b> 1 pz = 2  - kg 34,7/ m³ 0,479	TECHNICAL SPECIFICATIONS

FIRE RETARDANT TEST

Frame Base Top

V12 V39 F01 F02  
matt matt Fenix Fenix

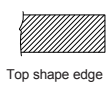

# Wim

Design by Lievore Altherr Molina, 2016

Table with white or black top in Compact HPL, 1 cm thick.  
Powdercoated aluminum structure fitted with adjustable glides.  
Available in different shapes: round and square. Height 72.5 cm.

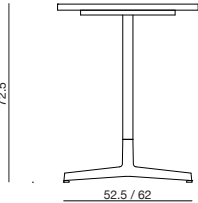

	Top	POWDERCOATED
<b>SEK ART. 5500</b>	STRUCTURE ONLY - L cm 52.5	3381
<b>SEK ART. 5502</b>	STRUCTURE ONLY - L cm 62	3536
<b>SEK ART. 5571</b>	STRUCTURE ONLY - L cm 62 - "Reinforced"	3882
	<b>SEK ART. 5552</b> STRUCTURE L cm 52.5 - Top ø cm 59	5381
	<b>SEK ART. 5553</b> STRUCTURE L cm 52.5 - Top ø cm 69	6334
	<b>SEK ART. 5554</b> STRUCTURE L cm 62 - Top ø cm 79	6858
	<b>SEK ART. 5555</b> STRUCTURE L cm 62 "R" - Top ø cm 89	7787
	<b>SEK ART. 5548</b> STRUCTURE L cm 52.5 - Top cm 59 x 59	5381
	<b>SEK ART. 5549</b> STRUCTURE L cm 52.5 - Top cm 69 x 69	6334
	<b>SEK ART. 5550</b> STRUCTURE L cm 62 - Top cm 79 x 79	6858
	<b>SEK ART. 5551</b> STRUCTURE L cm 62 "R" - Top cm 89 x 89	7787
Outdoor powdercoated		+ 95

SHIPMENT DETAILS		RESISTANCE TEST
<b>Art. 5500</b> 1 pz = 1  - kg 5,95/ m³ 0,083 <b>Art. 5548</b> 1 pz = 2  - kg 13,36/ m³ 0,113 <b>Art. 5550</b> 1 pz = 2  - kg 20,45/ m³ 0,172 <b>Art. 5552</b> 1 pz = 2  - kg 12,28/ m³ 0,113 <b>Art. 5554</b> 1 pz = 2  - kg 18,52/ m³ 0,172 <b>Art. 5571</b> 1 pz = 1  - kg 17,95/ m³ 0,414	<b>Art. 5502</b> 1 pz = 1  - kg 7,2/ m³ 0,121 <b>Art. 5549</b> 1 pz = 2  - kg 16,07/ m³ 0,123 <b>Art. 5551</b> 1 pz = 2  - kg 34,76/ m³ 0,479 <b>Art. 5553</b> 1 pz = 2  - kg 14,6/ m³ 0,123 <b>Art. 5555</b> 1 pz = 2  - kg 32,31/ m³ 0,479	<b>TECHNICAL SPECIFICATIONS</b>
<b>FIRE RETARDANT TEST</b>		

Frame Base Top

V12 matt V39 matt H02 H03

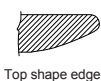



# Wim

Design by Lievore Altherr Molina, 2016

Table with top of chipboard panel with melamine finish in white or black , 2,5 cm thick. Powdercoated aluminum structure fitted with adjustable glides. Available in different shapes: round and square. Height 105 cm.



		Top	POWDERCOATED
	<b>SEK ART. 5501</b>	STRUCTURE ONLY - L cm 52.5	3751
	<b>SEK ART. 5503</b>	STRUCTURE ONLY - L cm 62	3893
	<b>SEK ART. 5521</b>	STRUCTURE L cm 52.5 - Top ø cm 59	5763
	<b>SEK ART. 5522</b>	STRUCTURE L cm 52.5 - Top ø cm 69	5799
	<b>SEK ART. 5523</b>	STRUCTURE L cm 62 - Top ø cm 79	6274
	<b>SEK ART. 5518</b>	STRUCTURE L cm 52.5 - Top cm 59 x 59	5180
	<b>SEK ART. 5519</b>	STRUCTURE L cm 52.5 - Top cm 69 x 69	5454
	<b>SEK ART. 5520</b>	STRUCTURE L cm 62 - Top cm 79 x 79	5798

SHIPMENT DETAILS		RESISTANCE TEST	
<b>Art. 5501</b> 1 pz = 1  - kg 6,85/ m³ 0,121	<b>Art. 5503</b> 1 pz = 1  - kg 7,55/ m³ 0,121	• EN 1730:2012 - EN 15372:2016 5.1-5.2	• EN 1730:2012 - EN 15372:2016 6.2
<b>Art. 5518</b> 1 pz = 2  - kg 14,47/ m³ 0,151	<b>Art. 5519</b> 1 pz = 2  - kg 17,26/ m³ 0,161	• EN 1730:2012 - EN 15372:2016 6.3	• EN 1730:2012 - EN 15372:2016 6.4.2
<b>Art. 5520</b> 1 pz = 2  - kg 21,18/ m³ 0,172	<b>Art. 5521</b> 1 pz = 2  - kg 13,35/ m³ 0,151	• EN 1730:2012 - EN 15372:2016 6.5	• EN 1730:2012 - EN 15372:2016 6.6
<b>Art. 5522</b> 1 pz = 2  - kg 15,72/ m³ 0,161	<b>Art. 5523</b> 1 pz = 2  - kg 19,16/ m³ 0,172	• EN 1730:2012 - EN 15372:2016 7.2	
<b>FIRE RETARDANT TEST</b>		<b>TECHNICAL SPECIFICATIONS</b>	

Frame Base



Top

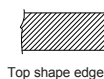

# Wim

Design by Lievore Altherr Molina, 2016

Table with white or black top in Fenix® laminate finish, 2,4 cm thick. Powdercoated aluminum structure fitted with adjustable glides. Available in different shapes: round and square. Height 105 cm.

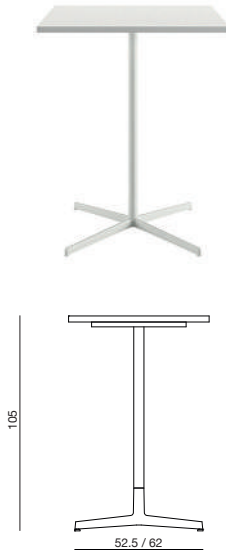

		Top	POWDERCOATED
	<b>SEK ART. 5501</b>	STRUCTURE ONLY - L cm 52.5	3751
	<b>SEK ART. 5503</b>	STRUCTURE ONLY - L cm 62	3893
	<b>SEK ART. 5541</b>	STRUCTURE L cm 52.5 - Top ø cm 59	6407
	<b>SEK ART. 5542</b>	STRUCTURE L cm 52.5 - Top ø cm 69	6549
	<b>SEK ART. 5543</b>	STRUCTURE L cm 62 - Top ø cm 79	6953
	<b>SEK ART. 5538</b>	STRUCTURE L cm 52.5 - Top cm 59x59	5502
	<b>SEK ART. 5539</b>	STRUCTURE L cm 52.5 - Top cm 69 x 69	5870
	<b>SEK ART. 5540</b>	STRUCTURE L cm 62 - Top cm 79 x 79	6346

SHIPMENT DETAILS		RESISTANCE TEST
<b>Art. 5501</b> 1 pz = 1  - kg 6,85/ m³ 0,121	<b>Art. 5503</b> 1 pz = 1  - kg 7,55/ m³ 0,121	<b>TECHNICAL SPECIFICATIONS</b>
<b>Art. 5538</b> 1 pz = 2  - kg 15,6/ m³ 0,151	<b>Art. 5539</b> 1 pz = 2  - kg 18,81/ m³ 0,161	
<b>Art. 5540</b> 1 pz = 2  - kg 23,21/ m³ 0,172	<b>Art. 5541</b> 1 pz = 2  - kg 14,24/ m³ 0,151	
<b>Art. 5542</b> 1 pz = 2  - kg 16,94/ m³ 0,161	<b>Art. 5543</b> 1 pz = 2  - kg 20,76/ m³ 0,172	
<b>FIRE RETARDANT TEST</b>		

Frame Base



Top

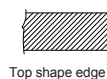
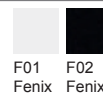

# Wim

Design by Lievore Altherr Molina, 2016

Table with white or black top in Compact HPL, 1 cm thick.  
Powdercoated aluminum structure fitted with adjustable glides.  
Available in different shapes: round and square. Height 103.5 cm.



		Top	POWDERCOATED
	<b>SEK ART. 5501</b>	STRUCTURE ONLY - L cm 52.5	3751
	<b>SEK ART. 5503</b>	STRUCTURE ONLY - L cm 62	3893
	<b>SEK ART. 5561</b>	STRUCTURE L cm 52.5 - Top ø cm 59	5751
	<b>SEK ART. 5562</b>	STRUCTURE L cm 52.5 - Top ø cm 69	6704
	<b>SEK ART. 5563</b>	STRUCTURE L cm 62 - Top ø cm 79	7215
	<b>SEK ART. 5558</b>	STRUCTURE L cm 52.5 - Top cm 59 x 59	5751
	<b>SEK ART. 5559</b>	STRUCTURE L cm 52.5 - Top cm 69 x 69	6704
	<b>SEK ART. 5560</b>	STRUCTURE L cm 62 - Top cm 79 x 79	7215
Outdoor powdercoated			+ 95

SHIPMENT DETAILS		RESISTANCE TEST
<b>Art. 5501</b> 1 pz = 1  - kg 6,85/ m³ 0,121	<b>Art. 5503</b> 1 pz = 1  - kg 7,55/ m³ 0,121	
<b>Art. 5558</b> 1 pz = 2  - kg 14,26/ m³ 0,151	<b>Art. 5559</b> 1 pz = 2  - kg 16,97/ m³ 0,161	
<b>Art. 5560</b> 1 pz = 2  - kg 20,8/ m³ 0,172	<b>Art. 5561</b> 1 pz = 2  - kg 13,18/ m³ 0,151	
<b>Art. 5562</b> 1 pz = 2  - kg 15,5/ m³ 0,161	<b>Art. 5563</b> 1 pz = 2  - kg 18,87/ m³ 0,172	
<b>FIRE RETARDANT TEST</b>		<b>TECHNICAL SPECIFICATIONS</b>

Frame Base



Top

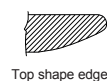

# YOP

Design by  
Lievore Altherr Molina  
2016



Collection overview

Type





h 74 cm





h 105 cm

h 74 cm

		
	Ø 59 cm*	60x60 cm*
	Ø 69 cm*	70x70 cm*
	Ø 79 cm*	80x80 cm*

h 105 cm

		
	Ø 59 cm*	59x59 cm*
	Ø 69 cm*	69x69 cm*
	Ø 79 cm*	79x79 cm*

Actual top/finish dimensions are available in the price list.

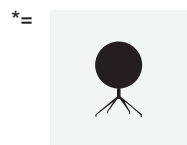

Flipping mechanism

Top finishes

- Melamine
- Laminate Fenix®
- HPL (Outdoor)

# Yop

Design by Lievore Altherr Molina, 2016

Table with top of chipboard panel with melamine finish in white or black , 2,5 cm thick. Powdercoated aluminum structure fitted with adjustable glides. Available in different shapes: round and square (fixed version or with flipping mechanism). Height 74 cm.

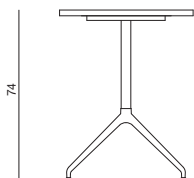

		Top	POWDERCOATED
	<b>SEK ART. 5700</b>	STRUCTURE ONLY	3108
⊗	<b>SEK ART. 5709</b>	∅ cm 59 ( * )	5120
	<b>SEK ART. 5710</b>	∅ cm 69 ( * )	5156
	<b>SEK ART. 5711</b>	∅ cm 79 ( * )	5489
⊗	<b>SEK ART. 5706</b>	cm 59 x 59 ( * )	4537
	<b>SEK ART. 5707</b>	cm 69 x 69 ( * )	4811
	<b>SEK ART. 5708</b>	cm 79 x 79 ( * )	5013
* Flipping mechanism			✚ 488

SHIPMENT DETAILS		RESISTANCE TEST	
<b>Art. 5700</b> 1 pz = 1  - kg 6,15/ m³ 0,126	<b>Art. 5706</b> 1 pz = 2  - kg 13,77/ m³ 0,156	• EN 1730:2012 - EN 15372:2016 6.2	• EN 1730:2012 - EN 15372:2016 6.3
<b>Art. 5707</b> 1 pz = 2  - kg 16,6/ m³ 0,166	<b>Art. 5708</b> 1 pz = 2  - kg 19,78/ m³ 0,177	• EN 1730:2012 - EN 15372:2016 6.4.2	• EN 1730:2012 - EN 15372:2016 6.5
<b>Art. 5709</b> 1 pz = 2  - kg 12,65/ m³ 0,156	<b>Art. 5710</b> 1 pz = 2  - kg 15,02/ m³ 0,166	<b>TECHNICAL SPECIFICATIONS</b>	
<b>Art. 5711</b> 1 pz = 2  - kg 17,76/ m³ 0,177		<b>FIRE RETARDANT TEST</b>	

Frame Base



Top

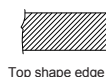

# Yop

Design by Lievore Altherr Molina, 2016

Table with white or black top in Fenix® laminate finish, 2,4 cm thick. Powdercoated aluminum structure fitted with adjustable glides. Available in different shapes: round and square (fixed version or with flipping mechanism). Height 74 cm.

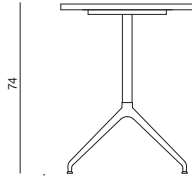

		Top	POWDERCOATED
	<b>SEK ART. 5700</b>	STRUCTURE ONLY	3108
	<b>SEK ART. 5726</b>	ø cm 59 ( * )	5764
	<b>SEK ART. 5727</b>	ø cm 69 ( * )	5906
	<b>SEK ART. 5728</b>	ø cm 79 ( * )	6168
	<b>SEK ART. 5723</b>	cm 59 x 59 ( * )	4859
	<b>SEK ART. 5724</b>	cm 69 x 69 ( * )	5227
	<b>SEK ART. 5725</b>	cm 79 x 79 ( * )	5561
* Flipping mechanism			✚ 488

SHIPMENT DETAILS	RESISTANCE TEST
<b>Art. 5700</b> 1 pz = 1  - kg 6,15/ m³ 0,126 <b>Art. 5723</b> 1 pz = 2  - kg 14,9/ m³ 0,156 <b>Art. 5724</b> 1 pz = 2  - kg 18,11/ m³ 0,166 <b>Art. 5725</b> 1 pz = 2  - kg 21,81/ m³ 0,177 <b>Art. 5726</b> 1 pz = 2  - kg 13,54/ m³ 0,156 <b>Art. 5727</b> 1 pz = 2  - kg 16,24/ m³ 0,166 <b>Art. 5728</b> 1 pz = 2  - kg 19,36/ m³ 0,177	
<b>FIRE RETARDANT TEST</b>	<b>TECHNICAL SPECIFICATIONS</b>

Frame Base



Top

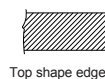
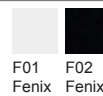

# Yop

Design by Lievore Altherr Molina, 2016

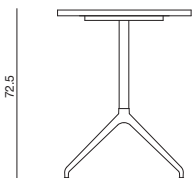

Table with white or black top in Compact HPL, 1 cm thick.  
Powdercoated aluminum structure fitted with adjustable glides.  
Available in different shapes: round and square (fixed version or with flipping mechanism). Height 72.5 cm.

		Top	POWDERCOATED
	<b>SEK ART. 5700</b>	STRUCTURE ONLY	3108
	<b>SEK ART. 5743</b>	∅ cm 59 ( * )	5108
	<b>SEK ART. 5744</b>	∅ cm 69 ( * )	6061
	<b>SEK ART. 5745</b>	∅ cm 79 ( * )	6430
	<b>SEK ART. 5740</b>	cm 59 x 59 ( * )	5108
	<b>SEK ART. 5741</b>	cm 69 x 69 ( * )	6061
	<b>SEK ART. 5742</b>	cm 79 x 79 ( * )	6430
		* Flipping mechanism	+ 488
		Outdoor powdercoated	+ 95

SHIPMENT DETAILS	RESISTANCE TEST
<b>Art. 5700</b> 1 pz = 1  - kg 6,15/ m³ 0,126 <b>Art. 5740</b> 1 pz = 2  - kg 13,56/ m³ 0,156 <b>Art. 5741</b> 1 pz = 2  - kg 16,27/ m³ 0,166 <b>Art. 5742</b> 1 pz = 2  - kg 19,4/ m³ 0,177 <b>Art. 5743</b> 1 pz = 2  - kg 12,48/ m³ 0,156 <b>Art. 5744</b> 1 pz = 2  - kg 14,8/ m³ 0,166 <b>Art. 5745</b> 1 pz = 2  - kg 17,47/ m³ 0,177	
<b>FIRE RETARDANT TEST</b>	<b>TECHNICAL SPECIFICATIONS</b>

Frame Base



Top

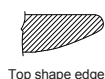
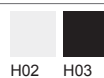

Top shape edge



Outdoor use



# Yop

Design by Lievore Altherr Molina, 2016

Table with top of chipboard panel with melamine finish in white or black , 2,5 cm thick. Powdercoated aluminum structure fitted with adjustable glides. Available in different shapes: round and square (fixed version or with flipping mechanism). Height 105 cm.

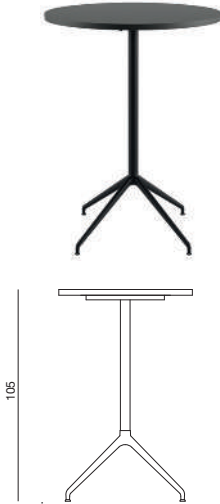

		Top	POWDERCOATED
	<b>SEK ART. 5701</b>	STRUCTURE ONLY	3477
	<b>SEK ART. 5716</b>	ø cm 59 ( * )	5489
	<b>SEK ART. 5717</b>	ø cm 69 ( * )	5525
	<b>SEK ART. 5718</b>	ø cm 79 ( * )	5858
	<b>SEK ART. 5713</b>	cm 59 x 59 ( * )	4906
	<b>SEK ART. 5714</b>	cm 69 x 69 ( * )	5180
	<b>SEK ART. 5715</b>	cm 79 x 79 ( * )	5382
* Flipping mechanism			✚ 488

SHIPMENT DETAILS		RESISTANCE TEST	
<b>Art. 5701</b> 1 pz = 1  - kg 6,45/ m³ 0,126	<b>Art. 5713</b> 1 pz = 2  - kg 14,07/ m³ 0,156	• EN 1730:2012 - EN 15372:2016 6.2	• EN 1730:2012 - EN 15372:2016 6.3
<b>Art. 5714</b> 1 pz = 2  - kg 16,86/ m³ 0,166	<b>Art. 5715</b> 1 pz = 2  - kg 20,08/ m³ 0,177	• EN 1730:2012 - EN 15372:2016 6.4.2	• EN 1730:2012 - EN 15372:2016 6.5
<b>Art. 5716</b> 1 pz = 2  - kg 12,95/ m³ 0,156	<b>Art. 5717</b> 1 pz = 2  - kg 15,32/ m³ 0,166	• EN 1730:2012 - EN 15372:2016 6.6	• EN 1730:2012 - EN 15372:2016 7.2
<b>Art. 5718</b> 1 pz = 2  - kg 18,06/ m³ 0,177			
<b>FIRE RETARDANT TEST</b>		<b>TECHNICAL SPECIFICATIONS</b>	

Frame Base



Top

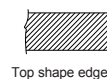

# Yop

Design by Lievore Altherr Molina, 2016

Table with white or black top in Fenix® laminate finish, 2,4 cm thick. Powdercoated aluminum structure fitted with adjustable glides. Available in different shapes: round and square (fixed version or with flipping mechanism). Height 105 cm.

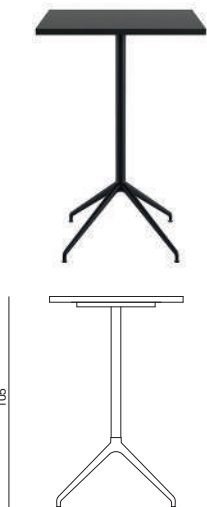

		Top	POWDERCOATED
	<b>SEK ART. 5701</b>	STRUCTURE ONLY	3477
	<b>SEK ART. 5733</b>	∅ cm 59 ( * )	6133
	<b>SEK ART. 5734</b>	∅ cm 69 ( * )	6275
	<b>SEK ART. 5735</b>	∅ cm 79 ( * )	6537
	<b>SEK ART. 5730</b>	cm 59 x 59 ( * )	5228
	<b>SEK ART. 5731</b>	cm 69 x 69 ( * )	5596
	<b>SEK ART. 5732</b>	cm 79 x 79 ( * )	5930
* Flipping mechanism			✚ 488

SHIPMENT DETAILS	RESISTANCE TEST
<b>Art. 5701</b> 1 pz = 1  - kg 6,45/ m³ 0,126 <b>Art. 5730</b> 1 pz = 2  - kg 15,2/ m³ 0,156 <b>Art. 5731</b> 1 pz = 2  - kg 18,41/ m³ 0,166 <b>Art. 5732</b> 1 pz = 2  - kg 22,11/ m³ 0,177 <b>Art. 5733</b> 1 pz = 2  - kg 13,84/ m³ 0,156 <b>Art. 5734</b> 1 pz = 2  - kg 16,54/ m³ 0,166 <b>Art. 5735</b> 1 pz = 2  - kg 19,66/ m³ 0,177	
<b>FIRE RETARDANT TEST</b>	<b>TECHNICAL SPECIFICATIONS</b>

Frame Base



Top

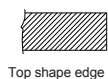
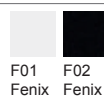

# Yop

Design by Lievore Altherr Molina, 2016

Table with white or black top in Compact HPL, 1 cm thick.  
Powdercoated aluminum structure fitted with adjustable glides.  
Available in different shapes: round and square (fixed version or with flipping mechanism). Height 103.5 cm.

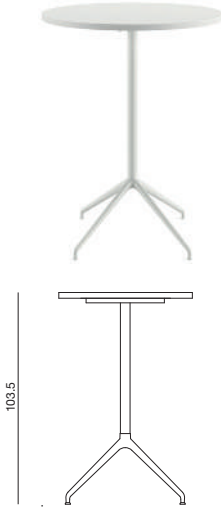

		Top	POWDERCOATED
	<b>SEK ART. 5701</b>	STRUCTURE ONLY	3477
	<b>SEK ART. 5750</b>	∅ cm 59 ( * )	5477
	<b>SEK ART. 5751</b>	∅ cm 69 ( * )	6430
	<b>SEK ART. 5752</b>	∅ cm 79 ( * )	6799
	<b>SEK ART. 5747</b>	cm 59 x 59 ( * )	5477
	<b>SEK ART. 5748</b>	cm 69 x 69 ( * )	6430
	<b>SEK ART. 5749</b>	cm 79 x 79 ( * )	6799
* Flipping mechanism			+ 488
Outdoor powdercoated			+ 95

SHIPMENT DETAILS	RESISTANCE TEST
<b>Art. 5701</b> 1 pz = 1  - kg 6,45/ m³ 0,126 <b>Art. 5747</b> 1 pz = 2  - kg 13,86/ m³ 0,156 <b>Art. 5748</b> 1 pz = 2  - kg 16,57/ m³ 0,166 <b>Art. 5749</b> 1 pz = 2  - kg 19,7/ m³ 0,177 <b>Art. 5750</b> 1 pz = 2  - kg 12,78/ m³ 0,156 <b>Art. 5751</b> 1 pz = 2  - kg 15,1/ m³ 0,166 <b>Art. 5752</b> 1 pz = 2  - kg 17,77/ m³ 0,177	<ul style="list-style-type: none"> <li>• EN 1730:2012 - EN 15372:2016 6.2</li> <li>• EN 1730:2012 - EN 15372:2016 6.4.2</li> <li>• EN 1730:2012 - EN 15372:2016 6.3</li> <li>• EN 1730:2012 - EN 15372:2016 6.5</li> </ul>
<b>TECHNICAL SPECIFICATIONS</b>	
<b>FIRE RETARDANT TEST</b>	

Frame Base



Top

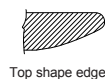

# PANELS AND --- FURNISHINGS

---

# Panels

Panels Arper Grade	Supplier	Collection	Upholstery Code	Program
A	Camira	Era	ER	Graded In
A	Camira	Phoenix	PH	Carded In
A	FiDiVi.	Jet	JE	Carded In
A	Gabriel	Fighter	FH	Graded In
B	Camira	Urban	UP	Carded In
B	Camira	Xtreme	XP	Graded In
B	Gabriel	Atlantic	AT	Graded In
B	Gabriel	Medley	MY	Graded In
B	Gabriel	Step	S1	Graded In
B	Gabriel	Step Melange	SM	Graded In
B	Kvadrat	Field 2	FI	Carded In
B	Kvadrat	Revive 1	R1	Carded In
C	Camira	Main Line Flax	MF	Carded In
C	Camira	Synergy	SN	Carded In
C	Gabriel	Fame	FA	Graded In
C	Kvadrat	Floyd	F1	Carded In
C	Kvadrat	Remix 3	RX	Carded In
D	Gabriel	Crisp	CR	Graded In
D	Kvadrat	Canvas 2	CV	Carded In
D	Kvadrat	Clara 2	CL	Graded In
D	Maharam	Messenger	MS	Carded In
E	Camira	Blazer	BL	Graded In
E	Kvadrat	Re-wool	RW	Carded In
F	Kvadrat	Fiord 2	FD	Carded In
F	Kvadrat	Tonus 4	T3	Carded In
G	Kvadrat	Divina 3	DV	Carded In
G	Kvadrat	Divina MD	DI	Carded In
G	Kvadrat	Divina Melange 3	DM	Carded In
G	Kvadrat	Jaali	JA	Carded In
G	Kvadrat	Savanna	SA	Graded In
G	Kvadrat	Steelcut 3	SE	Carded In
G	Kvadrat	Steelcut Trio 3	ST	Carded In
G (*)	Kvadrat	Hallingdal 65	HA	Carded In
I	Kvadrat	Balder 3	B1	Carded In
I	Kvadrat	Tonica 2	TN	Graded In
J	Kvadrat	Vidar 4	VD	Carded In
COM		COM	COM	

(\*) The Hallingdal 65 fabric is suitable only for Parentesit Wall Collection

# PARAVAN

---

Design by  
Lievore Altherr  
2018

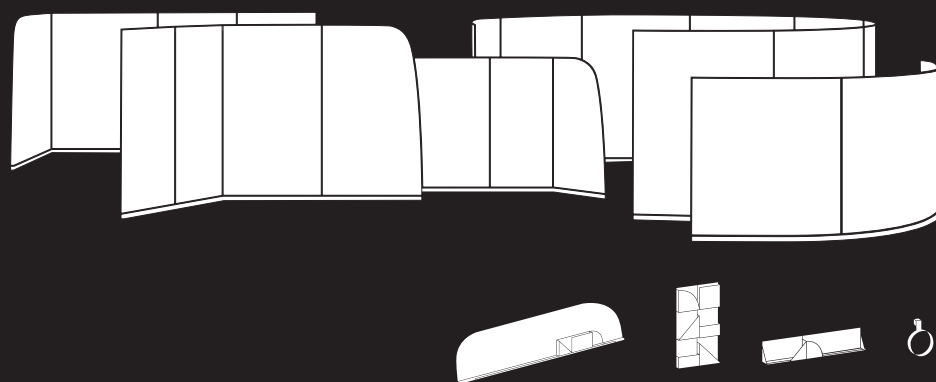

# Paravan

## Collection overview

(For more information please refer to User's Manual downloadable from our website)

Panels available in two heights — h 132,5 cm / 167,5 cm

### Rectangular panels

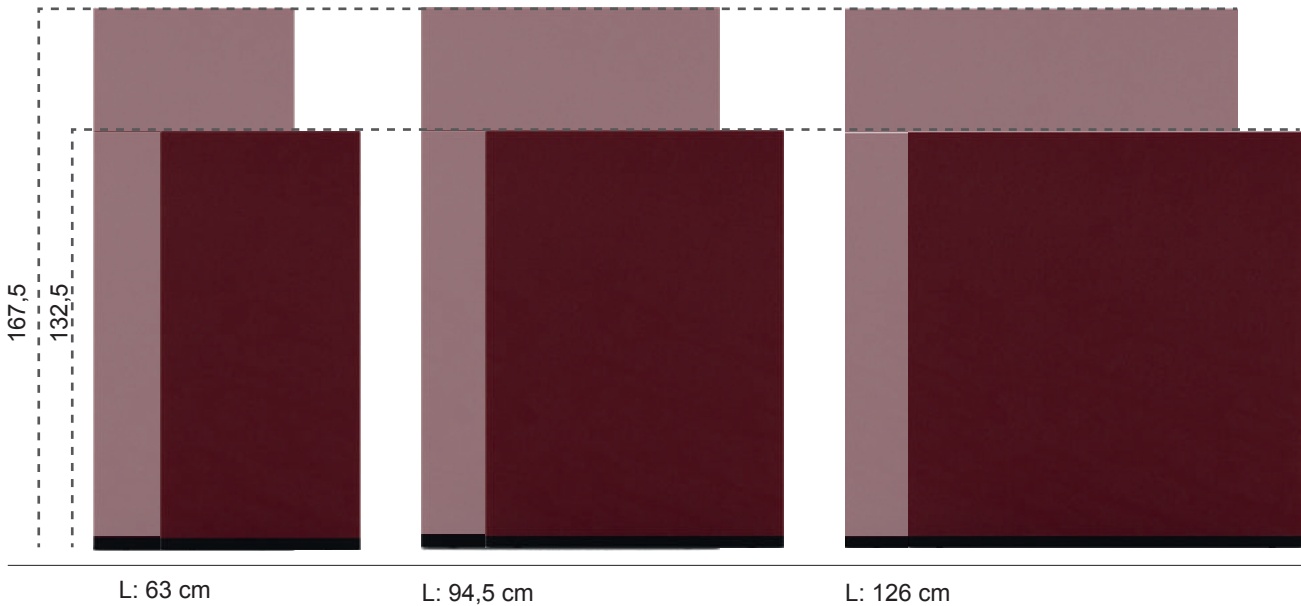

### Rectangular panels with a curved profile

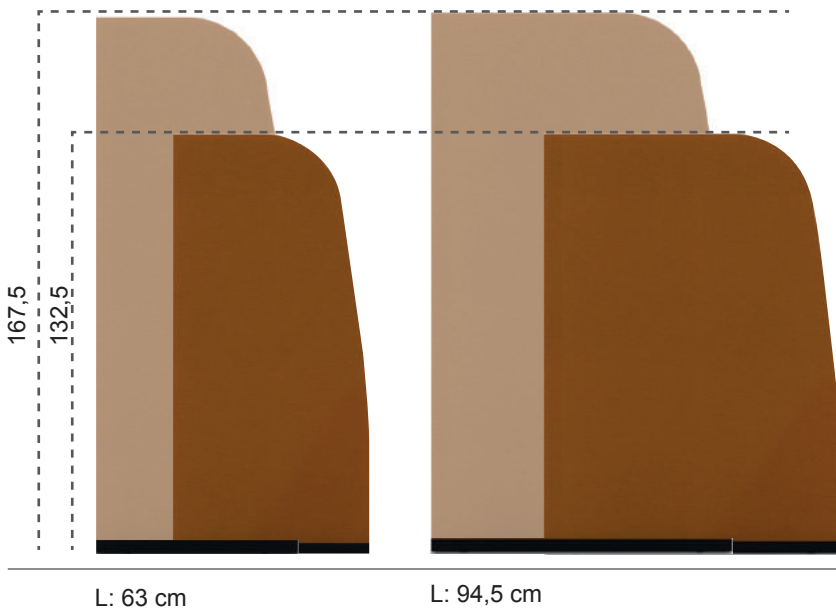

### 90° angular panels

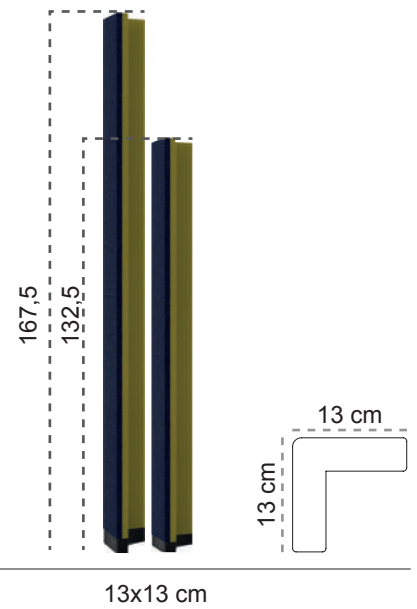

# Paravan

## Curved panel

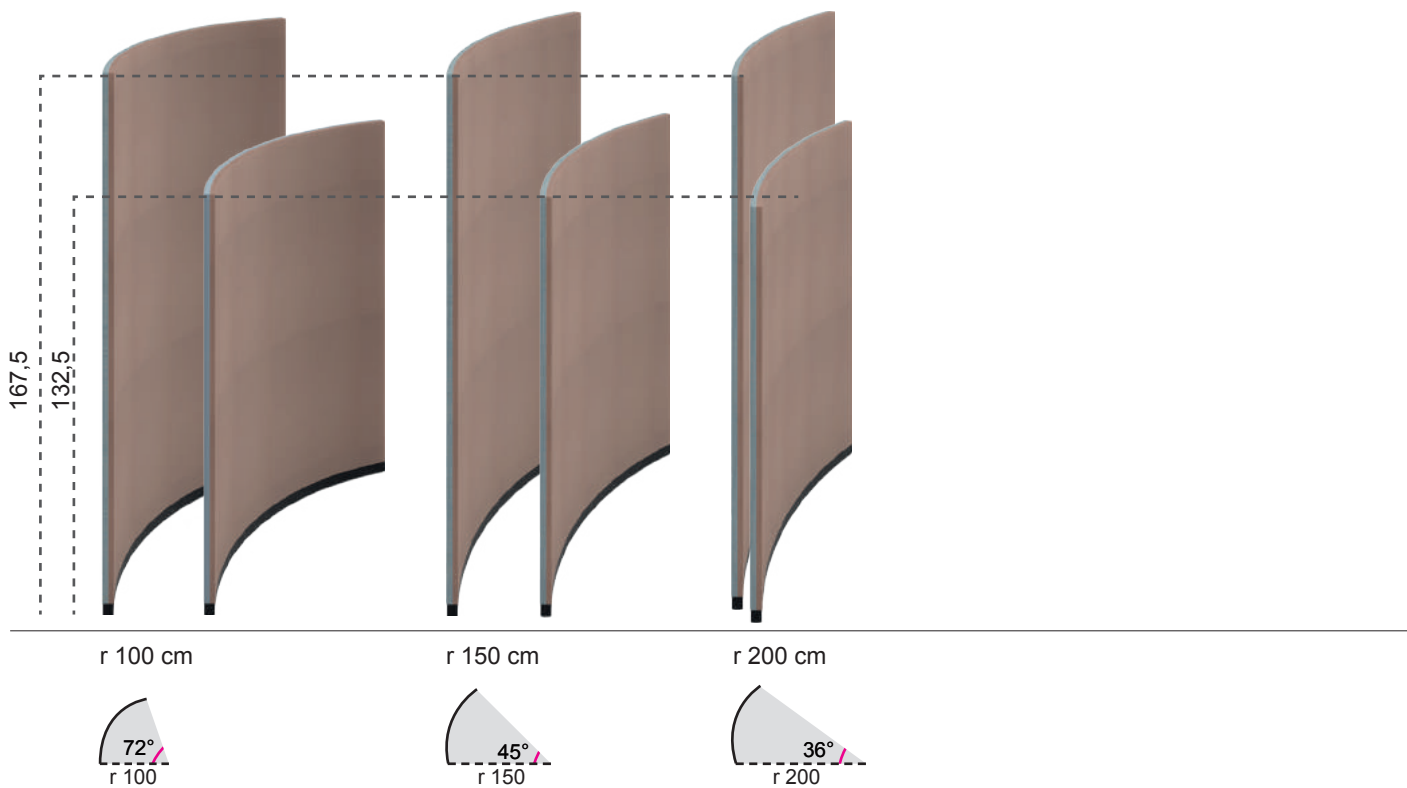

## Cabinet — frame available in two heights — h 132,5 cm / 167,5 cm

The frame must be positioned between two panels of the same height and completed with accessories such as shelves and/or coat racks.

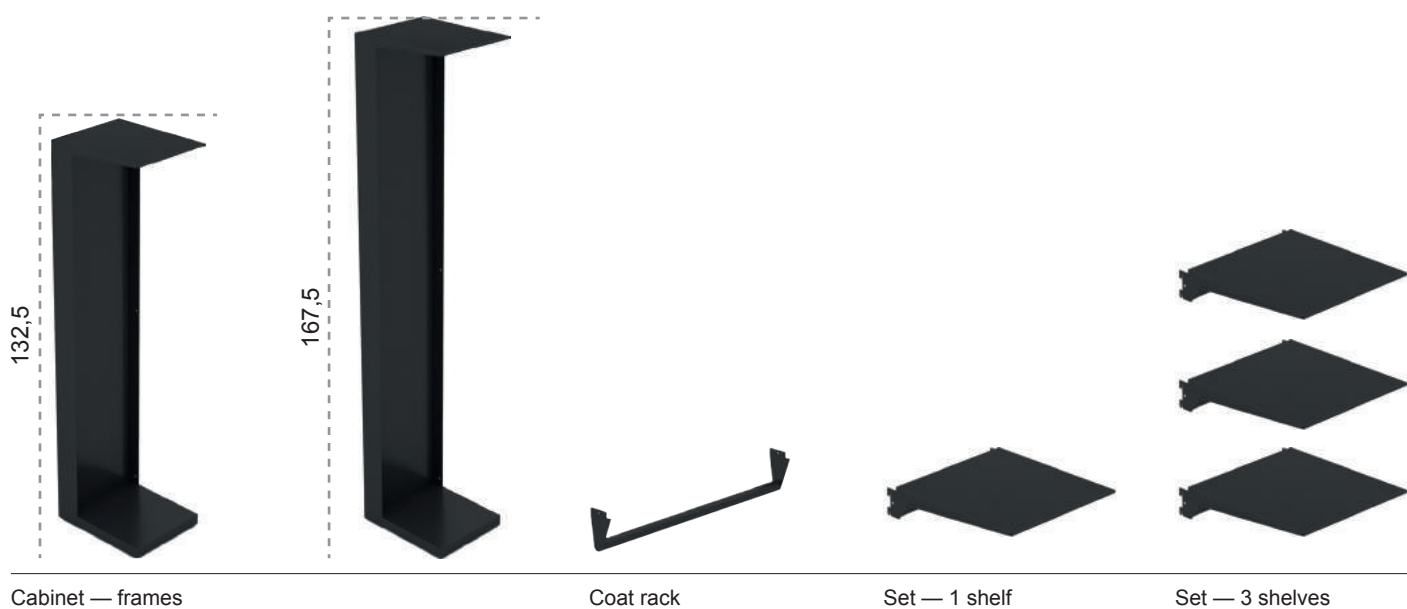



# Paravan

---

## Desk panels



---

Desk panel  
— L 98 cm

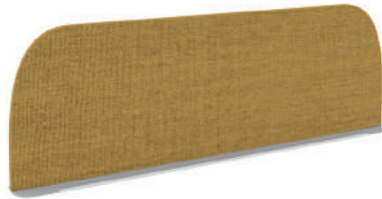

Desk panel  
— L 159 cm

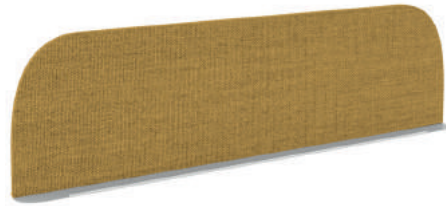

Desk panel  
— L 179 cm

# Paravan

## Two-colour options for all panel versions

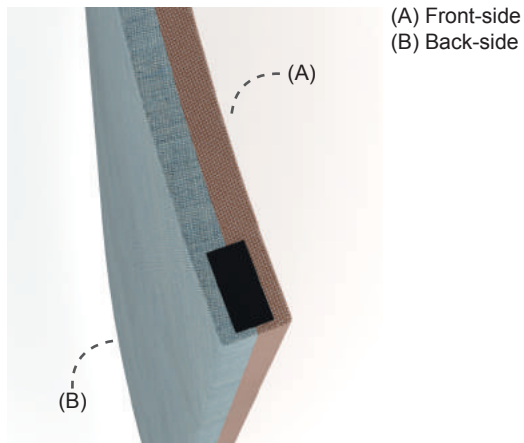

## Two-colour arrangement detail

### Rectangular panels

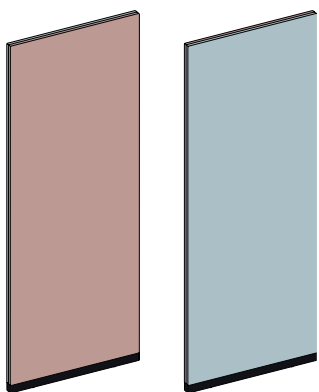

(A) Front-side (B) Back-side

### Rectangular panels with a curved profile

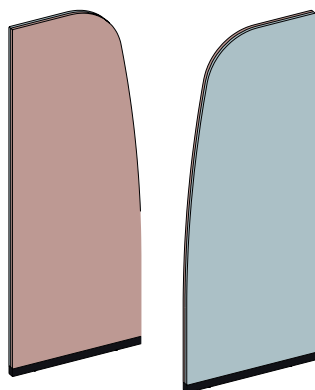

(A) Front-side (B) Back-side

### 90° angular panels

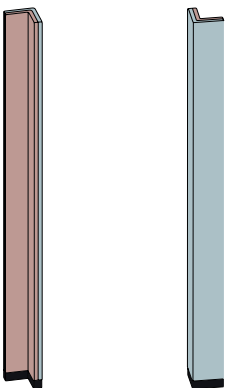

(A) Front-side (B) Back-side

### Curved panel

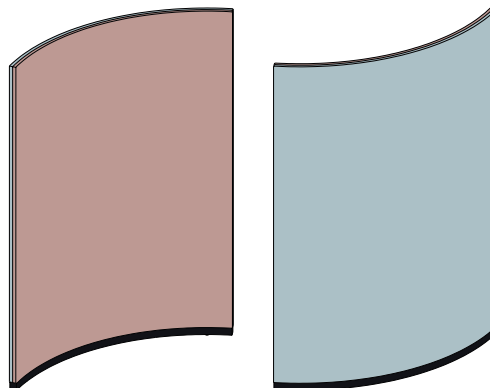

(A) Front-side (B) Back-side

# Paravan

## Connection systems

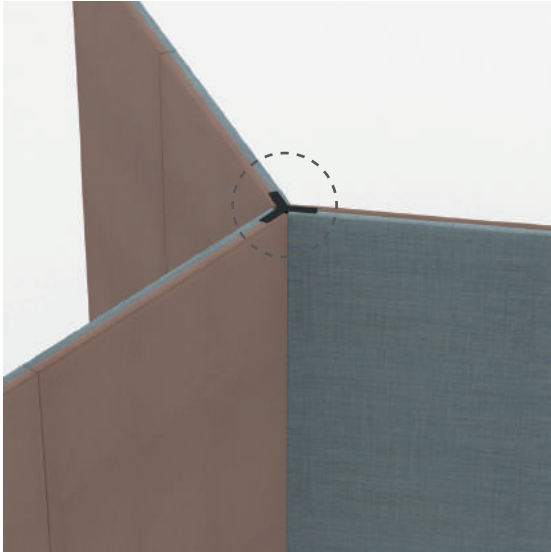

- Connection element with fastening kit for panels:
- 2-way linear link for 180° arrangements, Art. 6423
  - 2-way link for 90° arrangements, "L"-shaped Art. 6424
  - 2-way link for 135° arrangements, "V"-shaped Art. 6425
  - 3-way link for 90° arrangements, "T"-shaped Art. 6426
  - 3-way link for 120° arrangements, "Y"-shaped Art. 6427
  - 4-way link for 90° arrangements, "X"-shaped Art. 6428
  - Link for circular compositions Art. 6431

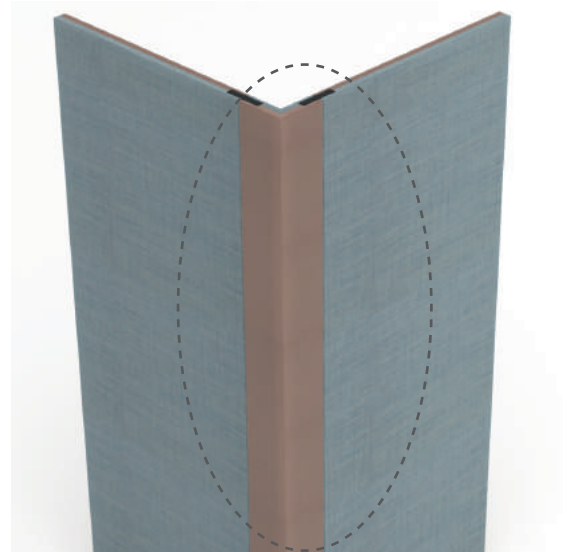

- "Connection element for 90° angular panels:
- 90° angular panels h 132,5 cm Art. 6416
  - 90° angular panels h 167,5 cm Art. 6417

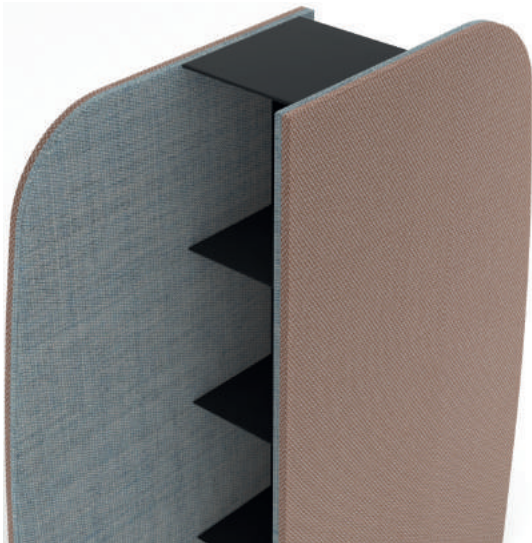

- Connection system for Cabinet:
- Cabinet (frame) h 132,5 Art. 6418
  - Cabinet (frame) h 167,5 Art. 6419

**Tackable when configured  
with proper textile**



# Paravan Mood



Whiteboard

Magazine holder  
— two types

Slim-line shell —  
two types

Organizer

Mirror

Hook

Paravan Mood accessories are the only options for which Arper guarantees combination with Paravan's panels.



# Paravan

## Composition examples

### Linear composition

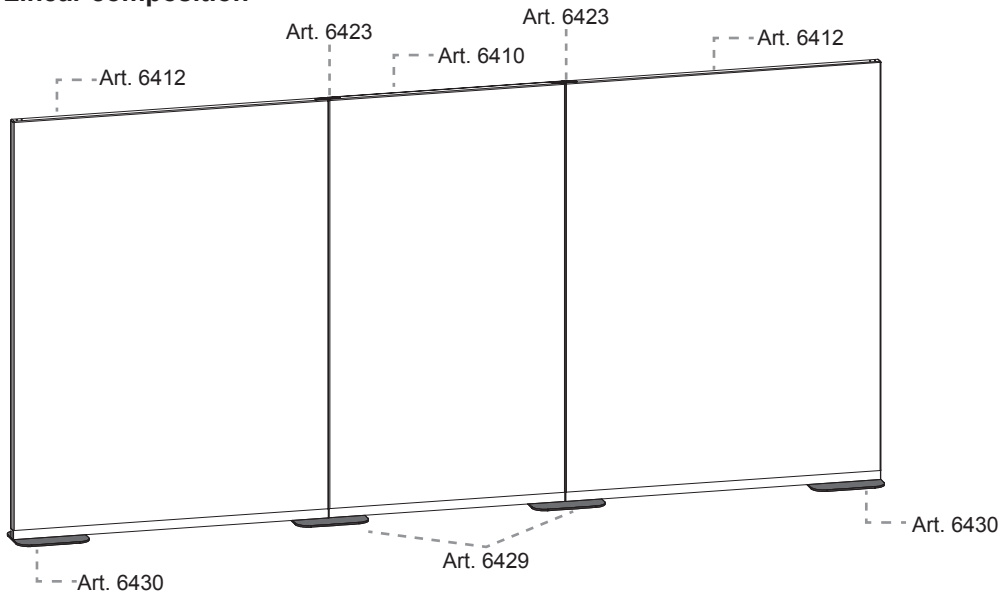

- 2 x Art. 6412 – Rectangular panel, h 167,5 cm width 126 cm
- 1 x Art. 6410 – Rectangular panel, h 167,5 cm width 94,5 cm
- 2 x Art. 6423 – 2-way linear link for 180° arrangements
- 2 x Art. 6430 – Single standard fixing plate
- 2 x Art. 6429 – Connection fixing plate

### 120° arrangement composition

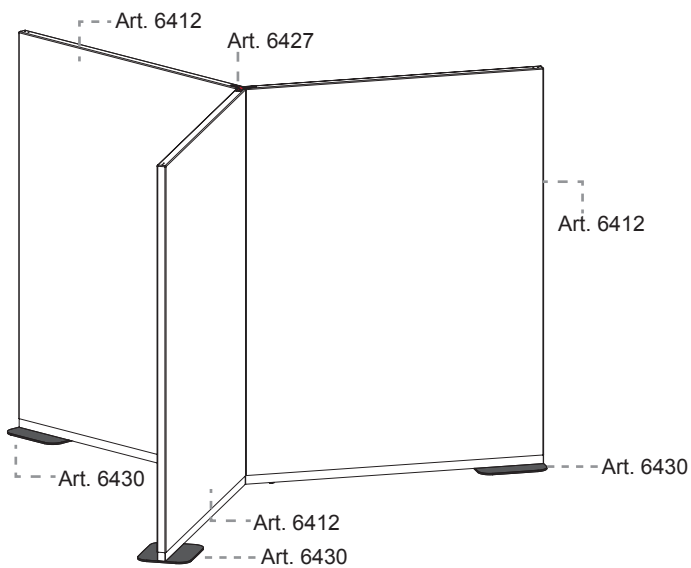

- 3 x Art. 6412 – Rectangular panel h 167,5 cm width 126 cm
- 1 x Art. 6427 – 3-way link for 120° arrangements, “Y”-shaped
- 3 x Art. 6430 – Single standard fixing plate

# Paravan

## 135° arrangement composition

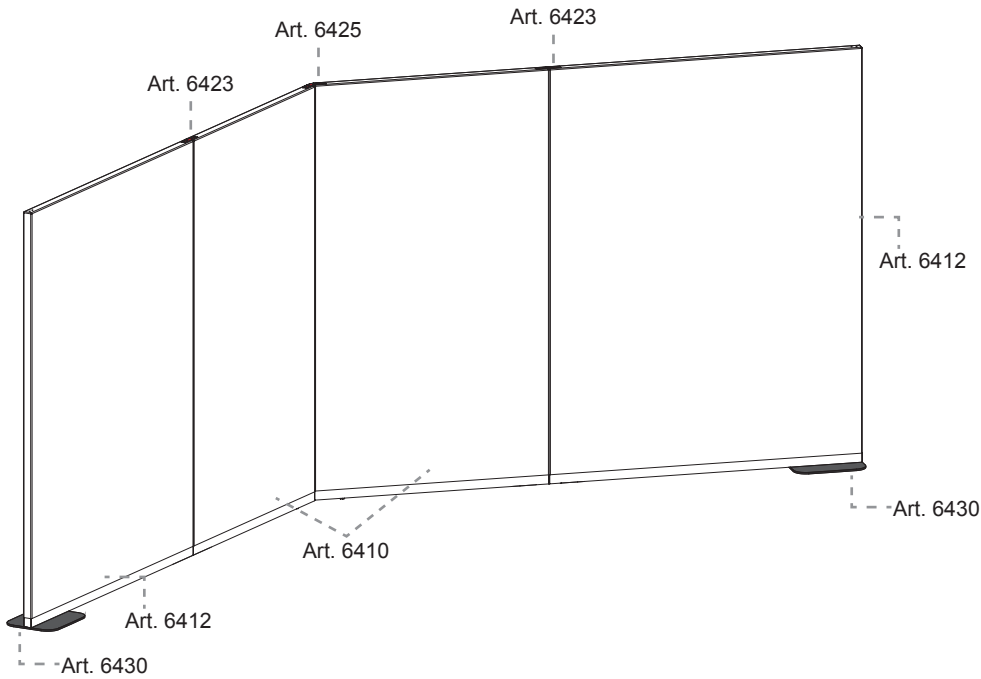

- 2 x Art. 6412 – Rectangular panel h 167,5 cm, width 126 cm
- 2 x Art. 6410 – Rectangular panel h 167,5 cm, width 94,5 cm
- 2 x Art. 6423 – 2-way linear link for 180° arrangements
- 1 x Art. 6425 – 2-way link for 135° arrangements, “V”-shaped
- 2 x Art. 6430 – Single standard fixing plate

## 4-way composition

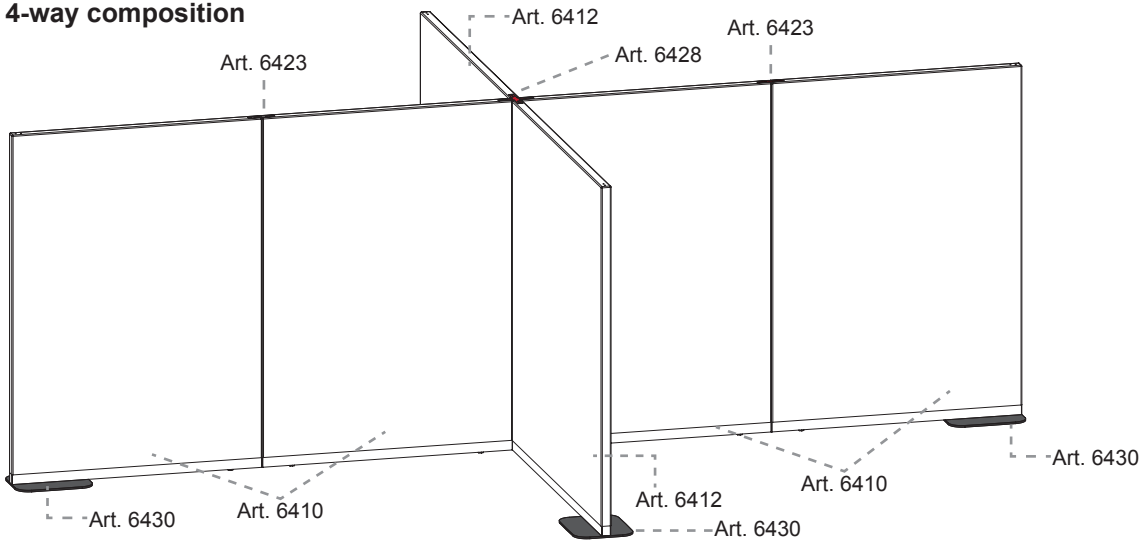

- 2 x Art. 6412 – Rectangular panel h 167,5 cm, width 126 cm
- 4 x Art. 6410 – Rectangular panel h 167,5 cm, width 126 cm
- 1 x Art. 6428 – 4-way link for 90° arrangements, X-shaped
- 4 x Art. 6430 – Single standard fixing plate
- 2 x Art. 6423 – 2-way linear link for 180° arrangements

# Paravan

## Circular composition

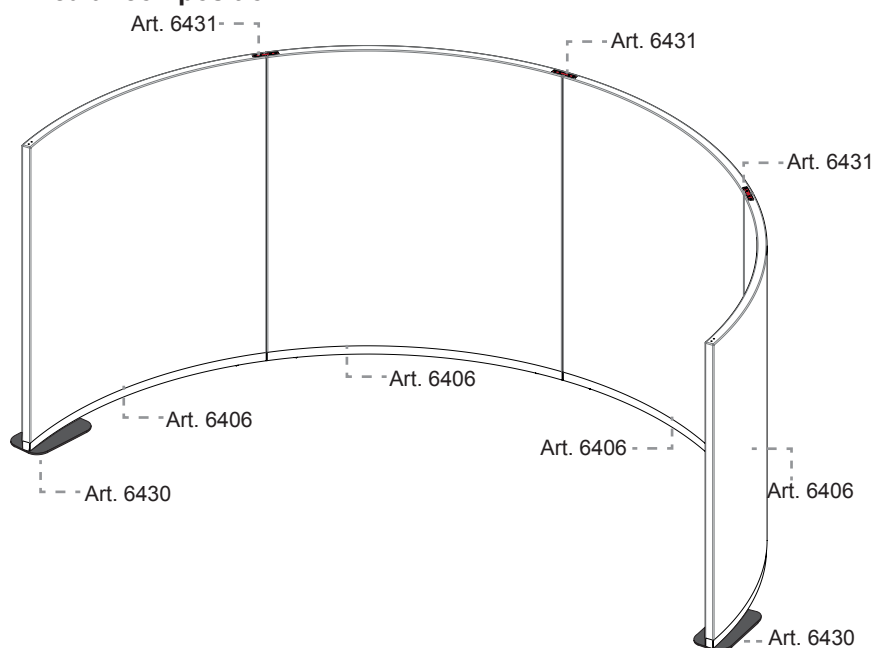

- 4 x Art. 6406 – Curved panel h 132,5 cm, radius 150 cm, width 114,5 cm
- 3 x Art. 6431 – Link for circular composition

## Linear-circular composition

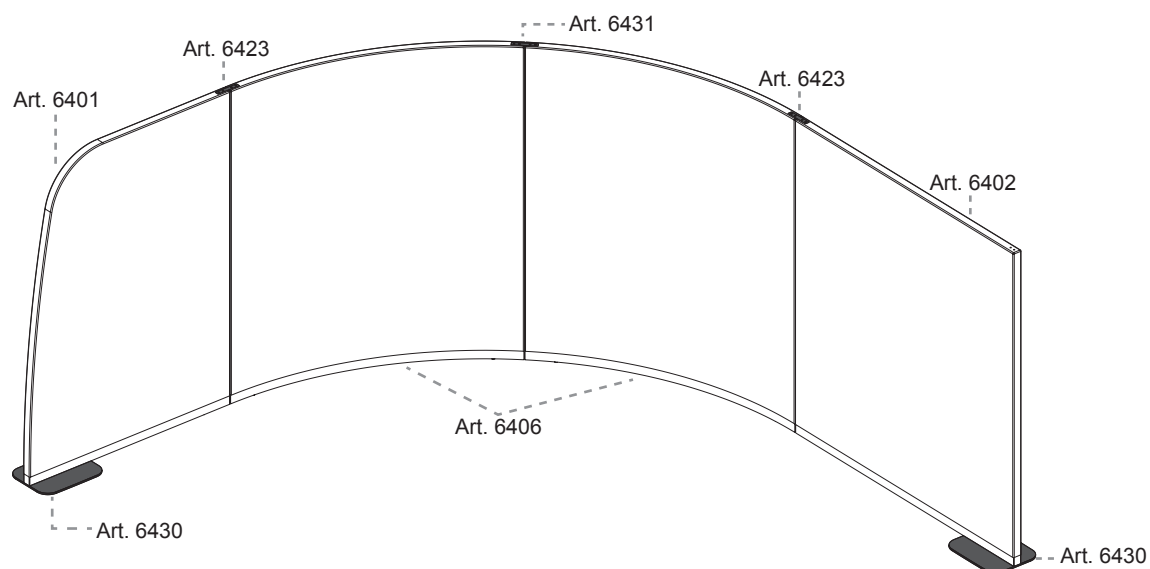

- 2 x Art. 6406 – Curved panel h 132,5 cm, radius 150 cm, width 114,5 cm
- 1 x Art. 6401 – Rectangular panel with 1 curved profile h 132,5 cm width 63 cm
- 1 x Art. 6402 – Rectangular panel h 132,5 cm width 94,5 cm
- 1 x Art. 6431 – Link for circular composition
- 2 x Art. 6430 – Single standard fixing plate
- 2 x Art. 6423 – 2-way linear link for 180° arrangements

# Paravan

## Double L-shape composition

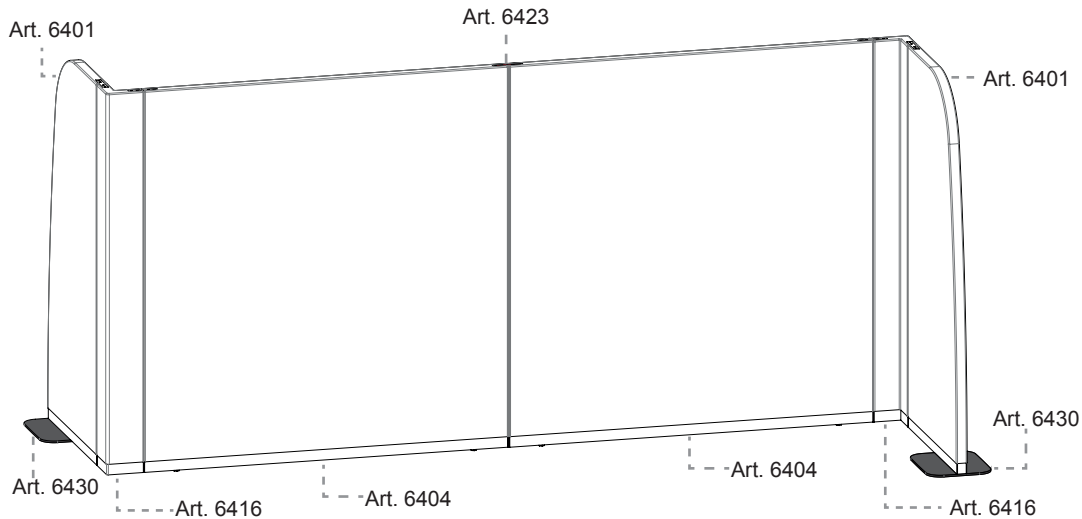

- 2 x Art. 6404 – Rectangular panel h 132,5 cm width 126 cm
- 2 x Art. 6401 – Rectangular panel with 1 curved profile h 132,5 cm width 63 cm
- 2 x Art. 6416 – 90° angular panel h 132,5 cm
- 1 x Art. 6423 – 2-way linear link for 180° arrangements
- 2 x Art. 6430 – Single standard fixing plate

## Double U-shape composition

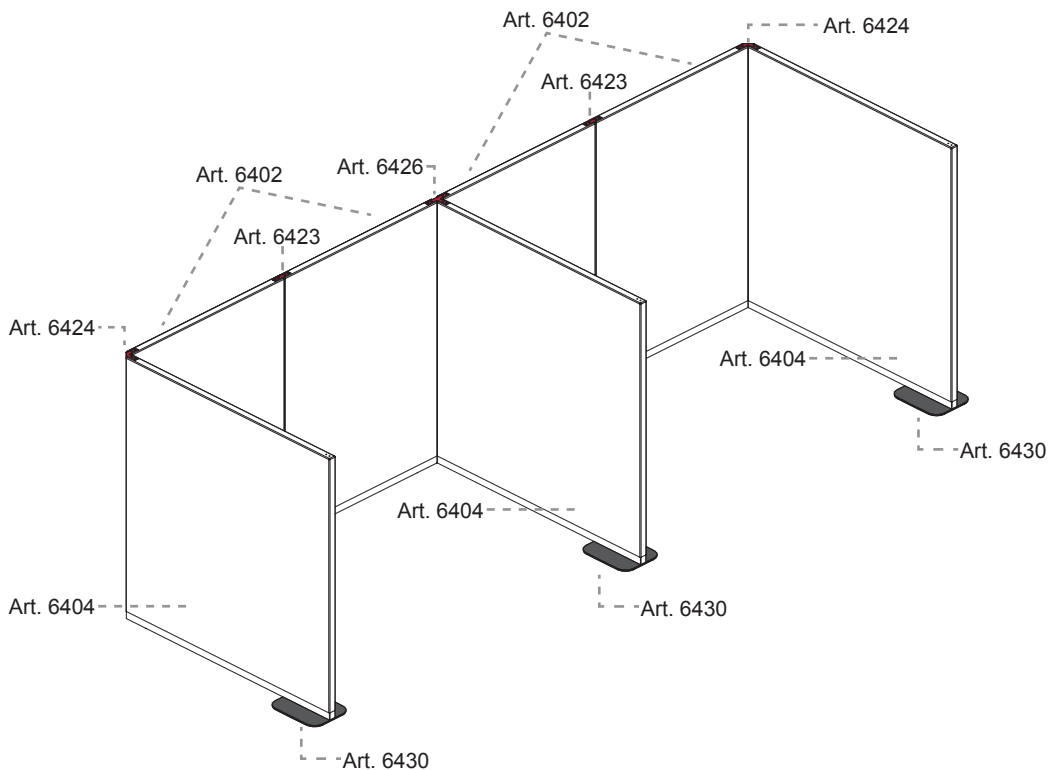

- 4 x Art. 6402 – Rectangular panel h 132,5 cm, width 94.5 cm
- 3 x Art. 6404 – Rectangular panel h 132,5 cm, width 126 cm
- 3 x Art. 6430 – Single standard fixing plate
- 2 x Art. 6423 – 2-way linear link for 180° arrangements
- 2 x Art. 6424 – 2-way link for 90° arrangements, L-shaped
- 1 x Art. 6426 – 3-way link for 90° arrangements, T-shaped



# Paravan

## Linear composition with Cabinet

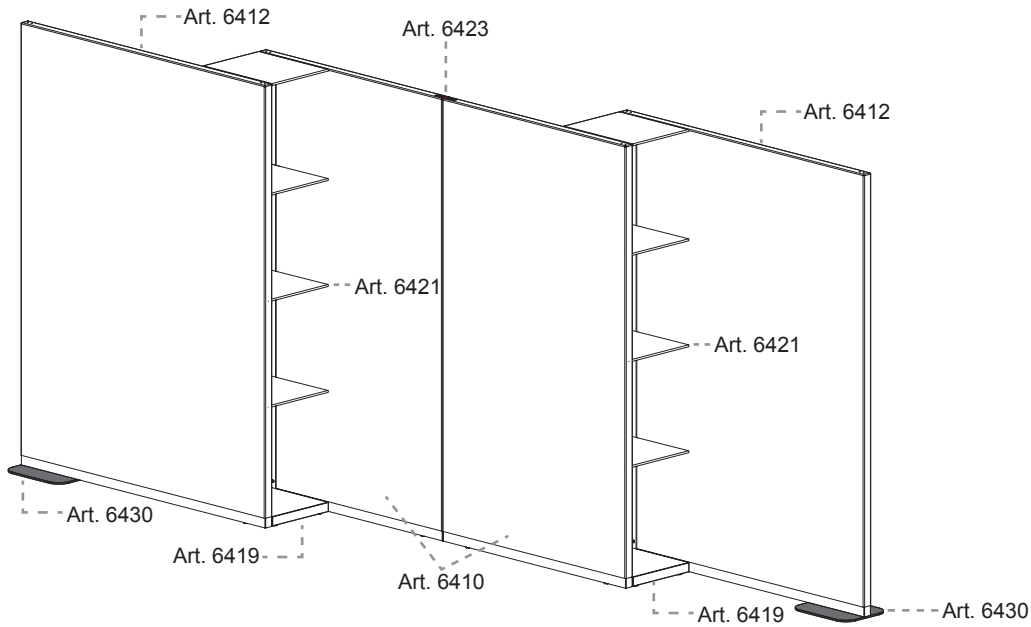

- 2 x Art. 6412 – Rectangular panel, h 167,5 cm width 126 cm
- 2 x Art. 6410 – Rectangular panel, h 167,5 cm width 94.5 cm
- 2 x Art. 6419 – Cabinet frame h 167,5 cm
- 2 x Art. 6421 – Kit 3 shelves
- 1 x Art. 6423 – 2-way linear link for 180° arrangements
- 2 x Art. 6430 – Single standard fixing plate

## Composition examples

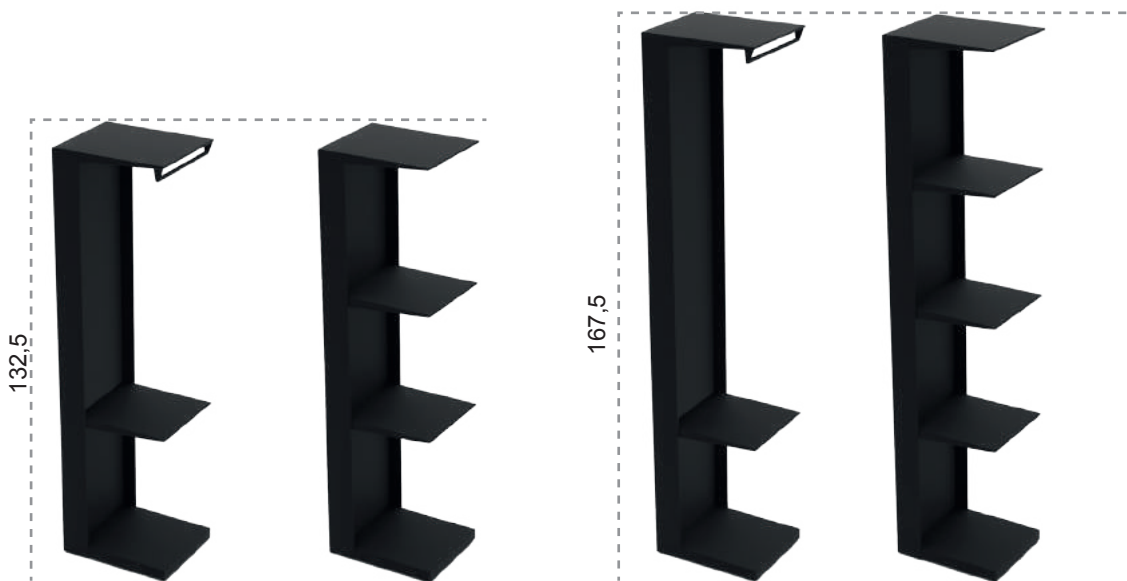

Cabinet h 132,5 cm with  
— no.1 set of 3 shelves  
— no. 1 Coat rack

Cabinet h 132,5 cm with  
— no. 2 sets of 1 shelf

Cabinet 167,5 cm with  
— no.1 set of 1 shelf  
— coat rack

Cabinet 167,5 cm with  
— no.1 set of 3 shelves

# Paravan

Design by Lievore Altherr, 2018



132.5 cm high rectangular panel available in three widths – 63, 94.5 and 126 cm – and upholstered in one colour fabric. The acoustic panel is available with a two colour upholstery upon request and with a surcharge. The base is in black aluminium. Fixing plate and linking elements are supplied separately for the creation of modular compositions.

**Accessories:**

Cabinet H132,5 cm Art. 6418  
 3-way link Art. 6426  
 Single standard fixing plate Art. 6430  
 Slim-line shelf L 63 cm Art. 6435  
 Side XL-plates Art. 6449

2-way link Art. 6423  
 3-way link Art. 6427  
 Whiteboard Art. 6432  
 Slim-line shelf L 94.5 cm Art. 6436

2-way link Art. 6424  
 4-way link Art. 6428  
 Magazine holder Art. 6433  
 Mirror Art. 6437

2-way link Art. 6425  
 Connection fixing plate Art. 6429  
 Magazine holder Art. 6434  
 Hook Art. 6438

SEK ART. 6400	A	B COM	C	D	E	F	G	H	I	J	K	L	M
L 63 cm	7430	7847	8264	8681	9098	9515	9932	10349	10766	11183	11600	12017	12434
SEK ART. 6402	A	B COM	C	D	E	F	G	H	I	J	K	L	M
L 94,5 cm	9085	9907	10729	11551	12373	13195	14017	14839	15661	16483	17305	18127	18949
SEK ART. 6404	A	B COM	C	D	E	F	G	H	I	J	K	L	M
L 126 cm	10395	11359	12323	13287	14251	15215	16179	17143	18107	19071	20035	20999	21963
Upholstered with a single material in two colors	+ 274		qty min. 2 pcs										

SHIPMENT DETAILS	TECHNICAL SPECIFICATIONS	RESISTANCE TEST
<p><b>Art. 6400</b>                      1 pz = 1  - kg 13,65/ m³ 0,068</p> <p><b>Art. 6402</b>                      1 pz = 1  - kg 18,46/ m³ 0,101</p> <p><b>Art. 6404</b>                      1 pz = 1  - kg 23,4/ m³ 0,133</p>	<p><b>Art.6400</b>                      H 140 cm. COM Meterage m 1.57                      *Classe 1, 2, 1IM: fire retardant version available with surcharge and eventual minimum batch</p> <p><b>Art.6402</b>                      H 140 cm. COM Meterage m 3.01                      *Classe 1, 2, 1IM: fire retardant version available with surcharge and eventual minimum batch</p> <p><b>Art.6404</b>                      H 140 cm. COM Meterage m 3.01                      *Classe 1, 2, 1IM: fire retardant version available with surcharge and eventual minimum batch</p>	
<p><b>FIRE RETARDANT TEST</b>                      Classe 1 Omologazione Italia Field Kvadrat.</p>		

Frame Base



V39  
matt



# Paravan

Design by Lievore Altherr, 2018

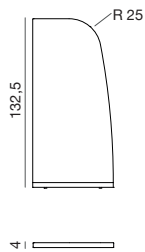

132.5 cm high rectangular panel with a curved profile, to be used to start or finish the composition, available in two widths – 63 and 94.5 cm – and upholstered in one colour fabric. The acoustic panel is available with a two colour upholstery upon request and with a surcharge. The base is in black aluminium. Fixing plate and linking elements are supplied separately for the creation of modular compositions.

**Accessories:**

Cabinet H132,5 cm Art. 6418  
 3-way link Art. 6426  
 Single standard fixing plate Art. 6430  
 Slim-line shelf L 63 cm Art. 6435  
 Side XL-plates Art. 6449

2-way link Art. 6423  
 3-way link Art. 6427  
 Whiteboard Art. 6432  
 Slim-line shelf L 94.5 cm Art. 6436

2-way link Art. 6424  
 4-way link Art. 6428  
 Magazine holder Art. 6433  
 Mirror Art. 6437

2-way link Art. 6425  
 Connection fixing plate Art. 6429  
 Magazine holder Art. 6434  
 Hook Art. 6438

SEK ART. 6401	A	B COM	C	D	E	F	G	H	I	J	K	L	M
L 63 cm	7430	7847	8264	8681	9098	9515	9932	10349	10766	11183	11600	12017	12434
SEK ART. 6403	A	B COM	C	D	E	F	G	H	I	J	K	L	M
L 94,5 cm	9085	9907	10729	11551	12373	13195	14017	14839	15661	16483	17305	18127	18949
Upholstered with a single material in two colors	+ 274 qty min. 2 pcs												

SHIPMENT DETAILS	TECHNICAL SPECIFICATIONS	RESISTANCE TEST
<b>Art. 6401</b> 1 pz = 1  - kg 13/ m <sup>2</sup> 0,068 <b>Art. 6403</b> 1 pz = 1  - kg 16,9/ m <sup>2</sup> 0,101	<b>Art.6401</b> H 140 cm. COM Meterage m 1.57 *Classe 1, 2, 1IM: fire retardant version available with surcharge and eventual minimum batch <b>Art.6403</b> H 140 cm. COM Meterage m 3.01 *Classe 1, 2, 1IM: fire retardant version available with surcharge and eventual minimum batch	
<b>FIRE RETARDANT TEST</b> Classe 1 Omologazione Italia Field Kvadrat.		

Frame Base



# Paravan

Design by Lievore Altherr, 2018

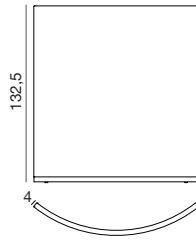

132.5 cm high curved panel available in three radius options – 100, 150 and 200 cm – and upholstered in one colour fabric. The acoustic panel is available with a two colour upholstery upon request and with a surcharge. The base is in black aluminium. Fixing plate and linking elements are supplied separately for the creation of modular compositions.

**Accessories:**

Connection fixing plate Art. 6429  
Magazine holder Art. 6434

Single standard fixing plate Art. 6430  
Mirror Art. 6437

Link for circular composition Art. 6431 Magazine holder Art. 6433  
Hook Art. 6438

<b>SEK ART. 6405</b>	A	B COM	C	D	E	F	G	H	I	J	K	L	M
r 100 cm - 72°	11966	12788	13610	14432	15254	16076	16898	17720	18542	19364	20186	21008	21830
<b>SEK ART. 6406</b>	A	B COM	C	D	E	F	G	H	I	J	K	L	M
r 150 cm - 45°	11966	12788	13610	14432	15254	16076	16898	17720	18542	19364	20186	21008	21830
<b>SEK ART. 6407</b>	A	B COM	C	D	E	F	G	H	I	J	K	L	M
r 200 cm - 36°	11966	12788	13610	14432	15254	16076	16898	17720	18542	19364	20186	21008	21830
Upholstered with a single material in two colors	+ 274		qty min. 2 pcs										

SHIPMENT DETAILS	TECHNICAL SPECIFICATIONS	RESISTANCE TEST
<b>Art. 6405</b> 1 pz = 1  - kg 24,7/ m³ 0,621 <b>Art. 6406</b> 1 pz = 1  - kg 20,8/ m³ 0,621 <b>Art. 6407</b> 1 pz = 1  - kg 18,2/ m³ 0,621	<b>Art. 6405</b> H 140 cm. COM Meterage m 3.05 *Classe 1, 2, 1IM: fire retardant version available with surcharge and eventual minimum batch <b>Art. 6406</b> H 140 cm. COM Meterage m 3.05 *Classe 1, 2, 1IM: fire retardant version available with surcharge and eventual minimum batch <b>Art. 6407</b> H 140 cm. COM Meterage m 3.05 *Classe 1, 2, 1IM: fire retardant version available with surcharge and eventual minimum batch	
<b>FIRE RETARDANT TEST</b> Classe 1 Omologazione Italia Field Kvadrat.		

Frame Base





# Paravan

Design by Lievore Altherr, 2018

132 cm high metal storage unit, to be positioned between two panels of the same height and to be completed with accessories such as shelves and coat racks.

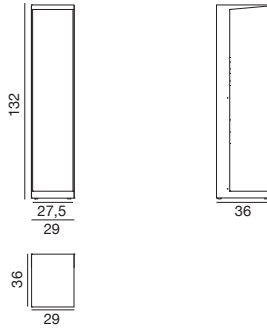

Accessories:  
Set - 1 shelf Art. 6420

Set - 3 shelves Art. 6421

Coat rack Art. 6422

<b>SEK ART. 6418</b>	-	
Cabinet — frame h 132,5	7299	

SHIPMENT DETAILS	TECHNICAL SPECIFICATIONS	RESISTANCE TEST
<b>Art. 6418</b> 1 pz = 1  - kg 29,07/ m³ 0,201		
<b>FIRE RETARDANT TEST</b>		

Frame Base



V39  
matt



# Paravan

Design by Lievore Altherr, 2018

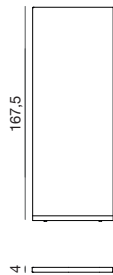

167.5 cm high rectangular panel available in three widths – 63, 94.5 and 126 cm – and upholstered in one colour fabric. The acoustic panel is available with a two colour upholstery upon request and with a surcharge. The base is in black aluminium. Fixing plate and linking elements are supplied separately for the creation of modular compositions.

**Accessories:**

Cabinet H167,5 cm Art. 6419  
 3-way link Art. 6426  
 Single standard fixing plate Art. 6430  
 Slim-line shelf L 63 cm Art. 6435  
 Side XL-plates Art. 6449

2-way link Art. 6423  
 3-way link Art. 6427  
 Whiteboard Art. 6432  
 Slim-line shelf L 94.5 cm Art. 6436

2-way link Art. 6424  
 4-way link Art. 6428  
 Magazine holder Art. 6433  
 Mirror Art. 6437

2-way link Art. 6425  
 Connection fixing plate Art. 6429  
 Magazine holder Art. 6434  
 Hook Art. 6438

SEK ART. 6408	A	B COM	C	D	E	F	G	H	I	J	K	L	M
L 63 cm	8799	9216	9633	10050	10467	10884	11301	11718	12135	12552	12969	13386	13803
SEK ART. 6410	A	B COM	C	D	E	F	G	H	I	J	K	L	M
L 94,5 cm	10729	11551	12373	13195	14017	14839	15661	16483	17305	18127	18949	19771	20593
SEK ART. 6412	A	B COM	C	D	E	F	G	H	I	J	K	L	M
L 126 cm	11966	12930	13894	14858	15822	16786	17750	18714	19678	20642	21606	22570	23534
Upholstered with a single material in two colors	+ 417		qty min. 2 pcs										

SHIPMENT DETAILS	TECHNICAL SPECIFICATIONS	RESISTANCE TEST
<b>Art. 6408</b> 1 pz = 1  - kg 16,25/ m² 0,086 <b>Art. 6410</b> 1 pz = 1  - kg 22,1/ m² 0,126 <b>Art. 6412</b> 1 pz = 1  - kg 27,3/ m² 0,167	<b>Art.6408</b> H 140 cm. COM Meterage m 1.93 *Classe 1, 2, 1IM: fire retardant version available with surcharge and eventual minimum batch <b>Art.6410</b> H 140 cm. COM Meterage m 3.81 *Classe 1, 2, 1IM: fire retardant version available with surcharge and eventual minimum batch <b>Art.6412</b> H 140 cm. COM Meterage m 3.81 *Classe 1, 2, 1IM: fire retardant version available with surcharge and eventual minimum batch	• EN 1023-3:2000 6.1 • ANSI BIFMA X5.6-2016/5.3
<b>FIRE RETARDANT TEST</b> Classe 1 Omologazione Italia Field Kvadrat.		

Frame Base



# Paravan

Design by Lievore Altherr, 2018

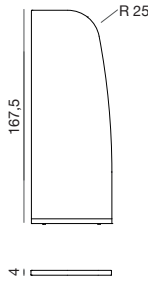

167.5 cm high rectangular panel with a curved profile, to be used to start or finish the composition, available in two widths – 63 and 94.5 cm – and upholstered in one colour fabric. The acoustic panel is available with a two colour upholstery upon request and with a surcharge. The base is in black aluminium. Fixing plate and connection elements are supplied separately for the creation of modular compositions.

**Accessories:**

Cabinet H167,5 cm Art. 6419  
 3-way link Art. 6426  
 Single standard fixing plate Art. 6430  
 Slim-line shelf L 63 cm Art. 6435  
 Side XL-plates Art. 6449

2-way link Art. 6423  
 3-way link Art. 6427  
 Whiteboard Art. 6432  
 Slim-line shelf L 94.5 cm Art. 6436

2-way link Art. 6424  
 4-way link Art. 6428  
 Magazine holder Art. 6433  
 Mirror Art. 6437

2-way link Art. 6425  
 Connection fixing plate Art. 6429  
 Magazine holder Art. 6434  
 Hook Art. 6438

SEK ART. 6409	A	B COM	C	D	E	F	G	H	I	J	K	L	M
L 63 cm	8799	9216	9633	10050	10467	10884	11301	11718	12135	12552	12969	13386	13803
SEK ART. 6411	A	B COM	C	D	E	F	G	H	I	J	K	L	M
L 94,5 cm	10729	11551	12373	13195	14017	14839	15661	16483	17305	18127	18949	19771	20593
Upholstered with a single material in two colors	+ 417 qty min. 2 pcs												

SHIPMENT DETAILS	TECHNICAL SPECIFICATIONS	RESISTANCE TEST
<b>Art. 6409</b> 1 pz = 1  - kg 15,6/ m³ 0,086 <b>Art. 6411</b> 1 pz = 1  - kg 20,8/ m³ 0,126	<b>Art.6409</b> H 140 cm. COM Meterage m 1.93 *Classe 1, 2, 1IM: fire retardant version available with surcharge and eventual minimum batch <b>Art.6411</b> H 140 cm. COM Meterage m 3.81 *Classe 1, 2, 1IM: fire retardant version available with surcharge and eventual minimum batch	
<b>FIRE RETARDANT TEST</b> Classe 1 Omologazione Italia Field Kvadrat.		

Frame Base



V39  
matt





# Paravan

Design by Lievore Altherr, 2018

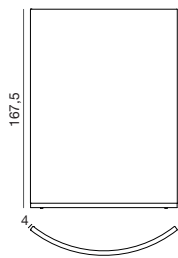

167.5 cm high curved rectangular panel available in three radius options – 100, 150 and 200 cm – and upholstered in one colour fabric. The acoustic panel is available with a two colour upholstery upon request and with a surcharge. The base is in black aluminium. Fixing plate and linking elements are supplied separately for the creation of modular compositions.

**Accessories:**

Connection fixing plate Art. 6429  
Magazine holder Art. 6434

Single standard fixing plate Art. 6430  
Mirror Art. 6437

Link for circular composition Art. 6431 Magazine holder Art. 6433  
Hook Art. 6438

SEK ART. 6413	A	B COM	C	D	E	F	G	H	I	J	K	L	M
r 100 cm - 72 °	13478	14573	15668	16763	17858	18953	20048	21143	22238	23333	24428	25523	26618
SEK ART. 6414	A	B COM	C	D	E	F	G	H	I	J	K	L	M
r 150 cm - 45°	13478	14573	15668	16763	17858	18953	20048	21143	22238	23333	24428	25523	26618
SEK ART. 6415	A	B COM	C	D	E	F	G	H	I	J	K	L	M
r 200 cm - 36°	13478	14573	15668	16763	17858	18953	20048	21143	22238	23333	24428	25523	26618
Upholstered with a single material in two colors	+ 417		qty min. 2 pcs										

SHIPMENT DETAILS	TECHNICAL SPECIFICATIONS	RESISTANCE TEST
<b>Art. 6413</b> 1 pz = 1  - kg 29,9/ m² 0,769 <b>Art. 6414</b> 1 pz = 1  - kg 27,3/ m² 0,769 <b>Art. 6415</b> 1 pz = 1  - kg 23,4/ m² 0,769	<b>Art.6413</b> H 140 cm. COM Meterage m 3.81 *Classe 1, 2, 1IM: fire retardant version available with surcharge and eventual minimum batch <b>Art.6414</b> H 140 cm. COM Meterage m 3.81 *Classe 1, 2, 1IM: fire retardant version available with surcharge and eventual minimum batch <b>Art.6415</b> H 140 cm. COM Meterage m 3.81 *Classe 1, 2, 1IM: fire retardant version available with surcharge and eventual minimum batch	• EN 1023-3:2000 6.1 • ANSI BIFMA X5.6-2016/5.3
<b>FIRE RETARDANT TEST</b> Classe 1 Omologazione Italia Field Kvadrat.		

Frame Base





# Paravan

Design by Lievore Altherr, 2018

167.5 cm high metal storage unit to be positioned between two panels of the same height and to be completed with accessories such as shelves and coat racks.

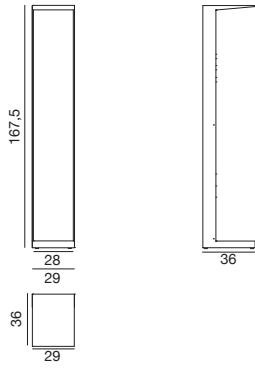

Accessories:  
Set - 1 shelf Art. 6420

Set - 3 shelves Art. 6421

Coat rack Art. 6422

<b>SEK ART. 6419</b>	-	
Cabinet — frame h 167,5	8395	

SHIPMENT DETAILS	TECHNICAL SPECIFICATIONS	RESISTANCE TEST
<b>Art. 6419</b> 1 pz = 1  - kg 36,4/ m³ 0,253		
<b>FIRE RETARDANT TEST</b>		

Frame Base





V39  
matt





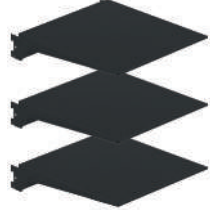

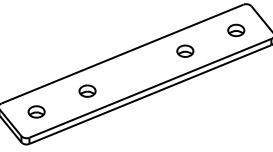
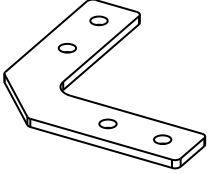
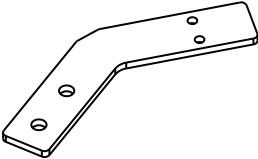
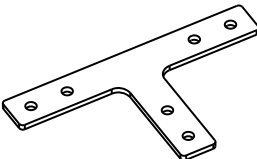
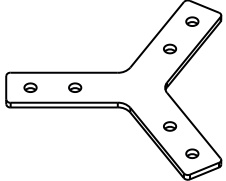
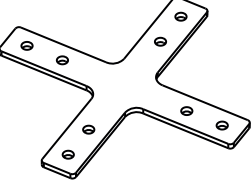
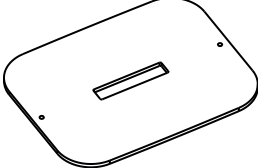
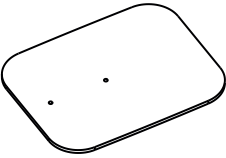
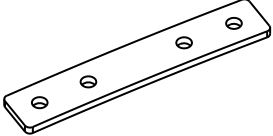
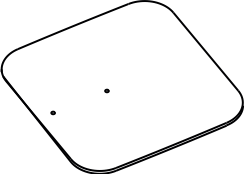







# Accessories

Design by Lievore Altherr, 2018

<p><b>SEK ART. 6420</b></p>  <p>Set - 1 shelf</p> <p>1143</p>	<p><b>SEK ART. 6421</b></p>  <p>Set - 3 shelves</p> <p>2620</p>	<p><b>SEK ART. 6422</b></p>  <p>Coat rack</p> <p>702</p>	<p><b>SEK ART. 6423</b></p>  <p>2-way linear link for 180° arrangements</p> <p>251</p>	<p><b>SEK ART. 6424</b></p>  <p>2-way link for 90° arrangements, "L"-shaped</p> <p>251</p>
<p><b>SEK ART. 6425</b></p>  <p>2-way link for 135° arrangements, "V"-shaped</p> <p>251</p>	<p><b>SEK ART. 6426</b></p>  <p>3-way link for 90° arrangements, "T"-shaped</p> <p>286</p>	<p><b>SEK ART. 6427</b></p>  <p>3-way link for 120° arrangements, "Y"-shaped</p> <p>286</p>	<p><b>SEK ART. 6428</b></p>  <p>4-way link for 90° arrangements, "X"-shaped</p> <p>334</p>	<p><b>SEK ART. 6429</b></p>  <p>Connection fixing plate</p> <p>654</p>
<p><b>SEK ART. 6430</b></p>  <p>Single standard fixing plate 29x22,5 cm</p> <p>654</p>	<p><b>SEK ART. 6431</b></p>  <p>Link for circular compositions</p> <p>251</p>	<p><b>SEK ART. 6449</b></p>  <p>Set of side fixing XL-plates 29x34,5 cm</p> <p>1322</p>		

## SHIPMENT DETAILS

**Art. 6420** 1 pz = 1  - kg 2,6/ m³ 0,015  
**Art. 6422** 1 pz = 1  - kg 0,5/ m³ 0,001  
**Art. 6424** 1 pz = 1  - kg 0,5/ m³ 0,004  
**Art. 6426** 1 pz = 1  - kg 0,5/ m³ 0,004  
**Art. 6428** 1 pz = 1  - kg 0,5/ m³ 0,004  
**Art. 6430** 1 pz = 1  - kg 3,9/ m³ 0,004

**Art. 6421** 1 pz = 1  - kg 7,8/ m³ 0,031  
**Art. 6423** 1 pz = 1  - kg 0,5/ m³ 0,004  
**Art. 6425** 1 pz = 1  - kg 0,5/ m³ 0,004  
**Art. 6427** 1 pz = 1  - kg 0,5/ m³ 0,004  
**Art. 6429** 1 pz = 1  - kg 3,9/ m³ 0,004  
**Art. 6431** 1 pz = 1  - kg 0,5/ m³ 0,004

## TECHNICAL SPECIFICATIONS

## FIRE RETARDANT TEST







# Paravan Desk Panel

Design by Lievore Altherr, 2019

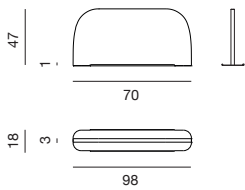
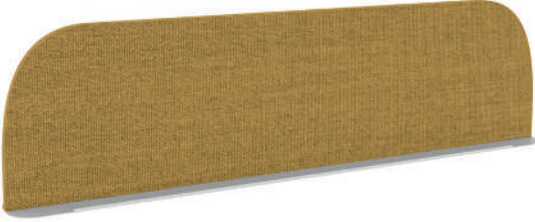
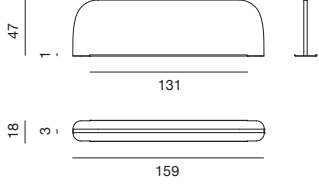
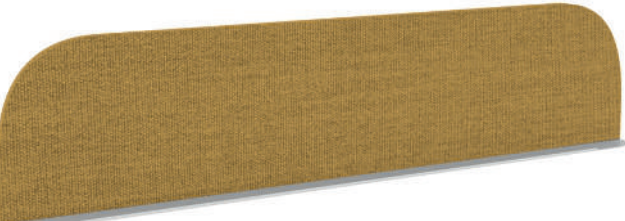
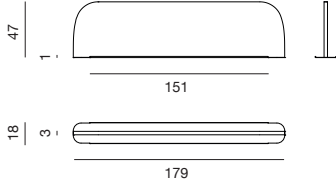
Desk panel available in three widths (98, 159 and 179 cm) and upholstered in fabric. The panel is also available at an additional cost with a two-tone Upholstery. The base is made of powder-coated sheet steel.

Accessories:  
Organizer Art. 6442

<p><b>ART. 6439</b></p> 	
<p><b>ART. 6440</b></p> 	
<p><b>ART. 6441</b></p> 	

SHIPMENT DETAILS	TECHNICAL SPECIFICATIONS	RESISTANCE TEST
<p><b>Art. 6439</b> 1 pz = 1  - kg 9/ m² 0,04</p> <p><b>Art. 6440</b> 1 pz = 1  - kg 14/ m² 0,064</p> <p><b>Art. 6441</b> 1 pz = 1  - kg 17/ m² 0,071</p>	<p><b>Art.6439</b> H 140 cm. COM Meterage m 1.18 *Classe 1, 2, 11M: fire retardant version available with surcharge and eventual minimum batch</p> <p><b>Art.6440</b> H 140 cm. COM Meterage m 1.85 *Classe 1, 2, 11M: fire retardant version available with surcharge and eventual minimum batch</p> <p><b>Art.6441</b> H 140 cm. COM Meterage m 2.07 *Classe 1, 2, 11M: fire retardant version available with surcharge and eventual minimum batch</p>	



# Paravan Desk Panel

Design by Lievore Altherr, 2019

<b>SEK ART. 6439</b>	A	B COM	C COL	D	E	F	G	H	I	J	K	L	M	
Desk Panel L cm 98	3060	3429	3798	4167	4536	4905	5274	5643	6012	6381	6750	7119	7488	
Upholstered with a single material in two colors	+ 274 <b>qty min. 2 pcs</b>													
<b>SEK ART. 6440</b>	A	B COM	C COL	D	E	F	G	H	I	J	K	L	M	
Desk Panel L cm 159	4334	4905	5476	6047	6618	7189	7760	8331	8902	9473	10044	10615	11186	
Upholstered with a single material in two colors	+ 274 <b>qty min. 2 pcs</b>													
<b>SEK ART. 6441</b>	A	B COM	C COL	D	E	F	G	H	I	J	K	L	M	
Desk Panel L cm 179	4893	5536	6179	6822	7465	8108	8751	9394	10037	10680	11323	11966	12609	
Upholstered with a single material in two colors	+ 274 <b>qty min. 2 pcs</b>													
<b>FIRE RETARDANT TEST</b>														
Classe 1 Omologazione Italia Field Kvadrat.														

Frame Base





# Paravan Mood

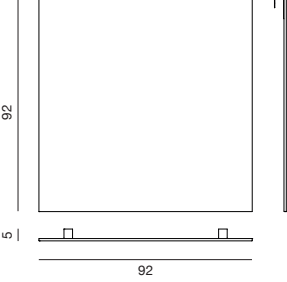

Design by Lievore Altherr, 2019

Whiteboard in steel sheet powder-coated with writable paint (Item 6432) and including kit for fixing to the Paravan panels. The board can be completed with the magnetic pen holder (Item 6448). The board can also be fixed to the wall using the specific optional kit.

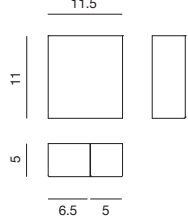
Accessories:  
Pen holder Art. 6448

<p><b>ART. 6432</b></p> 	
<p><b>ART. 6448</b></p> 	

<b>SEK ART. 6432</b>	-	
Whiteboard	2083	
<b>SEK ART. 6448</b>	-	
Pen holder	869	

SHIPMENT DETAILS	TECHNICAL SPECIFICATIONS	RESISTANCE TEST
<p><b>Art. 6432</b> 1 pz = 1  - kg 9,5/ m² 0,07</p> <p><b>Art. 6448</b> 1 pz = 1  - kg 1,5/ m² 0,002</p>		

Frame Base



# Paravan Mood

Design by Lievore Altherr, 2019

Magazine holder in powder-coated steel sheet available in two versions and including kit for fixing to the Paravan panels. Magazine racks can also be fixed to the wall using the specific optional kit.

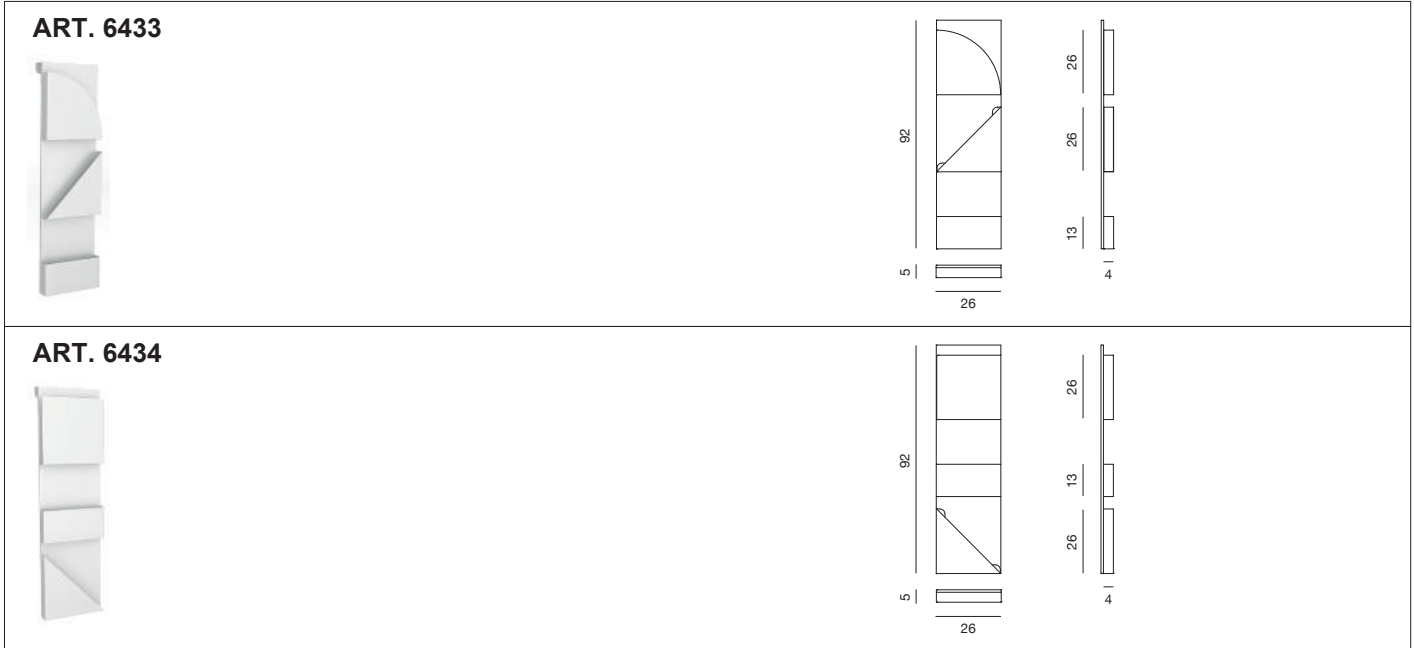

<b>SEK ART. 6433</b>	-	
Magazine holder	2488	
<b>SEK ART. 6434</b>	-	
Magazine holder	2488	

SHIPMENT DETAILS	TECHNICAL SPECIFICATIONS	RESISTANCE TEST
<b>Art. 6433</b> 1 pz = 1  - kg 4,5/ m² 0,019 <b>Art. 6434</b> 1 pz = 1  - kg 4,5/ m² 0,044		

Frame Base





# Paravan Mood

Design by Lievore Altherr, 2019

Shelf in powder-coated sheet steel available in two widths, 63 cm (Item 6435) and 94.5 cm (Item 6436) and including kit for fixing to the Paravan panels. The shelves can also be fixed to the wall using the specific optional kit.

## ART. 6435

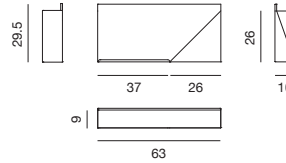
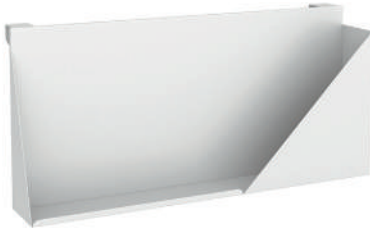

## ART. 6436

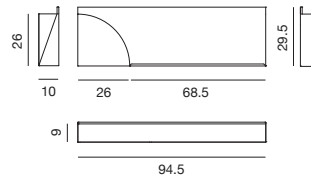

<b>SEK ART. 6435</b>	-	
Slim-line shelf L cm 63	1251	
<b>SEK ART. 6436</b>	-	
Slim-line shelf L cm 94,5	1524	

SHIPMENT DETAILS	TECHNICAL SPECIFICATIONS	RESISTANCE TEST
<b>Art. 6435</b> 1 pz = 1  - kg 4/ m² 0,029 <b>Art. 6436</b> 1 pz = 1  - kg 6/ m² 0,043		

Frame Base







# Paravan Mood

Design by Lievore Altherr, 2019

Mirror (Item 6437) and Pair of hooks (Item 6438) in powder-coated steel sheet to be fixed to the Paravan panels.



<b>SEK ART. 6437</b>	-	
Mirror	1071	
<b>SEK ART. 6438</b>	-	
Hook (2 pieces)	512	

SHIPMENT DETAILS	TECHNICAL SPECIFICATIONS	RESISTANCE TEST
<p><b>Art. 6437</b> 1 pz = 1  - kg 2/ m<sup>2</sup> 0,007</p> <p><b>Art. 6438</b> 1 pz = 1  - kg 1,5/ m<sup>2</sup> 0,004 2 pz = 1  - kg 2/ m<sup>2</sup> 0,004 5 pz = 1  - kg 3/ m<sup>2</sup> 0,004</p>		

Frame Base



# Paravan Mood

Design by Lievore Altherr, 2019

Organizer in powder-coated sheet steel. It can be placed on the base of the desk panels or directly on tables and desks.

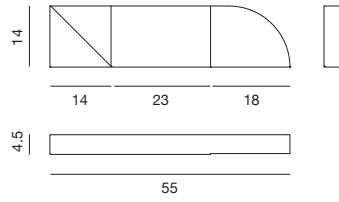

<b>SEK ART. 6442</b>	-	
Organizer	1215	
<b>SHIPMENT DETAILS</b>	<b>TECHNICAL SPECIFICATIONS</b>	<b>RESISTANCE TEST</b>
<b>Art.6442</b> 1 pz = 1  - kg 2,5/ m² 0,005		
<b>FIRE RETARDANT TEST</b>		

Frame Base



# Accessories



Design by Lievore Altherr

## SEK ART. 6443



Wall-mount kit

381

SHIPMENT DETAILS	TECHNICAL SPECIFICATIONS	RESISTANCE TEST
<b>Art. 6443</b> 1 pz = 1  - kg 1,5/ m² 0,004 2 pz = 1  - kg 1,5/ m² 0,004		
<b>FIRE RETARDANT TEST</b>		





# PARENTESIT

---

Design by  
Lievore Altherr Molina  
2015

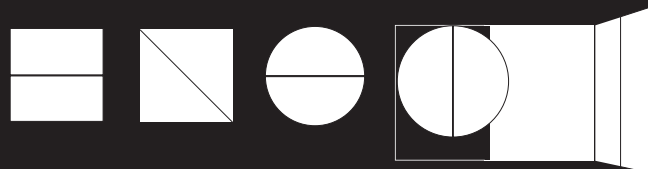

# Parentesit

## Collection overview

### Wall Panel



Square version  
one colour or two colours  
version, with horizontal insert



Square version  
one color or two colors version,  
with diagonal insert

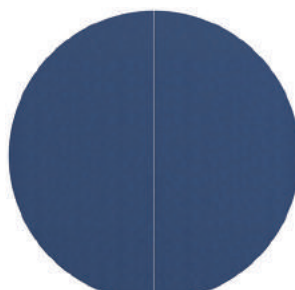

Round version  
one color or two colors version,  
with central insert

### Freestanding

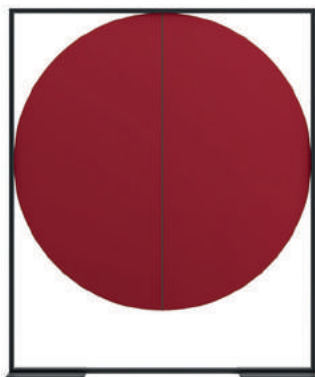

Freestanding module made up of  
a round panel upholstered in one  
color fabric on a matt black metal  
base.

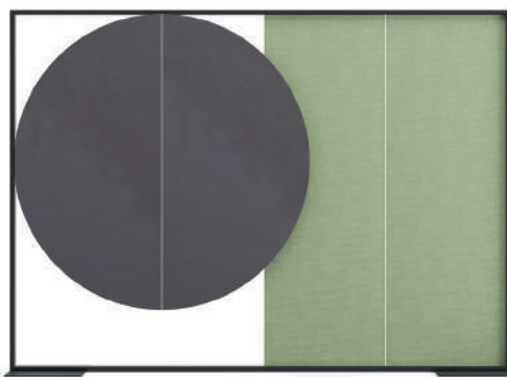

Freestanding module made up of a round and a square  
panel upholstered in one color fabric, with the choice of  
a different color for one panel, and resting on a matt black  
metal base.



Freestanding module made up of a square panel  
upholstered in one color fabric on a matt black metal base.

# Parentesit Wall Panel

The primary forms of Parentesit can be arranged to articulate graphic patterns adaptable to any environment.

The positions of the panels can further be assembled into different orientation options that extend the geometric visual language into compositions of parallel, perpendicular, or diagonal lines. All orientations of Parentesit can be determined in the installation process and, with only few tools required, can mount onto any wall surface. Minimal in form, minimal in effort.

The central aesthetic profile is available in the following colours:

- V12 (White Matt)
- V39 (Black Matt)

Warranty: 2 years

The Parentesit Wall Panel is available with three options for embedded functionality.

- 1 Sound Absorbing:  
an acoustic panel version is made from certified sound absorbing materials for when quiet space is needed.
- 2 Light:  
a switch-operated, built-in light-enabled version enhances visual impact.
- 3 Audio + Light:  
light-and-audio-enabled version with dimmer switch is manageable via dedicated app.dedicata (downloadable from App Store and Google Play).

## Composition examples

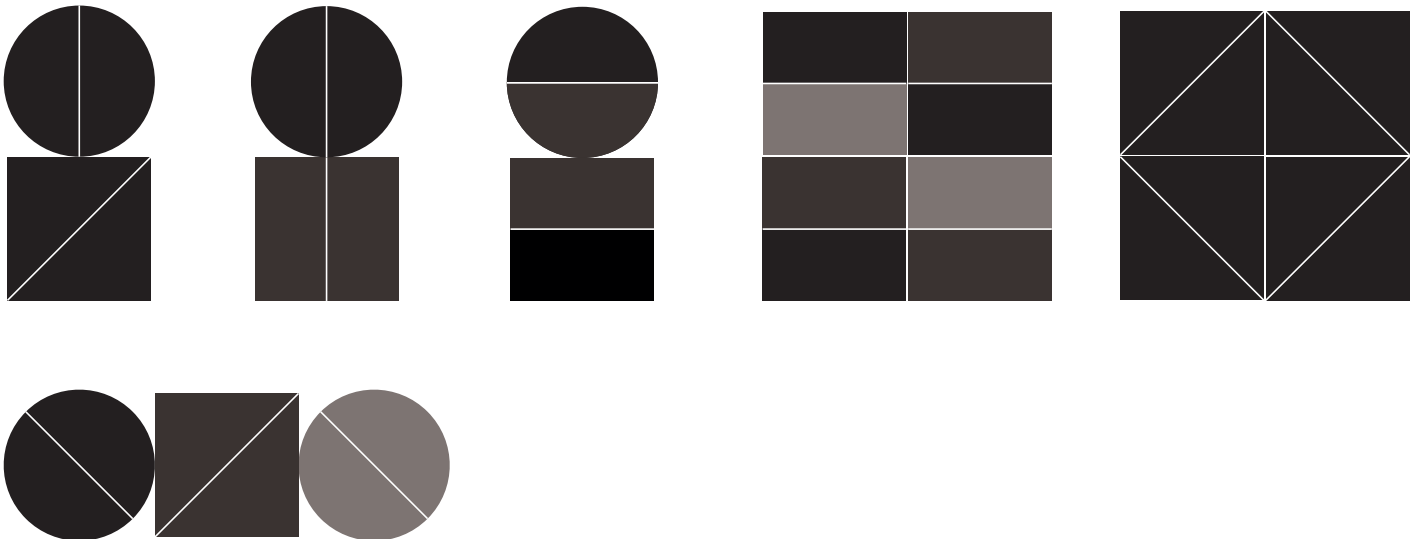



# Parentesit Wall Panel

The sound absorbing Parentesit Wall Panel is made from an internal panel that has been tested and certified for its superior performance in absorbing ambient sound. In the testing process, to maximize the effectiveness of the sound absorbing Parentesit Wall Panel, upholstery options are available in fabrics that help to muffle sound, giving additional protection against environmental noise and increased opportunity for quiet, uninterrupted work.

1 The internal panel was tested in a controlled echo chamber according to the UNI EN ISO 354 standard. The results shown here indicate absorption coefficients for every frequency tested, demonstrating the efficacy of Parentesit to reduce noise under a broad range of frequencies.

2 According to the industry standard used to classify sound absorbing material, ISO 11654, the values of sound absorbing coefficients are expressed by  $\alpha$ . This table shows the sound absorbing curves classified in classes from A to E, where A is the best.

Note: The sound absorbing characteristics are lost if it is upholstered with non breathable materials.

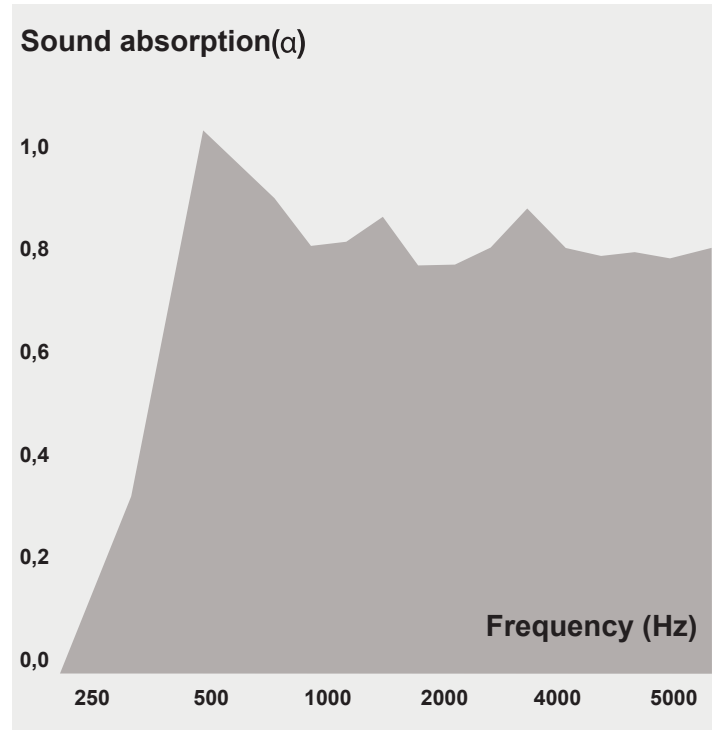

Example diagram

1

2

<b>Sound absorption (<math>\alpha</math>)</b>  <b>0,90</b>	<b>Sound absorption (<math>\alpha</math>)</b>  <b>0,85</b>	<b>Sound absorption (<math>\alpha</math>)</b>  <b>0,75</b>
<b>Fabrics:</b>  Jet Hallingdal 65 Tonus 4	<b>Fabrics:</b>  Field 2 Revive 1 Remix 2	<b>Fabrics:</b>  Canvas 2 Divina 3 Divina MD Divina Melange 2 Steelcut 2 Steelcut Trio 3
<b>Absorption Class</b>  <b>A</b>	<b>Absorption Class</b>  <b>B</b>	<b>Absorption Class</b>  <b>C</b>

# Parentesit Freestanding

A private enclosure for collaborative work contexts. Freestanding Parentesit creates a retreat for individual, focused work or collaborative group discussions. Four versions — inset little circle, big circle, square, or circle and square combination — are each given structure and substance by a supportive frame. These modular pieces can be combined to create graphic expressions of archetypal forms or customized with color to generate bold compositions that articulate space and define shelter.

## Composition examples

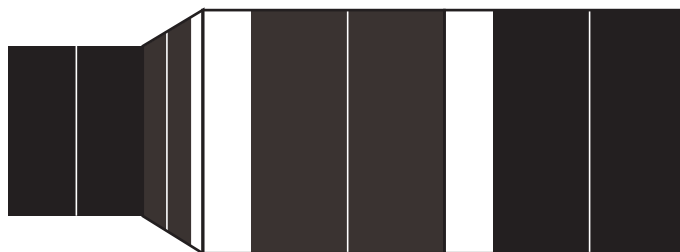
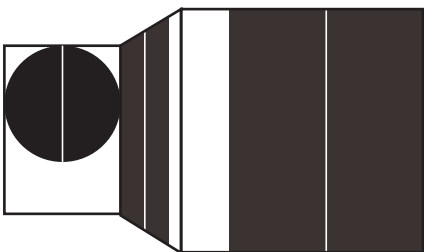
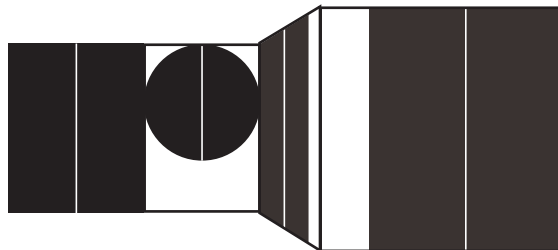
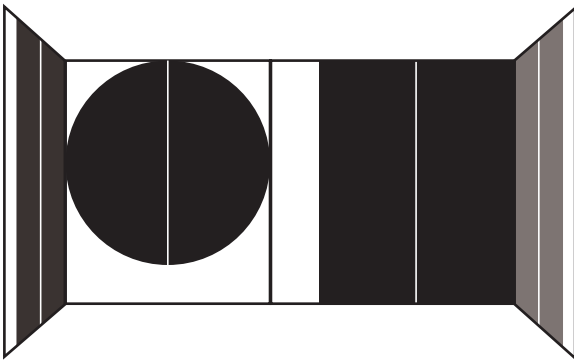
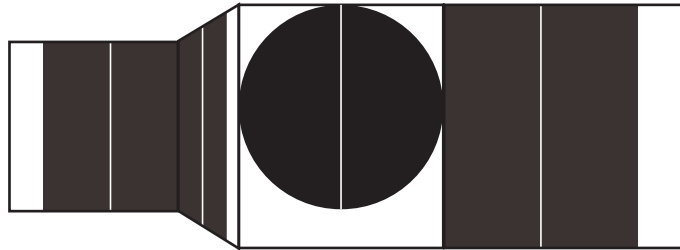

# Parentesit Freestanding

## Correct usage of plates and links

SINGLE MODULE

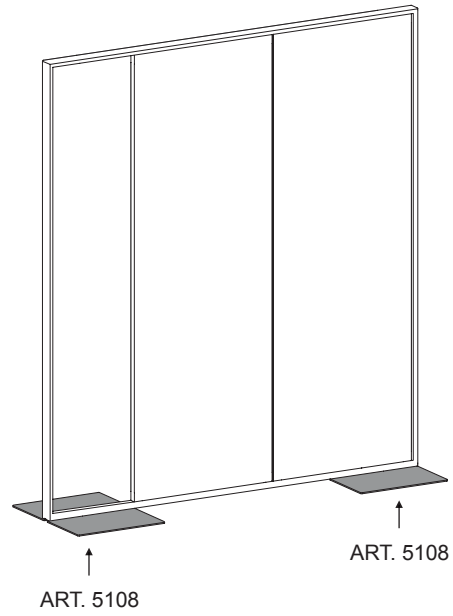

LINEAR MODULES

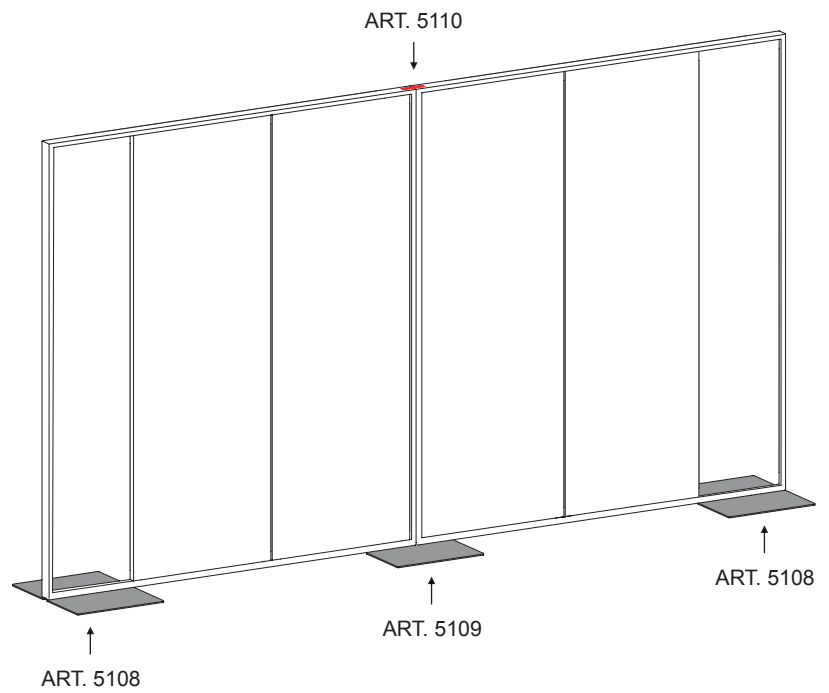

# Parentesit Freestanding

"L" MODULES

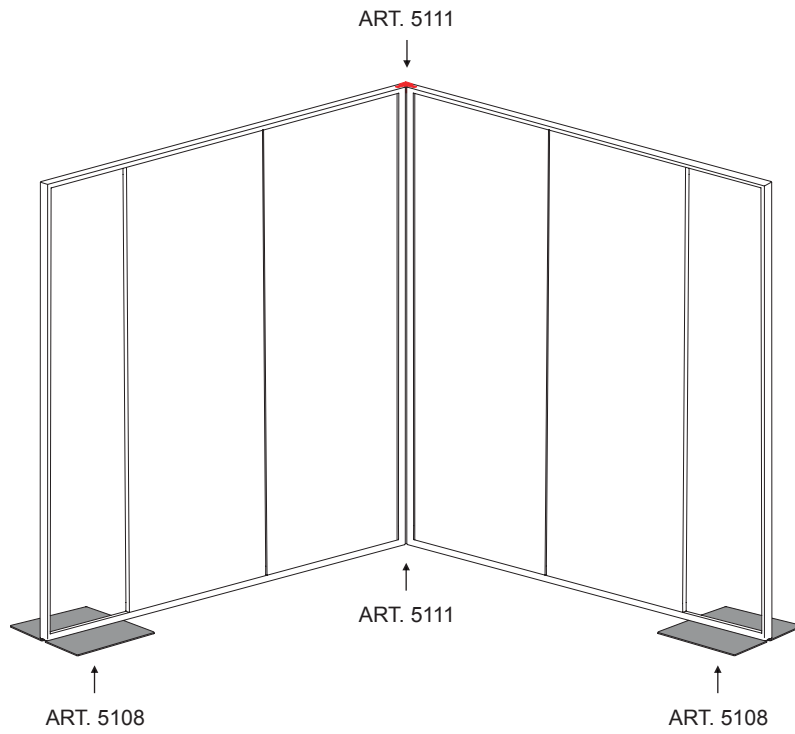

"T" MODULES

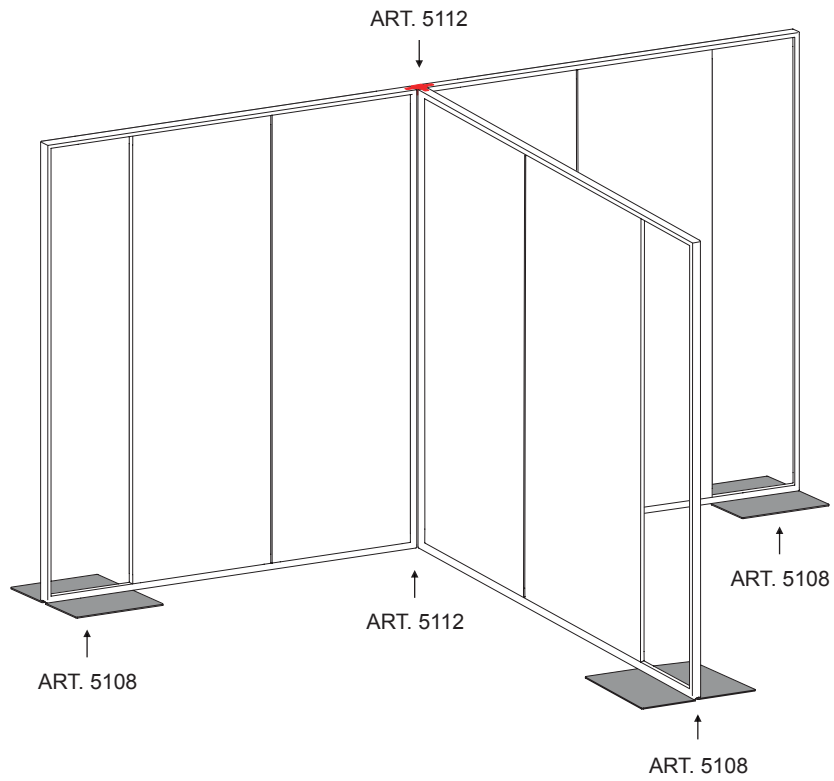

# Parentesit Freestanding

“+” MODULES

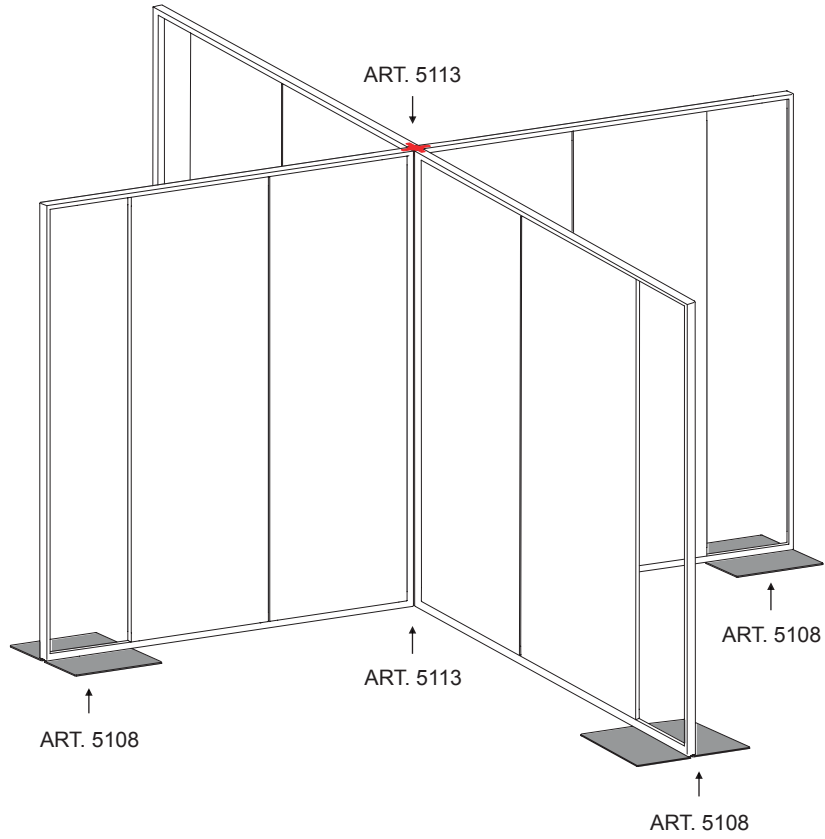

# Parentesit Wall Panel

Design by Lievore Altherr Molina, 2015

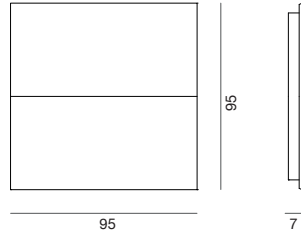

Decorative modular wall panel that is sound-absorbent and can be accessorised with a light, or audio + light system. Dimensions: 95 x 95 cm, available in one colour or two colours version, with horizontal insert (white or black). Electric cable not included.

SEK ART. 5100	A	B COM	C	D	E	F	G	H	I	J	K	L	M
Upholstered with a single material in one color	9132	9620	10108	10596	11084	11572	12060	12548	13036	13524	14012	14500	14988
Upholstered with a single material in two colors	+ 107	+ 178	+ 249	+ 320	+ 391	+ 462	+ 533	+ 604	+ 675	+ 746	+ 817	+ 888	+ 959
Optional LED light + speaker	+ 8002												
Optional LED light	+ 3739												

SHIPMENT DETAILS	TECHNICAL SPECIFICATIONS	RESISTANCE TEST
<b>Art. 5100</b> 1 pz = 1  - kg 14/ m³ 0,205 1 pz = 1  - kg 16,5/ m³ 0,205 1 pz = 1  - kg 16,8/ m³ 0,205 1 pz = 1  - kg 17,5/ m³ 0,205	<b>Art.5100</b> H 140 cm, COM Meterage m 1.38 Acoustic performance: Sound absorption coefficient "A" pursuant to the ISO 11654 standard = equivalent sound absorption area for sound-absorbing packet in m2 * Contact the company for specific data = Sound Absorption Area per each type of panel  Electrical/Audio/Lighting system: CE-marked product. The product has undergone very strict tests and obtained the most important European and international certifications.	
<b>FIRE RETARDANT TEST</b>		



# Parentesit Wall Panel

Design by Lievore Altherr Molina, 2015

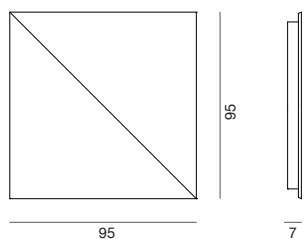

Decorative modular wall panel that is sound-absorbent and can be accessorised with a light, or audio + light system. Dimensions: 95 x 95 cm, available in one color or two colors version, with diagonal insert (white or black). Electric cable not included.

SEK ART. 5101	A	B COM	C	D	E	F	G	H	I	J	K	L	M
Upholstered with a single material in one color	9121	9550	9979	10408	10837	11266	11695	12124	12553	12982	13411	13840	14269
Upholstered with a single material in two colors	+ 595	+ 1012	+ 1429	+ 1846	+ 2263	+ 2680	+ 3097	+ 3514	+ 3931	+ 4348	+ 4765	+ 5182	+ 5599
Optional LED light + speaker	+ 8002												
Optional LED light	+ 3739												

SHIPMENT DETAILS	TECHNICAL SPECIFICATIONS	RESISTANCE TEST
<b>Art. 5101</b> 1 pz = 1  - kg 14,5/ m³ 0,205 1 pz = 1  - kg 17/ m³ 0,205 1 pz = 1  - kg 17,3/ m³ 0,205 1 pz = 1  - kg 18/ m³ 0,205	<b>Art.5101</b> H 140 cm. COM Meterage m 1.23 Acoustic performance: Sound absorption coefficient "A" pursuant to the ISO 11654 standard = equivalent sound absorption area for sound-absorbing packet in m2 * Contact the company for specific data = Sound Absorption Area per each type of panel  Electrical/Audio/Lighting system: CE-marked product. The product has undergone very strict tests and obtained the most important European and international certifications.	
<b>FIRE RETARDANT TEST</b>		



# Parentesit Wall Panel

Design by Lievore Altherr Molina, 2015

Decorative modular wall panel that is sound-absorbent and can be accessorised with a light, or audio + light system. Dimensions: Ø 100 cm, available in one color or two colors version, with central insert (white or black). Electric cable not included.

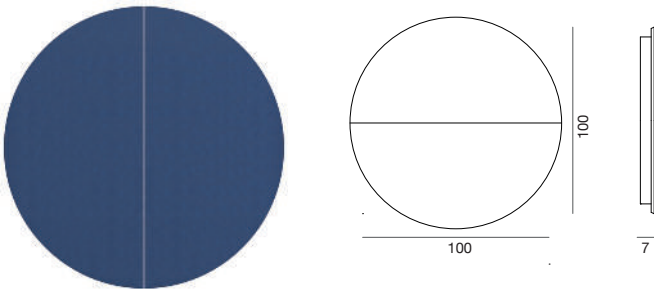

SEK ART. 5102	A	B COM	C	D	E	F	G	H	I	J	K	L	M
Upholstered with a single material in one color	9300	9812	10324	10836	11348	11860	12372	12884	13396	13908	14420	14932	15444
Upholstered with a single material in two colors	+ 36	+ 131	+ 226	+ 321	+ 416	+ 511	+ 606	+ 701	+ 796	+ 891	+ 986	+ 1081	+ 1176
Optional LED light + speaker	+ 7502												
Optional LED light	+ 3239												

SHIPMENT DETAILS	TECHNICAL SPECIFICATIONS	RESISTANCE TEST
<b>Art. 5102</b> 1 pz = 1  - kg 13/ m² 0,205 1 pz = 1  - kg 15,5/ m² 0,205 1 pz = 1  - kg 15,8/ m² 0,205 1 pz = 1  - kg 16,8/ m² 0,205	<b>Art.5102</b> H 140 cm, COM Meterage m 1.35 Acoustic performance: Sound absorption coefficient "A" pursuant to the ISO 11654 standard = equivalent sound absorption area for sound-absorbing packet in m2 * Contact the company for specific data = Sound Absorption Area per each type of panel  Electrical/Audio/Lighting system: CE-marked product. The product has undergone very strict tests and obtained the most important European and international certifications.	
<b>FIRE RETARDANT TEST</b>		





# Parentesit

Design by Lievore Altherr Molina, 2016

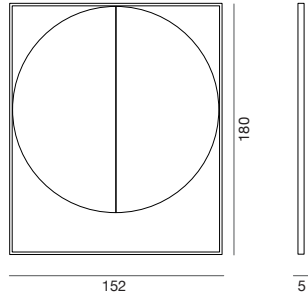
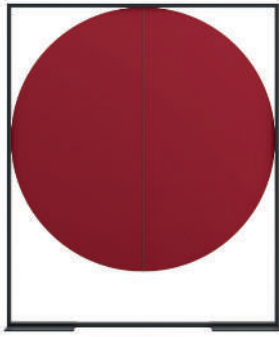

Freestanding module made up of a round panel upholstered in one color fabric on a matt black metal base. The internal decorative panel as sound absorption features, it is also available in two color upholstery with a surcharge. Fixing plate and connection kit are supplied separately for the creation of modular compositions.

**Accessories:**

Standard single plate Art. 5108  
Link kit for "T" modules Art. 5112

Plate single junction Art. 5109  
Link kit for "+" modules Art. 5113

Link kit for linear modules Art. 5110    Link kit for "L" modules Art. 5111

SEK ART. 5105	A	B	COM	C	D	E	F	G	H	I	J	K	L	M
Upholstered with a single material in just one color	23040	24493	25946	27399	28852	30305	31758	33211	34664	36117	37570	39023	40476	
Upholstered with a single material in two colors: surcharge	+ 476	+ 786	+ 1096	+ 1406	+ 1716	+ 2026	+ 2336	+ 2646	+ 2956	+ 3266	+ 3576	+ 3886	+ 4196	
Set of glides for single pannel	+ 2370													

SHIPMENT DETAILS	TECHNICAL SPECIFICATIONS	RESISTANCE TEST
<b>Art. 5105</b> 1 pz = 3  - kg 39,7/ m³ 0,177 1 pz = 4  - kg 58,7/ m³ 0,184 	<b>Art.5105</b> H 140 cm. COM Meterage m 9.81	
<b>FIRE RETARDANT TEST</b>		

Frame Base



# Parentesit

Design by Lievore Altherr Molina, 2016

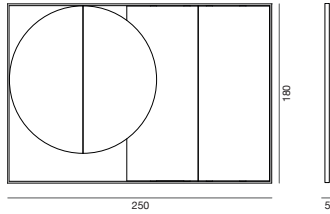
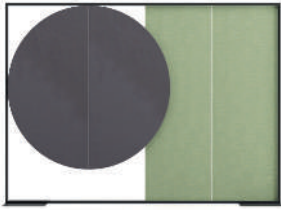

Freestanding module made up of a round and a square panel upholstered in one color fabric, with the choice of a different color for one panel, and resting on a matt black metal base. The internal decorative panels have sound absorption features. Fixing plate and connection kit are supplied separately for the creation of modular compositions.

**Accessories:**

Standard single plate Art. 5108  
Link kit for "T" modules Art. 5112

Plate single junction Art. 5109  
Link kit for "+" modules Art. 5113

Link kit for linear modules Art. 5110    Link kit for "L" modules Art. 5111

SEK ART. 5106	A	B COM	C	D	E	F	G	H	I	J	K	L	M
Upholstered with a single material in one/two colors	39675	42509	45343	48177	51011	53845	56679	59513	62347	65181	68015	70849	73683
Set of glides for single pannel	+ 2370												

SHIPMENT DETAILS	TECHNICAL SPECIFICATIONS	RESISTANCE TEST
<b>Art. 5106</b> 1 pz = 3  - kg 59/ m² 0,35 1 pz = 4  - kg 88/ m² 0,199 	<b>Art.5106</b> H 140 cm. COM Meterage m 8.62	
<b>FIRE RETARDANT TEST</b>		

Frame Base



V39  
matt









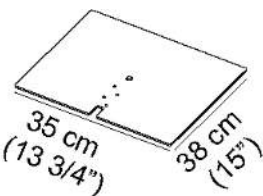
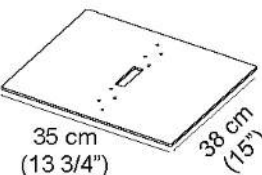
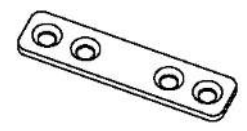
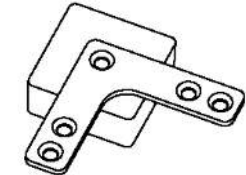
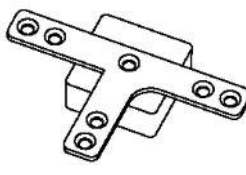
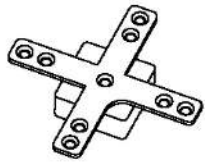

# Accessories

Design by Lievore Altherr Molina, 2016

<p><b>SEK ART. 5108</b></p>  <p>35 cm (13 3/4") 38 cm (15")</p> <p>Standard single plate</p> <p>1191</p>	<p><b>SEK ART. 5109</b></p>  <p>35 cm (13 3/4") 38 cm (15")</p> <p>Plate single junction</p> <p>1191</p>	<p><b>SEK ART. 5110</b></p>  <p>Link kit for linear modules</p> <p>666</p>	<p><b>SEK ART. 5111</b></p>  <p>Link kit for "L" modules</p> <p>666</p>	<p><b>SEK ART. 5112</b></p>  <p>Link kit for "T" modules</p> <p>666</p>
<p><b>SEK ART. 5113</b></p>  <p>Link kit for "+" modules</p> <p>666</p>				

SHIPMENT DETAILS		TECHNICAL SPECIFICATIONS	
<b>Art. 5108</b>	1 pz = 1  - kg 9/ m³ 0,07	<b>Art. 5109</b>	1 pz = 1  - kg 9/ m³ 0,07
<b>Art. 5110</b>	1 pz = 1  - kg 1/ m³ 0,004	<b>Art. 5111</b>	1 pz = 1  - kg 1/ m³ 0,004
<b>Art. 5112</b>	1 pz = 1  - kg 1/ m³ 0,004	<b>Art. 5113</b>	1 pz = 1  - kg 1/ m³ 0,004
<b>FIRE RETARDANT TEST</b>			





# FINISHES

**Aava 02**

Polipropilene  
Polypropylene  
Polypropylen  
Polypropylène  
Polipropileno



**Adell**

Polipropilene  
Polypropylene  
Polypropylen  
Polypropylène  
Polipropileno



**Babar**

Stelo ABS  
Stem ABS  
Stern ABS  
Carénage colonne ABS  
Soporte ABS



**Babar**

Cuscino in poliuretano  
Cushion in polyurethane  
Kissen in Polyurethan  
Coussin en polyuréthane  
Cojín en poliuretano



**Catifa 46**

Polipropilene monocolor  
Polypropylene one colour  
Polypropylen einfarbig  
Polypropylène monocolor  
Polipropileno monocolor

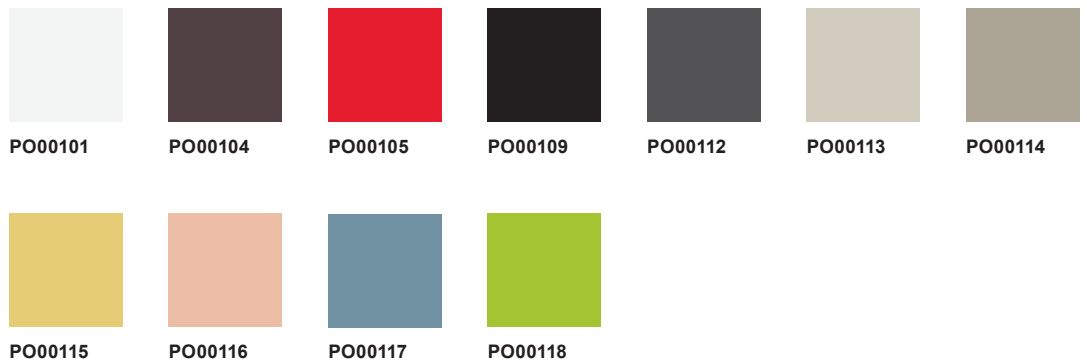

**Catifa 46**

Polipropilene bicolore  
Polypropylene two colors  
Polypropylen zweifarbig  
Polypropylène bicolore  
Polipropileno bicolor



Catifa 53

Polipropilene monocolor  
Polypropylene one colour  
Polypropylen einfarbig  
Polypropylène monocolor  
Polipropileno monocolor

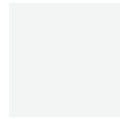

PO00401



PO00404



PO00409



PO00412



PO00413



PO00415



PO00419



PO00420

Cila & Cila Go

Polipropilene  
Polypropylene  
Polypropylen  
Polypropylène  
Polipropileno

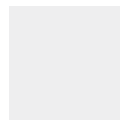

PC00001



PC00002



PC00003



PC00004



PC00005\*

\*non disponibile per base sgabello  
\*not available for the stool base  
\*nicht verfügbar für Hockergestell  
\*non disponible pour piètement tabouret  
\*no disponible para base de taburete

Duna 02

Polipropilene  
Polypropylene  
Polypropylen  
Polypropylène  
Polipropileno

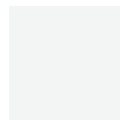

PP0001



PP0004



PP0005



PP0006

Juno 02

Polipropilene  
Polypropylene  
Polypropylen  
Polypropylène  
Polipropileno

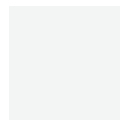

PT00011



PT00012



PT00013



PT00014



PT00015



PT00016

Kinesit

Polipropilene  
Polypropylene  
Polypropylen  
Polypropylène  
Polipropileno

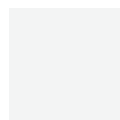

PA00001



PA00002

Leaf

Cuscino in poliuretano  
Cushion in polyurethane  
Kissen in Polyurethan  
Coussin en polyuréthan  
Cojín en poliuretano

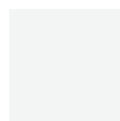

PU00001



PU00007



PU00008



**Mixu**

Polipropilene  
Polypropylene  
Polypropylen  
Polypropylène  
Polipropileno

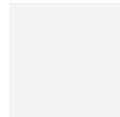

PM00001



PM00002



PM00003



PM00004



PM00005

**Ralik**

Polipropilene  
Polypropylene  
Polypropylen  
Polypropylène  
Polipropileno

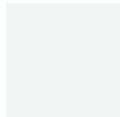

P68



P25



P63



P65



P67

**Shaal**

Polipropilene  
Polypropylene  
Polypropylen  
Polypropylène  
Polipropileno



P25

**Stacy**

Polipropilene  
Polypropylene  
Polypropylen  
Polypropylène  
Polipropileno

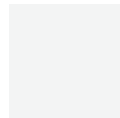

PS00001



PS00002



PS00003



PS00004



PS00005

Metalli  
Metals  
Metalle  
Métal  
Metal



CRO LU1 S03 V12 - matt / glossy V24 - matt V25 - matt



V39 - matt V44 - matt V54 - matt V68 - matt

Arcos

Metalli  
Metals  
Metalle  
Métal  
Metal



V39 - matt V59 - matt V60 - matt V61 - matt V62 - matt

Adell

Metalli  
Metals  
Metalle  
Métal  
Metal



V44 - matt V53 - matt V64 - matt

Catifa 46

Metalli  
Metals  
Metalle  
Métal  
Metal



CRO LU1 S03 V12 - matt V13 - matt V39 - matt



V48 - matt V53 - matt V54 - matt V55 - matt V56 - matt V57 - matt

Dizzie

Metalli  
Metals  
Metalle  
Métal  
Metal



V12 - glossy V34 - glossy V39 - glossy V39 - matt V48 - glossy V53 - glossy

Kinesit Met

Metalli  
Metals  
Metalle  
Métal  
Metal



V14 - matt V15 - matt V16 - matt

Leaf

Metalli  
Metals  
Metalle  
Métal  
Metal

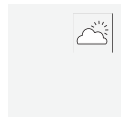

V12 - matt



V13 - matt



V34 - matt

Mixu

Metalli  
Metals  
Metalle  
Métal  
Metal

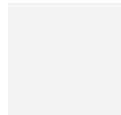

CRO



V25 - matt



V63 - matt



V65 - matt



V66 - matt

Oell

Metalli  
Metals  
Metalle  
Métal  
Metal



V44 matt

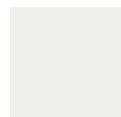

V12 matt



V53 matt



V63 matt

Onemm

Metalli  
Metals  
Metalle  
Métal  
Metal

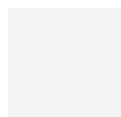

V24 matt



V25 matt



V61 - matt

Pix table

Metalli  
Metals  
Metalle  
Métal  
Metal

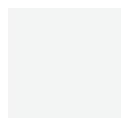

V12 - matt



V39 - matt

Ralik

Metalli  
Metals  
Metalle  
Métal  
Metal



V25



V63



V65



V67

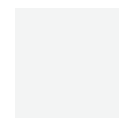

V68

Stacy

Metalli  
Metals  
Metalle  
Métal  
Metal



CRO

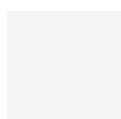

V12 - matt



V25 - matt



V57 - matt



V63 - matt

Dizzie Art. 0681

Top in MDF + laminato bianco  
Top on MDF + laminate white  
Tischplatte aus MDF + laminat weiß  
Plateau en MDF + laminé blanc  
Sobre de MDF + laminado blanco

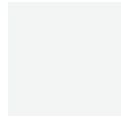

M02 - glossy



M34 - glossy



M39 - glossy



M48 - glossy



M53 - glossy

Dizzie

Marmo  
Marble  
Marmor  
Marbre  
Mármol



B01

Fenix®  
fenixntm.com

Laminati  
Laminate  
Laminat  
Laminé  
Laminado

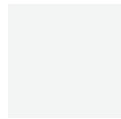

F01 - Fenix



F02 - Fenix



F06 - Fenix

Ghia

MDF



M08



M09

Ghia

Terrazzo  
Venetian Terrazzo  
Venezianische Terrazzo  
Terrazzo vénitien  
Terrazo



B10

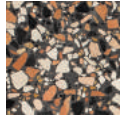

B11

Leaf

Compact HPL

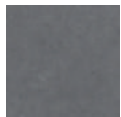

H04

Wim / Yop

Compact HPL

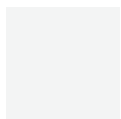

H02



H03

Wim / Yop

Nobilitato  
Melamine  
Melamin  
Mélaminé  
Melamínico

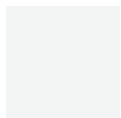

N01



N02

Oell  
Gres Porcellanato  
Porcelain Stoneware  
Feinsteinzeug  
Grès cérame  
Gres porcelánico

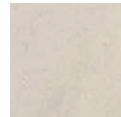

C10



C11

Oell  
MDF

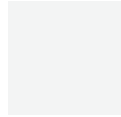

M02



M20

Pix table  
MDF

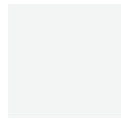

M02



M04

Roopa  
MDF



M75



M76



M77



M78

Roopa  
Vetro  
Glass  
Glas  
Verre  
Vidrio



V75



V76



V77



V78

Saul  
Vetro  
Glass  
Glas  
Verre  
Vidrio



V02

Semiton  
MDF

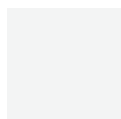

M24



M25



M18



M19



M21



M30



M38



M69



M70



M71



M72



M67



M73



M74

Legno  
Wood  
Holz  
Bois  
Madera



L0020



L0021



L0022



L0023

Aava 02

Legno  
Wood  
Holz  
Bois  
Madera

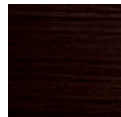

L0006



L0022

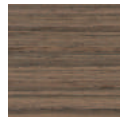

L0028

Adell

Legno  
Wood  
Holz  
Bois  
Madera



L0006



L0022

Cross

Legno  
Wood  
Holz  
Bois  
Madera



L21



L22

Dizzie  
Art. 0680  
Art. 0900



L0006



L0022

Family

Legno  
Wood  
Holz  
Bois  
Madera



L14



L15



L21

Kata

Legno  
Wood  
Holz  
Bois  
Madera



L0006



L0022



L0023

Mixu

Legno  
Wood  
Holz  
Bois  
Madera



L0006



L0022

Ply

Legno  
Wood  
Holz  
Bois  
Madera



L0006



L0022

Saya

Legno  
Wood  
Holz  
Bois  
Madera



L0001



L0006



L0022



L0023

Semiton

Legno  
Wood  
Holz  
Bois  
Madera



L0006



L0022



L0027



L0028

Steeve

Legno  
Wood  
Holz  
Bois  
Madera



L0006



L0022



L0028

Wing

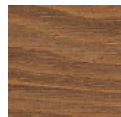

L14

Zinta

Legno  
Wood  
Holz  
Bois  
Madera



L0006



L0022



L0023

Kiik

Laminati  
Laminate  
Laminat  
Laminé  
Laminado

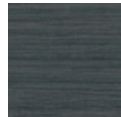

LM13

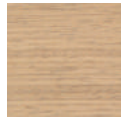

LM00022

Zinta

Laminati  
Laminate  
Laminat  
Laminé  
Laminado



LM00022

**Kata**

Tessuto 3D Knit microimbottito con pattern grafico

3D Knit with graphic pattern

Mikrowattierter 3D-Knit-Stoff mit grafischem Muster

Tissu 3D Knit micro-rembourré avec motif graphique

Tejido 3D Knit microacolchado con patrón gráfico

グラフィックパターンのマイクロパッド入り3Dニットファブリック



LINEN - 3E00001



WHEAT - 3E00002



CHARCOAL - 3E00003

**Kata**

Tessuto 3D Knit con pattern a righe

3D Knit with striped pattern

3D-Knit-Stoff mit Streifenmuster

Tissu 3D Knit avec motif à rayures

Tejido 3D Knit con patrón de rayas

ストライプパターンの3Dニットファブリック



WATER - 3B00001



WHEAT - 3B00002



CHARCOAL - 3B00003





CHROME FREE

ELMOSOFT è una pelle semi-anilina, morbida e flessibile. La sua morbidezza associata alla sua robustezza e ad una vasta gamma di colori disponibili rendono la pelle Elmosoft adatta ad un utilizzo nel contract. Punture di insetti e cicatrici visibili contribuiscono a valorizzare le caratteristiche di unicità ed eleganza di questa pelle.

ELMOSOFT is a soft and pliable Semi-Aniline leather. Outstanding comfort combined with excellent durability and an extensive shade card, makes it very suitable for the public environment. Visible insect-bites and scars from healed wounds add to the elegant quality of the leather.

ELMOSOFT. Weiches, geschmeidiges Semi-Anilinleder, Ein sehr strapazierfähiges und im Griff komfortables Leder in reicher Farbauswahl, hervorragend geeignet für Objektausstattungen. Sichtbar erhaltene Insektenstiche und kleine vernarbte Wunden betonen die naturechte Eleganz.

ELMOSOFT est un cuir semi-aniline, souple et doux. Son confort élevé, associé à une grande robustesse et à vste gamme de coloris disponibles, le rend particulièrement indiqué pour les collectivités. Les piqûres d'insectes et les cicatrices visibles contribuent à rehausser le caractère élégant du cuir.

ELMOSOFT es una piel semianilina suave y flexible. Su destacable confort combinado con excelente durabilidad y una amplia gama de colores, la hacen muy adecuada para ambientes públicos. Picaduras de insectos visibles y cicatrices de heridas contribuyen a valorar la elegante calidad de la piel.

Arper grade  
CHAIRS: ES  
SOFAS: ES



ES00100



ES00109



ES00118



ES01003



ES01021



ES01037



ES01043



ES01061



ES01085



ES02119



ES02122



ES05011



ES05029

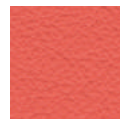

ES05145



ES07006



ES08021



ES08038

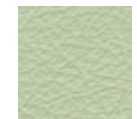

ES08055



ES08057



ES08124



ES11033



ES11049

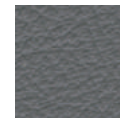

ES11056



ES11073

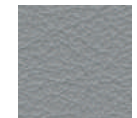

ES11152



ES13048



ES13072



ES13087



ES16003



ES16377



ES17027



ES22024



ES22030



ES33001



ES33004



ES33077



ES35126



ES43054



ES43283



ES44012



ES45035



ES45065



ES46053



ES54021



ES54033



ES54035



ES55002

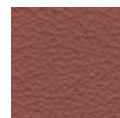

ES66006



ES71017



ES75010



ES75011



ES75014



ES77074



ELMOSOFT è una pelle semi-anilina, morbida e flessibile. La sua morbidezza associata alla sua robustezza e ad una vasta gamma di colori disponibili rendono la pelle Elmosoft adatta ad un utilizzo nel contract. Punture di insetti e cicatrici visibili contribuiscono a valorizzare le caratteristiche di unicità ed eleganza di questa pelle.

ELMOSOFT is a soft and pliable Semi-Aniline leather. Outstanding comfort combined with excellent durability and an extensive shade card, makes it very suitable for the public environment. Visible insect-bites and scars from healed wounds add to the elegant quality of the leather.

ELMOSOFT. Weiches, geschmeidiges Semi-Anilinleder, Ein sehr strapazierfähiges und im Griff komfortables Leder in reicher Farbauswahl, hervorragend geeignet für Objektausstattungen. Sichtbar erhaltene Insektenstiche und kleine vernarbte Wunden betonen die naturechte Eleganz.

ELMOSOFT est un cuir semi-aniline, souple et doux. Son confort élevé, associé à une grande robustesse et à une vaste gamme de coloris disponibles, le rend particulièrement indiqué pour les collectivités. Les piqûres d'insectes et les cicatrices visibles contribuent à rehausser le caractère élégant du cuir.

ELMOSOFT es una piel semianilina suave y flexible. Su destacable confort combinado con excelente durabilidad y una amplia gama de colores, la hacen muy adecuada para ambientes públicos. Picaduras de insectos visibles y cicatrices de heridas contribuyen a valorar la elegante calidad de la piel.

Arper grade  
CHAIRS: ES  
SOFAS: ES



ES77127



ES77158



ES77237



ES78023



ES87021



ES88019



ES91102

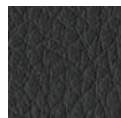

ES93068

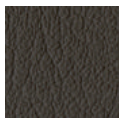

ES93099

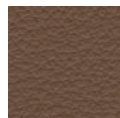

ES93109



ES93129



ES95006



ES97038



ES98015



ES98047

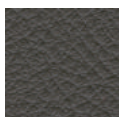

ES98087

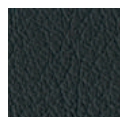

ES99999



NEOCOAST

Soft leather  
Weichleder  
Cuir souple  
Piel

Arper grade  
CHAIRS: H  
SOFAS: H

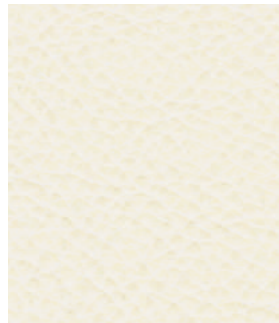

P400114



P402061



P412097



P418008



P443041



P443084

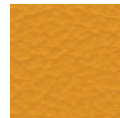

P444015

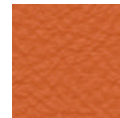

P445024

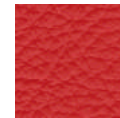

P455058

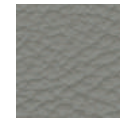

P471010

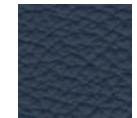

P477022



P477035



P488017

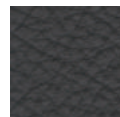

P491097

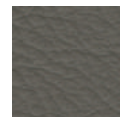

P491100

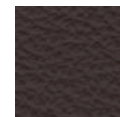

P493090

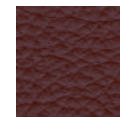

P495042



P498016

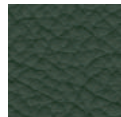

P498043

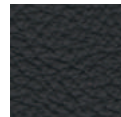

P499076

Pelle Fiore  
Soft leather  
Weichleder  
Cuir souple  
Piel

Arper grade  
CHAIRS: I  
SOFAS: I

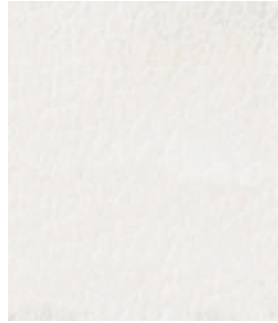

PF00001

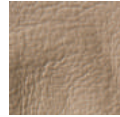

PF00003



PF00004



PF00007



PF00014

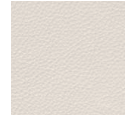

PF00015



PF00016

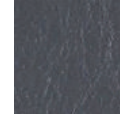

PF00017



PF00018



PF00019



PF00020

Cuoio  
Hard leather  
Kernleder  
Cuir  
Cuero

Arper grade  
CHAIRS: CT  
SOFAS: CT

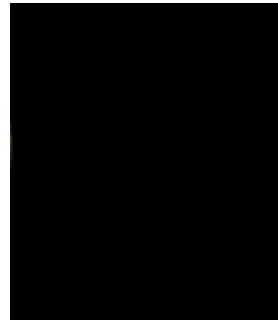

CT00020

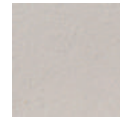

CT00031



CT00033



CT00034



CT00090

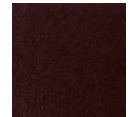

CT00120

Only for Catifa 46, Catifa 53 e Norma collections

Cuciture a contrasto standard  
Standard contrast stitching  
Standard Kontrastnähte  
Surpiqûre standard à contrast  
Costura contraste estándar



CT00120  
Cucitura in ocre  
Ochre stitching  
Ockergelbe Nähte  
Surpiqûre en Ocre  
Costura ocre

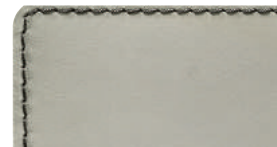

CT00031  
Cucitura in grigio scuro  
Dark grey stitching  
Dunkelgraue Nähte  
Surpiqûre en gris foncé  
Costura gris obscuro



**SPRADLING®**

Valencia

Tessuto spalmato Valencia  
Coated fabric Valencia  
Beschichtete textilien Valencia  
Tissus enduits Valencia  
Tejido recubierto Valencia

Arper grade  
CHAIRS: **B**  
SOFAS: **B**



VL02020



VL00001



VL00002



VL00020

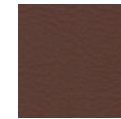

VL00033



VL00034



VL00035



VL01001



VL01048



VL01049



VL01050



VL02001



VL02002



VL02021



VL02062



VL02074



VL02075



VL02106



VL02107



VL02108



VL02109



VL02110



VL02111



VL02112



VL02113

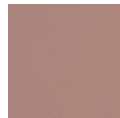

VL02114



VL02115



VL02116



VL02117



VL02118



VL02119



VL03001



VL03067



VL03068



VL03069



VL04001



VL04002

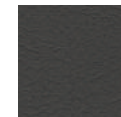

VL04003



VL04040



VL04041



VL04042



VL04043



VL04044



VL04045

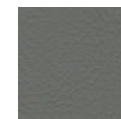

VL04052



VL05001

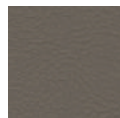

VL05002



VL05041



VL05056



VL05057

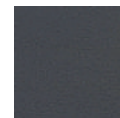

VL05065



VL05069



VL06002





**SPRADLING®**

Valencia

Tessuto spalmato Valencia  
Coated fabric Valencia  
Beschichtete textilien Valencia  
Tissus enduits Valencia  
Tejido recubierto Valencia

Arper grade  
CHAIRS: **B**  
SOFAS: **B**



VL06003



VL06012



VL06013



VL06019



VL07001



VL08032



VL09001



VL09035



VL09607



VL090C02





**SPRADLING®**  
Silvertex

Arper grade  
CHAIRS: **C**  
SOFAS: **B**



SX00001	SX01010	SX01014	SX01051	SX01077	SX01078	
SX02003	SX02011	SX02012	SX02016	SX02064	SX02089	SX02090
SX02091	SX02092	SX02093	SX02094	SX02095	SX02096	SX02097
SX02098	SX02099	SX02100	SX02101	SX02102	SX02103	SX02104
SX02105	SX03001	SX03007	SX03066	SX03067	SX03068	SX04001
SX04002	SX04003	SX04004	SX04010	SX04011	SX04012	SX04024
SX05008	SX05009	SX05010	SX05019	SX05020	SX05063	SX06004
SX06061	SX06062	SX06065	SX07001	SX07002	SX09001	SX09002

# kvadrat

Atom

Arper grade  
CHAIRS: **Atom**



AM00124



AM00194

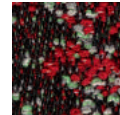

AM00574

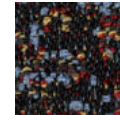

AM00774

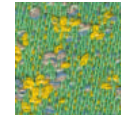

AM00944

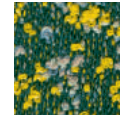

AM00964

Available only for Adell collection.

# kvadrat

Balder 3

Arper grade  
CHAIRS: |  
SOFAS: |  
PANELS: |



B100132

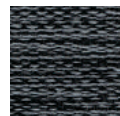

B100152

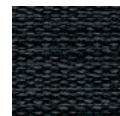

B100192

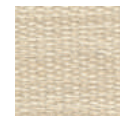

B100212

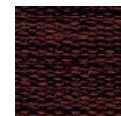

B100382



B100432

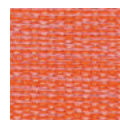

B100542

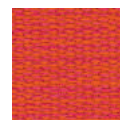

B100562



B100612

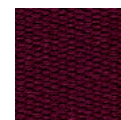

B100682



B100692

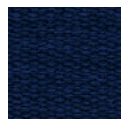

B100782

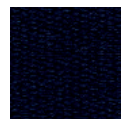

B100792

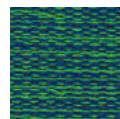

B100862

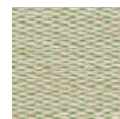

B100912

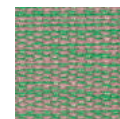

B100942

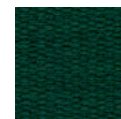

B100982

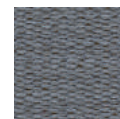

B101775

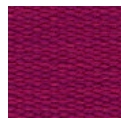

B102635



# kvadrat

Canvas 2



Kvadrat's Canvas 2 has been awarded the EU Ecolabel

Arper grade  
CHAIRS: D  
SOFAS: F  
PANELS: D



# kvadrat

Divina 3



Kvadrat's Divina 3 has been awarded the EU Ecolabel

Arper grade  
CHAIRS: G  
SOFAS: I  
PANELS: G



DV00171



DV00106



DV00154



DV00173



DV00181

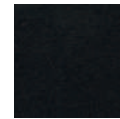

DV00191



DV00224



DV00236



DV00246



DV00334



DV00346



DV00356



DV00376



DV00384



DV00393



DV00426



DV00444



DV00462



DV00526



DV00536



DV00542



DV00552



DV00562



DV00584



DV00623



DV00626



DV00636



DV00652

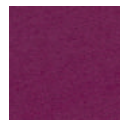

DV00662

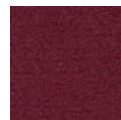

DV00671



DV00666

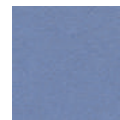

DV00676



DV00684



DV00686



DV00691



DV00692



DV00696



DV00712



DV00742



DV00756



DV00782



DV00791



DV00793



DV00826



DV00836



DV00846



DV00856



DV00876



DV00886



DV00893



DV00922



DV00936

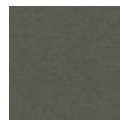

DV00944



DV00956



DV00966

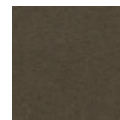

DV00984

# kvadrat

Divina MD



Kvadrat's Divina MD has been awarded the EU Ecolabel

Arper grade  
CHAIRS: G  
SOFAS: I  
PANELS: G



DI00193



DI00203



DI00213



DI00293



DI00343



DI00353



DI00363



DI00413



DI00433



DI00453

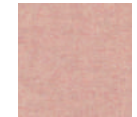

DI00613



DI00633



DI00653

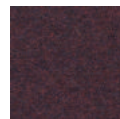

DI00673

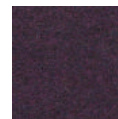

DI00683



DI00713



DI00733



DI00743

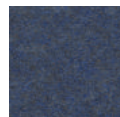

DI00753



DI00773

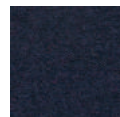

DI00783



DI00813



DI00843



DI00873



DI00913



DI00943



DI00973

# kvadrat

Divina Melange 3



Kvadrat's Divina Melange 3 has been awarded the EU Ecolabel

Arper grade  
CHAIRS: G  
SOFAS: I  
PANELS: G



DM00120



DM00147



DM00170



DM00180



DM00227



DM00237



DM00260



DM00277



DM00280



DM00367



DM00427



DM00457



DM00467



DM00471



DM00517



DM00527



DM00547



DM00557



DM00567



DM00571

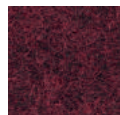

DM00581

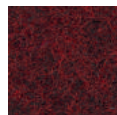

DM00597

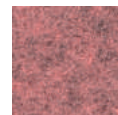

DM00617



DM00620



DM00647



DM00677



DM00687



DM00731



DM00747



DM00757



DM00777



DM00787



DM00821



DM00871



DM00917



DM00937



DM00967



DM00977



# kvadrat

Field 2



Kvadrat's Field 2 has been awarded the EU Ecolabel

Arper grade  
CHAIRS: B  
SOFAS: C  
PANELS: B



FI00123

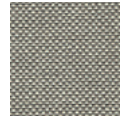

FI00132

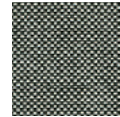

FI00142

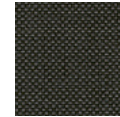

FI00173

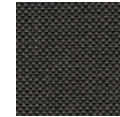

FI00182



FI00192



FI00222



FI00233

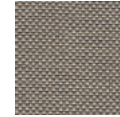

FI00242

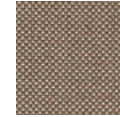

FI00343

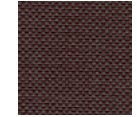

FI00373

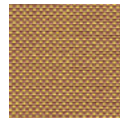

FI00443

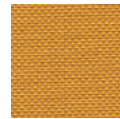

FI00463

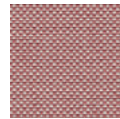

FI00623

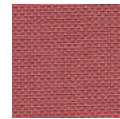

FI00643



FI00662

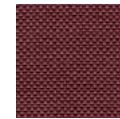

FI00663



FI00673



FI00693

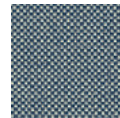

FI00723



FI00733



FI00763



FI00773



FI00782

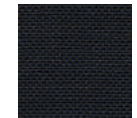

FI00793

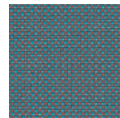

FI00843



FI00933



FI00943



FI00963

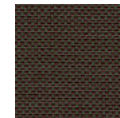

FI00983

# kvadrat

Fiord 2 (EU Ecolabel)



Kvadrat's Fiord 2 has been awarded the EU Ecolabel

Arper grade  
CHAIRS: F  
SOFAS: F  
PANELS: F



FD00101



FD00121

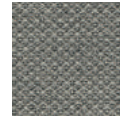

FD00151

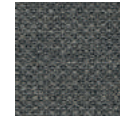

FD00171



FD00191

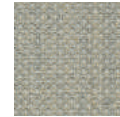

FD00201

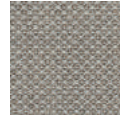

FD00251

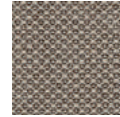

FD00262

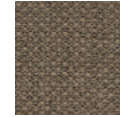

FD00271



FD00322



FD00351

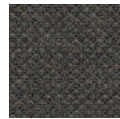

FD00371



FD00382

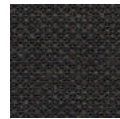

FD00391

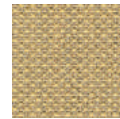

FD00422

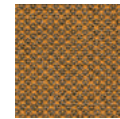

FD00442

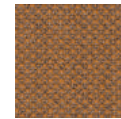

FD00451

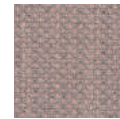

FD00521



FD00551

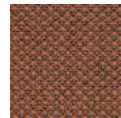

FD00562

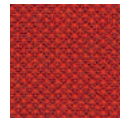

FD00571

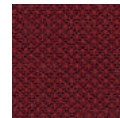

FD00581



FD00591



FD00642



FD00662

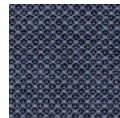

FD00672

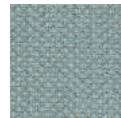

FD00721

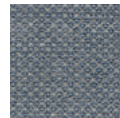

FD00751

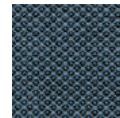

FD00762

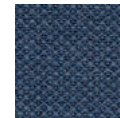

FD00771

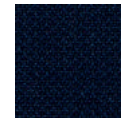

FD00782

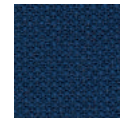

FD00791

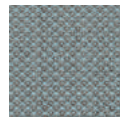

FD00821

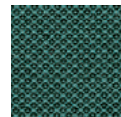

FD00862



FD00951

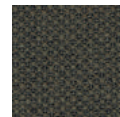

FD00961



FD00971

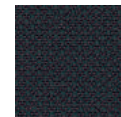

FD00981



FD00991

# kvadrat

Floyd

Arper grade  
CHAIRS: C  
SOFAS: C  
PANELS: C



F100103



F100123



F100143

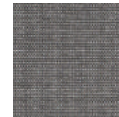

F100163



F100193



F100213



F100223



F100243



F100263

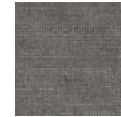

F100363



F100413

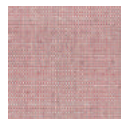

F100623



F100643



F100663



F100693



F100723

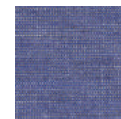

F100763



F100783



F100793



F100923



F100943



F100963



F100983



# kvadrat

Hallingdal 65 (EU Ecolabel)



Kvadrat's Hallingdal 65 has been awarded the EU Ecolabel

Arper grade  
 CHAIRS: G  
 SOFAS: G  
 PANELS: G(\*)



HA00103



HA00100

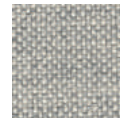

HA00110



HA00113

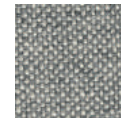

HA00116

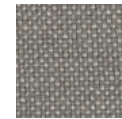

HA00123

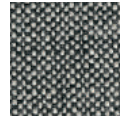

HA00126

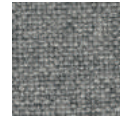

HA00130

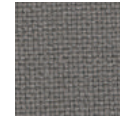

HA00143

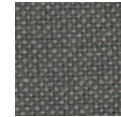

HA00153

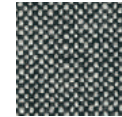

HA00166

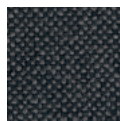

HA00173



HA00180



HA00190



HA00200



HA00220



HA00224

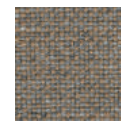

HA00227

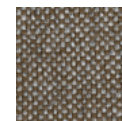

HA00270



HA00350

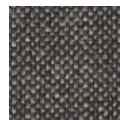

HA00368



HA00370

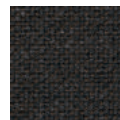

HA00376



HA00390

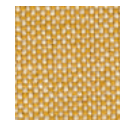

HA00407

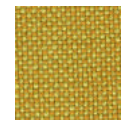

HA00420



HA00457

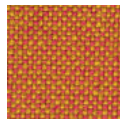

HA00526

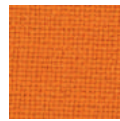

HA00547



HA00563



HA00573

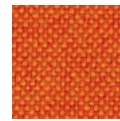

HA00590

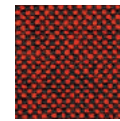

HA00596

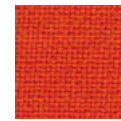

HA00600

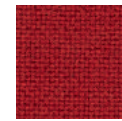

HA00657



HA00660



HA00674



HA00680

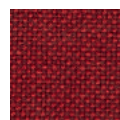

HA00687



HA00694



HA00702



HA00723

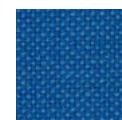

HA00733



HA00750

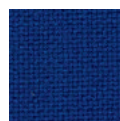

HA00753

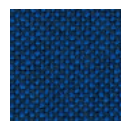

HA00754

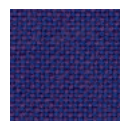

HA00763



HA00764



HA00773

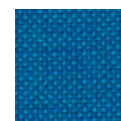

HA00810

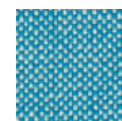

HA00840

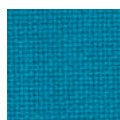

HA00850

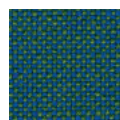

HA00890



HA00907



HA00944



HA00960

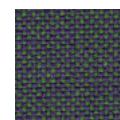

HA00968

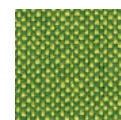

HA00980

Not available for Paravan collection



# kvadrat

Jaali



Kvadrat's Jaali has been awarded the EU Ecolabel

Arper grade  
CHAIRS: **G**  
SOFAS: **G**  
PANELS: **G**

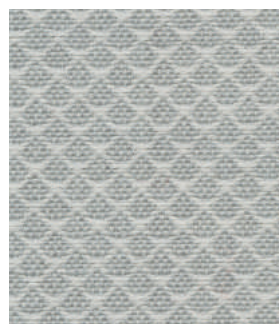

JA00101

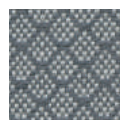

JA00121

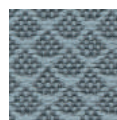

JA00141

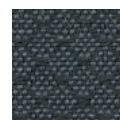

JA00171



JA00201



JA00341

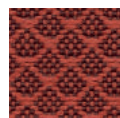

JA00561

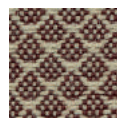

JA00571



JA00591



JA00611

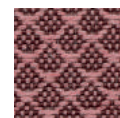

JA00651

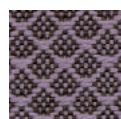

JA00671

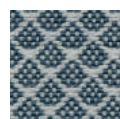

JA00751



JA00761

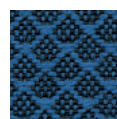

JA00781

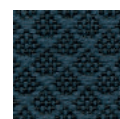

JA00791

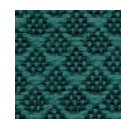

JA00871



JA00951



JA00961



JA00991

# kvadrat

Patio

Arper grade  
CHAIRS: D  
SOFAS: D



(\*) Not available for Pix Outdoor collection.

# kvadrat

Re-wool



Kvadrat's Re-wool has been awarded the EU Ecolabel

Arper grade  
CHAIRS: E  
SOFAS: E  
PANELS: E

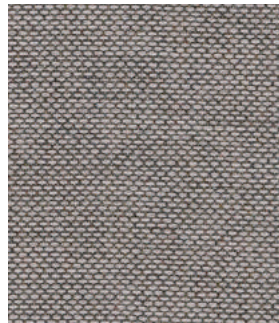

RW00108

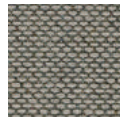

RW00128



RW00158

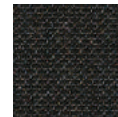

RW00198



RW00218



RW00358



RW00378

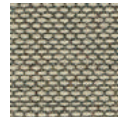

RW00408

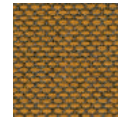

RW00448



RW00458



RW00558

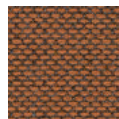

RW00568

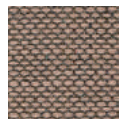

RW00628

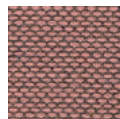

RW00648

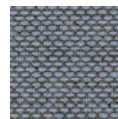

RW00658

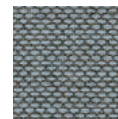

RW00718

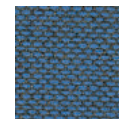

RW00758

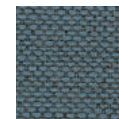

RW00768

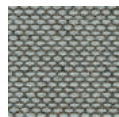

RW00828

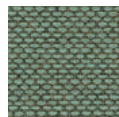

RW00858

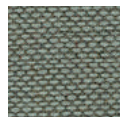

RW00868



# kvadrat

Remix 3 (EU Ecolabel)



Kvadrat's Remix 3 has been awarded the EU Ecolabel

Arper grade  
CHAIRS: C  
SOFAS: D  
PANELS: C

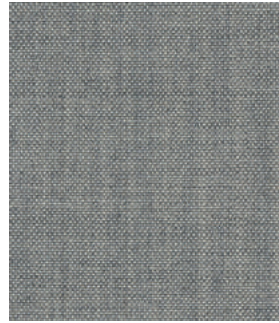

RX00123



RX00113 (\*)

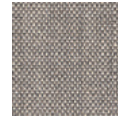

RX00126

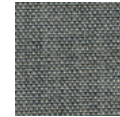

RX00133

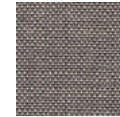

RX00136

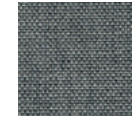

RX00143

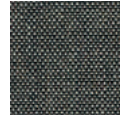

RX00152

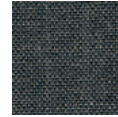

RX00163

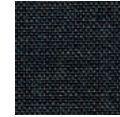

RX00173

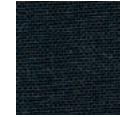

RX00183

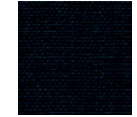

RX00196



RX00223 (\*)

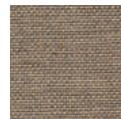

RX00233

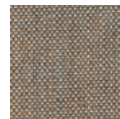

RX00242



RX00252

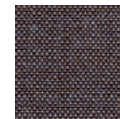

RX00266

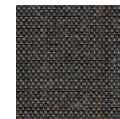

RX00276



RX00286

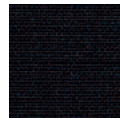

RX00296

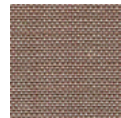

RX00326



RX00346

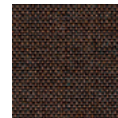

RX00356



RX00362



RX00373



RX00383

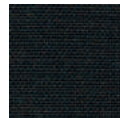

RX00393



RX00406



RX00412



RX00422



RX00433



RX00443

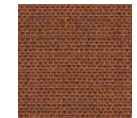

RX00452



RX00516



RX00536

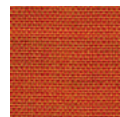

RX00543

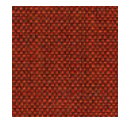

RX00566

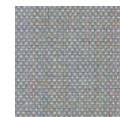

RX00606



RX00612



RX00632



RX00643

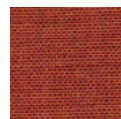

RX00653



RX00662



RX00672

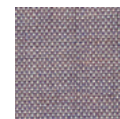

RX00682



RX00686

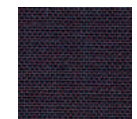

RX00692



RX00716

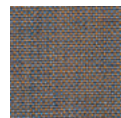

RX00722



RX00733

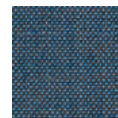

RX00743



RX00753

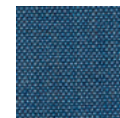

RX00762

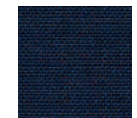

RX00773



# kvadrat

Remix 3 (EU Ecolabel)



Kvadrat's Remix 3  
has been awarded  
the EU Ecolabel

Arper grade  
CHAIRS: C  
SOFAS: D  
PANELS: C

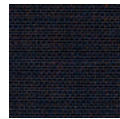

RX00783



RX00796

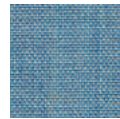

RX00816



RX00836

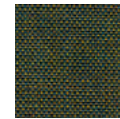

RX00842

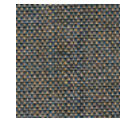

RX00852



RX00866

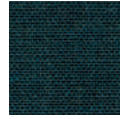

RX00873

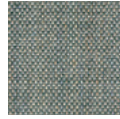

RX00906

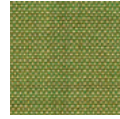

RX00912



RX00923

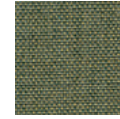

RX00933

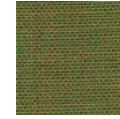

RX00942

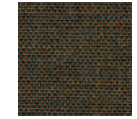

RX00954

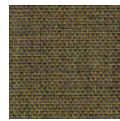

RX00962



RX00973

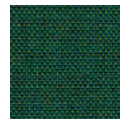

RX00982



RX00996

(\*) RX00113 - RX00223: only for the cushions Owl, Lines, Pleats e Gego.

# kvadrat

Revive 1

Arper grade  
CHAIRS: **B**  
SOFAS: **B**  
PANELS: **B**

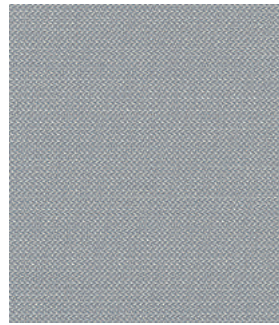

R100144

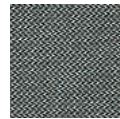

R100154

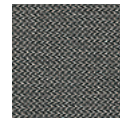

R100164



R100184



R100194

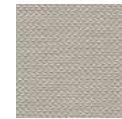

R100224

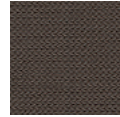

R100274

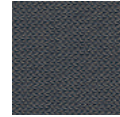

R100284

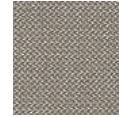

R100324



R100384

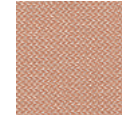

R100414



R100424



R100434

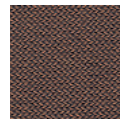

R100454



R100524



R100534



R100634



R100664



R100754

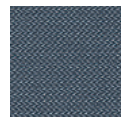

R100764



R100774



R100834

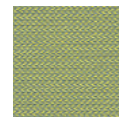

R100914

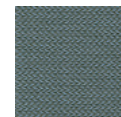

R100944



R100974

**kvadrat**  
Ria

Arper grade  
CHAIRS: **Ria**

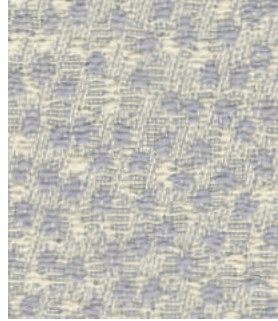

RA00111

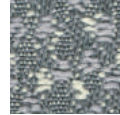

RA00141

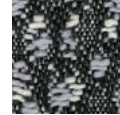

RA00181

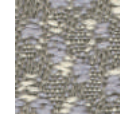

RA00241



RA00281

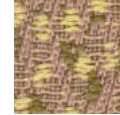

RA00431

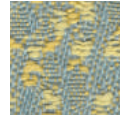

RA00441

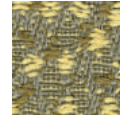

RA00451

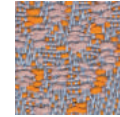

RA00541

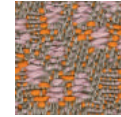

RA00551

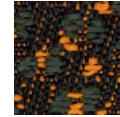

RA00591

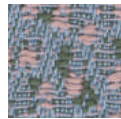

RA00741

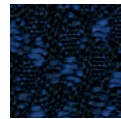

RA00791

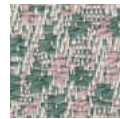

RA00921

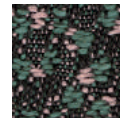

RA00981

Available only for Aston Club collection.



# kvadrat

Sonar 3

Arper grade  
CHAIRS: **Sonar**



S700113

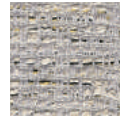

S700124

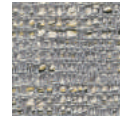

S700134

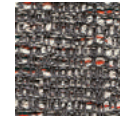

S700153

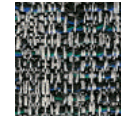

S700164

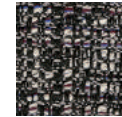

S700173



S700194

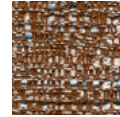

S700374

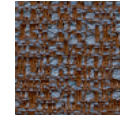

S700384

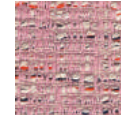

S700633

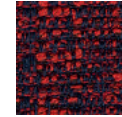

S700673

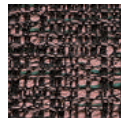

S700684

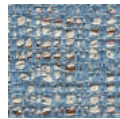

S700734

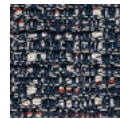

S700773

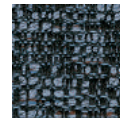

S700784

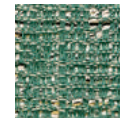

S700934

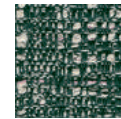

S700974

Available only for Aston Club collection.



# kvadrat

Steelcut 3



Kvadrat's Steelcut 3 has been awarded the EU Ecolabel

Arper grade  
CHAIRS: G  
SOFAS: H  
PANELS: G

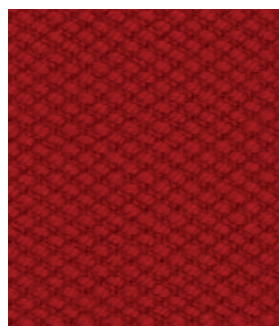

SE00545

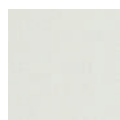

SE00110



SE00120



SE00140

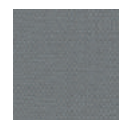

SE00155

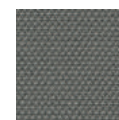

SE00160



SE00180

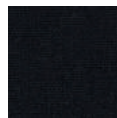

SE00190



SE00220



SE00240



SE00252



SE00265



SE00365



SE00402



SE00445



SE00452



SE00502



SE00512



SE00522



SE00535



SE00552



SE00562



SE00605



SE00612



SE00655



SE00662



SE00672



SE00682



SE00695



SE00732



SE00742



SE00775

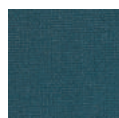

SE00780



SE00912



SE00922



SE00932



SE00962



SE00975

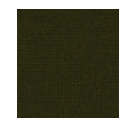

SE00985

# kvadrat

Steelcut Trio 3



Kvadrat's Steelcut Trio 3 has been awarded the EU Ecolabel

Arper grade  
CHAIRS: G  
SOFAS: H  
PANELS: G

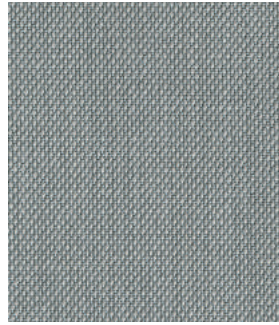

ST00113

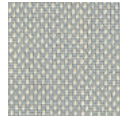

ST00105

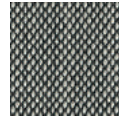

ST00124

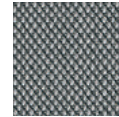

ST00133

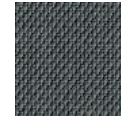

ST00153

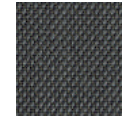

ST00176



ST00195

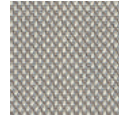

ST00205

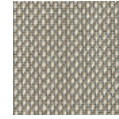

ST00213

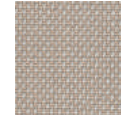

ST00226

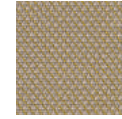

ST00236

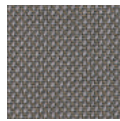

ST00246

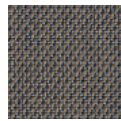

ST00253

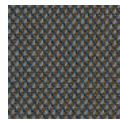

ST00266

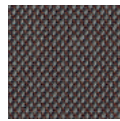

ST00276



ST00283

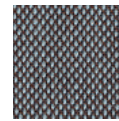

ST00336

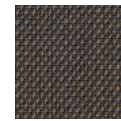

ST00376



ST00383

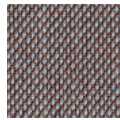

ST00416

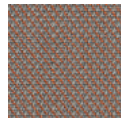

ST00426

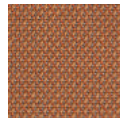

ST00436



ST00446

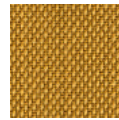

ST00453

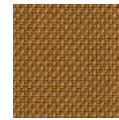

ST00466

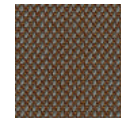

ST00476



ST00506

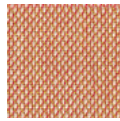

ST00515

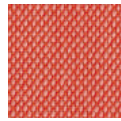

ST00526

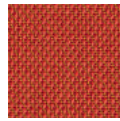

ST00533

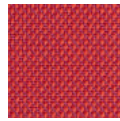

ST00553

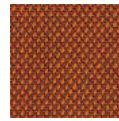

ST00576

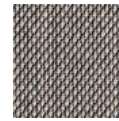

ST00616

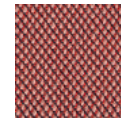

ST00636

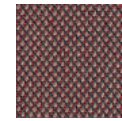

ST00645

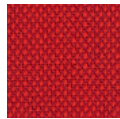

ST00666



ST00686

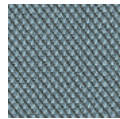

ST00713

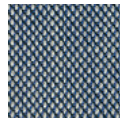

ST00716

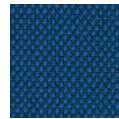

ST00746

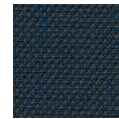

ST00756

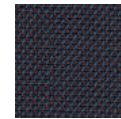

ST00776

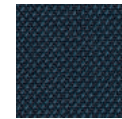

ST00796

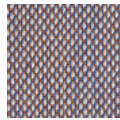

ST00806

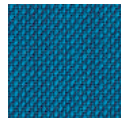

ST00865

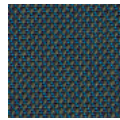

ST00883



ST00906

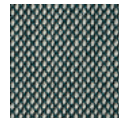

ST00916

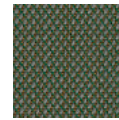

ST00946

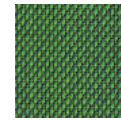

ST00953

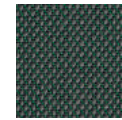

ST00966

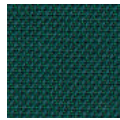

ST00976

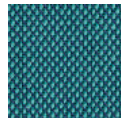

ST00983

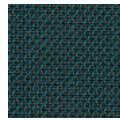

ST00996

# kvadrat

Tonus 4



Kvadrat's Tonus 4 has been awarded the EU Ecolabel

Arper grade  
CHAIRS: F  
SOFAS: G  
PANELS: F



T300100



T300118



T300125



T300128



T300129



T300130



T300131



T300132



T300135



T300207



T300210



T300216



T300224



T300240



T300244



T300364



T300374



T300394



T300424



T300440



T300454



T300464



T300474



T300508



T300554



T300605



T300608

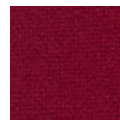

T300609



T300610



T300613

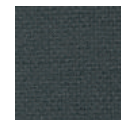

T300615



T300619



T300631



T300634



T300636



T300654



T300664



T300684



T300690



T300754



T300764



T300854



T300914



T300934



T300954



T300964



T300974



# kvadrat

Vidar 4



Kvadrat's Vidar 4 has been awarded the EU Ecolabel

Arper grade  
CHAIRS: J  
SOFAS: J  
PANELS: J



VD00106



VD00123



VD00133



VD00143

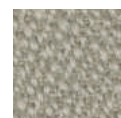

VD00146

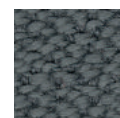

VD00152



VD00182



VD00222

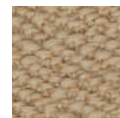

VD00323



VD00333



VD00353



VD00363



VD00386



VD00443



VD00456



VD00472

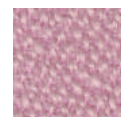

VD00526

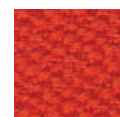

VD00542



VD00554

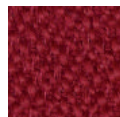

VD00556

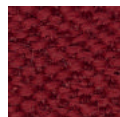

VD00582

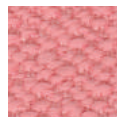

VD00622



VD00633

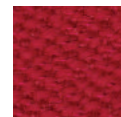

VD00653



VD00656



VD00676

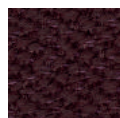

VD00693



VD00723



VD00733

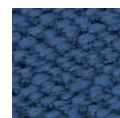

VD00743

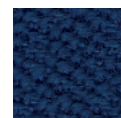

VD00772



VD00786



VD00872

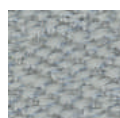

VD00913



VD00932



VD00943



VD00956



VD00972



VD01062



VD01511



VD01880



Jet

Arper grade  
 CHAIRS: A  
 SOFAS: A  
 PANELS: A



(\*) Not available for Cila and Cila Go collections





Jet

Arper grade  
CHAIRS: A  
SOFAS: A  
PANELS: A



JE09606



JE09607

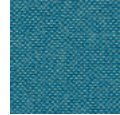

JE09608



JE09609



JE09610

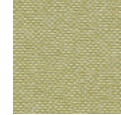

JE09701

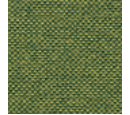

JE09702



JE09703



JE09704



JE09803



JE09804



JE09805



JE09806

(\*) Not available for Cila and Cila Go collections



**camira**  
Main Line Flax

Arper grade  
CHAIRS: C  
SOFAS: C  
PANELS: C



MFMLF01



MFMLF02

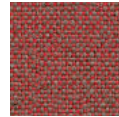

MFMLF03

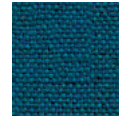

MFMLF05

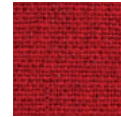

MFMLF06

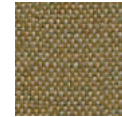

MFMLF07

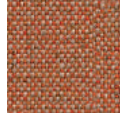

MFMLF08



MFMLF09



MFMLF10



MFMLF12

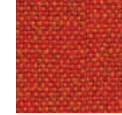

MFMLF13

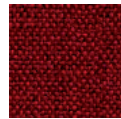

MFMLF14

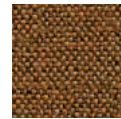

MFMLF15

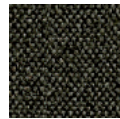

MFMLF16

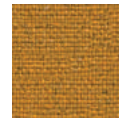

MFMLF17

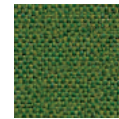

MFMLF18

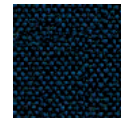

MFMLF19



MFMLF20



MFMLF21

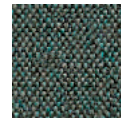

MFMLF22



MFMLF23

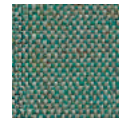

MFMLF24



MFMLF25



MFMLF26



MFMLF28

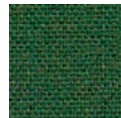

MFMLF29

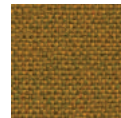

MFMLF31



MFMLF32

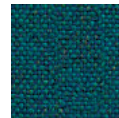

MFMLF34

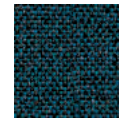

MFMLF35



MFMLF36



MFMLF37

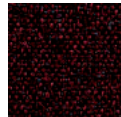

MFMLF40



MFMLF43

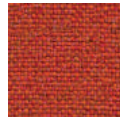

MFMLF44

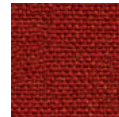

MFMLF45

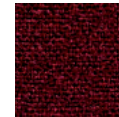

MFMLF46



MFMLF47



MFMLF48

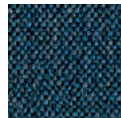

MFMLF49

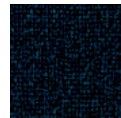

MFMLF50

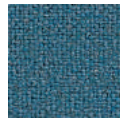

MFMLF51



MFMLF52

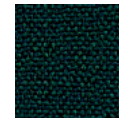

MFMLF53

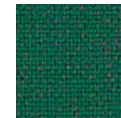

MFMLF54

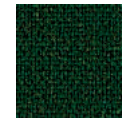

MFMLF55



MFMLF56



MFMLF57



MFMLF59



MFMLF60



MFMLF61



MFMLF62



MFMLF63

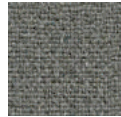

MFMLF64

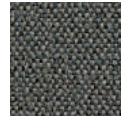

MFMLF65

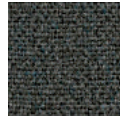

MFMLF66

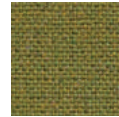

MFMLF67

**camira**  
Phoenix

Arper grade  
CHAIRS: A  
SOFAS: A  
PANELS: A



PHYP005



PHYP009



PHYP011

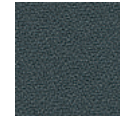

PHYP019

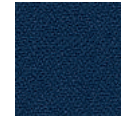

PHYP026



PHYP045

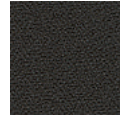

PHYP046

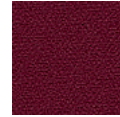

PHYP051



PHYP076

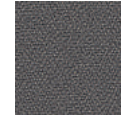

PHYP081

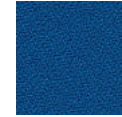

PHYP082



PHYP084



PHYP097

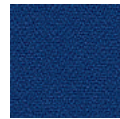

PHYP100



PHYP105



PHYP106



PHYP107

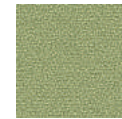

PHYP108



PHYP110

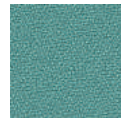

PHYP112



PHYP113



**camira**  
Synergy

Arper grade  
CHAIRS: C  
SOFAS: C  
PANELS: C



**camira**  
Synergy

Arper grade  
CHAIRS: C  
SOFAS: C  
PANELS: C



SNLDS67



SNLDS68



SNLDS69



SNLDS70



SNLDS71



SNLDS72



SNLDS73



SNLDS74



SNLDS75

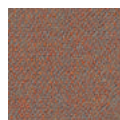

SNLDS76



SNLDS77



SNLDS78



SNLDS79



SNLDS80



SNLDS81



SNLDS82



SNLDS84



SNLDS85



SNLDS86



SNLDS87



SNLDS88

**camira**  
Urban

Arper grade  
CHAIRS: **B**  
SOFAS: **B**  
PANELS: **B**

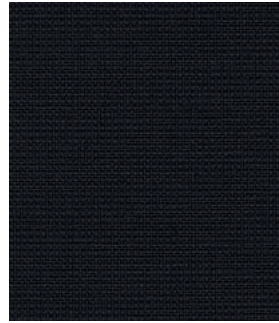

UPYN009

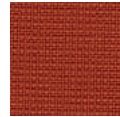

UPYN027

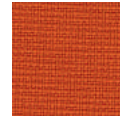

UPYN076

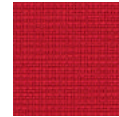

UPYN079

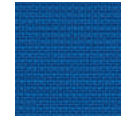

UPYN082

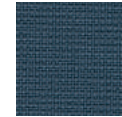

UPYN083

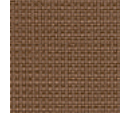

UPYN091



UPYN094

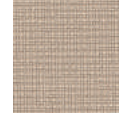

UPYN108

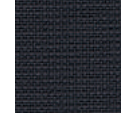

UPYN145



UPYN148



UPYN159

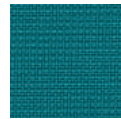

UPYN160

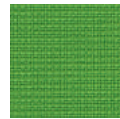

UPYN200

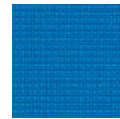

UPYN202

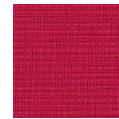

UPYN203

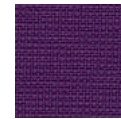

UPYN204

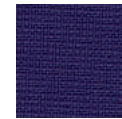

UPYN205

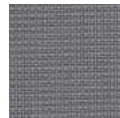

UPYN206

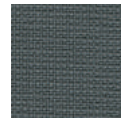

UPYN207

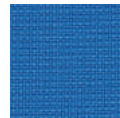

UPYN208

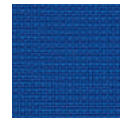

UPYN209



UPYN210



UPYN211



UPYN212

**Gabriel**  
Rhythm



PA00001  
(Gabriel 60000)

Only for Kinesit.



PA00002  
(Gabriel 60999)



**maharam**  
Messenger

Arper grade  
CHAIRS: D  
SOFAS: D  
PANELS: D

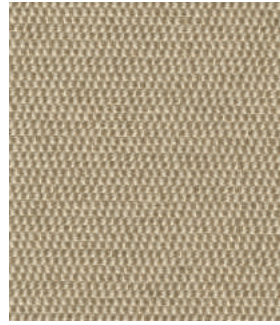

MS00001

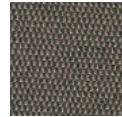

MS00007

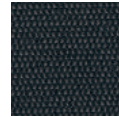

MS00008

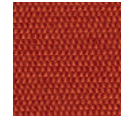

MS00024



MS00025



MS00029

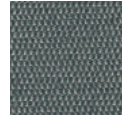

MS00031

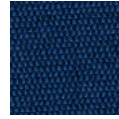

MS00038

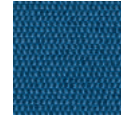

MS00040

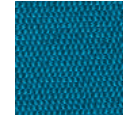

MS00041



MS00045

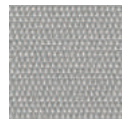

MS00046



MS00048

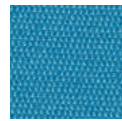

MS00050

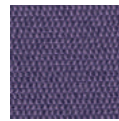

MS00051

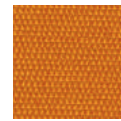

MS00053

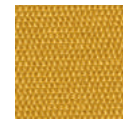

MS00054



MS00058

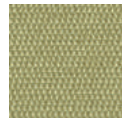

MS00060

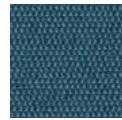

MS00061

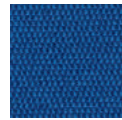

MS00062

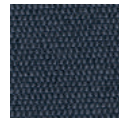

MS00063

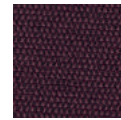

MS00066



MS00067

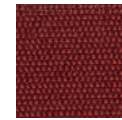

MS00069

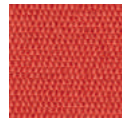

MS00070

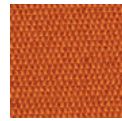

MS00071

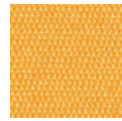

MS00072

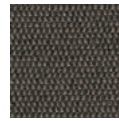

MS00076

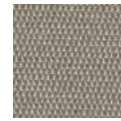

MS00077



MS00078

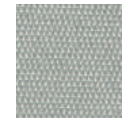

MS00079



MS00080



MS00081



MS00082

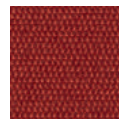

MS00083



MS00084

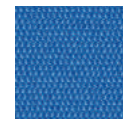

MS00085



MS00086



MS00087

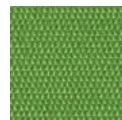

MS00088



MS00089



MS00090

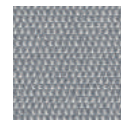

MS00091

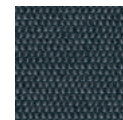

MS00092

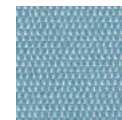

MS00093

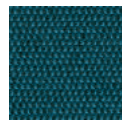

MS00094

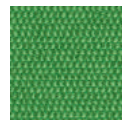

MS00095

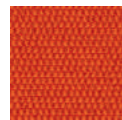

MS00096

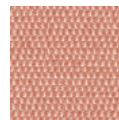

MS00097

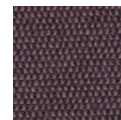

MS00098



Sera

Arper grade  
CHAIRS: Sera

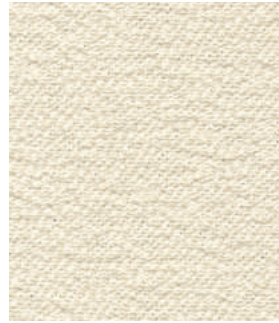

S800001

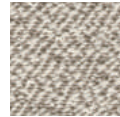

S800002

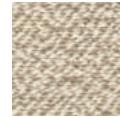

S800003

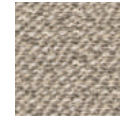

S800004

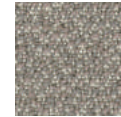

S800005

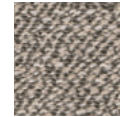

S800006

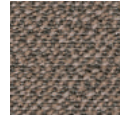

S800007

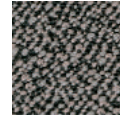

S800008

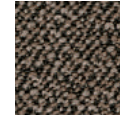

S800009



S800010

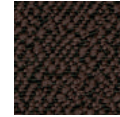

S800011



S800012

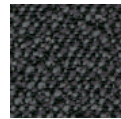

S800013



S800014

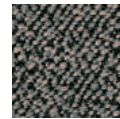

S800015

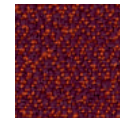

S800016

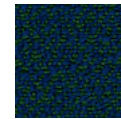

S800017

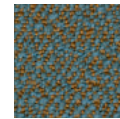

S800018

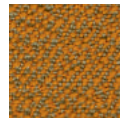

S800019

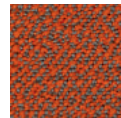

S800020

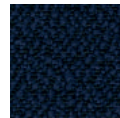

S800021

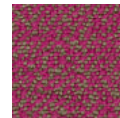

S800022

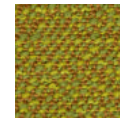

S800023

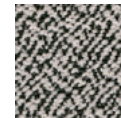

S800027

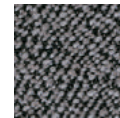

S800028

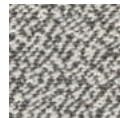

S800029

Available only for Aston Club collection.



Arper grade  
CHAIRS: **Fabthirty**

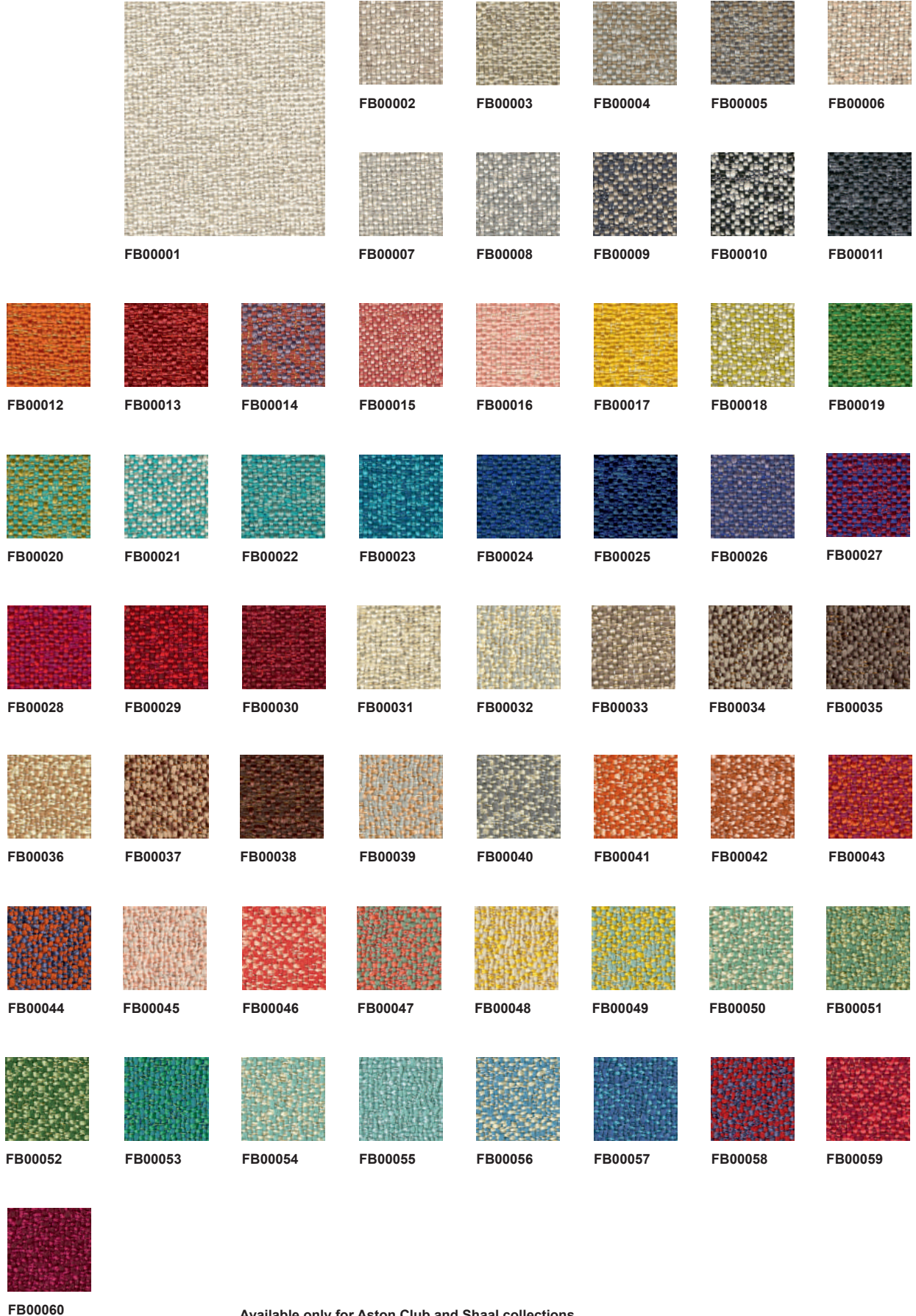

Available only for Aston Club and Shaal collections.



Arper grade  
CHAIRS: C  
SOFAS: C



HE00001



HE00006



HE00009



HE00011



HE00012



HE00015



HE00016

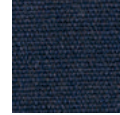

HE00017

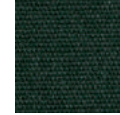

HE00018



HE00021

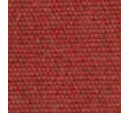

HE00022



HE00023



Arper grade  
CHAIRS: C  
SOFAS: C

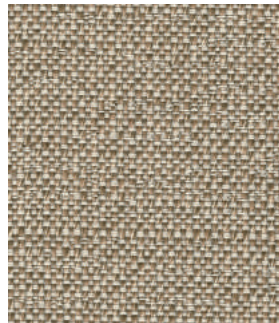

SV00233

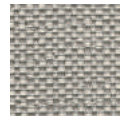

SV00234

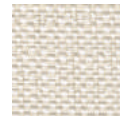

SV00235

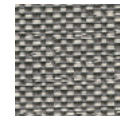

SV00236

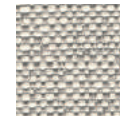

SV00349

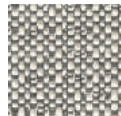

SV00350

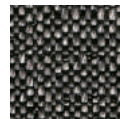

SV00351

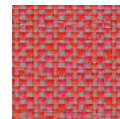

SV00352



SV00353



SV00354



SV00355





Istituito nel 1992, il marchio comunitario di qualità ecologica o Ecolabel, il cui logo è rappresentato da un fiore, è uno speciale sistema di certificazione creato per aiutare i consumatori europei a scegliere prodotti e servizi più ecologici e più rispettosi dell'ambiente.

Established in 1992, the EU Eco-label "Flower" is a unique certification scheme aimed to help European consumers distinguish greener, more environmentally friendly, products and services.

Hinter der "Blume", dem 1992 ins Leben gerufenen EU-Umweltzeichen, steckt ein einzigartiges Zertifizierungssystem, das dem europäischen Verbraucher das Erkennen umweltfreundlicherer Produkte und Dienstleistungen erleichtern soll.

Établi en 1992, le label écologique de l'EU symbolisé par la "Fleur" est un système d'homologation unique destiné à aider les consommateurs européens à discerner les produits et services plus verts et plus favorables à l'environnement.

Creada en 1992, la etiqueta ecológica de la UE, también conocida como "la flor", constituye un sistema de certificación único, cuyo objetivo es ayudar a los consumidores europeos a identificar los productos y servicios más ecológicos y respetuosos del medio ambiente.

## Finishes – Colors correspondence chart

Materials	Description	Colour
<b>ABS</b>		
A11	White	RAL 9003
A14	Black	RAL 9004
<b>Polyurethane</b>		
PU00001	White	RAL 9003
PU00004	Black	RAL 9004
PU00007	Moka	RAL 8019
PU00008	Green	PANTONE 390 U
<b>Polypropylene</b>		
PA00001	White	RAL 9003
PA00002	Black	RAL 9005
PC00001	White	NCS S 0500-N
PC00002	Black	NCS S 8500-N
PC00003	Terracotta	NCS S 3020-Y70R
PC00004	Rust	NCS S 4040-Y70R
PC00005	Clear Blue/grey	NCS S 4005-B80G
PD00001	Ivory	NCS S 2005-Y20R
PD00002	Bark brown	NCS S 7005-Y80R
PD00003	Olive green	NCS S 6010-G90Y
PD00004	Black	NCS S 8500-N
PG0001	White	NCS S 0500-N
PG0002	Sand	NCS S 2005-Y20R
PG0003	Sage green	NCS S 3010-G20Y
PG0004	Blue grey	NCS S 4020-R90B
PG0005	Yellow	NCS S 2070-Y
PG0006	Black	NCS S 8500-N
PG00011	Black	NCS S 1002-Y
PG00012	Rust	NCS S 4040-Y70R
PG00013	Green olive	NCS S 3010-G20Y
PG00014	Neptune blue	NCS S 7020-R90B
PG00015	Snow white	NCS S 8500-N

<b>Materials</b>	<b>Description</b>	<b>Colour</b>
PM00001	White	NCS S 0500-N
PM00002	Black	NCS S 8500-N
PM00003	Rust	NCS S 4040-Y70R
PM00004	Olive green	NCS S 6010-G90Y
PM00005	Dark blue	NCS S 8010-R90B
PP0001	White	RAL 9003
PP0004	Turtledove grey	NCS S 4005Y20R
PP0005	Anthracite	NCS S 7500-N
PP0006	Black	RAL 9004
PS00001	White	RAL 9003
PS00002	Black	NCS S 8500-N
PS00003	Petrol	NCS S4010-B50G
PS00004	Rust	NCS S4040-Y70R
PS00005	Ivory	NCS S2005-Y20R
PT00011	Snow White	NCS S 8500-N
PT00012	Sage green	NCS S 3010-G20Y
PT00013	Rust	NCS S 4040-Y70R
PT00014	Turtledove grey	NCS S 4005-Y20R
PT00015	Anthracite	NCS S 6502-G
PT00016	Black	NCS S 1002-Y
P25	Black	NCS S 8500-N
P63	Rust	NCS S 4040-Y70R
P65	Green olive	NCS S 6010-G90Y
P67	Neptune blue	NCS S 7020-R90B
P68	Snow white	NCS S 1002-Y

<b>Materials</b>	<b>Description</b>	<b>Colour</b>
<b>Monocolour</b>		
PO00101	White	RAL 9003
PO00104	Dark brown	RAL 8019
PO00105	Red	RAL 3020
PO00109	Black	RAL 9004
PO00112	Anthracite	NCS S 7500-N
PO00113	Ivory	NCS S 2500-Y20R
PO00114	Turtledove grey	NCS S 4500-Y20R
PO00115	Yellow	NCS S 4500-G20Y
PO00116	Rosé	NCS S 3020-Y80R
PO00117	Petrol	NCS S 4010-B50G
PO00118	Green	PANTONE 390 U
PO00401	White	RAL 9003
PO00404	Dark brown	RAL 8019
PO00409	Black	RAL 9004
PO00412	Anthracite	NCS S 7500-N
PO00413	Ivory	NCS S 2005-Y20R
PO00415	Yellow	NCS S 1070-G90Y
PO00419	Caramel	NCS 4040-Y30R
PO00420	Sand	RAL 1001
<b>Bicolour</b>		
PO00204	White-dark brown	RAL 9003-8019
PO00205	White-red	RAL 9003-3020
PO00209	White-black	RAL 9003-9004
PO00212	White-anthracite	RAL 9003-NCS S 7500N
PO00213	White-ivory	RAL 9003-NCS S 2005-Y20R
PO00214	White-turtledove grey	RAL 9003-NCS S 4005-Y20R
PO00215	White-yellow	RAL 9003-NCS S 1050-G90Y
PO00216	White-rosé	RAL 9003-NCS S 3020-Y80R
PO00217	White-petrol	RAL 9003-NCS S 4010-B50G
PO00218	White-green	RAL 9003-PANTONE 390 U

Materials	Description	Colour
<b>Metals</b>		
CRO	Chrome finish steel	
LU1	Shiny aluminium/steel	
S03	Brushed stainless steel	
V12	White powdercoated	RAL 9003
V13	Green powdercoated	PANTONE 390 U
V14**	Space grey	
V15**	Anthracite grey	
V16**	Copper	
V22	White powdercoated	RAL 9010
V24	White powdercoated	NCS S 0500-N
V25	Black powdercoated	NCS S 8500-N
V34	Mocha powdercoated	RAL 8019
V39	Black powdercoated	RAL 9005
V44**	Noir sable powdercoated	
V48	Red powdercoated	RAL 2002
V53	Ivory powdercoated	NCS S 2005-Y20R
V54	Turtledove grey powdercoated	NCS S 4005-Y20R
V55	Yellow powdercoated	NCS S 1050-G90Y
V56	Rosé powdercoated	NCS S 3020-Y80R
V57	Petrol powdercoated	NCS S 4010-B50G
V59	Blue	NCS S 8010-R70B
V60	Green	NCS S 7020-G10Y
V61	Red earth	NCS S 5040-Y70R
V62	Yellow ochre	NCS S 5040-Y10R
V63	Rust	NCS S 4040-Y70R
V64**	Bark brown	
V65	Olive green	NCS S 6010-G90Y
V66	Dark blue	NCS S 8010-R90B
V67	Neptune blue	NCS S 7020-R90B
V68	Snow white	NCS S 1002-Y
<b>Compact HPL</b>		
H02	White	NCS S 0502-G50Y
H03	Black	NCS S 9000-N
H04	Grey	

Materials	Description	Colour
<b>Melamine</b>		
N01	White	NCS S 0502-G50Y
N02	Black	NCS S 9000-N
<b>MDF</b>		
M02	White	RAL 9003
M04	Black	RAL 9005
M08	Moss green	NCS S 5020-G50Y
M09	Red clay	NCS S 4030-Y60R
M18	Autumn yellow	NCS S 6020 Y
M19	Dijon yellow	NCS S 4030 Y10R
M20**	Sandy black	RAL 2100
M21	Ginger yellow	NCS S 1050 Y10R
M24	Traffic white	NCS S 0500 N
M25	Black	NCS S 8500 N
M30	Oxidised red	NCS S 6020 Y90R
M38	Siena red	NCS S 4030 Y70R
M67	Neptune blue	NCS S 7020 R90B
M69	Coral pink	NCS S 1050 Y70R
M70	Tourmaline green	NCS S 7010 B90G
M71	Antique green	NCS S 5010 G10Y
M72	Prehnite green	NCS S 1020 G10Y
M73	North Sea blue	NCS S 5030 B
M74	Sky blue	NCS S 1020 B
M75	Warm grey	NCS S 2500N
M76	Midnight blue	NCS S 7020 R70B
M77	Forest green	NCS S 8010 B70G
M78	Jaipur pink	NCS S 5020 Y70R
<b>MDF + laminate</b>		
M34	Dark brown + White	RAL 8019-RAL 9003
M39	Black + White	RAL 9004-RAL 9003
M48	Red + White	RAL 2002-RAL 9003
M53	Ivory + White	NCS S2005-Y20R-RAL 9003
<b>Laminates</b>		
LM00022	Effect natural oak	
LM13	Effect black oak	

<b>Materials</b>	<b>Description</b>	<b>Colour</b>
<b>Fenix</b>		
F01*	White	NCS S 0500-N / RAL 9016
F02*	Black	NCS S 8500-N
F06*	Bromo grey	NCS S 6502-B / RAL 7012
<b>Porcelain stoneware</b>		
C10	Clear	
C11	Dark	
<b>Venetian Terrazzo</b>		
B10	Clear	
B11	Dark	
<b>Wood</b>		
L14	Walnut	
L15	Maple	
L21	Wengé oak	
L22	Natural oak	
L0006	Black oak	
L0009	Natural birch effect	
L0010	Stained birch effect, oak	
L0011	Stained birch effect, walnut	
L0012	Stained birch effect, white	
L0013	Stained birch effect, black	
L0020	Bleached oak	
L0021	Wengé oak	
L0022	Natural oak	
L0023	Teak effect	
L0027	Heat-treated oak	
L0028	Walnut	

Materials	Description	Colour
<b>Marble</b>		
B01		
<b>Glass</b>		
V02		
<b>MDF + Glass</b>		
V75	Warm grey	NCS S 2500N
V76	Midnight blue	NCS S 7020 R70B
V77	Forest green	NCS S 8010 B70G
V78	Jaipur pink	NCS S 5020 Y70R

**NCS / RAL / PANTONE codes refer to the masters used for the colours. Surface finishes may cause slight variations in appearance relative to the indicated references.**

**\* The above references are not perfect equivalences, they are the best available match.**

**\*\* Finishes without colour reference, please request a sample.**



# Care instructions

## **Fabrics:**

It is important that fabrics are cleaned regularly in order to keep them looking their best and extend their life. Powder and dirt can cause wear and tear on fabrics and as such we advise that you clean them using a low-pressure vacuum cleaner, preferably once a week.

Non-greasy stains can be removed by delicately dabbing them with a clean cloth that won't leave any lint or a sponge that has been soaked in clean, warm water then thoroughly squeezed out. If necessary, you can then soak with soapy water or water with liquid washing up detergent added (see formulas). Once this is done, soak the surface with clean, tepid water.

For greasy stains, use a dry stain remover. Ensure that you comply with the manufacturer's instructions as closely as possible. If you have any doubts, test the cleaning product on a discreet area in order to check its effect. Wait for at least 24 hours to see if any problems arise.

**Formulas:** The soapy solution consists of ¼ deciliter soap flakes per liter of hot water, which must then be cooled before use. The solution with dishwashing liquid is made up of max 1 teaspoon of detergent per every liter of water. If you use concentrated products, pour only a few drops into each liter of product.

## **Coated fabrics:**

Regularly dust using a microfibre cloth. In the event of stains, clean using a cloth that has been dampened using tepid water or water with some neutral soap in it. Do not use abrasive products, ethyl alcohol and solvent-based detergents. If you have any doubts, test the cleaning product on a discreet area in order to check its effect. Wait for at least 24 hours to see if any problems arise.

## **Structural mesh in knitted fabric:**

Made to Arper's technical specifications with post-consumption recycled polyester yarns, the knitted fabric mesh is soft and comfortable. The particular structure makes it self-draining and breathable, this ensures rapid passage of the water and makes it quick drying. It has excellent resistance to weathering, humidity and temperature changes, also thanks to the addition of anti-UV stabilisers that prevent and slow down natural ageing without the addition of substances dangerous to the environment or to health. **Maintenance:** It is important to regularly clean the fabric in order to maintain its appearance in the best conditions and to extend its life. Dust and dirt wear out the fabric, so it is recommended to clean it with low suction vacuum cleaners, preferably once a week. Non-grease stains are eliminated by gently dabbing them with a clean cloth that leaves no residue or a sponge immersed in clean hot water and then well squeezed. If necessary, wash by dipping the cloth used for cleaning in soapy water or water with the addition of liquid dishwashing detergent (see formulas). Then dab

the surface with clean warm water, letting it dry completely.

For grease stains, it is possible to use dry stain removers, scrupulously following the manufacturer's instructions.

Do not use hot steam, do not dry with electrical appliances with temperatures above 50°C. Do not use abrasive substances or chemical solvents.

In case of doubt, test the cleaning product on a part hidden from view to verify the result, waiting at least 24 hours for any problems to arise.

**Formulas:** The soapy solution consists of 1/4 dl of soap flakes for each litre of hot water, which then needs to be cooled before use. The solution with liquid dishwashing detergent consists of up to 1 teaspoon of detergent per litre of water. If you use concentrated products, pour only a few drops into each litre of product.

## **Leather, hard leather:**

Take care not to place products in direct sunlight as this can alter the colour of these materials. Avoid exposing the materials to heat sources.

Regularly dust using a soft, dry cloth. Any stains need to be removed as quickly as possible to prevent them from soaking in deeply. Use absorbent paper or a cloth to absorb them straight away. For cleaning, use specific, high-quality leather cleaning products and comply with the manufacturer's instructions as closely as possible.

If you have any doubts, test the cleaning product on a discreet area in order to check its effect. Wait for at least 24 hours to see if any problems arise. Alternatively, use a cloth that has been dampened with some water and well-diluted neutral soap. Do not rub. Instead, delicately dab the stain working from the edge into the centre, then dry immediately after treatment.

## **Wood:**

Dust and common domestic stains can be removed using a solution made from water and well-diluted neutral soap. Under no circumstances should you use commercial stain removers for cleaning. In order to avoid scratching the products, use a soft cloth and clean using circular movements. Do not use solvents or abrasive products. Always dry surfaces using a dry cloth. If you have any doubts, test the cleaning product on a discreet area in order to check its effect. Wait for at least 24 hours to see if any problems arise.

## **Wood for outdoor use:**

Wood is a natural material suitable for outdoor use. For a sustainable approach, Arper selects only essences from Europe within an FSC certified chain of custody. The use of water-based paints, safe for health and the environment, guarantees a high level of protection and durability for outdoor use, with a reduced

# Care instructions

## **Fabrics:**

It is important that fabrics are cleaned regularly in order to keep them looking their best and extend their life. Powder and dirt can cause wear and tear on fabrics and as such we advise that you clean them using a low-pressure vacuum cleaner, preferably once a week.

Non-greasy stains can be removed by delicately dabbing them with a clean cloth that won't leave any lint or a sponge that has been soaked in clean, warm water then thoroughly squeezed out. If necessary, you can then soak with soapy water or water with liquid washing up detergent added (see formulas). Once this is done, soak the surface with clean, tepid water.

For greasy stains, use a dry stain remover. Ensure that you comply with the manufacturer's instructions as closely as possible. If you have any doubts, test the cleaning product on a discreet area in order to check its effect. Wait for at least 24 hours to see if any problems arise.

**Formulas:** The soapy solution consists of ¼ deciliter soap flakes per liter of hot water, which must then be cooled before use. The solution with dishwashing liquid is made up of max 1 teaspoon of detergent per every liter of water. If you use concentrated products, pour only a few drops into each liter of product.

## **Coated fabrics:**

Regularly dust using a microfibre cloth. In the event of stains, clean using a cloth that has been dampened using tepid water or water with some neutral soap in it. Do not use abrasive products, ethyl alcohol and solvent-based detergents. If you have any doubts, test the cleaning product on a discreet area in order to check its effect. Wait for at least 24 hours to see if any problems arise.

## **Structural mesh in knitted fabric:**

Made to Arper's technical specifications with post-consumption recycled polyester yarns, the knitted fabric mesh is soft and comfortable. The particular structure makes it self-draining and breathable, this ensures rapid passage of the water and makes it quick drying. It has excellent resistance to weathering, humidity and temperature changes, also thanks to the addition of anti-UV stabilisers that prevent and slow down natural ageing without the addition of substances dangerous to the environment or to health. Maintenance: It is important to regularly clean the fabric in order to maintain its appearance in the best conditions and to extend its life. Dust and dirt wear out the fabric, so it is recommended to clean it with low suction vacuum cleaners, preferably once a week. Non-grease stains are eliminated by gently dabbing them with a clean cloth that leaves no residue or a sponge immersed in clean hot water and then well squeezed. If necessary, wash by dipping the cloth used for cleaning in soapy water or water with the addition of liquid dishwashing detergent (see formulas). Then dab

the surface with clean warm water, letting it dry completely.

For grease stains, it is possible to use dry stain removers, scrupulously following the manufacturer's instructions.

Do not use hot steam, do not dry with electrical appliances with temperatures above 50°C. Do not use abrasive substances or chemical solvents.

In case of doubt, test the cleaning product on a part hidden from view to verify the result, waiting at least 24 hours for any problems to arise.

**Formulas:** The soapy solution consists of 1/4 dl of soap flakes for each litre of hot water, which then needs to be cooled before use. The solution with liquid dishwashing detergent consists of up to 1 teaspoon of detergent per litre of water. If you use concentrated products, pour only a few drops into each litre of product.

## **Leather, hard leather:**

Take care not to place products in direct sunlight as this can alter the colour of these materials. Avoid exposing the materials to heat sources.

Regularly dust using a soft, dry cloth. Any stains need to be removed as quickly as possible to prevent them from soaking in deeply. Use absorbent paper or a cloth to absorb them straight away. For cleaning, use specific, high-quality leather cleaning products and comply with the manufacturer's instructions as closely as possible.

If you have any doubts, test the cleaning product on a discreet area in order to check its effect. Wait for at least 24 hours to see if any problems arise. Alternatively, use a cloth that has been dampened with some water and well-diluted neutral soap. Do not rub. Instead, delicately dab the stain working from the edge into the centre, then dry immediately after treatment.

## **Wood:**

Dust and common domestic stains can be removed using a solution made from water and well-diluted neutral soap. Under no circumstances should you use commercial stain removers for cleaning. In order to avoid scratching the products, use a soft cloth and clean using circular movements. Do not use solvents or abrasive products. Always dry surfaces using a dry cloth. If you have any doubts, test the cleaning product on a discreet area in order to check its effect. Wait for at least 24 hours to see if any problems arise.

## **Wood for outdoor use:**

Wood is a natural material suitable for outdoor use. For a sustainable approach, Arper selects only essences from Europe within an FSC certified chain of custody. The use of water-based paints, safe for health and the environment, guarantees a high level of protection and durability for outdoor use, with a reduced

# Care instructions

## **Indications for use & maintenance of “outdoor” products:**

Arper guarantees, through laboratory tests, the strength and durability of its products. It should be noted, however, that any material exposed to atmospheric agents and the elements, even if treated specifically for outdoor use, will undergo a gradual deterioration over time, the extent of which is closely related to the geographical position, the evolution of climatic phenomena, the more or less marked presence of humidity, salinity (poolside, marine environments).

Use and maintenance are conditions that determine the actual yield and maintenance in good condition of the product over time. It is therefore recommended to avoid critical external conditions such as prolonged and direct exposure to sunlight, pouring rain and aggressive environments such as proximity to the seaside or where the sea breeze can bring high levels of moisture with marine salinity or abrasive sands. Do not place wooden products on lawns or uneven surfaces, where any stagnation of water may damage the parts in contact. In any case, never let water or other liquids stagnate on the product. In the vicinity of plants or trees, remove any leaves, flowers or organic substances that could rest on the surfaces of the product, to prevent that their deterioration stains the paints or fabrics. In case of exposure to rain, as soon as possible, remove the pillows (if any) from the chair and let them dry separately to facilitate drying and drainage of the water.

Periodic cleaning is recommended, following the recommended indications for the different materials. For short periods when the product is not in use, it is recommended to cover it with the protective cover. In case of prolonged non-use or during the winter period, it is recommended to clean the product, allow it to dry well, and store it in a well-aerated indoor place, protected from the elements. The pillows (if any) must be removed from the chair, cleaned and left to dry well, and finally, stored in a well-aerated indoor place, protected from the elements.

I colori visualizzati sono puramente indicativi e possono variare rispetto alla realtà. Rivolgersi ad Arper o al proprio rivenditore di fiducia per ricevere un campione colore o per maggiori informazioni.

Arper SPA si riserva di apportare modifiche e/o migliorie di carattere tecnico ed estetico ai propri modelli e prodotti in qualsiasi momento e senza preavviso.

Per maggiori informazioni visitate il sito [arper.com](http://arper.com)

Colours shown are used for reference only and may look different in reality. Please contact Arper or your retailer to receive a colour sample or more information.

Arper SPA reserves the right to make modifications and improvements of a technical or aesthetic nature to the products at any time without notice.

For further information, please visit [arper.com](http://arper.com)

Bei den angezeigten Farben handelt es sich um reine Farbbeispiele, die von der Realität abweichen können.

Für Farbmuster und nähere Informationen wenden Sie sich bitte an Arper oder an den Händler Ihres Vertrauens.

Arper SPA behält sich das Recht vor, jederzeit und ohne Vorankündigung Veränderungen und Verbesserungen technischen und ästhetischen Charakters an seinen Produkten vorzunehmen.

Für weitere Informationen besuchen Sie bitte unsere Webseite [arper.com](http://arper.com)

La reproduction photographique des couleurs n'est que purement indicative et peut être différente de la réalité. S'adresser à Arper ou à votre revendeur de confiance pour recevoir un échantillon de couleur ou pour de plus amples informations.

Arper SPA se réserve le droit d'apporter des modifications et/ou des améliorations d'ordre technique et esthétique à ses produits, et ceci à tout moment et sans préavis.

Pour plus d'informations, rendez-vous sur le site [arper.com](http://arper.com)

Los colores visualizados son meramente indicativos y pueden diferir de la realidad. Para recibir una muestra del color o para más información, contactar a Arper o a su distribuidor de zona. Arper SPA se reserva el derecho de realizar cambios y/o mejoras técnicas y estéticas en sus productos en cualquier momento y sin previo aviso.

Para más información, visite [arper.com](http://arper.com)



## Italy

Monastier (TV) — Headquarters  
and showroom  
Arper SPA  
Via Lombardia 16  
31050 Monastier di Treviso (TV)  
T +39 0422 7918  
info@arper.com  
www.arper.com

Commerciale Italia  
T +39 0422 791905  
commerciale@arper.com

Export Office  
sales@arper.com

Milan — Showroom  
Via Pantano 30  
20122 Milan  
T +39 02 89093865  
milano@arper.com

## **EUROPE**

### UK

London — Subsidiary and showroom  
Arper UK LTD  
11 Clerkenwell Road  
London EC1M 5PA  
T +44 (0) 20 7253 0009  
london@arper.com

### Germany

Cologne — Showroom  
Design Post Köln  
Deutz-Mülheimer-Str. 22a  
50679 Köln  
T +49 221 690 650  
info@designpost.de

Fruchtof München — Meeting Hub  
2. Innenhof, 2. Etage  
Gotzinger Straße 52b  
D-81371 München  
T +49 171 1080976  
muenchen@arper.com

### Norway

Oslo — Showroom  
Drammensveien 130  
0277 Oslo  
T +47 908 202226  
norway@arper.com

### Sweden

Stockholm — Branch  
T +46 705 101216  
sweden@arper.com

## The Netherlands

Amsterdam — Showroom  
Design Post  
Cruquiusweg 111-L  
1019 AG Amsterdam  
T +31 (0)20 705 1555  
holland@arper.com

## **AMERICA**

### USA

New York — Subsidiary and showroom  
Arper USA Inc.  
476 Broadway, Suite 2F  
NY 10013 New York  
T +1 (212) 647 8900  
infousa@arper.com

Chicago — Showroom  
The Merchandise Mart  
Space#346 - 3rd Floor  
Chicago  
T +1 (336) 434 2366  
infousa@arper.com

High Point, North Carolina — Production  
and logistics site  
660 Southwest St  
High Point, NC 27260  
T +1 (336) 434 2370  
infousa@arper.com

Los Angeles — Showroom  
550 South Hope St., Suite 275  
90071 Los Angeles  
T +1 (336) 434 2382  
infousa@arper.com

### Mexico

Mexico City — Subsidiary and showroom  
Culiacan 123, Piso 9  
Col. Hipodromo Condesa  
Delegation Cuauhtémoc  
06170 – Ciudad de México  
Mexico  
T +52 1 62714417  
infolatam@arper.com

## **ASIA**

### Japan

Arper Japan K.K. — Subsidiary  
and showroom  
HT Jingu Gaien Bldg.8F  
Minato-ku Kita-Aoyama 2-7-22  
Tokyo 107-0061  
T +81 3 5775 0008  
carejpn@arper.com

### China

Shanghai — Subsidiary  
爱尔派 (上海) 家具设计有限公司  
2nd Floor, Unit N204-207,  
Building N1,  
The Bund Finance Center,  
558 Zhongshan NO.2 Road(E),  
Shanghai  
T +86 021 5466 7366  
china@arper.com

### Singapore

Singapore — Branch  
c/o 3 Lim Teck Kim Road, #01-01  
Genting Centre  
088934 Singapore  
singapore@arper.com

### UAE

Arper Middle East and India  
— Subsidiary  
and showroom  
U-Bora Towers - Unit 1901  
Business Bay  
Dubai  
T +971 529255633  
infome@arper.com

**arper**