



MAGNUS OLESEN ^A/_S

PRICE LIST APRIL 2023
RETAIL PRICES EXCL. VAT
PRICES IN SEK

SENAB

Färgmarkeringar och/eller symboler för hållbara alternativ i prislistan:

Mörkgrön markering eller symbol

Miljömärkt produkt – Möbler där hela den sammansatta varan har en typ 1 miljömärkning enligt ISO 14024 med Svanen, Möbelfakta, EU Ecolabel eller annan likvärdig märkning.

Ljusgrön markering eller symbol

Hållbarhetsmärkt produkt eller beståndsdel – Möbler där hela eller delar av den sammansatta varan är hållbarhetsmärkt, exempelvis med FSC, EU Ecolabel eller OEKO-TEX®. Leverantören ska kunna ge mer detaljerad information om vilka delar eller variationer som är hållbarhetsmärka vid begäran.

Orange markering eller symbol

Klimatberäknad produkt – Produkt med dokumenterad miljövarudeklaration (EPD) enligt ISO 14025.

Lila markering eller symbol

Produkt med återvunnet eller förnybart material (enligt definitionerna i ISO 14021). Leverantören ska kunna ge information om andel (%) återvunnet och/eller förnybart (biobaserat) vid begäran. Märkning av återvinningsbart material utgår.

Blå markering eller symbol

Demonterbar produkt – Produkt som är demonterbar till olika komponenter och beståndsdelar som i första hand möjliggör återbruk och i andra hand materialåtervinning när produkten nått sin fulla livslängd. Produkten ska vara designad för renovering, det vill säga att det ska vara enkelt att reparera och byta ut moduler, komponenter och beståndsdelar som slits över tid. Exempelvis ska ytskikt, som bordsskivor, textil och stoppning kunna tas isär, avlägsnas och ersättas med hjälp av vanligt förekommande manuella verktyg, ej specialverktyg. Enklare reparationer och utbytesarbeten ska kunna utföras av en lekman. Om det krävs fackmanakunskap för mer avancerade arbeten ska det framgå av anvisningarna som leverantören ska kunna ge vid begäran. Anvisningarna ska innehålla en sprängskiss, steg för steg beskrivning inklusive vilka verktyg som krävs samt hur möbelns ingående delar bör källsorteras.

INDEX

INDEXS	2
DANISH DESIGN	3
GOOD DESIGN, THAT LASTS	4
QUICK SHIP	5

SERIES

8000 SERIES	6
8000 SERIES CHAIR	7
8000 SERIES STOOL	8
X-LINE SERIES	9
X-LINE CHAIR	10
X-LINE TABLE	11
FREYA SERIES	12
FREYA	13
FREYA TWO	14
FREYA ARM	15
FREYA LOUNGE	16
FREYA BENCH	17
FREYA DESK	18
FREYA COFFEE TABLE	19
FREYA DINING TABLE	20
BUTTERFLY SERIES	21
BUTTERFLY WITH 4 STEEL LEGS	22
BUTTERFLY WITH 4 STEEL LEGS & ARM	23
BUTTERFLY SWIVEL	24
BUTTERFLY SWIVEL WITH ARMREST	25
BUTTERFLY SWIVEL HIGH	26
BUTTERFLY SWIVEL HIGH WITH ARM	27
BUTTERFLY WOOD	28
BUTTERFLY CLASSIC ARMCHAIR	29
BUTTERFLY CLASSIC LOUNGE	30
BUTTERFLY CLASSIC 2-SEATER	31
BUTTERFLY BAR	32
MODEL 107 SERIES	33
MODEL 107 LOUNGE CHAIR	34
MODEL 107 2-SEATER	35
MODEL 107 COFFEE TABLE	36
XYLOFON SERIES	37
XYLOFON SEATING	38
XYLOFON TABLES	39

SEATING LINES

Ø CHAIR	40
Ø CHAIR - 9 SELECTED VARIANTS	41
Ø CHAIR	42
PAUSE	43
PAUSE	44
PAUSE WITH ARMREST	45
PAUSE WITH ARMREST (FORWARD)	46
PAUSE RUNNER	47
PAUSE BAR STOOL	48
INFERNO	49
INFERNO	50
SESSION SERIES	51
SESSION PURE	52
SESSION	53
SESSION RELAX	54
45-SERIES	55
45-SERIES	56
45-SERIES WITH ARMREST	57
TONICA WOOD	58
TONICA WOOD	59
TONICA WOOD WITH ARMREST	60
SOLACIA	61
SOLACIA CHAIR & STOOL	62
ADDI MEETING	63
ADDI MEETING	64

TABLE LINES

SLENDER	65
SLENDER	66
SLENDER COFFEE TABLE	67
MIX TABLE SERIES	68
MIX, FINGER JOINT WOODEN LEGS	70
MIX WITH CONICAL WOODEN LEGS	73
BRUNCH TABLE SERIES	76
BRUNCH WITH STEEL LEGS	78
BRUNCH WITH CONICAL WOODEN LEGS	79
CONTACT	80
CONTACT	81
CONTACT	82
TRIO	83
TRIO	84
BAR TABLE WOOD	85
BAR TABLE WOOD	86
MEETING TABLE	87
MEETING TABLE	88
FABRIC, LEATHER & ARTIFICIAL LEATHER	89
TERMS OF SALE AND DELIVERY	91

DANISH DESIGN - WITH PRODUCTION IN DENMARK



GOOD DESIGN, THAT LASTS

Magnus Olesen has manufactured functional, durable yet aesthetic design since 1937 - Made in Denmark.

Magnus Olesen A/S was founded in 1937 with a strong belief in Danish Design and craftsmanship. It is today a well-reputed furniture company, developing and manufacturing design furniture of high quality and durability. Over the course of time it has worked with well-respected designers such as Danish Modern designer Ib Kofod-Larsen in the 1950s, Rud Thygesen & Johnny Sørensen in the 1970s & 1980s, Says Who and Øivind Slaatto today – always remaining true to its design roots but still keeping up with the developments of time.

Due to its design history, Magnus Olesen A/S has built an extensive portfolio of both Danish classics as well as contemporary designs. Today, the designs can be seen in a multitude of architectural projects as well as in private homes. Magnus Olesen has always been focused on longevity and sustainability – good design, that lasts. The company has its production in Durup, Denmark. The showroom of Magnus Olesen is placed in beautiful surroundings in the center of Copenhagen.

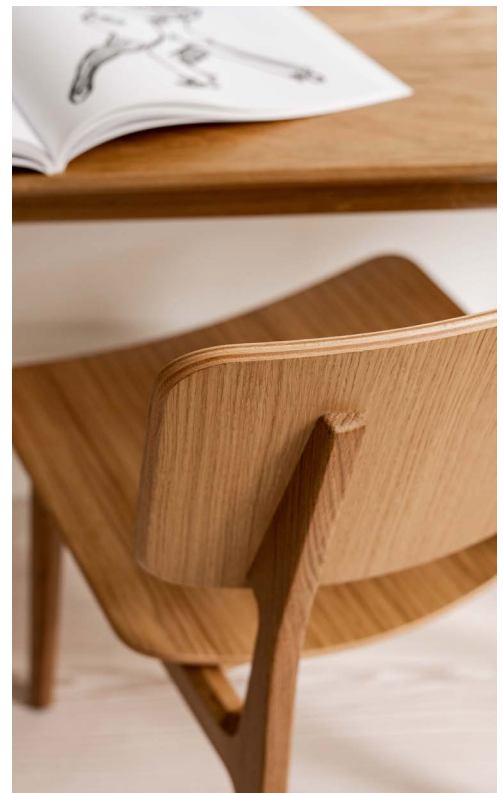

GOOD DESIGN, THAT LASTS

“Not just any design will be put in production at Magnus Olesen. A design is considered as good design, when both the visual expression and well thought out function meet the environmental requirements we work with.”

– Nils Knudsen, Owner & CEO, Magnus Olesen A/S

PRODUCTION IN DENMARK

We believe in Danish craftsmanship and have produced in Denmark ever since 1937. Wood and other raw materials are converted into chairs and tables locally in Denmark. With our factory in Denmark we work purposefully for a production that meets the strictest environmental requirements.

RESPONSIBLE USE OF MATERIALS

Magnus Olesen's production is based on sustainable materials. Since 2016, Magnus Olesen has been FSC® certified (FSC® C131817). Our environmental choice applies not only to our wood but also to other materials in our production. For example, recycled materials such as composite material. In addition we offer a number of our tables with 'Honeycomb' material which secures minimal use of material. A number of our products are EU ECOLABEL certified.

CIRCULAR ECONOMY/ DESIGN FOR DISASSEMBLY

We work with circular economy and the majority of our products are designed for disassembly so that they are easy to recycle and reuse. This gives us the opportunity to offer individual 'Take Back' agreements where we upcycle our products for an even longer lifetime.

Magnus Olesen
Good design, that lasts

For more information visit magnus-olesen.com

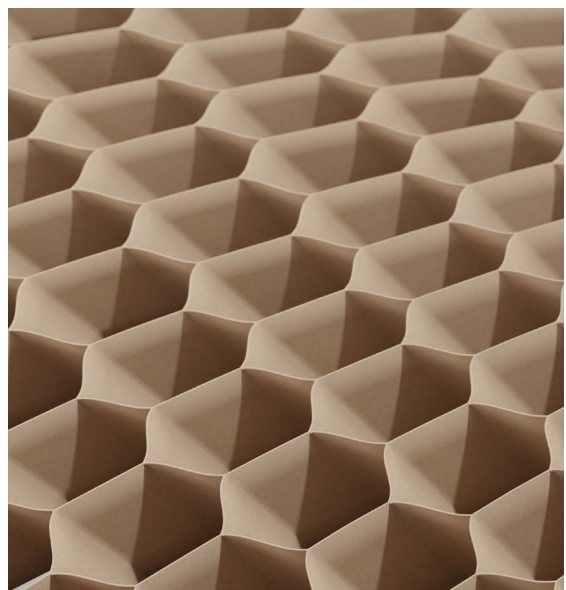

QUICK SHIP

Quick Ship program with selected products that can be shipped in a maximum of 3 weeks from receipt of order. For larger orders, please contact the factory for the current delivery time - contact post@magnus-olesen.dk.

PAUSE

Pause, MO 8661, stackable
Seat and back: Black composite
Steel frame: Matt, black grained lacquer

Ø CHAIR

Ø Chair, MO 2030, stackable
Seat and back in wood: Black painted oak
Steel frame and screw: Matt, black grained lacquer

BUTTERFLY WITH 4 STEEL LEGS

Butterfly with 4 steel legs, MO 5310, stackable
Seat and back shell: Oak with transparent lacquer
Steel frame: Matt, black grained lacquer or bright chrome

FREYA DESK

Freya Desk, MO 4760-1, size 110x45xH74 cm
Table top with black Forbo linoleum, colour no. 4023
Frame, table edge and drawer in wood: Oak with transparent lacquer

MIX TABLE SERIES

Mix tables, MO 7003 with solid, finger joint wooden legs
Table top with black Forbo linoleum, colour no. 4023
Frame and table edge in wood: Oak with transparent lacquer
MO 7003-8, size 80x120xH74 cm
MO 7003-9, size 80x140xH74 cm
MO 7003-11, size 80x180xH74 cm

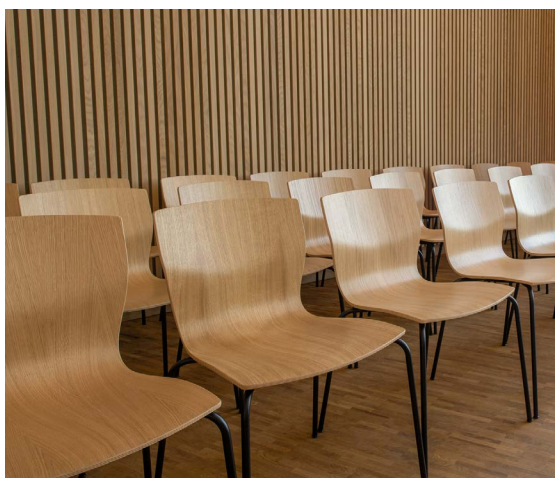

8000 SERIES

DESIGN: (1981) RUD THYGESEN & JOHNNY SØRENSEN

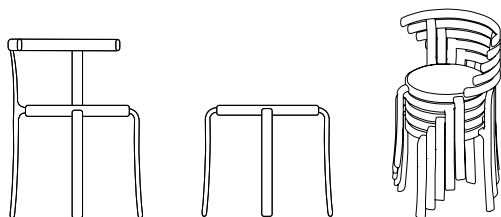

8000 series is a design icon, produced by Magnus Olesen since 1981. The series is based on a unique and patented production technology without the use of screws and dowels, which makes the furniture very flexible and incredibly strong despite its low weight. In 2021, Magnus Olesen brings the 80s to life with a relaunch of the iconic 8000 series chair in 9 new high gloss colours. The series is also available in the same selected colours as the Ø Chair (see more on page 40)

WOOD & TREATMENTS

See product details on the individual product pages

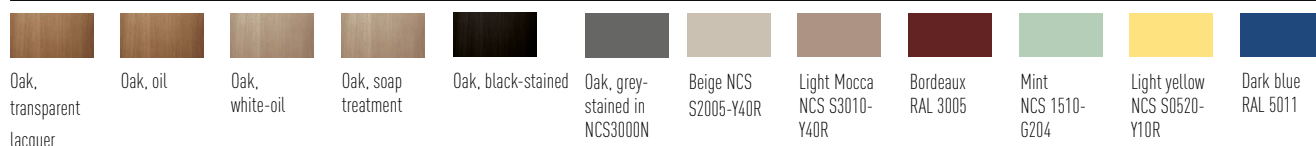

HIGH GLOSS LACQUER COLOURS

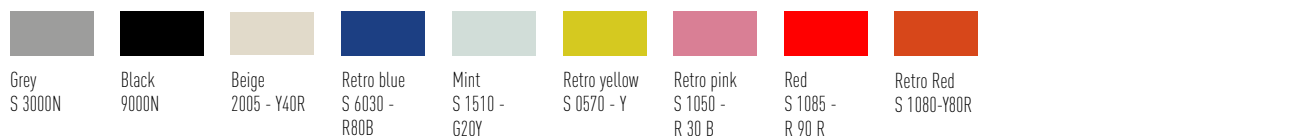

LINOLEUM

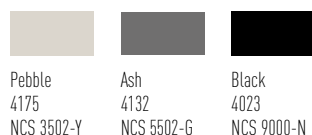

LAMINATE

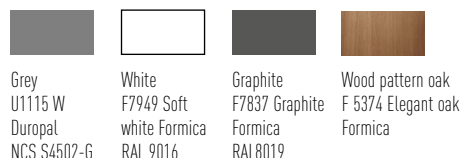

RECOMMENDED FABRIC, LEATHER & ARTIFICIAL LEATHER

GROUP A	GROUP B	GROUP C	LEATHER 1	LEATHER 2
Cura, Main Line Plus	Fame, Illusion, Synergy, Remix 3	Hallingdal 65	Sydney, Hero	Savanne, Vacona

See the overview of fabric, leather and artificial leather on page 89

8000 SERIES CHAIR

DESIGN: (1981) RUD THYGESEN & JOHNNY SØRENSEN

SPECIFICATIONS & MEASUREMENTS

Description	Unique designed stackable chair in oak or high gloss.
Measurement	W53 x D53 x H72 x SH46 cm
Weight	Gross/Net: 4,1/3,8 kg/pc. 6 pcs/cart. 0,31 cbm/cart
Seat	Ø40 cm with option of seat in wood, linoleum, lamiante, or with upholstery
Wood	Laminated beech with top veneer in oak - laquered, oiled, black-stained or in the Ø Chair 7 colours - or in high gloss laquer
Stackable	6 pcs.



8000 SERIES CHAIR

Item No.	Product	Seat in wood	Linoleum Laminate	A	B	C	1	2
MO 8002	Frame in oak	5.250	5.250	5.150	5.320	5.660	5.825	6.085
MO 8002	Frame in oak - black-stained oak or in Ø Chair 7 colours	5.585	5.585	5.985	6.150	6.495	6.660	6.920
MO 8002N	Frame and seat in high gloss	7.500						

ACCESSORIES

Item No.	Product	Prize
MO 1614	4 pcs. felt glides, white - mounted	185
MO 1615	4 pcs. plastic glides, white - mounted	200
MO 1801	Detachable seat top	335

Item No.	Product	A	B	C	1	2
MO 1801	Detachable seat top with upholstery	1.200	1.425	1.695	1.910	2.075

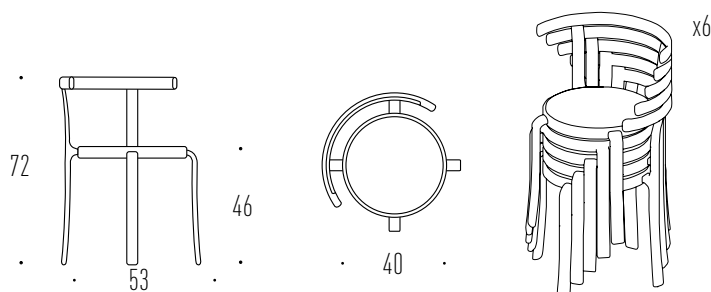

8000 SERIES STOOL

DESIGN: (1981) RUD THYGESEN & JOHNNY SØRENSEN

SPECIFICATIONS & MEASUREMENTS

Description	Unique designed stackable stool in oak or high gloss.
Measurement	W53 x D53 x H46 cm
Weight	Gross/Net: 3,47/3,13 kg/pc. 10 pcs/cart. 0,31 cbm/cart
Seat	Ø40 cm with option of seat in wood, linoleum, laminate, or with upholstery
Wood	Laminated beech with top veneer in oak - laquered, oiled, black-stained or in the Ø Chair 7 colours - or in high gloss laquer
Stackable	Stacks endlessly



8000 SERIES STOOL

Item No.	Product	Seat in wood	Linoleum	A	B	C	1	2
			Laminate					
MO 8000	Frame in oak	3.750	3.750	3.825	3.920	4.250	4.420	4.585
MO 8000	Frame in oak - black-stained oak or in Ø Chair 7 colours	4.085	4.085	4.410	4.500	4.835	5.000	5.170
MO 8000N	Frame and seat in high gloss	5.585						

ACCESSORIES

Item No.	Product	Prize
MO 1614	4 pcs. felt glides, white - mounted	185
MO 1615	4 pcs. plastic glides, white - mounted	200
MO 1801	Detachable seat top	335

Item No.	Product	A	B	C	1	2
		MO 1801	Detachable seat top with upholstery	1.200	1.425	1.695

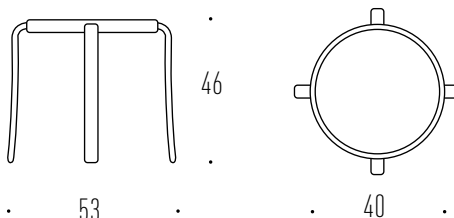

X-LINE SERIES

DESIGN: (1971) NIELS JØRGEN HAUGESEN

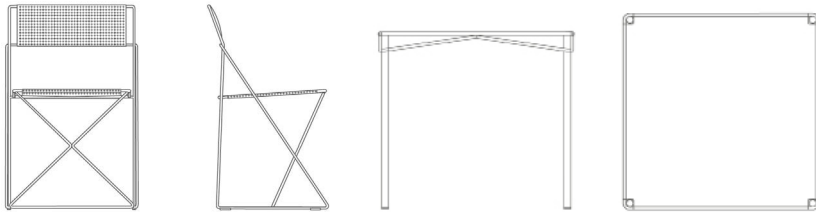

X-Line is an iconic chair designed by the Danish architect, Niels Jørgen Haugesen. The construction is based on a simple and logic design – where the iconic X, plays the central part of the chair’s function, strength and stability. The X-Line table is a natural extension and follows the minimalistic design line from the chair. Relaunched in 2022 in four powder-coat variants, which makes it particularly suitable for outdoor use.

STEEL COLOURS

See product details on the individual product pages



Bright chrome
Indoor use only

POWDER-COAT COLOURS



Black
Monochromatic
RAL5002
Indoor/
outdoor use



Off-White
Mnochromatic
RAL9010
Indoor/
outdoor use



Brown
Monochromatic
RAL8011
Indoor/
outdoor use



Blue
Monochromatic
RAL5002
Indoor/
outdoor use

X-LINE CHAIR

DESIGN: (1977) NIELS JØRGEN HAUGESEN

SPECIFICATIONS & MEASUREMENTS

Description	Iconic stackable chair with the option of 4 lacquered versions suited for outdoor
Measurement	W50 x D45 x H77 x SH46 cm
Weight	Gross/Net: 5,5/5 kg/pc. 4 pcs/cart. 0,240 cbm/cart
Seat and back	Perforated steel
Stackable	Floor: 12 pcs. Trolley: 40 pcs.



X-LINE CHAIR

Item No.	Product	Price
MO 6100	Bright chrome - indoor use	4.920
MO 6100	Powder lacquer - indoor/outdoor use	4.920

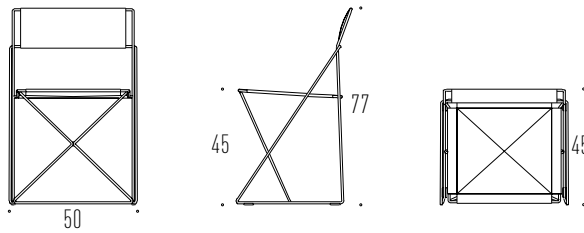

X-LINE TABLE

DESIGN: (1977) NIELS JØRGEN HAUGESEN

SPECIFICATIONS & MEASUREMENTS

Description	The light and simple design gives the table an industrial look. The lacquering makes it particularly suitable for outdoor environments.
Measurement	W80 x D80 x H72 cm
Weight	Gross/Net: 12/14 kg/pc. 1 pcs/cart. 0,145 cbm/cart
Table top	Powder lacquered steel
Frame	Steel tube, powder lacquered in the same colour as the table top



X-LINE TABLE

Item No.	Product	Price
MO 6151	Powder lacquer - indoor/outdoor use	14.995

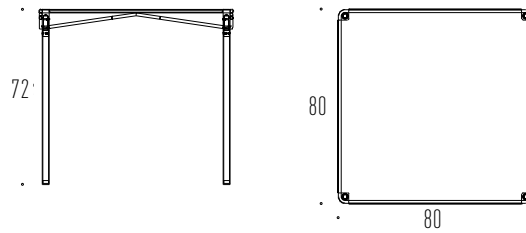

FREYA SERIES

DESIGN: SAYS WHO

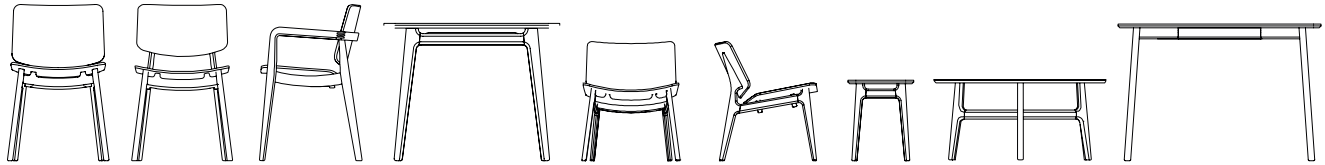

The popular Freya series consists of several furniture products. The design of the Freya series is rooted in classic Danish furniture design but interpreted for present standards. A modern wooden series with an astonishing abundance of understated details, highlighting the high degree of craftsmanship in the Freya series.

WOOD & TREATMENTS

See product details on the individual product pages



Oak, transparent lacquer
Oak, natural oil
Oak, white-oil
Oak, soap treatment
Oak, black-stained

LINOLEUM



Pebble 4175 NCS 3502-Y
Ash 4132 NCS 5502-G
Black 4023 NCS 9000-N

LAMINATE



Grey U1115 W Duopal NCS S4502-G
White F7949 Soft white Formica RAL 9016
Graphite F7837 Graphite Formica RAL8019
Wood pattern oak F 5374 Elegant oak Formica

RECOMMENDED FABRIC, LEATHER & ARTIFICIAL LEATHER

GROUP A	GROUP B	GROUP C	LEATHER 1	LEATHER 2
Valencia, Main Line Plus	Atlas, Remix 3, Illusion	Steelcut Trio	Hero, Sydney	Savanne, Dunes

See the overview of fabric, leather and artificial leather on page 89

CERTIFICATIONS



EU Ecolabel certification on specific products:

Freya (4711)
Freya Armrest (4714)
Freya Lounge (4731)
Freya Lounge with seat and back upholstery (4711)

EU Ecolabel: DK/049/016

FREYA

DESIGN: (2016) SAYS WHO

SPECIFICATIONS & MEASUREMENTS

Description	The chair appears modern with its dynamic lines and elegant profile. It is a beautiful chair with great seating comfort.
Measurement	W50 x D50 x H79 x SH46 cm
Weight	Gross/Net: 7,5/7 kg/pc. 2 pcs/cart. 0,37 cbm/cart
Seat and back	Laminated plywood with oak veneer
Frame	Solid oak



FREYA

Item No.	Product	Without upholstery	A	B	C	1	2
MO 4711	Seat and back in oak	6.660					
MO 4711	Back in oak, seat upholstered		7.750	8.095	8.545	8.820	9.270
MO 4711	Fully upholstered seat and front side upholstered back		8.660	9.575	10.695	11.385	12.535

ADDITIONAL PURCHASE

Item No.	Product	Price
	Frame, seat and back in black-stained oak	835
	Two buttons in front side upholstered back - same fabric as the back	1.285
	Two buttons in front side upholstered back in Savanne leather in selected colours	1.660

ACCESSORIES

Item No.	Product	Price
MO 1617	4 pcs. felt glides, white	185
MO 1638	4 pcs. teflon glides	200
MO 1639	2 built-in castors in front legs	2.000

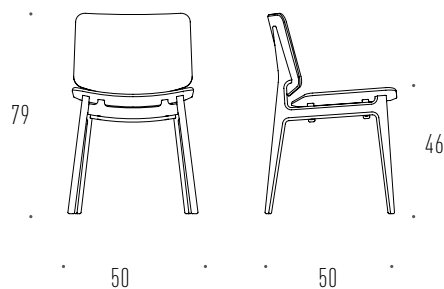

FREYA TWO

DESIGN: (2019) SAYS WHO

SPECIFICATIONS & MEASUREMENTS

Description	Elegant chair with a more narrow back. The Freya Two chair still looks modern with its dynamic alignment and same elegant profile as Freya chair.
Measurement	W50 x D50 x H79 x SH46 cm
Weight	Gross/Net: 7,5/7 kg/pc. 2 pcs/cart. 0,37 cbm/cart
Seat and back	Laminated plywood with oak veneer
Frame	Solid oak



FREYA TWO

Item No.	Product	Without Upholstery	A	B	C	1	2
MO 4710	Seat and back in oak	6.470					
MO 4710	Back in oak, seat upholstered		7.400	7.745	8.195	8.470	8.920
MO 4710	Fully upholstered seat and front side upholstered back		8.310	9.225	10.345	11.035	12.185

ADDITIONAL PURCHASE

Item No.	Product	Price
	Frame, seat and back in black-stained oak	835
	Two buttons in front side upholstered back - same fabric as the back	1.285
	Two buttons in front side upholstered back in Savanne leather in selected colours	1.660

ACCESSORIES

Item No.	Product	Price
MO 1617	4 pcs. felt glides, white	185
MO 1638	4 pcs. teflon glides	200
MO 1639	2 built-in castors in front legs	2.000

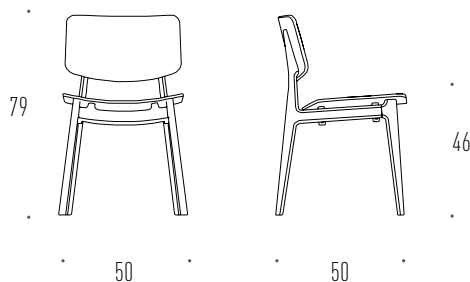

FREYA ARM

DESIGN: (2019) SAYS WHO

SPECIFICATIONS & MEASUREMENTS

Description	Elegant chair with armrest for extra good seating comfort. The chair appears modern with its dynamic design and same profile as Freya and Freya Two.
Measurement	W60 x D58 x H79 x SH46 cm
Weight	Gross/Net: 10/8 kg/pc. 1 pcs/cart. 0,37 cbm/cart
Seat and back	Laminated plywood with oak veneer
Frame	Solid oak
Stackable	6 pcs. Measurement: B60 x D80 x H111 cm



FREYA ARM CHAIR

Item No.	Product	Without upholstery	A	B	C	1	2
MO 4714	Seat and back in oak	11.645					
MO 4714	Back in oak, seat upholstered		12.575	12.910	13.370	13.635	14.095
MO 4714	Fully upholstered seat and front side upholstered back		13.485	14.400	15.520	16.200	17.360

ADDITIONAL PURCHASE

Item No.	Product	Prize
	Frame, seat and back in black-stained oak	835
	Two buttons in front side upholstered back - same fabric as the back	1.285
	Two buttons in front side upholstered back in Savanne leather in selected colours	1.660

ACCESSORIES

Item No.	Product	Prize
MO 1617	4 pcs. felt glides, white	185
MO 1638	4 pcs. teflon glides	200
MO 1639	2 built-in castors in front legs	2.000

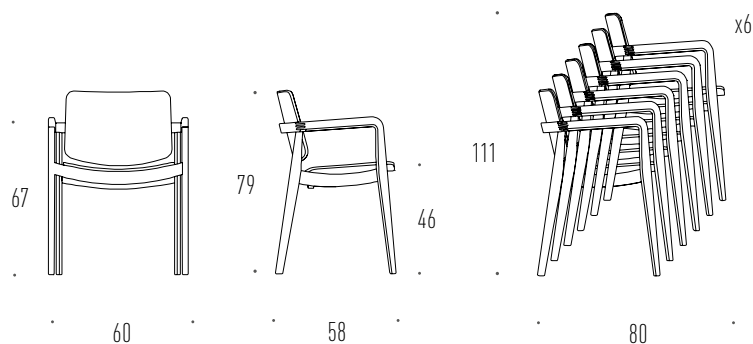

FREYA LOUNGE

DESIGN: (2017) SAYS WHO

SPECIFICATIONS & MEASUREMENTS

Description	Its lower height and wide seat combined with the lounge slope gives the chair great seating comfort.
Measurement	W60 x D62 x H72 x SH43 cm
Weight	Gross/Net: 11/9 kg/pc. 1pcs/cart. 0.35/ cbm/cart
Seat and back	Laminated plywood with oak veneer
Frame	Solid oak



FREYA LOUNGE

Item No.	Product	Without upholstery	A	B	C	1	2
MO 4731	Chair in oak	12.835					
MO 4731	Seat and back with linoleum	16.360					
MO 4731	Seat upholstered		13.985	14.545	15.285	15.750	16.520
MO 4731	Fully upholstered seat and front side upholstered back		15.245	16.360	17.695	18.525	19.870

ADDITIONAL PURCHASE

Item No.	Product	Price
	Black-stained frame, seat and back	835
	Black-stained frame, back and upholstered seat	585
	Back in oak with linoleum, upholstered seat, and frame in oak	1.770
	Back in black-stained oak with linoleum, upholstered seat, and frame in black-stained oak	1.770
	1 stitching in the back	1.170

ACCESSORIES

Item No.	Product	Price
MO 1617	4 pcs. felt glides, white	185
MO 1638	4 pcs. teflon glides	200

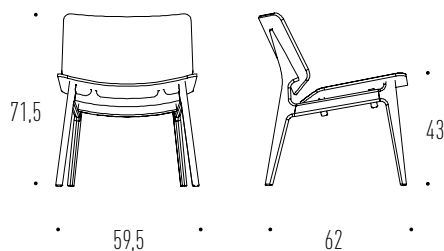

FREYA BENCH

DESIGN: (2019) SAYS WHO

SPECIFICATIONS & MEASUREMENTS

Description	Multi-purpose seating solution. An elegant supplement to any lounge area or alongside the dining table.
Measurement	W175 x D37,5 x H46 cm
Weight	Gross/Net: 1 pcs/cart. 0,35 cbm/cart
Seat	Wooden seat with beveled edge - solid oak, surface treated, or with linoleum, or fully upholstered seat
Frame	Solid oak



FREYA BENCH

Item No.	Product	Without upholstery	A	B	C	1	2
MO 4740	Seat in oak	15.945					
MO 4740	Seat in oak with linoleum, edge laquered or soap treatment	17.420					
MO 4740	Upholstered seat		19.360	21.360	23.500	24.370	31.485

ADDITIONAL PURCHASE

Item No.	Product	Price
	Black-stained oak	835

ACCESSORIES

Item No.	Product	Price
MO 1617	4 pcs. felt glides, white	185
MO 1638	4 pcs. teflon glides	200

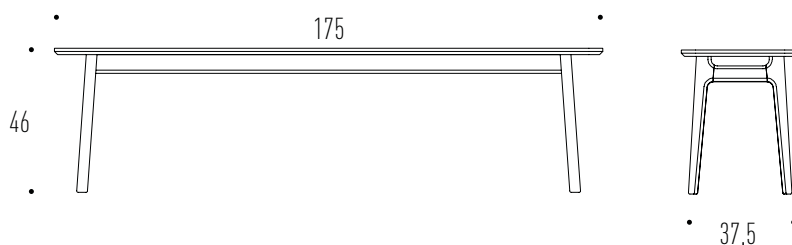

FREYA DESK

DESIGN: (2020) SAYS WHO

SPECIFICATIONS & MEASUREMENTS

Description	With its sleek shape and delicate size, the Freya desk is ideal for the workplace even in a small room.
Table height	74 cm
Table top thickness	25 mm
Table top	Beveled edge - solid oak, surface treated, or with linoleum or laminate
Frame and drawer	Solid oak



FREYA DESK

Item No.	Size	Product	Price
MO 4760-1	110 x 45 cm	Frame, drawer, and table top in solid oak	11.995
MO 4760-2	120 x 60	Frame, drawer, and table top in solid oak	14.750

ADDITIONAL PURCHASE

Item No.	Product	Price
	Table top with surface in laminate or linoleum, edge laquered or soap treatment	1.250
	Frame and table top in black-stained solid oak	1.250
	Table edge, frame and top in black stain with linoleum surface	1.910



FREYA COFFEE TABLE

DESIGN: (2019) SAYS WHO

SPECIFICATIONS & MEASUREMENTS

Description	Rooted in classic Danish furniture design, the Freya Coffee Table series appears modern with its dynamic lines and clean profiles.
Table top thickness	25 mm
Table top	Beveled edge - solid oak, surface treated, or with linoleum or laminate
Frame	Solid oak



FREYA COFFEE TABLE

Item No.	Size	Product	Price
MO 4770-1	Ø40 x H50 cm	Solid oak	5.995
MO 4770-2	Ø60 x H45 cm	Solid oak	7.685
MO 4770-3	Ø85 x H45 cm	Solid oak	11.375
MO 4770-4	120 x 60 x H50 cm	Solid oak	11.375

ADDITIONAL PURCHASE

Item No.	Product	Price
	Table top with surface in laminate or linoleum, edge laquered or soap treatment	1.250
	Frame and table top in black-stained solid oak	1.250
	Black stain of edge and frame of table with linoleum	1.910

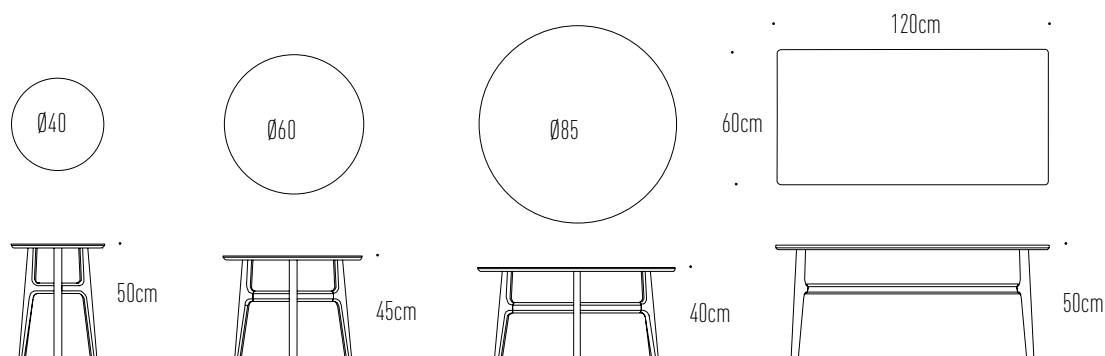

FREYA DINING TABLE

DESIGN: (2019) SAYS WHO

SPECIFICATIONS & MEASUREMENTS

Description	Modern table with synchronic extension mechanism that is easily expanded with a simple movement. The two extension leaves makes the table sit up to 12 people.
Table top tickness	25 mm
Table top	Beveled edge - solid wood, surface treated, or with linoleum or laminate
Extension leaf	Same treatment as the table top
Frame	Solid wood



FREYA DINING TABLE

Item No.	Size	Product	Price
MO 4780	210 x 95 cm	Frame and table top in oak	32.660

FREYA DINING EXTENSION LEAF

Item No.	Size	Product	Price
MO 4789	95 x 48 cm	Extension leaf in solid oak	5.150
MO 4789	95 x 48 cm	Extension leaf with linoleum and oak edge	5.520
MO 4789	95 x 48 cm	Extension leaf in black MDF, lacquered	3.200
MO 4789	95 x 48 cm	Extension leaf in black-stained oak	5.400

ADDITIONAL PURCHASE

Item No.	Product	Price
	Table top with surface in linoleum	1.670
	Frame and table top in black-stained oak	1.585
	Black stain of edge and frame of table with table top with surface in linoleum	1.910

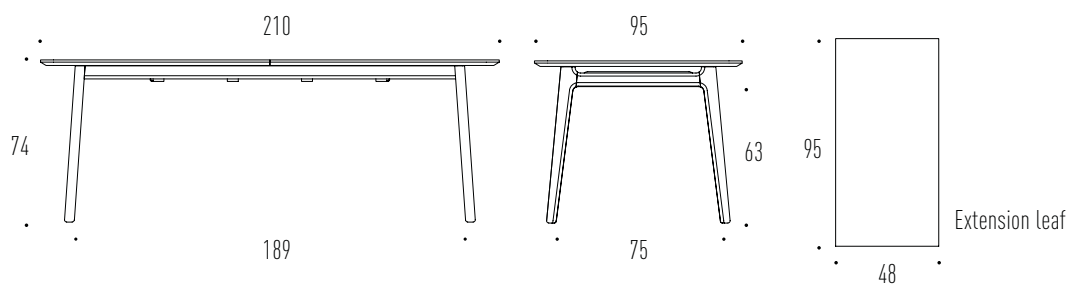

BUTTERFLY SERIES

DESIGN: NIELS GAMMELGAARD

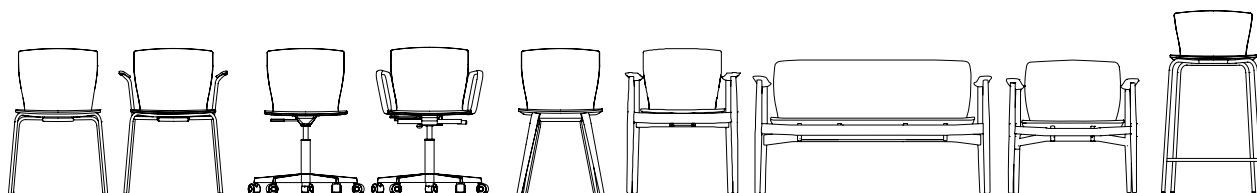

The Butterfly Series consists of 9 variants that offer a multitude of combinations with different kind of frames, wooden surfaces, and fabric variants. The chairs have a high seating comfort and elegant lightweight, yet distinctive and slim design. The seat shape and ease of the design resemble a butterfly, hence the name of these designer chairs.

WOOD & TREATMENTS

See product details on the individual product pages



Oak,
transparent
lacquer

Oak, black-
stained

STEEL & ALUMINUM COLOURS



Steel, bright
chrome

Steel, powder
lacquered in
matt, black
grained
lacquer

Polished
aluminium

Aluminium in
matt, black
grained lacquer

RECOMMENDED FABRIC, LEATHER & ARTIFICIAL LEATHER

GROUP A	GROUP B	GROUP C	LEATHER 1	LEATHER 2
Cura, Main Line Plus	Haku, Illusion, Remix 3	Hallingdal 65, Steelcut Trio 3	Sydney, Hero	Savanne

See the overview of fabric, leather and artificial leather on page 89

CERTIFICATIONS



EU Ecolabel: DK/049/016

EU Ecolabel certification on specific products:

Butterfly Bar Chair (5314 + 5315)
Butterfly Wood (5340)
Butterfly Classic Chair (5351)
Butterfly Classic Lounge (5369/5379)
Butterfly (5310)

BUTTERFLY WITH 4 STEEL LEGS

DESIGN: (2013) NIELS GAMMELGAARD

SPECIFICATIONS & MEASUREMENTS

Description	Stackable chair with lumbar support and flexibility in the back.
Measurement	W53 x D53 x H79 x SH46 cm
Weight	Gross/Net: 6/5 kg/pc. 4 pcs/cart. 0,375 cbm/cart
Seat and back	Laminated plywood with oak veneer or black-stained or upholstery, fully or partially
Frame	Tubular steel - bright chrome or powder lacquered in matt, black grained lacquer
Stackable	Without upholstery: Floor: 12 pcs. Trolley: 20 pcs. With upholstery: Floor: 10 pcs. Trolley: 12-15 pcs. W55 x D95 x H130 cm (with 12 pcs.)



BUTTERFLY WITH 4 STEEL LEGS

Item No.	Product	Without upholstery	A	B	C	1	2
MO 5310	Chair in oak	4.185					
MO 5310	Upholstered seat		5.495	5.885	6.370	6.675	7.510
MO 5310	Fully upholstered		7.210	8.175	9.385	10.150	11.925
MO 5310	Front side upholstered		7.570	8.585	9.850	10.660	12.525

ADDITIONAL PURCHASE

Item No.	Product	Price
	Chair in black-stained oak	835
	Channel stitchings, fully upholstered model	2.200
	Channel stitchings, front side upholstered model	3.245

ACCESSORIES

Item No.	Product	Price
MO 1306	Hang-up bracket - single, in black plastic. Min. table length: 2 chairs 140 cm and 3 chairs 200 cm	460
MO 1154	Trolley - Chairs without upholstery: 20 pcs. Chairs with upholstery: 12-15 pcs.	19.625
MO 1213	Linking device - device: 9 cm	835
MO 1600	4 pcs. Loose, hard plastic glides, black (for soft floors)	160
MO 1601	4 pcs. Loose, less hard plastic glides, grey (for soft)	160
MO 1602	4 pcs. loose felt glides	185

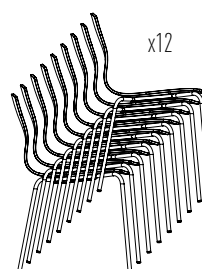
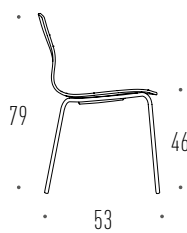
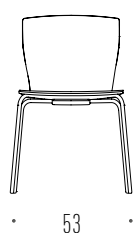

BUTTERFLY WITH 4 STEEL LEGS & ARMREST

DESIGN: (2013) NIELS GAMMELGAARD

SPECIFICATIONS & MEASUREMENTS

Description	Stackable chair with armrest and lumbar support and flexibility in the back.
Measurement	W53 x D53 x H79 x SH46 cm
Weight	Gross/Net: 6/5 kg/pc. 4 pcs/cart. 0,375 cbm/cart
Seat and back	Laminated plywood with oak veneer or black-stained or upholstery, fully or partially
Frame	Tubular steel: bright chrome or powder lacquered in matt, black grained lacquer Black PUR rubber - wooden armrests available at an additional price
Armrest	Without upholstery: Floor: 12 pcs. Trolley: 20 pcs.
Stackable	With upholstery: Floor: 10 pcs. Trolley: 12-15 pcs. Measurement with 12 pcs. W60 x D95 x H120 cm



BUTTERFLY WITH 4 STEEL LEGS AND ARMREST

Item No.	Product	Without upholstery	A	B	C	1	2
MO 5311	Chair in oak	5.375					
MO 5311	Upholstered seat		6.635	7.025	7.520	7.820	8.700
MO 5311	Fully upholstered		8.325	9.320	10.525	11.475	13.120
MO 5311	Front side upholstered		8.770	9.785	9.220	11.860	13.775

ADDITIONAL PURCHASE

Item No.	Product	Price
	Chair in black-stained oak	835
	Armrest in wood, laquered or black-stained	420
	Channel stitchings, fully upholstered model	2.200
	Channel stitchings, front side upholstered model	3.245

ACCESSORIES

Item No.	Product	Price
MO 1306	Hang-up bracket- single, in black plastic. Min. table length: 2 chairs 140 cm and 3 chairs 200 cm	460
MO 1154	Trolley - Chairs without upholstery: 20 pcs. Chairs with upholstery: 10 pcs.	19.625
MO 1213	Linking device - device: 9 cm	835
MO 1600	4 pcs. Loose, hard plastic glides, black (for soft floors)	160
MO 1601	4 pcs. Loose, less hard plastic glides, grey (for soft)	160
MO 1602	4 pcs. loose felt glides	185

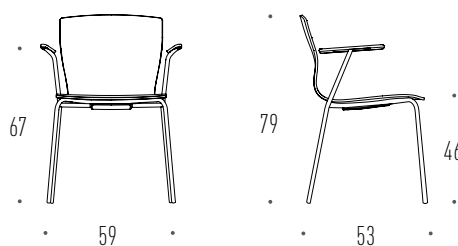

BUTTERFLY SWIVEL

DESIGN: NIELS GAMMELGAARD

SPECIFICATIONS & MEASUREMENTS

Description	Functional office chair without compromising on design.
Measurement	W64 x D55 x H77-95 x SH44-58 cm
Weight	Gross/Net: 13,9/11,9 kg/pc. 2 pcs/cart. 0,43 kbm kart.
Seat and back	Laminated plywood with oak veneer with upholstery
Frame	Polished aluminium and aluminium in matt, black grained lacquer
Model MO 5480	Castors, flexible tilt, height adjustment
Model MO 5482	Glides, flexible tilt, revolving, self centering
Model MO 5484	Glides, flexible tilt, height adjustment



BUTTERFLY SWIVEL

Item No.	Product	A	B	C	1	2
MO 5480, 5482, 5484	Fully upholstered	9.050	10.060	11.295	12.085	13.985
MO 5480, 5482, 5484	Front side upholstered	9.500	10.560	11.860	12.695	14.685

ADDITIONAL PURCHASE

Item No.	Product	Price
	Glides with felt	370
	Hard castors	370
	Frame and armrest in black, grained lacquer	585
	Narrow channel stitchings, fully upholstered version	2.200
	Narrow channel stitchings, front side upholstered version	3.245

ACCESSORIES

Item No.	Product	Price
MO 1306	Hang-up bracket- single, in black plastic. Min. table length: 2 chairs 140 cm and 3 chairs 200 cm	420
MO 1507	Writing tablet - tablet in plywood with white laminat, edge painted black. Steel arm in black lacquer. Rotateable, fixed on column	3.660
MO 1608	1 set (5 pcs.) plastic glides, hard (for soft floors)	1.160
MO 1609	1 set (5 pcs.) plastic glides with felt (for hard floors)	1.160
MO 1611	1 set (5 pcs.) soft castors (for hard floors)	1.160
MO 1622	1 set (5 pcs.) hard castors (for soft floors)	1.160

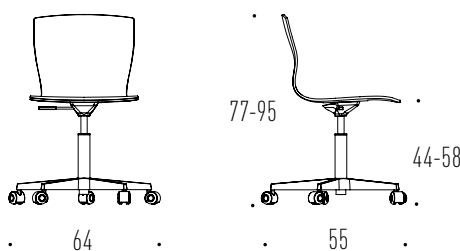

BUTTERFLY SWIVEL WITH ARMREST

DESIGN: (2013) NIELS GAMMELGAARD

SPECIFICATIONS & MEASUREMENTS

Description	Functional office chair without compromising on design.
Measurement	W64 x D55 x H77-95 x SH44-58 cm
Weight	Gross/Net: 13,9/11,9 kg/pc. 1 pcs/cart. 0,35 kbm kart.
Seat and back	Laminated plywood with oak veneer with upholstery
Frame and armrests	Polished aluminium and aluminium in matt, black grained lacquer
Model MO 5481	Castors, flexible tilt, height adjustment
Model MO 5483	Glides, flexible tilt, revolving, self centering
Model MO 5485	Glides, flexible tilt, height adjustment



BUTTERFLY SWIVEL WITH ARMREST

Item No.	Product	A	B	C	1	2
MO 5481, 5483, 5485	Fully upholstered	11.935	12.945	14.175	14.970	16.870
MO 5481, 5483, 5485	Front side upholstered	12.385	13.445	14.745	15.575	17.570

ADDITIONAL PURCHASE

Item No.	Product	Price
	Glides with felt	370
	Hard castors	370
	Frame and armrest in black, grained lacquer	585
	Narrow channel stitchings, fully upholstered version	2.200
	Narrow channel stitchings, front side upholstered version	3.245

ACCESSORIES

Item No.	Product	Price
MO 1608	1 set (5 pcs.) plastic glides, hard (for soft floors)	1.160
MO 1609	1 set (5 pcs.) plastic glides with felt (for hard floors)	1.160
MO 1611	1 set (5 pcs.) soft castors (for hard floors)	1.160
MO 1622	1 set (5 pcs.) hard castors (for soft floors)	1.160

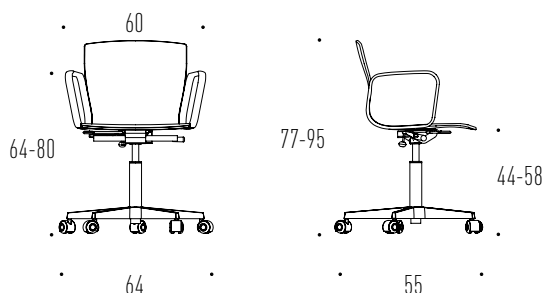

BUTTERFLY SWIVEL HIGH

DESIGN: (2016) NIELS GAMMELGAARD

SPECIFICATIONS & MEASUREMENTS

Description	Functional office chair without compromising on design.
Measurement	W64 x D55 x H85-103 x SH44-58 cm
Weight	Gross/Net: 13,5/11,5 kg/pc. 2 pcs/cart. 0,43 cbm/cart
Seat and back	Laminated plywood with oak veneer with upholstery
Frame	Polished aluminium and aluminium in matt, black grained lacquer
Model MO 5490	Castors, flexible tilt, height adjustment
Model MO 5492	Glides, flexible tilt, revolving, self centering
Model MO 5494	Glides, flexible tilt, height adjustment



BUTTERFLY SWIVEL HIGH

Item No.	Product	A	B	C	1	2
MO 5490, 5492, 5494	Fully upholstered	10.425	11.595	13.020	13.925	16.835
MO 5490, 5492, 5495	Front side upholstered	10.950	12.175	13.670	14.625	17.675

ADDITIONAL PURCHASE

Item No.	Product	Price
	Glides with felt	370
	Hard castors	370
	Frame and armrest in black, grained lacquer	585
	Wide channel stitchings, fully upholstered version	2.200
	Wide channel stitchings, front side upholstered version	3.245

ACCESSORIES

Item No.	Product	Price
MO 1306	Hang-up bracket- single, in black plastic. Min. table length: 2 chairs 140 cm and 3 chairs 200 cm	420
MO 1507	Writing tablet - tablet in plywood with white laminat, edge painted black. Steel arm in black lacquer. Rotateable, fixed on column	3.660
MO 1608	1 set (5 pcs.) plastic glides, hard (for soft floors)	1.160
MO 1609	1 set (5 pcs.) plastic glides with felt (for hard floors)	1.160
MO 1611	1 set (5 pcs.) soft castors (for hard floors)	1.160
MO 1622	1 set (5 pcs.) hard castors (for soft floors)	1.160

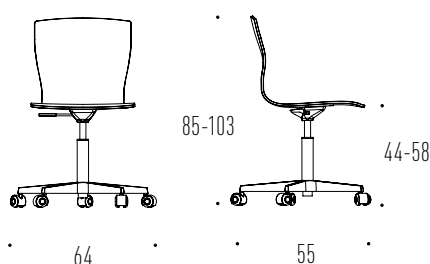

BUTTERFLY SWIVEL HIGH WITH ARM

DESIGN: (2016) NIELS GAMMELGAARD

SPECIFICATIONS & MEASUREMENTS

Description	Functional office chair without compromising on design.
Measurement	W64 x D55 x H85-103 x SH44-58 cm
Weight	Gross/Net: 14,1/12,1 kg/pc. 1 pcs/cart. 0,35 cbm/cart
Seat and back	Laminated plywood with oak veneer with upholstery
Frame and armrests	Polished aluminium and aluminium in matt, black grained lacquer
Model MO 5491	Castors, flexible tilt, height adjustment
Model MO 5493	Glides, flexible tilt, revolving, self centering
Model MO 5495	Glides, flexible tilt, height adjustment



BUTTERFLY SWIVEL HIGH WITH ARMREST

Item No.	Product	A	B	C	1	2
MO 5491, 5493, 5495	Fully upholstered	13.310	14.475	15.900	16.810	19.720
MO 5491, 5493, 5495	Front side upholstered	13.835	15.060	16.550	17.510	20.560

ADDITIONAL PURCHASE

Item No.	Product	Price
	Glides with felt	370
	Hard castors	370
	Frame and armrest in black, grained lacquer	585
	Wide channel stitchings, fully upholstered version	2.200
	Wide channel stitchings, front side upholstered version	3.245

ACCESSORIES

Item No.	Product	Price
MO 1608	1 set (5 pcs.) plastic glides, hard (for soft floors)	1.160
MO 1609	1 set (5 pcs.) plastic glides with felt (for hard floors)	1.160
MO 1611	1 set (5 pcs.) soft castors (for hard floors)	1.160
MO 1622	1 set (5 pcs.) hard castors (for soft floors)	1.160

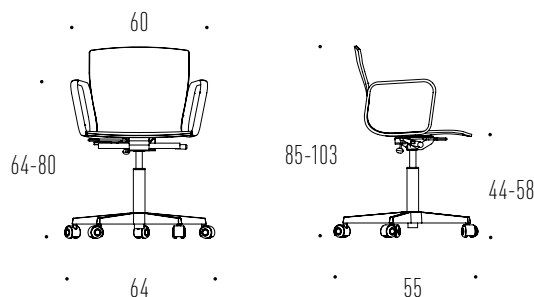

BUTTERFLY WOOD

DESIGN: (2013) NIELS GAMMELGAARD

SPECIFICATIONS & MEASUREMENTS

Description	Chair in Nordic design tradition with laminated wood shell and wood frame in Scandinavian oak.
Measurement	W46 x D52 x H79 x SH46 cm
Weight	Gross/Net: 5,4/4,9 kg/pc. 2 pcs/cart. 0,32 cbm/cart
Seat and back	Laminated plywood with oak veneer with transparent lacquer or black-stained or upholstery, fully or partially
Frame	Laminated wood with top veneer in oak with transparent lacquer or black-stained



BUTTERFLY WOOD

Item No.	Product	Without Upholstery	A	B	C	1	2
MO 5340	Chair in oak	4.995					
MO 5340	Upholstered seat		6.325	6.620	7.010	7.270	7.645
MO 5340	Fully upholstered		7.675	8.470	9.425	10.035	11.025
MO 5340	Front side upholstered		8.075	8.910	9.910	10.550	11.585

ADDITIONAL PURCHASE

Item No.	Product	Price
	Chair in black-stained oak	835
	Frame in black-stained oak	585
	Narrow channel stitchings, fully upholstered version	2.200
	Narrow channel stitchings, front side upholstered version	3.245

ACCESSORIES

Item No.	Product	Price
MO 1306	Hang-up bracket- single, in black plastic. Min. table length: 2 chairs 140 cm and 3 chairs 200 cm	395
MO 1612	4 pcs. loose felt glides, white	185
MO 1613	4 pcs. loose plastic glides, white	200

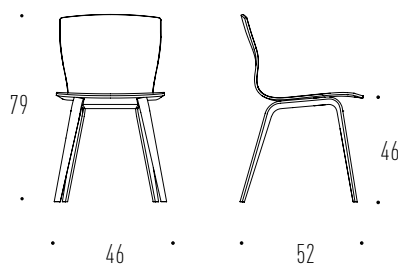

BUTTERFLY CLASSIC ARMCHAIR

DESIGN: (2018) NIELS GAMMELGAARD

SPECIFICATIONS & MEASUREMENTS

- Description** Exclusive and comfortable solution for dining tables as well as meeting tables, but also functions as an independent chair in classic design surroundings.
- Measurement** W63 x D52 x H80 x SH46 cm
- Weight** Gross/Net: 6,5/4,9 kg/pc. 1 pcs/cart. 0,33 cbm/cart
- Seat and back** Laminated plywood with oak veneer or black-stained or upholstery, fully or partially
- Frame and armrest** Solid wood with transparent lacquer or black-stained



BUTTERFLY CLASSIC ARMCHAIR

Item No.	Product	Without upholstery	A	B	C	1	2
MO 5351	Chair in oak	7.625					
MO 5351	Fully upholstered		10.650	11.625	12.825	13.595	15.960
MO 5351	Front side upholstered		11.010	12.035	13.295	14.100	16.495

ADDITIONAL PURCHASE

Item No.	Product	Price
	Chair in black-stained oak	835
	Frame and armrest in black-stained oak	585

ACCESSORIES

Item No.	Product	Price
MO 1617	4 pcs. felt glides, white	185
MO 1638	4 pcs. teflon glides	200
MO 1640	2 pcs. front castors	2.000

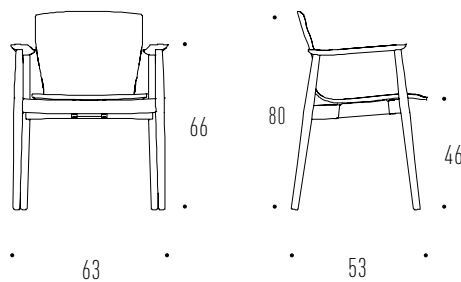

BUTTERFLY CLASSIC LOUNGE

DESIGN: (2018) NIELS GAMMELGAARD

SPECIFICATIONS & MEASUREMENTS

Description	The low height and the wide seat give the chair exceptional comfort combined with the simple, beautiful design.
Measurement	W73 x D63 x H73/75 x SH39/43 cm
Weight	Gross/Net: 16/14 kg/pc. 1 pcs/cart. 0.45 cbm/cart
Model MO 5369	Seat height: H73 x SH39 cm
Model MO 5379	Seat height: H75 x SH43 cm
Seat and back	Laminated plywood with oak veneer or black-stained or upholstery, fully or partially
Frame and armrest	Solid wood with transparent lacquer or black-stained



BUTTERFLY CLASSIC LOUNGE

Item No.	Product	Without upholstery	A	B	C	1	2
MO 5369, MO 5379	Chair in oak	16.660					
MO 5369, MO 5379	Fully upholstered		19.810	21.770	24.135	25.645	28.075
MO 5369, MO 5379	Front side upholstered		20.800	22.860	25.345	26.925	29.475

ADDITIONAL PURCHASE

Item No.	Product	Price
	Chair in black-stained oak	835
	Frame and armrest in black-stained oak	585

ACCESSORIES

Item No.	Product	Price
MO 1617	4 pcs. felt glides, white	185
MO 1638	4 pcs. teflon glides	200

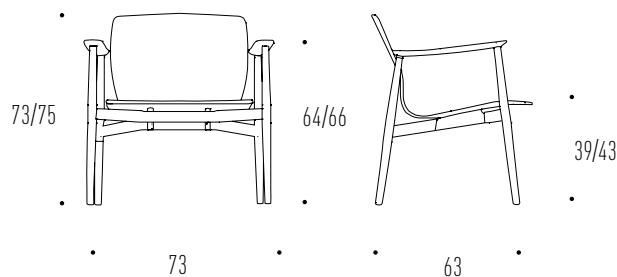

BUTTERFLY CLASSIC 2-SEATER

DESIGN: (2018) NIELS GAMMELGAARD

SPECIFICATIONS & MEASUREMENTS

Description	A lounge 2-seater in a simple and slim design expression with extraordinary seating comfort.
Measurement	B131 x D63 x H73/75 x SH39/43 cm
Weight	Gross/Net: 20/18 kg/pc. 1 pcs/cart. 0,75 cbm/cart
Model MO 5381	Seat height: H73 x SH39 cm
Model MO 5391	Seat height: H75 x SH43 cm
Seat and back	Laminated plywood with fully upholstery
Frame and armrest	Solid wood with transparent lacquer or black-stained



BUTTERFLY CLASSIC 2-SEATER

Item No.	Product	A	B	C	1	2
MO 5381, MO 5391	Fully upholstered	37.000	39.550	42.585	44.495	47.570

ADDITIONAL PURCHASE

Item No.	Product	Price
	Frame in black-stained oak	1.250

ACCESSORIES

Item No.	Product	Price
MO 1617	4 pcs. felt glides, white	185
MO 1638	4 pcs. teflon glides	200

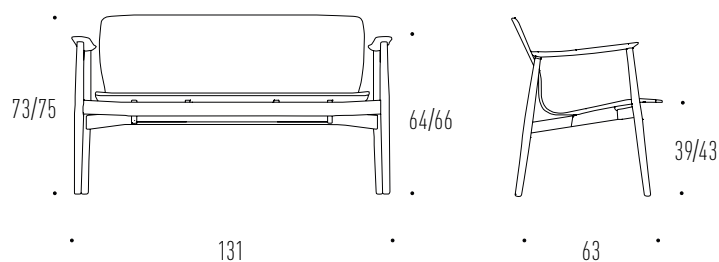

BUTTERFLY BAR

DESIGN: (2013) NIELS GAMMELGAARD

SPECIFICATIONS & MEASUREMENTS

Description	Stackable bar chair with lumbar support and flexibility in the back.
Measurement	W49 x D53 x H87/99 x SH65/77cm
Weight	Gross/Net: 6/5 kg/pc. 2 pcs/cart. 0,29 cbm/cart
Seat height	MO 5318: H87 x SH65 cm MO 5319: H99 x SH77 cm
Seat and back	Laminated plywood with oak veneer or black-stained or upholstery, fully or partially
Frame	Tubular steel - bright chrome or powder lacquered in matt, black grained lacquer
Stackable	6 pcs.



BUTTERFLY BAR

Item No.	Product	Without upholstery	A	B	C	1	2
MO 5318, MO 5319	Chair in oak	5.550					
MO 5318, MO 5319	Fully upholstered		8.760	9.735	10.945	11.710	12.935
MO 5318, MO 5319	Front side upholstered		9.225	10.245	11.510	12.320	12.375

ADDITIONAL PURCHASE

Item No.	Product	Price
	Chair in black-stained oak	1.050

ACCESSORIES

Item No.	Product	Price
MO 1600	4 pcs. Loose, hard plastic glides, black (for soft floors)	75
MO 1601	4 pcs. Loose, less hard plastic glides, grey (for soft	75
MO 1602	4 pcs. loose felt glides	185
MO 1306	Hang-up bracket- single, in black plastic.	395

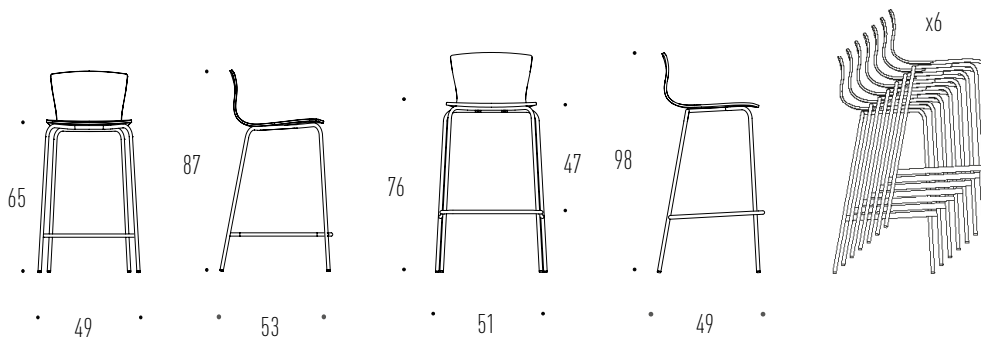

MODEL 107 SERIES

DESIGN: (1950) IB KOFOD-LARSEN

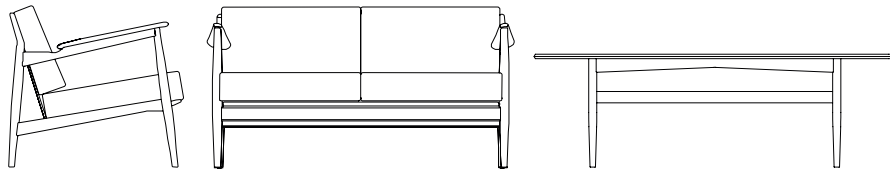

Model 107 was designed in the 1950s and originally produced by Magnus Olesen in 1956. Paying respect to the original design and craftsmanship, the series is being relaunched in a classic version in oak, teak, leather and wool. The design is refreshed by additional coloured option in grey speaking to the modern design lover.

WOOD & TREATMENTS

See product details on the individual product pages

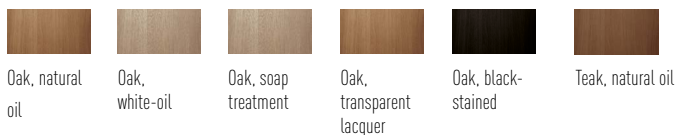

PAINTED BEECH



beech, painted grey
NCS S3000-N

RECOMMENDED FABRIC, LEATHER & ARTIFICIAL LEATHER

GROUP A	GROUP B	GROUP C	LEATHER 1	LEATHER 2
	Main Line Flax, Synergy, Remix 3	Steel Trio, Hallingdal 65,	Hero, Sydney	Savanne, Dunes, Vacona

See the overview of fabric, leather and artificial leather on page 89

MODEL 107 LOUNGE CHAIR

DESIGN: (1950) IB KOFOD-LARSEN

SPECIFICATIONS & MEASUREMENTS

Description A comfortable lounge chair designed in the 50s - with details that reflect the original, classic design from the Danish Modern era.

Measurement W71 x D74 x H68 x SH40 cm

Weight Gross/Net: 19/18 kg/pc. 1 pcs/cart. 0,590 cbm/cart

Cushions Fully upholstered reversible cushions for seat and back

Frame and armrest Solid oak, teak or painted beech



MODEL 107

Item No.	Product	A	B	C	1	2
MO 107	Frame and armrest in painted beech (Grey)	22.800	25.235	28.125	29.935	32.870
MO 107	Frame and armrest in oak	27.370	29.800	32.695	34.500	37.435
MO 107	Frame in oak and armrest in oiled teak	30.775	33.200	36.100	37.910	40.850
MO 107	Frame and armrest in oiled teak	50.200	52.625	55.520	57.335	60.270

ADDITIONAL PURCHASE

Item No.	Product	Price
	6 buttons in the back - same fabric as the chair	1.710
	6 buttons in the back selected colours in Savanne leather	2.400

ACCESSORIES

Item No.	Product	Price
MO 1617	4 pcs. Felt glides, white	185
MO 1638	4 pcs. Teflon glides	200

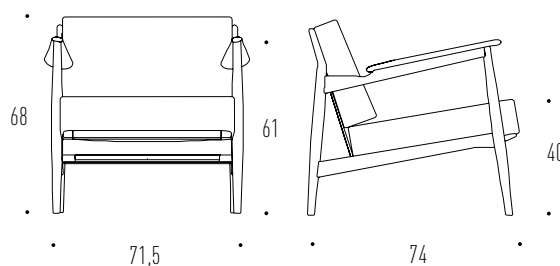

MODEL 107 2-SEATER

DESIGN: (1950) IB KOFOD-LARSEN

SPECIFICATIONS & MEASUREMENTS

Description A comfortable lounge 2-seater designed in the 50s - with details that reflect the original, classic design from the Danish Modern era.

Measurement W131 x D74 x H68 x SH40 cm

Weight Gross/Net: 37/36 kg/pc. 1 pcs/cart. 1,180 cbm/cart

Cushions Fully upholstered reversible cushions for seat and back

Frame and armrest Solid oak, teak or painted beech



MODEL 107S

Item No.	Product	A	B	C	1	2
MO 107S	Frame and armrest in oak	46.325	51.195	56.960	60.595	66.450
MO 107S	Frame in oak and armrest in oiled teak	49.745	54.610	60.375	64.010	68.775
MO 107S	Frame and armrest in oiled teak	116.660	133.195	127.185	130.810	136.670

ADDITIONAL PURCHASE

Item No.	Product	Price
	12 buttons in the back - same fabric as the chair	3.425
	12 buttons in the back selected colours in Savanne leather	4.795

ACCESSORIES

Item No.	Product	Price
MO 1617	4 pcs. Felt glides, white	185
MO 1638	4 pcs. Teflon glides	200

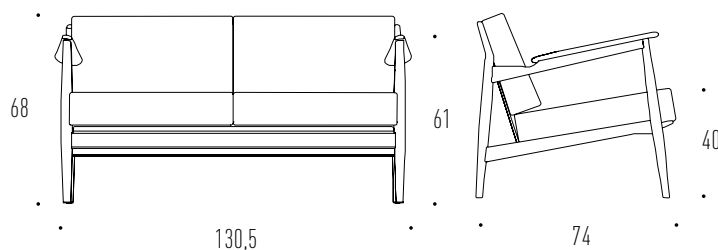

MODEL 107 COFFEE TABLE

DESIGN: (1950) IB KOFOD-LARSEN

SPECIFICATIONS & MEASUREMENTS

Description	Designed in the 50s in the same style as the rest of the Model 107 series.
Measurement	W120 x D56 x H50 cm
Table top	Surface in oak or teak with solid edge in oak or teak
Frame	Solid oak



MODEL 107T

Item No.	Product	Price
M0107T-L2	Frame in oak (oiled, white-oiled, or soap treated oak) and table top in oak veneer with solid oak edge (same treatment as frame)	21.450
M0107T-L1	Frame in oak (white-oiled) and table top in teak veneer with solid teak edge, oiled	22.575
M0107T-L4	Frame in oak (black-stained) and table top in teak veneer with solid teak edge, oiled	22.700
M0107T-L5	Frame in oak (oiled) and table top in teak veneer with solid teak edge, oiled	22.575

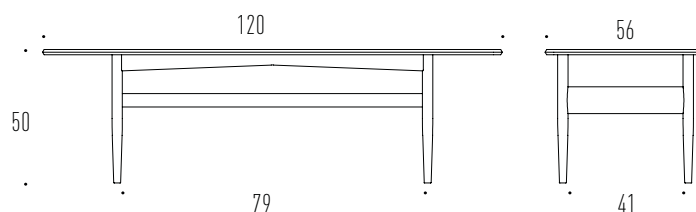

XYLOFON SERIES

DESIGN: (1997) NIELS JØRGEN HAUGESEN

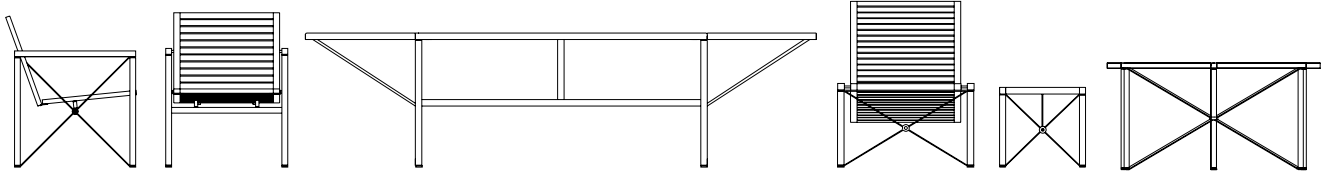

The Xylofon series is a range of outdoor furniture. The combination of steel and wood conveys a feeling of both lightness and strength in a simple and logic design - a design method Niels Jørgen Haugesen was known for. Xylofon is a classic design that gets even more beautiful with time. The series is in teak wood, either oil treated or untreated.

WOOD & TREATMENTS

See product details on the individual product pages



Teak, oiled



Teak, untreated

STEEL COLOURS



Hot-dip galvanized steel
for outdoor use

CUSHION



468 Black



415 White-beige

XYLOFON SEATING

DESIGN: (1997) NIELS JØRGEN HAUGESEN

SPECIFICATIONS & MEASUREMENTS

Description The combination of steel and wood conveys a feeling of both lightness and strength. A classic design that gets even more beautiful with time.

NB Contact the factory for information on delivery time for the individual models



XYLOFON ARMCHAIR

Item No.	Size	Price
MO 4661	W59 X D63 X H74 X SH40 cm INFO: Gross/net 12,1/10,8 kg. 2 pcs./carton. 0,136 cbm/carton	9.225

XYLOFON 2-SEATER WITH BACK AND ARMREST

Item No.	Size	Price
MO 4662	W118 X D63 X H74 X SH40 cm INFO: Gross/net 20,9/18,9 kg. 1 pcs./carton. 0,1 cbm/carton	18.020

XYLOFON BENCH

Item No.	Size	Price
MO 4664	L143 X B40 X H40 X SH40 cm INFO: Gross/net 12,5/10,7 kg. 1 pcs./carton. 0,052 cbm/carton	10.670

XYLOFON SUNCHAIR

Item No.	Size	Price
MO 4663	L194 X B65 X H40 X SH40 cm INFO: Gross/net 31,5/28,5 kg. 1 pcs./carton. 0,63 cbm/carton	24.295

XYLOFON CUSHIONS

Item No.	Size	Price
MO 1822	Seat/back cushion for MO 4661 Xylofon armchair (for MO 4662 Xylofon 2-seater 2 of these are used)	2.310
MO 1823	Cushion for MO 4662 Xylofon sunbed	3.550

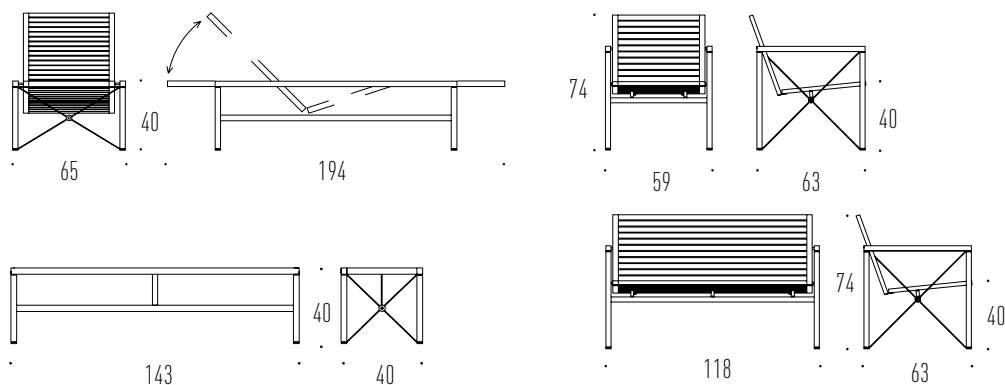

XYLOFON TABLES

DESIGN: (1997) NIELS JØRGEN HAUGESEN

SPECIFICATIONS & MEASUREMENTS

Description The combination of steel and wood conveys a feeling of both lightness and strength. A classic design that gets even more beautiful with time.

Table height 66 cm

NB Contact the factory for information on the delivery time for the individual models



XYLOFON CHAIR WITH 2 DROP LEAVES

Item No.	Size	Price
MO 4671	252 x 85 cm	26.695

XYLOFON TABLE - ROUND

Item No.	Size	Price
MO 4680	Ø 128 CM	27.520

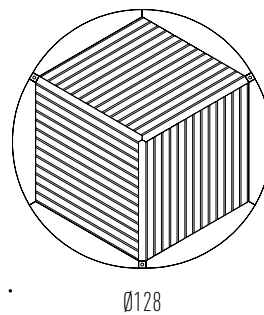
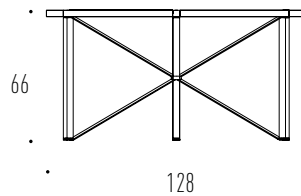
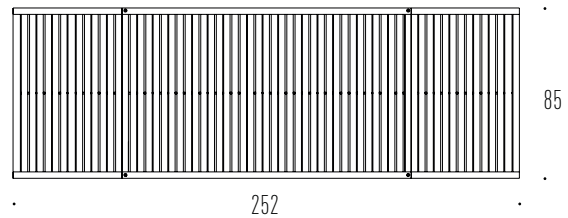
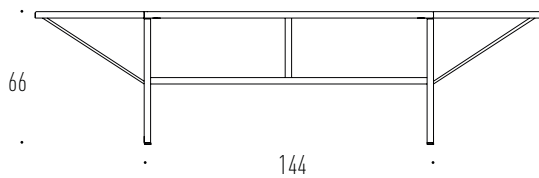

Ø CHAIR

DESIGN: (2020) ØIVIND SLAATTO



A chair in modular design consisting of three parts - seat, back and frame - elegantly combined with just one screw. This makes the chair easy to disassemble, so parts can be recycled and reused. The chair is created under the aspect of unique design, longevity and minimal transport costs due to the chairs stacking ability.

WOOD & TREATMENTS

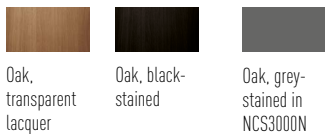

Oak, transparent lacquer

Oak, black-stained

Oak, grey-stained in NCS3000N

SPECIAL COLOURS ON SEAT AND BACK IN OAK

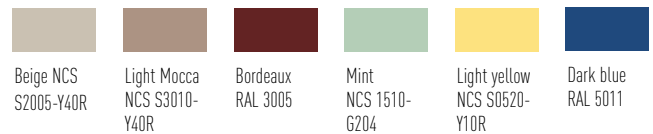

Beige NCS S2005-Y40R

Light Mocca NCS S3010-Y40R

Bordeaux RAL 3005

Mint NCS 1510-G204

Light yellow NCS S0520-Y10R

Dark blue RAL 5011

STANDARD STEEL COLOURS

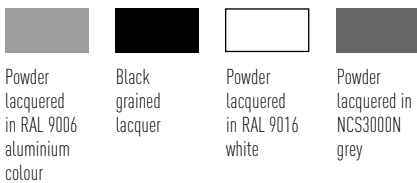

Powder lacquered in RAL 9006 aluminium colour

Black grained lacquer

Powder lacquered in RAL 9016 white

Powder lacquered in NCS3000N grey

SPECIAL STEEL COLOURS



Beige NCS S2005-Y40R

Light Mocca NCS S3010-Y40R

Bordeaux RAL 3005

Mint NCS 1510-G204

STANDARD SCREW COLOURS

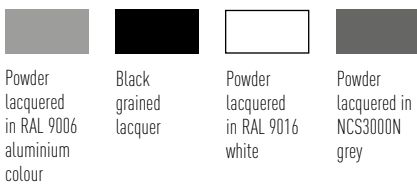

Powder lacquered in RAL 9006 aluminium colour

Black grained lacquer

Powder lacquered in RAL 9016 white

Powder lacquered in NCS3000N grey

SPECIAL SCREW COLOURS



Brass

Bordeaux RAL 3005

Mint NCS 1510-G204

RECOMMENDED FABRIC, LEATHER & ARTIFICIAL LEATHER

GROUP A	GROUP B	GROUP C	LEATHER 1	LEATHER 2
Cura, Era	Atlas, Remix 3, Main Line Flax, Illusion	Steel Trio 3, Hallingdal 65	Hero, Sydney	Savanne, Vacona

See the overview of fabric, leather and artificial leather on page 89

Ø CHAIR - 9 SELECTED VARIANTS

DESIGN: (2020) ØIVIND SLAATTO



Ø CHAIR - 9 SELECTED VARIANTS

Item No.	Product	Description	Price
MO 2030-L1	CLASSIC - Wood/ White/ Grey	Frame: White. Seat: Oak w/transparent lacquer. Screw: Brass. Back: Grey	4.995
MO 2030-L2	CLASSIC - Black Monochrome	Frame: Black grained lacquer. Seat: Oak, painted black. Screw: Black. Back: Oak, painted black	4.950
MO 2030-L3	CLASSIC - Wood/ Wood/ White	Frame: White. Seat: Oak w/transparent lacquer. Screw: White. Back: Oak w/transparent lacquer	4.950
MO 2030-L4	NATURE - Nature/ Leather	Frame: Beige. Seat: Upholstered in leather - Royal Nubuck Ecu 30253. Screw: Brass. Back: Light Mocca	8.185
MO 2030-L5	NATURE - Nature	Frame: Mocca. Seat: Light. Mocca. Screw: Brass. Back: Beige	5.870
MO 2030-L6	COLOURS - Cool Mint	Frame: Bordeaux. Seat: Mint. Screw: Brass. Back: Dark blue	5.870
MO 2030-L7	COLOURS - Cool Mint Fabric	Frame: Mint. Seat: Upholstered - Atlas 911. Screw: Mint. Back: Oak w/transparent lacquer	6.510
MO 2030-L8	COLOURS - Bordeaux Pang	Frame: Bordeaux. Seat: Upholstered - Atlas 661. Screw: Bordeaux. Back: Bordeaux	6.660
MO 2030-L9	COLOURS - Pale Sun	Frame: Grey. Seat: Light yellow. Screw: Grey. Back: Oak w/transparent lacquer	4.950

Ø CHAIR

DESIGN: (2020) ØIVIND SLAATTO

SPECIFICATIONS & MEASUREMENTS

Description A chair in a modular design with only 3 elements - back, seat and legs - assembled elegantly with one screw.

Measurement W50 x D53 x H80 x SH45 cm

Weight Gross/Net: 5,7/4,6 kg/pc. 5 pcs/cart. 0,375 cbm/cart

Stackable Without upholstery: 12 pcs.

With upholstery: 8 pcs.



Ø CHAIR

Item No.	Product	Without upholstery	A	B	C	1	2
MO 2030	Chair in oak with transparent lacquer	4.950					
MO 2030	Seat upholstered - with visible screw		5.785	6.485	7.410	7.960	8.850

ADDITIONAL PURCHASE

Item No.	Product	Price
	Frame colour - see page 40	185
	Seat screw colour - see page 40	185
	Seat and back colour - see page 40	185

*Available in selected special colors - when purchasing a minimum of 25 pcs. in the same color

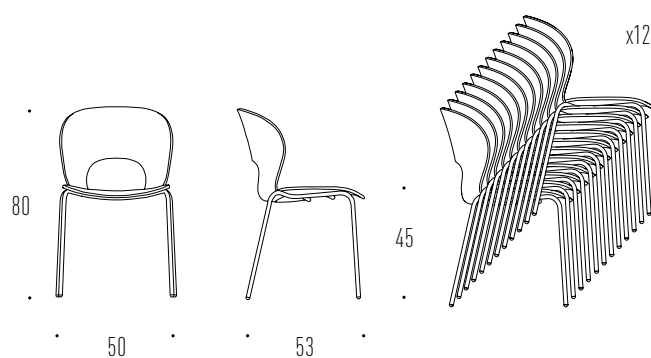

PAUSE

DESIGN: BUSK + HERTZOG

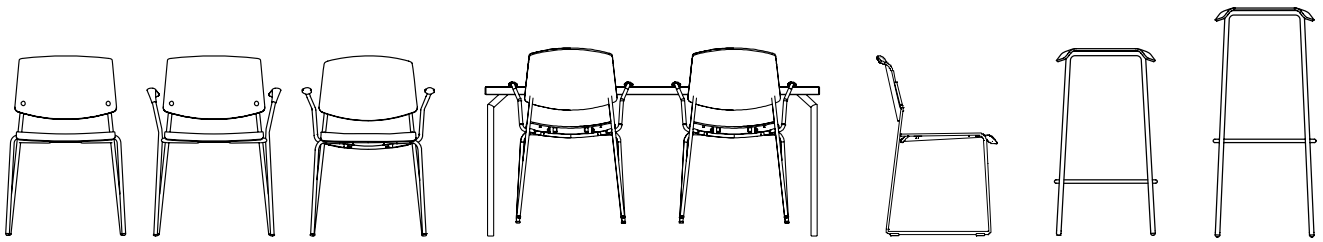

The Pause chair is designed to appear just as beautiful from the front as from behind. The expression is simple and light – like the chair that is easily stacked or put in rows. Available with or without arm rests pointing backwards or forward. Pause Bar Stool is also light and modern. The Pause chair series is also available with seat and back in a composite materiale.

WOOD & TREATMENTS



Oak,
transparent
lacquer

Oak, black-
stained

COMPOSITE COLOURS

See product details on the individual product pages



Brown grey
NCS S5005-
Y50R

Beige
NCS S2005-
Y30R

Black
NCS S9000-N

STEEL COLOURS



Tubular steel:
powder lacquer
in black, matt
grained lacquer

Tubular steel:
Bright chrome

LINOLEUM



Pebble
4175
NCS 3502-Y

Ash
4132
NCS 5502-G

Black
4023
NCS 9000-N

LAMINATE



Grey
U1115 W
Duropal
NCS S4502-G

White
F7949 Soft
white Formica
RAL 9016

Graphite
F7837 Graphite
Formica
RAL8019

Wood pattern oak
F 5374 Elegant oak
Formica

RECOMMENDED FABRIC, LEATHER & ARTIFICIAL LEATHER

GROUP A	GROUP B	GROUP C	LEATHER 1	LEATHER 2
Cura, Mainline Plus	Fame, Haku, Illusion, Remix 3	Hallingsdal 65, Steelcut Trio 3	Hero	Savanne

See the overview of fabric, leather and artificial leather on page 89

CERTIFICATIONS



EU Ecolabel certification on specific products:

- Pause with wood shell (866134)
- Pause with seat and back upholstery (8661)
- Pause Runner with seat and back in veneer (8640)
- Pause Runner with seat and back upholstery (8640)

PAUSE

DESIGN: (2005) BUSK + HERTZOG

SPECIFICATIONS & MEASUREMENTS

Description	Simple and light chair that can be easily stacked or lined up in rows.
Measurement	W53 x D53 x H80 x SH45 cm
Weight	Without upholstery: Gross/Net: 5,7/4,6 kg/pc. 5 pcs/cart. 0,395 cbm/cart With upholstery: Gross/Net: 5,7/4,6 kg/pc. 4 pcs/cart. 0,395 cbm/cart
Seat and back	Laminated plywood with laminate or linoleum, composite or oak veneer and fully or partially upholstered
Frame	Tubular steel
Stackable	Without upholstery: Floor: 10 pcs. Trolley 20 pcs. With upholstery: Floor: 8 pcs. Trolley 12 pcs.



PAUSE

Item No.	Product	Without upholstery	A	B	C	1	2
MO 8661	Seat and back in plywood with laminate or linoleum	3.825					
MO 8661	Seat and back in plywood with oak veneer	4.160					
MO 8661	Seat and back in black composite	3.325					
MO 8661	Seat and back in beige or brown-grey composite	4.070					
MO 8661	Back in laminate/linoleum/composite and seat upholstered		4.660	4.970	5.400	5.675	6.410
MO 8661	Seat and back fully upholstered		4.970	5.785	6.800	7.450	8.495

ADDITIONAL PURCHASE

Item No.	Product	Price
	Seat and back in black-stained oak	835
	Black screws in the back when the frame is black	250

ACCESSORIES

Item No.	Product	Price
MO 1387	Single hang-up bracket - two rods in bright chromed steel. Mini. Table length: 2 stole 140 cm/3 stole 200 cm. Min. table length: Mix table 80 cm, Brunch table 90 cm	795
MO 1201	Linking device - 1 set in black plastic - distance between the legs of the chairs: 1 cm	510
MO 1186	Trolley, painted black	14.700
MO 1501	Writing tablet, removable, white compact laminate with black core. Tubular steel in bright chrome	2.995
MO 1600	4 pcs loose hard glides, black, for soft floors	160
MO 1601	4 pcs. loose, less hard plastic glides, dark grey (for hard floors)	160
MO 1602	4 pcs. felt glides	185
MO 1834-1	1 set composite seat and back, black + screws	2.075
MO 1834-2	1 set composite seat and back, beige/brown-grey + screws	2.820

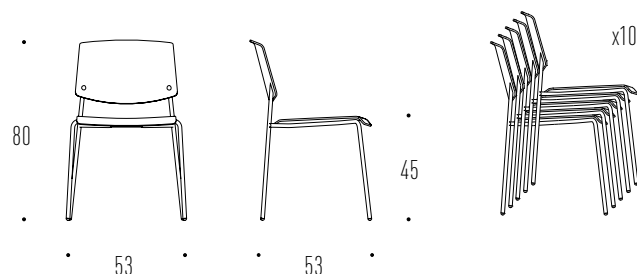

PAUSE WITH ARMREST

DESIGN: (2005) BUSK + HERTZOG

SPECIFICATIONS & MEASUREMENTS

Description	Simple and light stackable chair with armrests pointing backwards.
Measurement	W62 x D53 x H80 x SH45 cm
Weight	Without upholstery: Gross/Net: 8,8/7,7 kg/pc. 5 pcs/cart. 0,53 cbm/cart With upholstery: Gross/Net: 8,8/7,7 kg/pc. 4 pcs/cart. 0,53 cbm/cart
Seat and back	Laminated plywood with laminate or linoleum, composite or oak veneer and fully or partially upholstered
Frame	Tubular steel
Stackable	Floor: 10 pcs. Trolley 12 pcs.

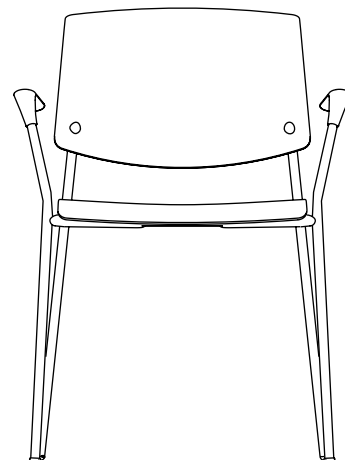

PAUSE WITH ARMREST

Item No.	Product	Without upholstery	A	B	C	1	2
MO 8662	Seat and back in plywood with laminate or linoleum	5.200					
MO 8662	Seat and back in plywood with oak veneer	5.550					
MO 8662	Seat and back in black composite	4.825					
MO 8662	Seat and back in beige or brown-grey composite	5.595					
MO 8662	Back in laminate/linoleum/composite and seat upholstered		6.025	6.375	6.835	7.100	7.895
MO 8662	Seat and back fully upholstered		6.460	7.295	8.285	8.920	9.975

ADDITIONAL PURCHASE

Item No.	Product	Price
	Seat and back in black-stained oak	835
	Black screws in the back when the frame is black	250

ACCESSORIES

Item No.	Product	Price
MO 1210	Linking device, fixed to Pause armchair - bright chrome	745
MO 1202	Linking device, detachable, for Pause armchair - bright chrome	745
MO 1186	Trolley, painted black	14.700
MO 1501	Writing tablet, removable, white compact laminate with black core. Tubular steel in bright chrome	2.995
MO 1600	4 pcs loose hard glides, black, for soft floors	160
MO 1601	4 pcs. loose, less hard plastic glides, dark grey (for hard floors)	160
MO 1602	4 pcs. felt glides	185
MO 1834-1	1 set composite seat and back, black + screws	2.075
MO 1834-2	1 set composite seat and back, beige/brown-grey + screws	2.820

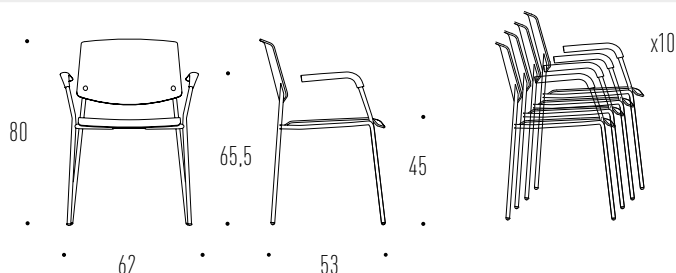

PAUSE WITH ARMREST POINTING FORWARDS

DESIGN: (2005) BUSK + HERTZOG

SPECIFICATIONS & MEASUREMENTS

Description	Simple and light chair with armrests pointing forward, which can be used for hanging up the chairs.
Measurement	W60 x D53 x H80 x SH45 cm
Weight	Gross/Net: 8,8/7,7 kg/pc. 4 pcs/cart. 0,49 cbm/cart
Seat and back	Laminated plywood with laminate or linoleum, composite or oak veneer and fully or partially upholstered
Frame	Tubular steel

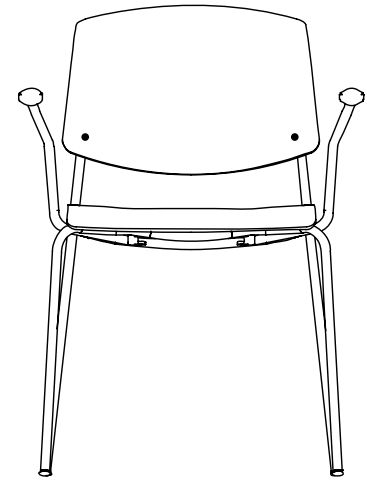

PAUSE WITH ARMREST POINTING FORWARDS

Item No.	Product	Without upholstery	A	B	C	1	2
MO 8653	Seat and back in plywood with laminate or linoleum	5.200					
MO 8653	Seat and back in plywood with oak veneer	5.550					
MO 8653	Seat and back in black composite	4.825					
MO 8653	Seat and back in beige or brown-grey composite	5.595					
MO 8653	Back in laminate/linoleum/composite and seat upholstered		6.025	6.375	6.835	7.100	7.895
MO 8653	Seat and back fully upholstered		6.460	7.295	8.285	8.920	9.975

ADDITIONAL PURCHASE

Item No.	Product	Price
	Seat and back in black-stained oak	835
	Black screws in the back when the frame is black	250

ACCESSORIES

Item No.	Product	Price
MO 1600	4 pcs loose hard glides, black, for soft floors	160
MO 1601	4 pcs. loose, less hard plastic glides, dark grey (for hard floors)	160
MO 1602	4 pcs. felt glides	185
MO 1834-1	1 set composite seat and back, black + screws	2.075
MO 1834-2	1 set composite seat and back, beige/brown-grey + screws	2.820

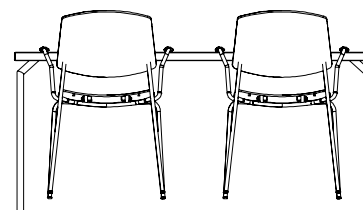
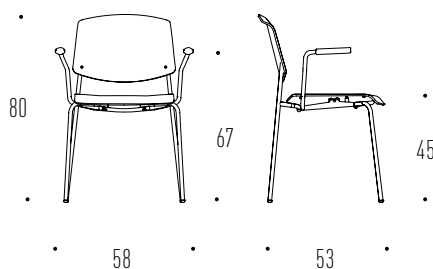

PAUSE RUNNER

DESIGN: (2016) BUSK + HERTZOG

SPECIFICATIONS & MEASUREMENTS

Description	Pause Runner is particularly suitable for row settings, stacking and storage on a trolley.
Measurement	W52 x D54 x H81 x SH45 cm
Weight	Gross/Net: 6.5/6 kg/pc. 4 pcs/cart. 0.395 cbm/cart
Seat and back	Laminated plywood with laminate or linoleum, composite or oak veneer and fully or partially upholstered
Frame	Tubular steel
Stackable	Without upholstery: Floor: 20 pcs. Trolley: 40 pcs. With upholstery: Floor: 10-12 pcs. Trolley: 20 pcs.

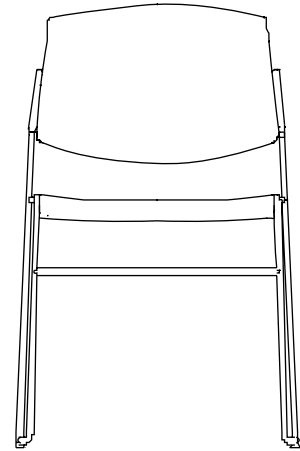

PAUSE RUNNER

Item No.	Product	Without upholstery	A	B	C	1	2
MO 8640	Seat and back in plywood with laminate or linoleum	4.325					
MO 8640	Seat and back in plywood with oak veneer	5.275					
MO 8640	Back in laminate/linoleum/composite and seat upholstered		4.995	5.435	5.870	6.145	6.600
MO 8640	Seat and back fully upholstered		5.210	5.995	6.960	7.585	8.575

ADDITIONAL PURCHASE

Item No.	Product	Price
	Seat and back in black-stained oak	835
	Built-in linking device (Minimum purchase 100 pcs.)	600

ACCESSORIES

Item No.	Product	Price
MO 1606	4 pcs loose, plastic glides, transparent	135
MO 1607	4 pcs loose, felt glides, transparent	335
MO 1503	Writing tablet, detachable - white laminate	2.995
MO 1156	Trolley, painted black, for up to 40 chairs	12.720

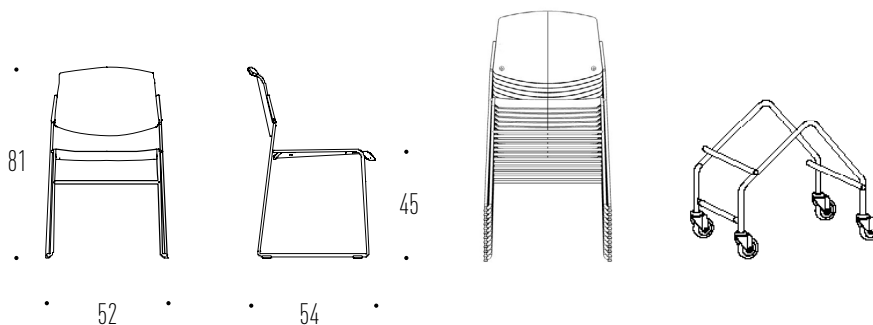

PAUSE BAR STOOL

DESIGN: (2006) BUSK + HERTZOG

SPECIFICATIONS & MEASUREMENTS

Description	Light bar chair with curved seat that makes it possible to sit up from all sides. Available in two heights, Bar and Counter height.
Measurement	MO 8664: W41 x D35 x H81 x SH81 cm MO 8663: W41 x D35 x H65 x SH65 cm
Weight	Gross/Net: 5,9/4,5 kg/pc. 2 pcs/cart. 0,339 kbm/kart
Seat	Laminated plywood with laminate/linoleum, oak veneer or upholstery
Frame	Tubular steel

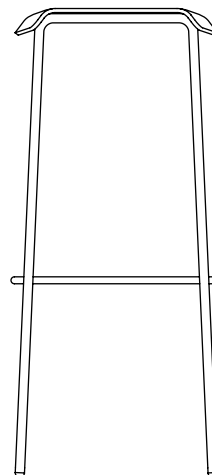

PAUSE BAR STOOL

Item No.	Product	Without upholstery	A	B	C	1	2
MO 8664, MO 8663	Seat in oak with laminate/linoleum	4.500					
MO 8664, MO 8663	Seat in oak	4.735					
MO 8664, MO 8663	Seat upholstery		4.975	5.775	6.295	6.625	7.150

ADDITIONAL PURCHASE

Item No.	Product	Price
	Seat in black-stained oak	835

ACCESSORIES

Item No.	Product	Price
MO 1600	4 pcs. hard plastic glides, black (for soft floors)	75
MO 1601	4 pcs. less hard plastic glides, grey (for soft floors)	75
MO 1602	4 pcs. felt glides	185

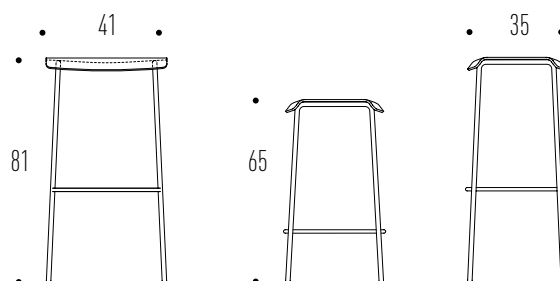

INFERNO

DESIGN: (2005) PELIKAN DESIGN

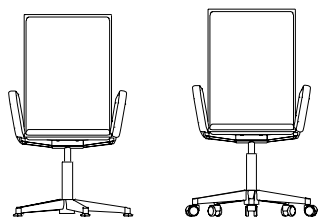

An office and meeting room chair in an elegant design with great lumbar support. The chair is available with characteristic channel stitching further emphasizing the slim and simple lines of the chair.

STEEL COLOURS



Polished
aluminium



Aluminium in
matt, black
grained lacquer

RECOMMENDED FABRIC, LEATHER & ARTIFICIAL LEATHER

GROUP A	GROUP B	GROUP C	LEATHER 1	LEATHER 2
Mainline Plus	Remix 3, Fame, Synergy	Hallingdal 65, Steelcut Trio 3	Sydney, Hero	Savanne, Vacona

See the overview of fabric, leather and artificial leather on page 89

INFERNO

DESIGN: (2005) PELIKAN DESIGN

SPECIFICATIONS & MEASUREMENTS

Description	Extremely comfortable office chair for the long days at the desk and the table.
Measurement	W64 x D64 x H106-121 x SH44-58 cm
Weight	Gross/Net: 16,9/14,9 kg/pc. 1pcs/cart. 0,440 cbm/cart
Seat and back	Fully upholstered
Frame	Aluminium
MO 5426	Glides, height adj. and tilting mech
MO 5406	Castors, height adj. and tilt. mech



INFERNO

Item No.	Product	A	B	C	1	2
MO 5426, MO 5406	Fully upholstered	22.985	23.995	25.335	26.195	34.460

ADDITIONAL PURCHASE

Item No.	Product	Price
	Base and armrest in black, grained lacquer	825
	Channel stitchings	2.200

ACCESSORIES

Item No.	Product	Price
MO 1608	1 set (5 pcs..) plastic glides, hard (for soft floors)	1.210
MO 1609	1 set (5 pcs..) plastic glides with felt (hard floors)	1.210
MO 1611	1 set (5 pcs..) Soft castors (for hard floors)	1.210
MO 1622	1 set (5 pcs..) Hard castors (for soft floors)	1.210

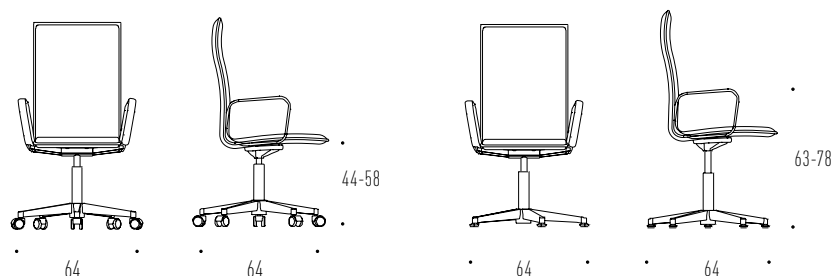

SESSION SERIES

DESIGN: (2003) BUSK + HERTZOG

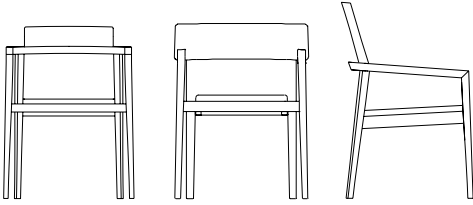

Japanese and Scandinavian aesthetics meet classic shaker traditions in the stackable armchairs in the Session Series. A simple design with a strong sense of form, meeting all demands with regards to comfort, strength and applicability.

WOOD & TREATMENTS

See product details on the individual product pages



Oak,
transparent
lacquer

Oak, natural
oil

Oak,
white-oil

Oak, soap
treatment

Oak, black-
stained

RECOMMENDED FABRIC, LEATHER & ARTIFICIAL LEATHER

GROUP A	GROUP B	GROUP C	LEATHER 1	LEATHER 2
Cura, Main Line Plus	Frame, Remix 3, Illusion, Haku	Hallingdal 65 og Steelcut Trio 3	Hero	Savanne, Triumph Crib (Triumph Crib suitable for use within the Care sector)

See the overview of fabric, leather and artificial leather on page 89

SESSION PURE

DESIGN: (2022) BUSK + HERTZOG

SPECIFICATIONS & MEASUREMENTS

Description	The curved wooden back gives the chair a distinctive look and a high degree of comfort at the same time.
Measurement	W58 x D54 x H77 x SH45 cm
Weight	Gross/Net: 7/6 kg/pc. 6 pcs/cart. 0,550 cbm/cart
Seat and back	Laminated plywood back with oak veneer, seat fully upholstered
Frame	Solid oak
Stackable	Floor: 10 pcs. Trolley: 10 pcs.



SESSION PURE

Item No.	Product	A	B	C	1	2
MO 9401	Back in oak and seat upholstered	7.085	7.825	8.250	8.750	9.250

ADDITIONAL PURCHASE

Item No.	Product	Price
	Back and frame in black-stained oak	835

ACCESSORIES

Item No.	Product	Price
MO 1637	2 built-in castors in front legs	2.000
MO 1694	Floor mounting brackets	510
MO 1194	Trolley for 10 chairs	11.560
MO 1616	4 pcs. plastic glides, white	135
MO 1617	4 pcs. felt glides, white	135

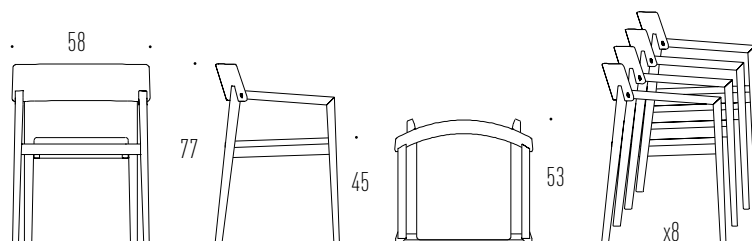

SESSION

DESIGN: (2003) BUSK + HERTZOG

SPECIFICATIONS & MEASUREMENTS

Description	Japanese and Scandinavian aesthetics meet shaker traditions in this stackable armchair.
Measurement	W58 x D52 x H77 x SH45 cm
Weight	Gross/Net: 7/6 kg/pc. 6 pcs/cart. 0,550 cbm/cart
Seat and back	Fully upholstered back and seat. Seat cushion is detachable and can be revolved 180°
Frame	Solid oak
Stackable	Floor: 10 pcs. Trolley: 10 pcs.



SESSION

Item No.	Product	A	B	C	1	2
MO 9401	Seat and back upholstered	12.095	12.720	13.445	13.925	14.685

ADDITIONAL PURCHASE

Item No.	Product	Price
	Frame in black-stained oak	835
MO 1826	Removable seat cover and urinary cover over foam	1.035

ACCESSORIES

Item No.	Product	Price
MO 1203	Linking device, removable, in stainless steel	675
MO 1637	2 built-in castors in front legs	2.000
MO 1694	Floor mounting brackets	510
MO 1194	Trolley for 10 chairs	11.560
MO 1616	4 pcs. plastic glides, white	135
MO 1617	4 pcs. felt glides, white	135

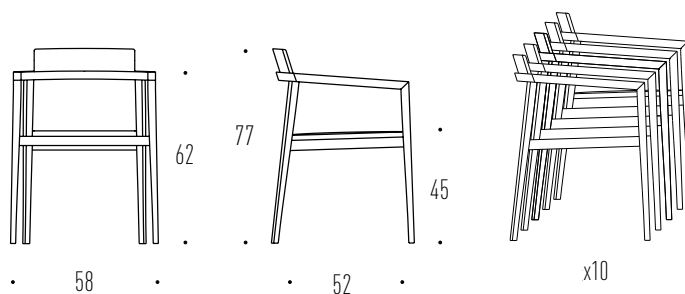

SESSION RELAX

DESIGN: (2003) BUSK + HERTZOG

SPECIFICATIONS & MEASUREMENTS

Description	Minimalistic design with great seating comfort, which makes it suitable as a conference/resting chair.
Measurement	W63 x D60 x H92 x SH45 cm
Weight	Gross/Net: 11.6/10 kg/pc. 3 pcs/cart. 0.550 cbm/cart
Back height	44 cm
Seat and back	Fully upholstered, removable back and seat cushion. Seat cushion is detachable and can be revolved 180°
Frame	Solid oak
Stackable	Floor: 6 pcs. Trolley: 6 pcs.

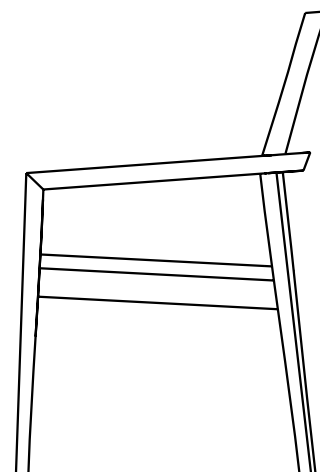

SESSION RELAX

Item No.	Product	A	B	C	1	2
MO 9406	Seat and back upholstered	13.775	15.125	16.800	17.810	19.520

ADDITIONAL PURCHASE

Item No.	Product	Price
	Frame in black-stained oak	835
MO 1827	Removable seat cover and urinary cover over foam	1.035

ACCESSORIES

Item No.	Product	Price
MO 1203	Linking device, removable, in stainless steel	675
MO 1637	2 built-in castors in front legs	2.000
MO 1694	Floor mounting brackets	510
MO 1194	Trolley for 6 chairs	11.560
MO 1616	4 pcs. plastic glides, white	135
MO 1617	4 pcs. felt glides, white	135

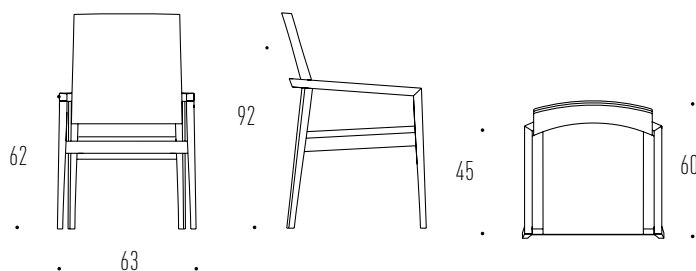

45-SERIES

DESIGN: (1971) RUD THYGESEN & JOHNNY SØRENSEN

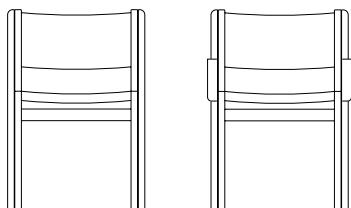

The 45-series chairs are simple and strong wooden chairs with or without armrests, all extremely suitable for spaces where there are extraordinary high demands with regards to strength, durability, stability, comfort as well as functionality, both in use and during cleaning. The series also consists of a large number of accessories, such as, removable seat, slide castors, linking devices, and transport cart etc.

WOOD & TREATMENTS



Laminated beech
with oak veneer with
transparent lacquer

RECOMMENDED FABRIC, LEATHER & ARTIFICIAL LEATHER

GROUP A	GROUP B	GROUP C	LEATHER 1	LEATHER 2
Cura, Main Line Plus	Fame, Remix 3, Illusion, Haku	Hallingdal, Steel Trio 3	Sydney, Hero	Savanne, Triumph Crib (Triumph Crib suitable for use within the Care sector)

See the overview of fabric, leather and artificial leather on page 89

45-SERIES

DESIGN: (1971) RUD THYGESEN & JOHNNY SØRENSEN

SPECIFICATIONS & MEASUREMENTS

Description	Suitable for places where high demands are placed on strength, durability, and stability.
Measurement	W54 x D56 x H78 x SH45 cm
Weight	Gross/Net: 8/6,9 kg/pc. 6 pcs/cart. 0,475 cbm/cart
Seat and back	Upholstered
Frame	Laminated beech with top veneer in oak
Stackable	Floor: 8 pcs. Trolley: 25 pcs. 25 pcs. MO4554 stacked on trolley: H230 cm

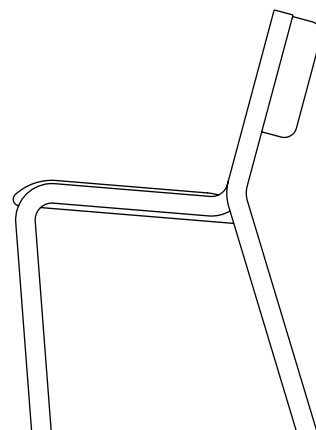

45-SERIES

Item No.	Product	A	B	C	1	2
MO 4554	Seat and back upholstered	6.135	6.825	7.670	8.200	9.075

ADDITIONAL PURCHASE

Item No.	Product	Price
MO 1829	Removable seat cover and urinary cover over foam	1.035
MO 1830	Removable seat cover and linen over seat foam	1.000
MO 1821	Additional, removable seat cover	1.585

INFO: MO 1821 is for chairs, delivered originally with removable seat cover - additional seat cover.

ACCESSORIES

Item No.	Product	Price
MO 1303	Double hang-up bracket	2.060
MO 1302	Single hang-up bracket	1.350
MO 1216	Fixed linking device, steel	650
MO 1245	Removable linking device, black plastic	310
MO 1504	Detachable writing tablet	3.250
MO 1166	Trolley, painted black. For 20 chairs (H196 cm) - for 25 chairs (H230 cm)	12.720
MO 1610	Slide castors for front legs, 1 set	2.285
MO 1643	2 built-in castors in front legs	1.445
MO 1626	4 pcs. plastic glides, white	185
MO 1625	4 pcs. felt glides, white	135

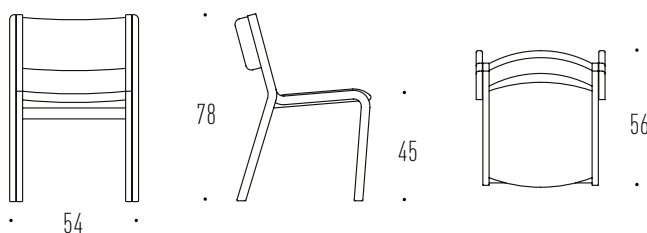

45-SERIES WITH ARMREST

DESIGN: (1971) RUD THYGESEN & JOHNNY SØRENSEN

SPECIFICATIONS & MEASUREMENTS

Description	Suitable for places where high demands are placed on strength, durability, and stability.
Measurement	W61 x D56 x H78 x SH45 cm
Weight	Gross/Net: 8,5/7,3 kg/pc. 6 pcs/cart. 0,54 cbm/cart
Seat and back	Upholstered
Frame and armrest	Laminated beech with plywood in oak veneer
Stackable	Floor: 8 pcs. Trolley: 8 pcs.

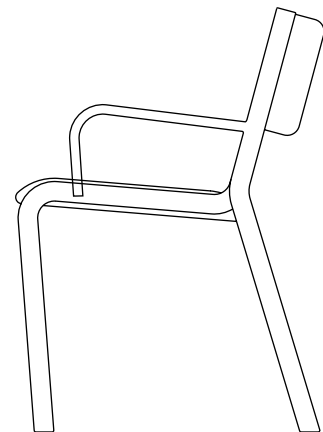

45-SERIES WITH ARMREST

Item No.	Product	A	B	C	1	2
MO 4564	Chair in laminated wood with oak veneer	7.725	8.420	9.260	9.800	10.670

ADDITIONAL PURCHASE

Item No.	Product	Price
MO 1829	Removable seat cover and urinary cover over foam	1.035
MO 1830	Removable seat cover and linen over seat foam	1.000
MO 1821	Additional, removable seat cover	1.585

ACCESSORIES

Item No.	Product	Price
MO 1504	Detachable writing tablet	3.250
MO 1166	Trolley, painted black. For 20 chairs (H196 cm)	12.720
MO 1610	Slide castors for front legs, 1 set	2.285
MO 1643	2 built-in castors in front legs	1.445
MO 1626	4 pcs. plastic glides, white	185
MO 1625	4 pcs. felt glides, white	135

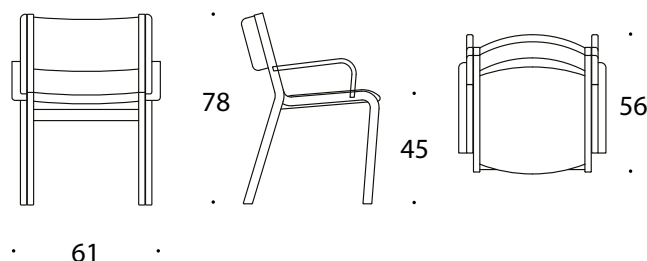

TONICA WOOD

DESIGN: (2013) NIELS GAMMELGAARD

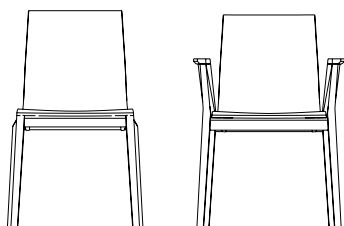

A modern idea of a simple wooden chair with a strong sense of form. Tonica Wood has a good lumbar support and flexibility in the back, ensuring a very high seating comfort. The chair is available in all wood and fully or partially upholstered, with or without armrests, and can be stacked.

WOOD & TREATMENTS



Oak,
transparent
lacquer



Oak, black-stained

RECOMMENDED FABRIC, LEATHER & ARTIFICIAL LEATHER

GROUP A	GROUP B	GROUP C	LEATHER 1	LEATHER 2
Cura, Main Line Plus	Fame, Remix 3, Illusion, Haku	Hallingdal 65, Steelcut Trio 3	Hero, Sydney	Savanne, Vacona

See the overview of fabric, leather and artificial leather on page 89

TONICA WOOD

DESIGN: (2013) NIELS GAMMELGAARD

SPECIFICATIONS & MEASUREMENTS

Description	Strong wooden chair with great lumbar support and flexibility in the back.
Measurement	W52 x D55 x H80 x SH45 cm
Weight	Gross/Net: 6,5/6 kg/pc. 3 pcs/cart. 0,41 cbm/cart
Seat and back	Laminated plywood with veneer in oak
Frame	Solid oak
Stackable	Without upholstery: Floor: 9 pcs. Trolley 9 pcs. With upholstery: Floor: 6 pcs. Trolley 6 pcs.

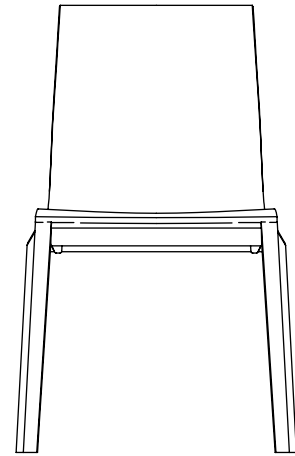

TONICA WOOD

Item No.	Product	Without upholstery	A	B	C	1	2
MO 5330	Chair in oak	7.570					
MO 5330	Fully upholstered		8.970	10.670	12.760	14.070	16.195
MO 5330	Front side upholstered		9.420	11.200	13.400	14.770	17.000

ADDITIONAL PURCHASE

Item No.	Product	Price
	Frame and shell in black-stained oak	835

ACCESSORIES

Item No.	Product	Price
MO 1204	Linking device, detachable (incl. of brackets on each chair)	835
MO 1211	Linking device/hymn book holder	1.100
MO 1616	4 pcs plastic glides, white	185
MO 1617	4 pcs felt glides, white	185
MO 1637	2 built-in castors in front legs	2.000
MO 1194	Trolley for 6-9 chairs	11.560

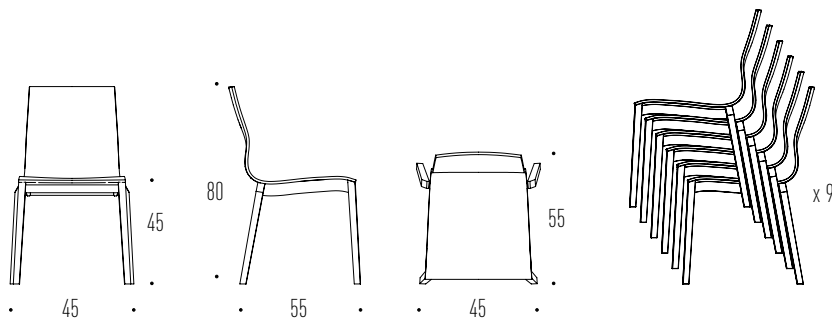

TONICA WOOD WITH ARMREST

DESIGN: (2013) NIELS GAMMELGAARD

SPECIFICATIONS & MEASUREMENTS

Description	Strong wooden chair with armrest and great lumbar support and flexibility in the back.
Measurement	B59 x D55 x H80 x SH45 cm
Weight	Gross/Net: 8/7,5 kg/pc. 3 pcs/cart. 0,41 cbm/cart
Seat and back	Laminated plywood with veneer in oak
Frame and armrest	Solid oak
Stackable	Without upholstery: Floor: 9 pcs. Trolley 9 pcs. With upholstery: Floor: 6 pcs. Trolley 6 pcs.

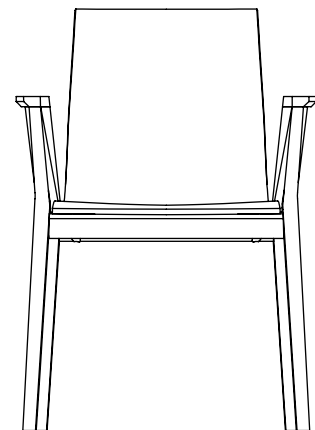

TONICA WOOD WITH ARMREST

Item No.	Product	Without upholstery	A	B	C	1	2
MO 5331	Chair in oak	8.750					
MO 5331	Fully upholstered		10.160	11.850	13.935	15.260	17.385
MO 5331	Front side upholstered		10.670	12.445	14.635	16.025	18.250

ADDITIONAL PURCHASE

Item No.	Product	Price
	Frame and shell in black-stained oak	835

ACCESSORIES

Item No.	Product	Price
MO 1205	Linking device, detachable (incl. of brackets on each chair)	835
MO 1212	Linking device/hymn book holder	1.195
MO 1616	4 pcs plastic glides, white	185
MO 1617	4 pcs felt glides, white	185
MO 1637	2 built-in castors in front legs	2.000
MO 1194	Trolley for 6-9 chairs	11.560

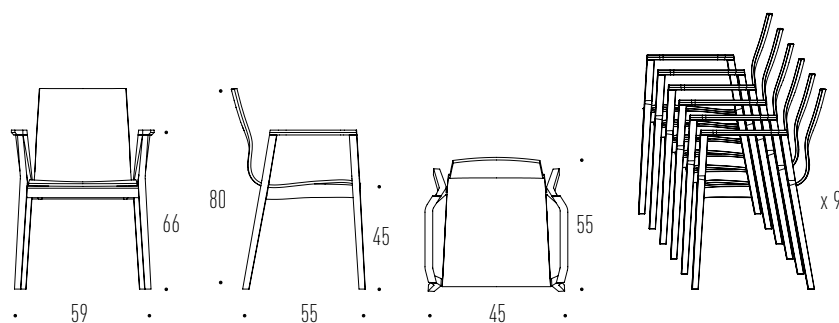

SOLACIA

DESIGN: (2015) LONE STORGAARD

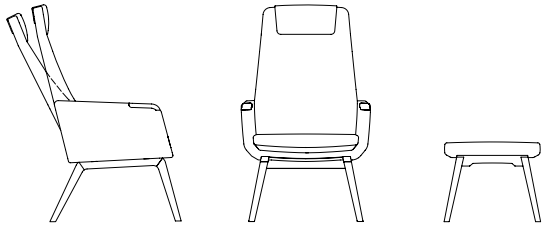

The Solacia resting chair is particularly suitable for the Care sector - created via user-driven innovation in a close cooperation between Gentofte Hospital, users, Magnus Olesen and designer Lone Storgaard. Solacia has a clear and stringent design, is comfortable, has slightly rounded shapes and is adapted to users who will sit in the chairs for longer periods of time to rest.

WOOD & TREATMENTS



Oak, transparent
lacquer

RECOMMENDED FABRIC, LEATHER & ARTIFICIAL LEATHER

GROUP A	GROUP B	GROUP C	LEATHER 1	LEATHER 2
Cura	Fame, Illusion, Haku, Remix 3	Hallingdal 65, Steelcut Trio 3	Hero	Triumph Crib (Triumph Crib suitable for use within the Care sector)

See the overview of fabric, leather and artificial leather on page 89

SOLACIA CHAIR & STOOL

DESIGN: (2015) LONE STORGAARD

SPECIFICATIONS & MEASUREMENTS

- Description** An extremely comfortable resting chair with stool developed especially for the care and health sector.
- Measurement** Chair: W60 x D69 x H113 cm
Stool: W50 x D40,5 x 39/41 cm
- Seat and back** Fully upholstered. The seat cushion of the chair is detachable and is available with removable seat cover and urinary cover
- Frame and armrest Details** Solid oak with transparent lacquer
The chair has a tilting mechanism to regulate the back tilt up to 12° and a detachable neck support. The stool also has a tilting mechanism.



SOLACIA CHAIR

Item No.	Product	A	B	C	1	2
MO 8473	Fully upholstered	36.525	42.500	49.635	54.120	61.360

SOLACIA STOOL

Item No.	Product	A	B	C	1	2
MO 8470	Fully upholstered	8.910	9.845	10.950	11.645	12.775

ADDITIONAL PURCHASE

Item No.	Product	Price
	Additional price for neck cushion in leather	1.660
MO 1831	Urinary cover over seat foam - seat cover detachable for MO 8473 (Solacia Chair)	1.700

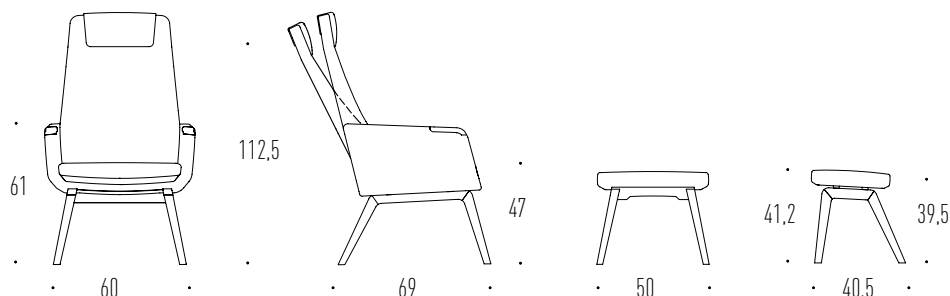

ADDI MEETING

DESIGN: (2013) FRIIS & MOLTKE DESIGN

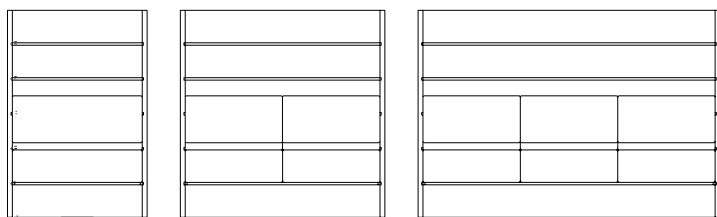

The purpose of Addi Meeting is as a flexible furniture element, ideal where people meet in various connections. Furniture element with high screening walls on the sides and the back, offering a more private *room in the room*. Addi Meeting is available as 1-, 2- and 3-seater modules. Seat and back cushions are detachable and thus easy to exchange and combinations of colours within each element become possible.

WOOD & TREATMENTS



Oak, transparent
lacquer

BASE COLOURS



Black painted

RECOMMENDED FABRIC, LEATHER & ARTIFICIAL LEATHER

GROUP A	GROUP B	GROUP C	LEATHER 1	LEATHER 2
Cura, Medley	Fame, Remix 3, Illusion	Hallingdal 65, Steelcut Trio 3	Hero	Savanne

See the overview of fabric, leather and artificial leather on page 89

ADDI MEETING

DESIGN: (2013) FRIIS & MOLTKE

SPECIFICATIONS & MEASUREMENTS

- Description** A flexible furniture element with high screening walls on the sides and back, offering a more private lounge area - especially suitable for open office environments
- Measurement** 3 size variants (1,2,3 seaters)
- Seat and back** Fully upholstered seat and back, both are detachable with side wall and back wall
- Frame** Painted black

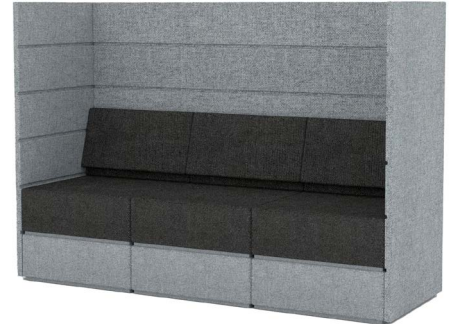

ADDI MEETING 1-SEATER

Item No.	Product	Size	A	B	C	1	2
MO 5354	Upholstered	W86 x D63 x H130 X SH45	34.845	44.250	46.600	62.520	73.885

ADDI MEETING 2-SEATER

Item No.	Product	Size	A	B	C	1	2
MO 5356	Upholstered	W126 x D63 x H130 X SH45	51.395	64.110	67.275	88.760	104.125

ADDI MEETING 3-SEATER

Item No.	Product	Size	A	B	C	1	2
MO 5357	Upholstered	W186 x D63 x H130 X SH45	75.310	92.835	97.195	126.785	147.935

MO 5354

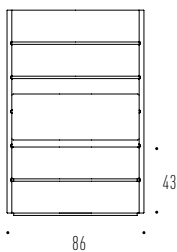

MO 5356

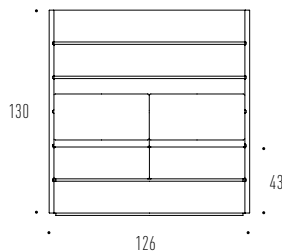

MO 5357

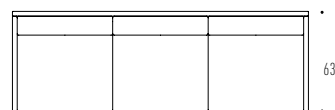
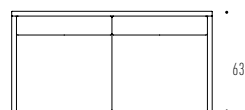
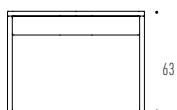
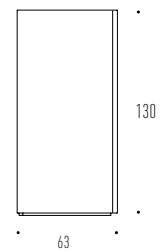
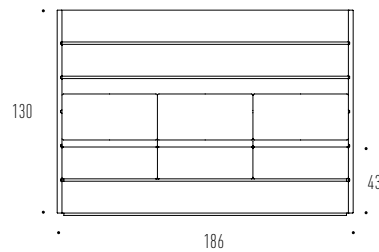

SLENDER

DESIGN: (2017) ANTONIO SCAFFIDI



Slender is a table with a slender expression and a continuously flowing contour along its edges. Legs and table top are arranged to visually unify these elements as one. This also underlines the pragmatic functionality of the design - no space is wasted. All corners are rounded softly. The core of the table top consists of Honeycomb which minimize material consumption and, at the same time, makes it strong and light-weight.

WOOD & TREATMENTS

See product details on the individual product pages



Oak, transparent lacquer
Oak, natural oil
Oak, white-oil
Oak, soap treatment
Oak, black-stained

LINOLEUM



Pebble 4175 NCS 3502-Y
Ash 4132 NCS 5502-G
Black 4023 NCS 9000-N

LAMINATE



Grey U1115 W Duropol NCS S4502-G
White F7949 Soft white Formica RAL 9016
Graphite F7837 Graphite Formica RAL8019
Wood pattern oak F 5374 Elegant oak Formica

CERTIFICATIONS



EU Ecolabel certification on specific products:

All Slender Dining Table variants in veneer

EU Ecolabel: DK/049/016

SLENDER

DESIGN: (2017) ANTONIO SCAFFIDI

SPECIFICATIONS & MEASUREMENTS

Description	A slim table with a continuously flowing contour along its edges, where legs and table top are combined.
Table height	74 cm
Table top	Light weight table top with rounded, beveled edges in solid oak
Surface	Oak veneer or linoleum/laminate (with linoleum, the edge is available in transparent lacquer or soap treatment)
Table legs	Solid oak



SLENDER

Item No.	Size	Price
MO 7100-1	80 x 80 cm	15.410
MO 7100-2	80 x 120 cm	17.500
MO 7100-12	80 x 140 cm	18.525
MO 7100-3	80 x 160 cm	19.560
MO 7100-4	80 x 180 cm	20.610
MO 7100-5	80 x 200 cm	21.645
MO 7100-14	80 x 220 cm	22.685
MO 7100-6	90 x 90 cm	16.510
MO 7100-7	90 x 120 cm	18.200
MO 7100-13	90 x 140 cm	19.345
MO 7100-8	90 x 160 cm	20.470
MO 7100-9	90 x 180 cm	21.585
MO 7100-10	90 x 200 cm	22.725
MO 7100-15	90 x 220 cm	23.875
MO 7100-11	100 x 200 cm	24.935

ADDITIONAL PURCHASE

Item No.	Product	Price
	Black-stained legs + edging for tables with linoleum/laminate	3.410
	Black-stained table top, legs, edgings for tables in veneer	3.410
	Hidden castors in two of the legs - price per castor	400

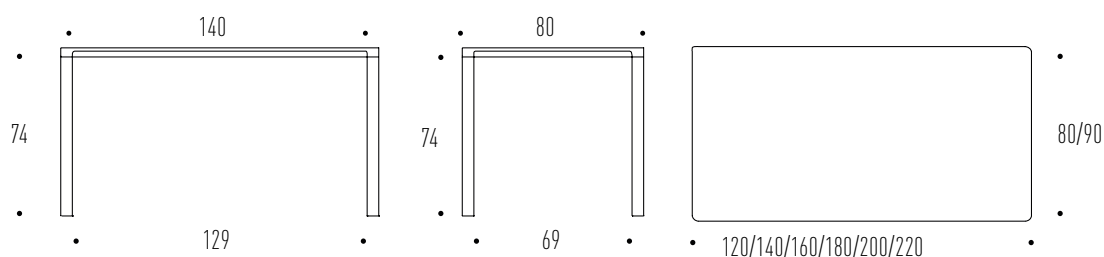

SLENDER COFFEE TABLE

DESIGN: (2017) ANTONIO SCAFFIDI

SPECIFICATIONS & MEASUREMENTS

Description	A series of nesting tables with a slim look and a continuous contour along the edges where its legs and table top are combined.
Table height	45 or 50 cm
Table top	Solid oak with rounded edges and corners
Table legs	Solid oak



SLENDER COFFEE TABLE

Item No.	Size	Price
MO 7110-2	40 x 32 cm	5.300
MO 7110-3	48 x 48 cm	7.500
MO 7110-1	80 x 80 cm	9.285
MO 7110-4	75 x 32 cm	7.500
MO 7110-5	120 x 40 cm	9.285

ADDITIONAL PURCHASE

Product	Price
Table top and frame in black-stained oak	1.585

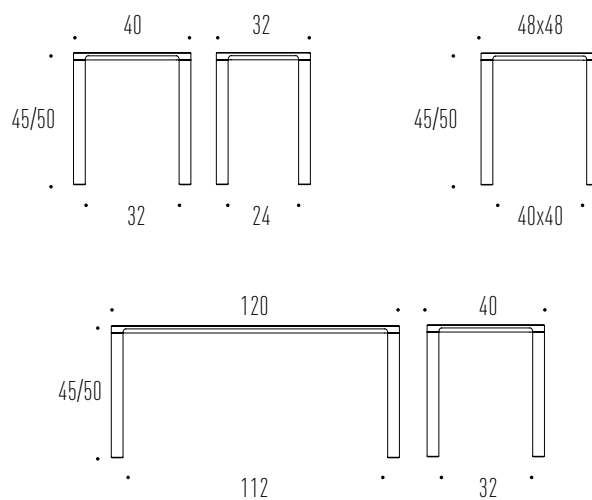

MIX TABLE SERIES

DESIGN: (1997) RUD THYGESEN & JOHNNY SØRENSEN

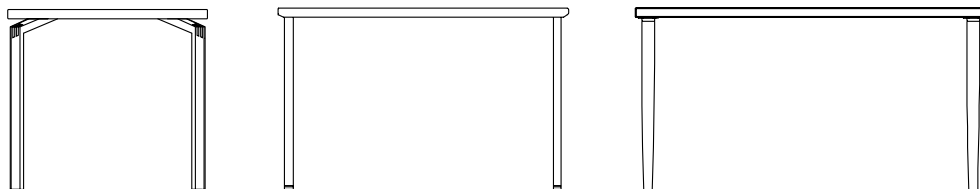

A simple modular table solution without rails – with many options. Thanks to the 'Honeycomb' table top, the table is light but at the same time robust and long-lasting. The tables can stand alone or be linked together by linking devices and additional leaves for individual arrangements. The Mix tables is available in classic finger joint wooden legs and standard conical wooden legs and folding leg.

WOOD & TREATMENTS

See product details on the individual product pages



Oak, transparent lacquer
Oak, natural oil
Oak, white-oil
Oak, soap treatment
Oak, black-stained

LINOLEUM



Pebble 4175 NCS 3502-Y
Ash 4132 NCS 5502-G
Black 4023 NCS 9000-N

LAMINATE



Grey U1115 W Duopal NCS S4502-G
White F7949 Soft white Formica RAL 9016
Graphite F7837 Graphite Formica RAL8019
Wood pattern oak F 5374 Elegant oak Formica

TABLE LEGS



SOLID, FINGER JOINT WOODEN LEGS

MO 7003

STANDARD CONICAL WOODEN LEGS

MO 7020 - STRAIGHT
MO 7021 - SLANTED

CONICAL WOODEN LEGS WITH FOLDING FUNCTION

MO 7007 - STRAIGHT
MO 7009 - SLANTED

FOLDING FUNCTION

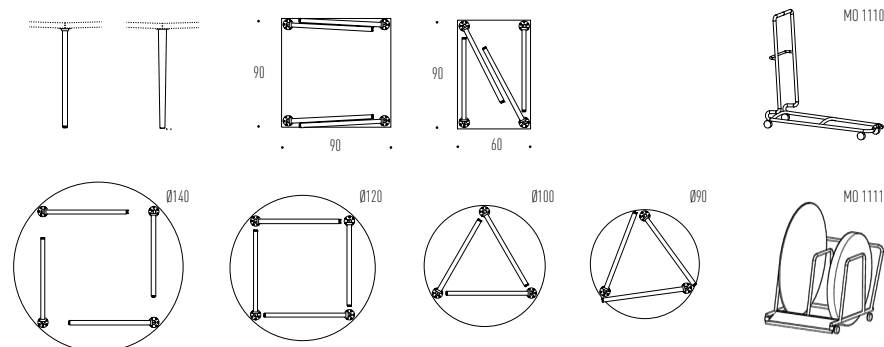

MIX TABLE SERIES

DESIGN: (1997) RUD THYGESEN & JOHNNY SØRENSEN

DIMENSIONER

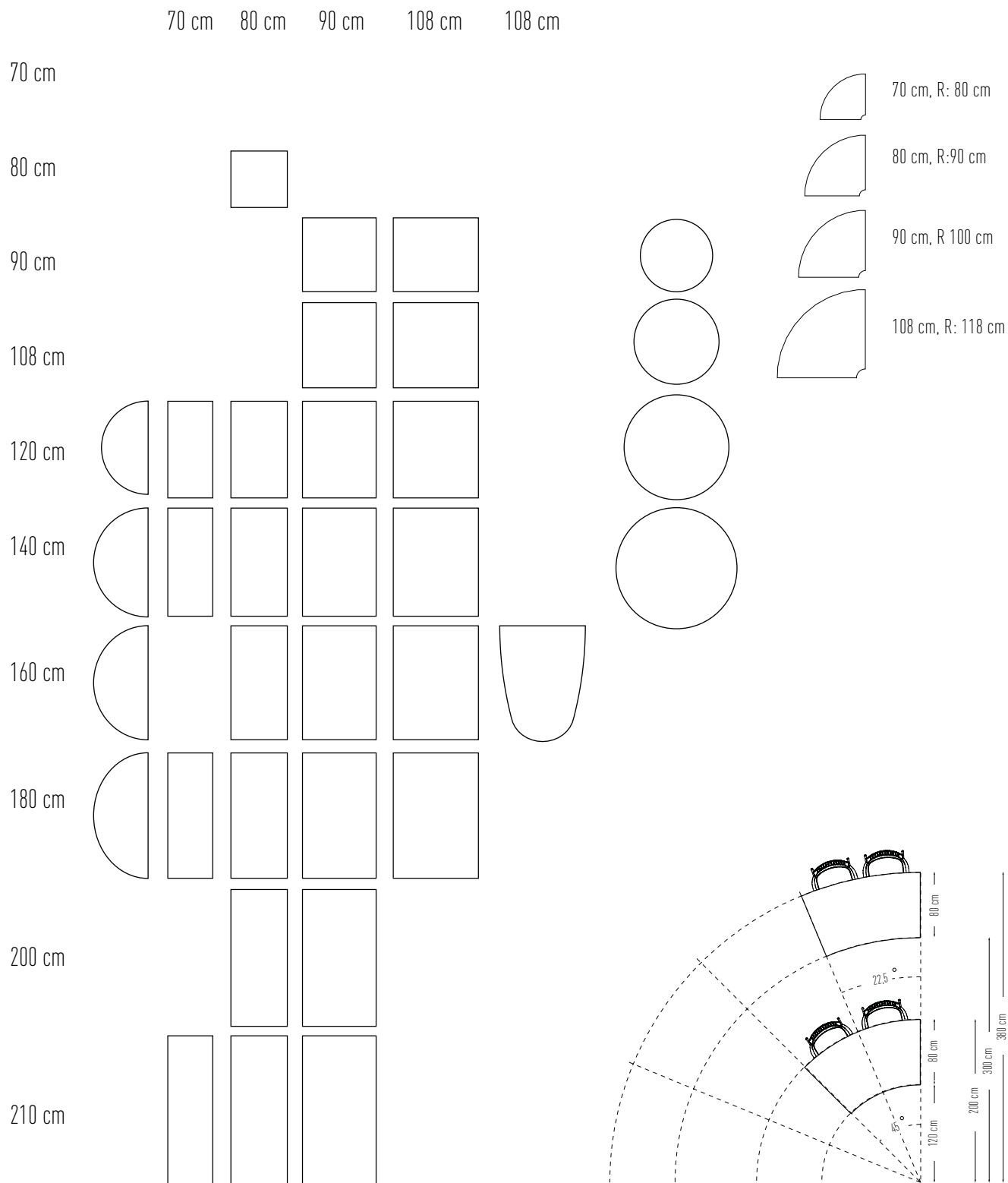

MIX WITH SOLID, FINGER JOINT WOODEN LEGS

DESIGN: (1997) RUD THYGESEN & JOHNNY SØRENSEN

SPECIFICATIONS & MEASUREMENTS

Description	Rectangular/square tables with solid, finger joint wooden legs.
Table height	50 or 74 cm
Table top thickness	37 mm
Table top	A core of honeycomb. Before the surface is glued on, 2x4 mm MDF is glued on the top and bottom side with surface in linoleum/laminate or oak veneer with edges in oak
Table legs	Solid oak
Extension leaf	With bushes for linking device or tenons



MIX WITH SOLID, FINGER JOINT WOODEN LEGS - RECTANGULAR/SQUARE

Item No.	Size	Table MO 7003	Extension leaf MO 7001
MO 7003-1	120 x 70 cm	15.280	6.810
MO 7003-2	140 x 70 cm	16.130	7.660
MO 7003-4	180 x 70 cm	17.855	9.385
MO 7003-6	80 x 80 cm	14.030	5.560
MO 7003-8	120 x 80 cm	15.920	7.450
MO 7003-9	140 x 80 cm	16.855	8.385
MO 7003-10	160 x 80 cm	17.805	9.335
MO 7003-11	180 x 80 cm	18.745	10.275
MO 7003-12	200 x 80 cm	19.695	11.225
MO 7003-65	210 x 80 cm	20.605	12.135
MO 7003-13	90 x 90 cm	15.015	6.545
MO 7003-14	108 x 90 cm	15.940	7.470
MO 7003-15	120 x 90 cm	16.565	8.095
MO 7003-16	140 x 90 cm	17.580	9.110
MO 7003-17	160 x 90 cm	18.620	10.150
MO 7003-18	180 x 90 cm	19.645	11.175
MO 7003-19	200 x 90 cm	20.670	12.200

See more sizes on the next side

MIX WITH SOLID, FINGER JOINT WOODEN LEGS

DESIGN: (1997) RUD THYGESEN & JOHNNY SØRENSEN

SPECIFICATIONS & MEASUREMENTS

Description	Rectangular/square tables with solid, finger joint wooden legs.
Table height	50 or 74 cm
Table top thickness	37 mm
Table top	A core of honeycomb. Before the surface is glued on, 2x4 mm MDF is glued on the top and bottom side with surface in linoleum/laminate or oak veneer with edges in oak
Table legs	Solid oak
Extension leaf	With bushes for linking device or tenons



MIX WITH SOLID, FINGER JOINT WOODEN LEGS - RECTANGULAR/SQUARE

Item No.	Size	Table MO 7003	Extension leaf MO 7001
MO 7003-20	108 x 108 cm	16.995	8.525
MO 7003-21	120 x 108 cm	17.720	9.250
MO 7003-22	140 x 108 cm	18.890	10.420
MO 7003-23	160 x 108 cm	20.090	11.620
MO 7003-24	180 x 108 cm	21.265	12.795

ADDITIONAL PURCHASE

Item No.	Product	Price
	Black-stained legs and edging for tables with linoleum/laminate	3.400
	Black-stained oak	3.400
	Hidden castors - not swiveling, price per castor	400

ACCESSORIES

Item No.	Product	Price
MO 1403	Solid finger joint wooden leg for table height 74 cm or 50 cm - per leg	2.520
MO 1625	4 pcs. felt glides	185
MO 1628	4 pcs. plastic glides	185
MO 2998	Linking device	250
MO 1631	Castor, 75 mm, with brake, per castor	860
MO 1630	Castor, 75 mm, without brake, per castor	725
MO 1702	Wooden wire management cap in oak, beech - aluminium ring, Ø 7 cm, mounted	1.570

MIX WITH SOLID, FINGER JOINT WOODEN LEGS

DESIGN: (1997) RUD THYGESEN & JOHNNY SØRENSEN

SPECIFICATIONS & MEASUREMENTS

Description	Round/semi-round and oval tables with solid, finger joint wooden legs.
Table height	50 or 74 cm
Table top thickness	37 mm
Table top	A core of honeycomb. Before the surface is glued on, 2x4 mm MDF is glued on the top and bottom side with surface in linoleum/laminate or oak veneer with edges in oak
Table legs	Solid oak
Extension leaf	With bushes for linking device or tenons



MIX WITH SOLID, FINGER JOINT WOODEN LEGS - ROUND/SEMI-ROUND AND OVAL

Item No.	MO 7003-50	MO 7003-51	MO 7003-25	MO 7003-26	MO 7003-27	MO 7003-28	MO 7003-38
Size	22,5° 148 X 80 cm	45° 153 X 80 cm	1/2 Ø120	1/2 Ø140	1/2 Ø160	1/2 Ø180	Semi oval 160 x 108 cm
Table 7003	19.490	19.695	15.680	17.345	19.180	21.195	22.190
Extension Leaf 7001	11.020	11.225	7.210	8.875	10.710	12.725	13.720

Item No.	MO 7003-30	MO 7003-31	MO 7003-70	MO 7003-71	MO 7003-62	MO 7003-63	MO 7003-64
Size	Ø 90 cm	Ø 108 cm	Ø 120 cm	Ø 140 cm*)	1/4 Ø 180 80 x 80 cm	1/4 Ø 200 90 x 90 cm	1/4 Ø 236 108 x 108 cm
Table 7003	16.545	18.855	23.120	25.970	15.455	16.520	18.620
Extension Leaf 7001	8.075	10.385	14.650	17.500	6.985	8.050	10.150

*) Ø 140 cm available with linoleum or oak veneer. If laminate is desired - contact the factory for possible laminate colours

ADDITIONAL PURCHASE

Item No.	Product	Price
	Black-stained legs and edging for tables with linoleum/laminate	3.400
	Black-stained oak	3.400

ACCESSORIES

Item No.	Product	Price
MO 1403	Solid finger joint wooden leg for table height 74 cm or 50 cm - per leg	2.520
MO 1625	4 pcs. felt glides	185
MO 1628	4 pcs. plastic glides	185
MO 2998	Linking device	250
MO 1631	Castor, 75 mm, with brake, per castor	860
MO 1630	Castor, 75 mm, without brake, per castor	725
MO 1702	Wooden wire management cap in oak, beech - aluminium ring, Ø 7 cm, mounted	1.570

MIX WITH CONICAL WOODEN LEGS

DESIGN: (1997) RUD THYGESEN & JOHNNY SØRENSEN

SPECIFICATIONS & MEASUREMENTS

Description	Rectangular/square tables with conical wooden legs with/without folding
Table height	50 or 74 cm
Table top thickness	37 mm
Table top	A core of honeycomb. Before the surface is glued on, 2x4 mm MDF is glued on top and bottom side with surface: linoleum/laminate or oak veneer with edges in oak
Table legs	Solid oak, straight (MO 7020) or slanted with a 5 degree slant outwards (MO 7021)
Folding legs	Solid oak, straight (MO 7007) or slanted with a 5 degree slant outwards (MO 7009)
Extension leaf	With bushes for linking device or tenons
Stacking	Trolley for 10 pcs. rectangular



MIX WITH CONICAL WOODEN LEGS - RECTANGULAR/SQUARE

Item No.	Size	Table with standard legs	Table with folding legs	Extension leaf
		MO 7020 (straight)/MO 7021 (slanted)	MO 7007 (straight)/MO 7009 (slanted)	MO 7001
MO 7020/7021/7007/7009/7001-1	120 x 70 cm	12.495	16.980	6.810
MO 7020/7021/7007/7009/7001-2	140 x 70 cm	13.345	17.830	7.660
MO 7020/7021/7007/7009/7001-4	180 x 70 cm	15.070	19.555	9.385
MO 7020/7021/7007/7009/7001-6	80 x 80 cm	11.245	15.730	5.560
MO 7020/7021/7007/7009/7001-8	120 x 80 cm	13.135	17.620	7.450
MO 7020/7021/7007/7009/7001-9	140 x 80 cm	14.070	18.555	8.385
MO 7020/7021/7007/7009/7001-10	160 x 80 cm	15.020	19.505	9.335
MO 7020/7021/7007/7009/7001-11	180 x 80 cm	15.960	20.445	10.275
MO 7020/7021/7007/7009/7001-12	200 x 80 cm	16.910	21.395	11.225
MO 7020/7021/7007/7009/7001-65	210 x 80 cm	17.820	22.305	12.135
MO 7020/7021/7007/7009/7001-13	90 x 90 cm	12.230	16.715	6.545
MO 7020/7021/7007/7009/7001-14	108 x 90 cm	13.155	17.640	7.470
MO 7020/7021/7007/7009/7001-15	120 x 90 cm	13.780	18.265	8.095
MO 7020/7021/7007/7009/7001-16	140 x 90 cm	14.795	19.280	9.110
MO 7020/7021/7007/7009/7001-17	160 x 90 cm	15.835	20.320	10.150
MO 7020/7021/7007/7009/7001-18	180 x 90 cm	16.860	21.345	11.175
MO 7020/7021/7007/7009/7001-19	200 x 90 cm	17.885	22.370	12.200

See more sizes on the next side

MIX WITH CONICAL WOODEN LEGS

DESIGN: (1997) RUD THYGESEN & JOHNNY SØRENSEN

SPECIFICATIONS & MEASUREMENTS

Description	Rectangular/square tables with conical wooden legs with/without folding
Table height	50 or 74 cm
Table top thickness	37 mm
Table top	A core of honeycomb. Before the surface is glued on, 2x4 mm MDF is glued on top and bottom side with surface: linoleum/laminate or oak veneer with edges in oak
Table legs	Solid oak, straight (MO 7020) or slanted with a 5 degree slant outwards (MO 7021)
Folding legs	Solid oak, straight (MO 7007) or slanted with a 5 degree slant outwards (MO 7009)
Extension leaf	With bushes for linking device or tenons
Stacking	Trolley for 10 pcs. rectangular or square folding tables



MIX WITH CONICAL WOODEN LEGS - RECTANGULAR/SQUARE

Item No.	Size	Table with standard legs	Table with folding legs	Extension leaf
		MO 7020 (straight)/MO 7021 (slanted)	MO 7007 (straight)/MO 7009 (slanted)	MO 7001
MO 7020/7021/7007/7009/7001-20	108 x 108 cm	14.210	18.695	8.525
MO 7020/7021/7007/7009/7001-21	120 x 108 cm	14.935	19.420	9.250
MO 7020/7021/7007/7009/7001-22	140 x 108 cm	16.105	20.590	10.420
MO 7020/7021/7007/7009/7001-23	160 x 108 cm	17.305	21.790	11.620
MO 7020/7021/7007/7009/7001-24	180 x 108 cm	18.480	22.965	12.795

ADDITIONAL PURCHASE

Product	Price
Black-stained legs and edging for tables with linoleum/laminate	3.400
Black-stained oak	3.400
Hidden castors - not swiveling, price per castor	400

ACCESSORIES

Item No.	Product	Price
MO 1625	4 pcs. felt glides	185
MO 1628	4 pcs. plastic glides	185
MO 2998	Linking device	250
MO 1702	Wooden wire management cap in oak, beech - aluminium ring, Ø 7 cm, mounted	1.570
MO 1110	Trolley, painted black, for tables with folding legs - for approx. 10 tables. W60 x L150 x H135 cm	24.000







MIX WITH CONICAL WOODEN LEGS







DESIGN: (1997) RUD THYGESEN & JOHNNY SØRENSEN

SPECIFICATIONS & MEASUREMENTS

Description	Round/semi-round and oval tables with conical wooden legs with/without folding
Table height	50 or 74 cm
Table top thickness	37 mm
Table top	A core of honeycomb. Before the surface is glued on, 2x4 mm MDF is glued on top and bottom side with surface: linoleum/laminate or oak veneer with edges in oak
Table legs	Solid oak, straight (MO 7020) or slanted with a 5 degree slant outwards (MO 7021)
Foldeben	Solid oak, straight (MO 7007) or slanted with a 5 degree slant outwards (MO 7009)
Extension leaf	With bushes for linking device or tenons
Stacking	Trolley for 7 pcs. round/semi-round folding tables

MIX WITH CONICAL WOODEN LEGS - ROUND/SEMI-ROUND AND OVAL

							
Item No.	MO 7020-50	MO 7020-51	MO 7020-25	MO 7020-26	MO 7020-27	MO 7020-28	MO 7020-38
Size	22,5° 148 X 80 cm	45° 153 X 80 cm	1/2 Ø120	1/2 Ø140	1/2 Ø160	1/2 Ø180	Semi oval 160 x 108 cm
Standard leg 7020/7021	15.284	15.489	11.474	13.139	14.974	16.989	19.405
Folding leg 7007/7009	18.648	18.853	14.838	16.503	18.338	20.353	23.890
Extension leaf 7001	11.020	11.225	7.210	8.875	10.710	12.725	13.720

							
Item No.	MO 7020-30	MO 7020-31	MO 7020-70	MO 7020-71	MO 7020-62	MO 7020-63	MO 7020-64
Size	Ø 90 cm	Ø 108 cm	Ø 120 cm	Ø 140 cm*)	1/4 Ø 180 80 x 80 cm	1/4 Ø 200 90 x 90 cm	1/4 Ø 236 108 x 108 cm
Standard leg 7020/7021	13.760	16.070	20.335	23.185	12.670	13.735	15.835
Folding leg 7007/7009	18.245	20.555	24.820	27.670	17.155	18.220	20.320
Extension leaf 7001	8.075	10.385	14.650	17.500	6.985	8.050	10.150

ADDITIONAL PURCHASE

Item No.	Product	Price
	Black-stained legs and edging for tables with linoleum/laminate	3.400
	Black-stained oak	3.400
	Hidden castors - not swiveling, price per castor	400

ACCESSORIES

Item No.	Product	Price
MO 1625	4 pcs. felt glides	185
MO 1628	4 pcs. plastic glides	185
MO 2998	Linking device	250
MO 1702	Wooden wire management cap in oak, beech - aluminium ring, Ø 7 cm, mounted	1.570
MO 1111	Trolley, painted black, for circular/semi-circular tables. W85 x L134 x H101 cm. Internal width: 77 cm	21.375

BRUNCH TABLE SERIES

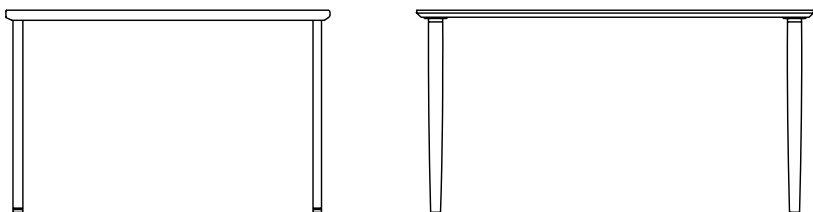

Brunch is a distinctive table with a simple, sleek and clear-cut expression. The 2,2mm slim table top of plywood is robust, and especially with a surface of high-pressure laminate, extremely durable and particularly suitable for canteens, cafés and waiting areas. Brunch is available with steel or wooden legs as a regular standard table, or with foldable legs.

WOOD & TREATMENTS

See product details on the individual product pages



Oak, transparent lacquer
Oak, natural oil
Oak, white-oil
Oak, soap treatment
Oak, black-stained

LINOLEUM



Pebble 4175
NCS 3502-Y
Ash 4132
NCS 5502-G
Black 4023
NCS 9000-N

LAMINATE



Grey U1115 W
Duropal NCS S4502-G
White F7949 Soft
white Formica RAL 9016
Graphite F7837 Graphite
Formica RAL8019
Wood pattern oak F 5374 Elegant oak
Formica

STEEL COLOURS



Powder lacquer in black, matt grained lacquer
Bright chrome

TABLE LEGS



STANDARD STEEL LEGS
MO 6671



STANDARD CONICAL WOODEN LEGS
MO 6676



STEEL FOLDING LEGS
MO 6665 - STRAIGHT
MO 6667 - SLANTED

WOODEN FOLDING LEGS
MO 6666 - STRAIGHT
MO 6668 - SLANTED

BRUNCH TABLE SERIES

DIMENSIONER

	70 cm	80 cm	90 cm
80 cm			
90 cm			
120 cm			
140 cm			
180 cm			
200 cm			
210 cm			

FOLDING FUNCTION

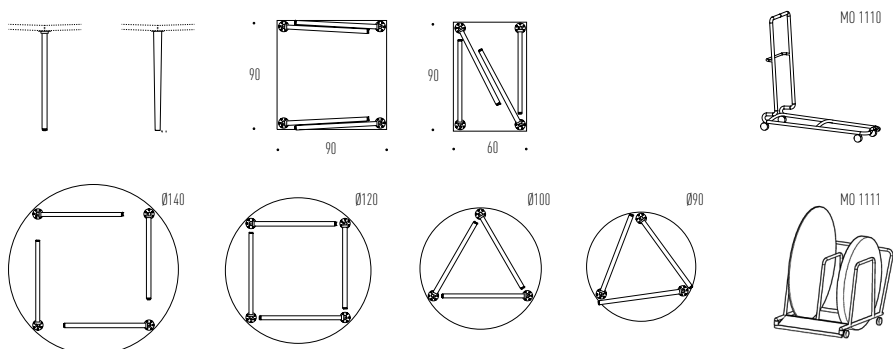

BRUNCH WITH STEEL LEGS

SPECIFICATIONS & MEASUREMENTS

Description	Extremely durable table series with/without folding function.
Table height	74 cm
Table top	25 mm slim table top in plywood with chamfered plywood edge, lacquered or black stained, or straight ABS-edge
Table legs	Steel legs are mounted in a 90 degree angle on table top. Standard with adjustable glide
Folding legs	Straight (MO 6665) or slanted with a 5 degree slant outwards (MO 6667)
Stacking	Trolleys for folding tables - 10 rectangular or 7 round



BRUNCH WITH STEEL LEGS

Item No.	Size	Table with steel legs	Table with steel folding legs
		MO 6671	MO 6665 (straight)/MO 6667 (slanted)
MO 6671/6665/6667-0	70 x 120 cm	8.465	13.020
MO 6671/6665/6667-1	70 x 140 cm	9.305	13.860
MO 6671/6665/6667-2	80 x 80 cm	7.670	
MO 6671/6665/6667-3	80 x 120 cm	9.220	13.775
MO 6671/6665/6667-4	80 x 140 cm	10.005	14.560
MO 6671/6665/6667-5	80 x 160 cm	11.570	
MO 6671/6665/6667-6	80 x 180 cm	11.690	16.245
MO 6671/6665/6667-7	80 x 200 cm	12.530	17.085
MO 6671/6665/6667-11	90 x 90 cm	8.765	13.320
MO 6671/6665/6667-12	90 x 140 cm	10.765	15.320
MO 6671/6665/6667-13	90 x 200 cm	13.630	18.185
MO 6671/6665/6667-14	90 x 210 cm	14.205	18.760
MO 6671/6665/6667-9	Ø120 cm	11.205	15.760

ADDITIONAL PURCHASE

Item No.	Product	Price
	Black-stained table top in veneer	1.585

ACCESSORIES

Item No.	Product	Price
MO 1110	Trolley, painted black, for rectangular tables with folding legs - for approx. 10 tables. W60xL150xH136 cm	24.000
MO 1111	Trolley, painted black, for circular tables. W85xD134XK101 cm. Internal width: 77 cm	21.375

BRUNCH WITH CONICAL WOODEN LEGS

SPECIFICATIONS & MEASUREMENTS

Description	Extremely durable table series with/without folding function.
Table height	74 cm
Table top	25 mm slim table top in plywood with chamfered plywood edge, lacquered or black stained, or straight ABS-edge
Table legs	Conical wooden legs are mounted in a 90 degree angle on the table top
Folding legs	Straight (MO 6666) or slanted with a 5 degree slant outwards (MO 6668)
Stacking	Trolleys for folding tables - 10 rectangular or 7 round



BRUNCH WITH CONICAL WOODEN LEGS

Item No.	Size	Table with conical wooden legs	
		MO 6676	MO 6666 (straight)/MO 6668 (slanted)
MO 6676-0	70 x 120 cm	10.330	14.815
MO 6676-1	70 x 140 cm	11.170	15.655
MO 6676-2	80 x 80 cm	9.535	
MO 6676-3	80 x 120 cm	11.085	15.570
MO 6676-4	80 x 140 cm	11.870	16.355
MO 6676-5	80 x 160 cm	13.435	
MO 6676-6	80 x 180 cm	13.555	18.040
MO 6676-7	80 x 200 cm	14.395	18.880
MO 6676-10	80 x 210 cm	14.935	19.420
MO 6676-11	90 x 90 cm	10.630	15.115
MO 6676-12	90 x 140 cm	12.630	17.115
MO 6676-13	90 x 200 cm	15.495	19.980
MO 6676-14	90 x 210 cm	16.070	20.555
MO 6676-8	Ø90 cm	9.235	13.720
MO 6676-9	Ø120 cm	13.070	17.555

ADDITIONAL PURCHASE

Item No.	Product	Price
	Table top and legs in black-stained oak	1.585
MO 6673	Hidden castors, not swiveling per castor - only for rectangular and square tables	325

ACCESSORIES

Item No.	Product	Price
MO 1110	Trolley, painted black, for rectangular tables with folding legs - for approx. 10 tables. W60xL150xH136 cm	24.000
MO 1111	Trolley, painted black, for circular tables. W85xD134XK101 cm. Internal width: 77 cm	21.375

CONTACT

DESIGN: (2004) BUSK + HERTZOG

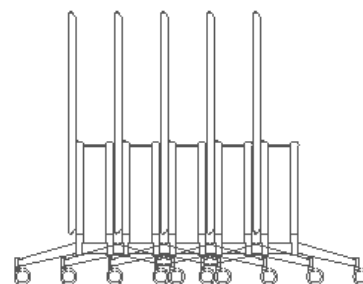
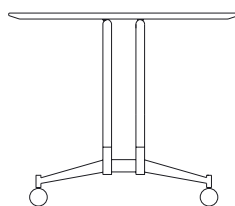

A flexible and mobile working table fitted with castors and horizontally stackable when the table top is raised – without lifting or using any strength.

WOOD & TREATMENTS



Oak,
transparent
lacquer



Oak, black-
stained

LINOLEUM



Pebble
4175
NCS 3502-Y



Ash
4132
NCS 5502-G



Black
4023
NCS 9000-N

LAMINATE



Grey
U1115 W
Duropal
NCS S4502-G



White
F7949 Soft
white Formica
RAL 9016



Graphite
F7837 Graphite
Formica
RAL8019



Wood pattern oak
F 5374 Elegant oak
Formica

STEEL COLOURS



Transverse steel
feet: Bright
chrome



Vertical tubular steel
tubes: Bright chrome
or powder lacquer in
black, matt grained
lacquer

TABLE EDGE



1. Straight ABS edgings: Surface with laminate or linoleum, with ABS edgings in matching colour. Thickness of table top: 30 mm

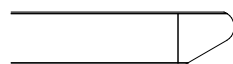

2. Beveled wooden edgings in oak: Surface with laminate, or wood pattern, or linoleum or in oak veneer. Thickness of table top: 30 mm

CONTACT

DESIGN: (2004) BUSK + HERTZOG

DIMENSIONER

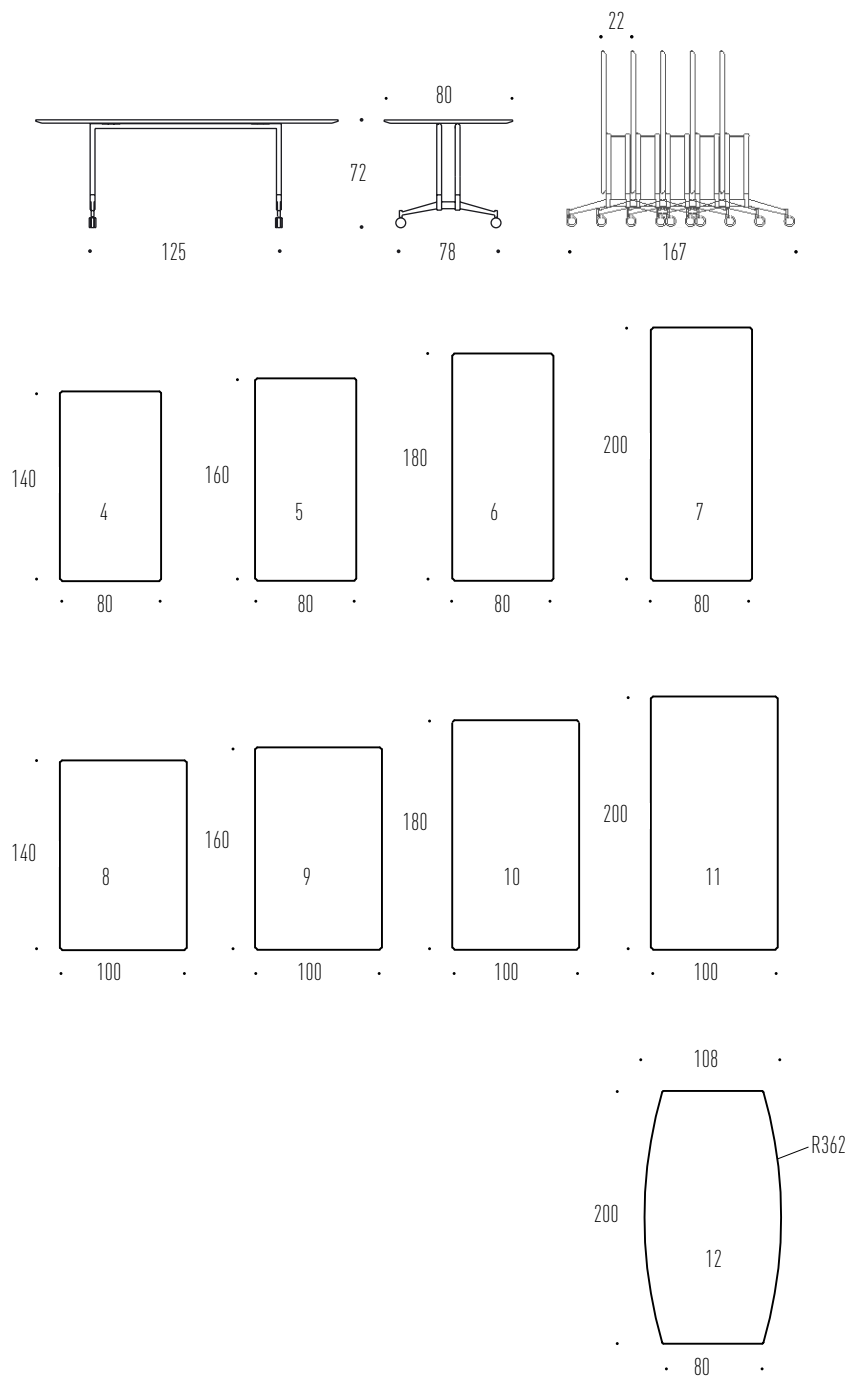

CONTACT

DESIGN: (2004) BUSK + HERTZOG

SPECIFICATIONS & MEASUREMENTS

Description	Flip top table with castors, easily stored in minimal space.
Table height	72 cm
Table top thickness	30 mm
Surface	Linoleum/laminate or oak veneer - only with beveled wooden edgings with oak.
Table edge	Straight ABS edge or beveled solid wooden edging in oak with transparent lacquer
Frame	Transverse foot and vertical tubes in steel
Details	Stack horizontally with only 22 cm between each table



CONTACT TABLE

Item No.	Size	Price with ABS-edge
MO 8591-4	140 x 80 cm	23.295
MO 8591-5	160 x 80 cm	24.060
MO 8591-6	180 x 80 cm	24.850
MO 8591-7	200 x 80 cm	25.625
MO 8591-8	140 x 100 cm	24.650
MO 8591-9	160 x 100 cm	25.625
MO 8591-10	180 x 100 cm	26.595
MO 8591-11	200 x 100 cm	27.570
MO 8591-12	200 x 108/80 cm	28.945

ADDITIONAL PURCHASE

Product	Price
Bevelled wooden edge instead of ABS-edge	5.835

ACCESSORIES

Item No.	Product	Price
MO 8581	Contact frame extension, height 7,2 cm, per set (4 pcs.)	1.895
MO 8580	Linking device, per piece (2 pcs. per table)	425
MO 1631	Castor, 75 mm, with brake, per castor	860
MO 1630	Castor, 75 mm, without brake, per castor	860
MO 1700	Cable tray in metal, painted black, 49 cm for table length 120-140 cm - hangs between the frame tubes	1.800
MO 1701	Cable tray in metal, painted black, 77 cm for table length 160-200 cm - hangs between the frame tubes	1.800

TRIO



A small cluster of coffee tables, circular, square and rectangular in solid oak or in plywood with all our standard laminate and linoleum colours. The tables are available in six sizes and three heights, making a vast number of combinations possible. Conical legs in solid oak, lacquered or black stained.

WOOD & TREATMENTS



Oak, transparent lacquer
 Oak, natural oil
 Oak, white-oil
 Oak, soap treatment
 Oak, black-stained

LINOLEUM



Pebble 4175 NCS 3502-Y
 Ash 4132 NCS 5502-G
 Black 4023 NCS 9000-N

LAMINATE



Grey U1115 W Duropol NCS S4502-G
 White F7949 Soft white Formica RAL 9016
 Graphite F7837 Graphite Formica RAL8019
 Wood pattern oak F 5374 Elegant oak Formica

TRIO

SPECIFICATIONS & MEASUREMENTS

Description	Trio lounge and coffee tables in a multitude of combination.
Table top thickness	25 mm
Table top	Solid oak with beveled edge, or plywood with linoleum/laminate surface, beveled plywood edge
Table legs	Solid oak

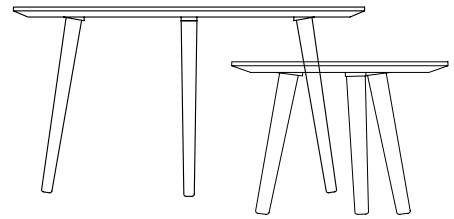

TRIO

Item No.	Size	Price for table top with laminate
MO 9580-1	Ø40 cm (Height: 40/45 cm)	3.060
MO 9580-2	Ø60 cm (Height: 40/45/50 cm)	4.445
MO 9580-3	Ø85 cm (Height: 40/45/50 cm)	6.860
MO 9580-4	110 x 60 cm (Height: 40/45/50 cm)	6.445
MO 9580-5	60 x 60 cm (Height: 40/45/50 cm)	5.095
MO 9580-6	125 x 70 cm (Height: 40/45/50 cm)	8.620

ADDITIONAL PURCHASE

Product	Price
Table top with linoleum	835
Table top with in oak	1.670
Legs and table top/table top surface in black-stained oak	1.585
1 additional leg on Trio tables Ø 60 and Ø 85 cm to have 4 legs	1.995

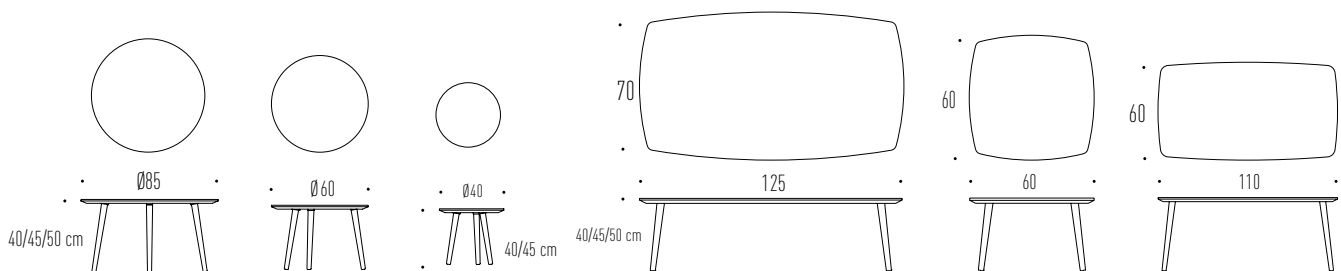

BAR TABLE WOOD

DESIGN: (2018) STRAND & HVASS

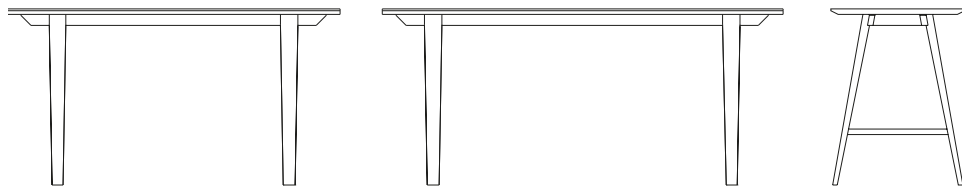

The table combines beautiful woodwork and elegant design with clean lines. The choice of materials contributes to stability and functionality. As the table is available in different sizes, heights and material combinations, it can be used for different purposes e.g. as a meeting table at the modern office or a bar table in restaurants.

WOOD & TREATMENTS



Oak,
transparent
lacquer



Oak, natural
oil



Oak,
white-oil



Oak, soap
treatment



Oak, black-stained

LINOLEUM



Pebble
4175
NCS 3502-Y



Ash
4132
NCS 5502-G



Black
4023
NCS 9000-N

LAMINATE



Grey
U1115 W
Duopal
NCS S4502-G



White
F7949 Soft
white Formica
RAL 9016



Graphite
F7837 Graphite
Formica
RAL8019



Wood pattern oak
F 5374 Elegant oak
Formica

BAR TABLE WOOD

DESIGN: (2018) STRAND & HVASS

SPECIFICATIONS & MEASUREMENTS

Description	Robust long table, counter or bar table height, with beautiful woodwork and clean lines.
Table height	90 cm or 105 cm
Table top	Solid oak, or solid oak with linoleum/laminate
Edge	Beveled edge with transparent lacquer, soap treatment or black-stained
Frame	Solid oak



BAR TABLE WOOD - COUNTER HEIGHT 90 CM

Item No.	Size	Product	Price
MO 8700-1	200 x 80 cm x H90 cm	Laminate	25.520
MO 8700-1	200 x 80 cm x H90 cm	Linoleum	28.200
MO 8700-1	200 x 80 cm x H90 cm	Solid oak	52.360
MO 8700-2	240 x 80 cm x H90 cm	Laminate	27.570
MO 8700-2	240 x 80 cm x H90 cm	Linoleum	30.445
MO 8700-2	240 x 80 cm x H90 cm	Solid oak	56.325

BAR TABLE WOOD - BAR HEIGHT 105 CM

Item No.	Size	Product	Price
MO 8700-3	200 x 80 cm x H105 cm	Laminate	26.720
MO 8700-3	200 x 80 cm x H105 cm	Linoleum	29.400
MO 8700-3	200 x 80 cm x H105 cm	Solid oak	53.560
MO 8700-4	240 x 80 cm x H105 cm	Laminate	28.710
MO 8700-4	240 x 80 cm x H105 cm	Linoleum	31.645
MO 8700-4	240 x 80 cm x H105 cm	Solid oak	57.525

ADDITIONAL PURCHASE

Product	Price
Black-stained frame and edging for tables with linoleum/laminate	2.500
Frame and table top in solid black-stained oak	5.000

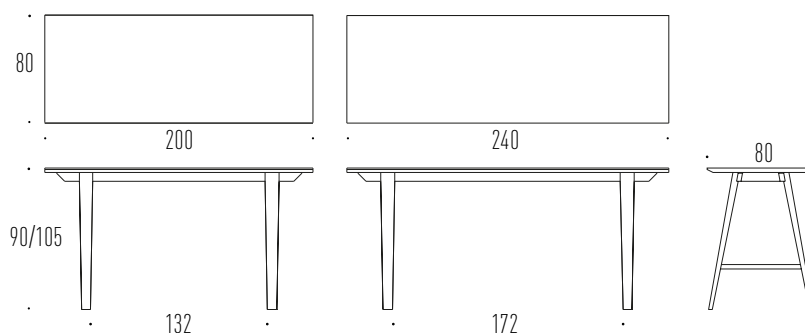

MEETING TABLE

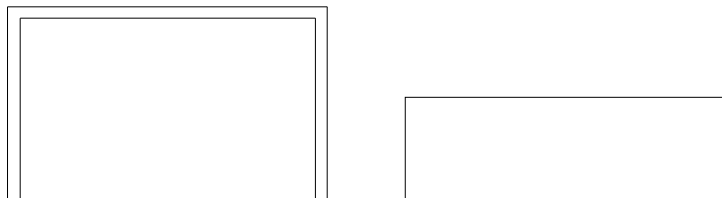

An elegant gable table in a light-weight material - the core of the table top consists of Honeycomb which minimizing material consumption and, at the same time, makes the table light and very strong. Two built-in castors are mounted in one of the gables, so the table can be easily moved to the area where it is to be used. A bar table for many different rooms and particularly useful as a meeting bar table, with the option of both hang-up function for bar chairs and foot rest.

WOOD & TREATMENTS



Oak,
transparent
lacquer



Oak, black-
stained

LINOLEUM



Pebble
4175
NCS 3502-Y



Ash
4132
NCS 5502-G



Black
4023
NCS 9000-N

LAMINATE



Grey
U1115 W
Duropal
NCS S4502-G



White
F7949 Soft
white
Formica
RAL 9016



Graphite
F7837 Graphite
Formica
RAL8019



Wood pattern oak
F 5374 Elegant oak
Formica

MEETING TABLE

SPECIFICATIONS & MEASUREMENTS

Description	An elegant gable table in a light-weight material.
Table top thickness	Table top and gable: 55 mm
Table top and gable	Surface in laminate, linoleum or oak
Details	Two built-in castors are mounted in one of the gables
Sizes	W50-100 x L100-500 x H50-110 cm. For lengths over 250 cm, the table is divided into two and assembled in the middle + has a visible steel rail under the table top.
	Contact the factory for price information for the desired size(s) and executions

MEETING TABLE

Item No.	Sizes	Product	Price
MO 8691-1	160x60xH110	Laminate/Linoleum	28.970
MO 8691-1	160x60xH110	Veneer	31.145
MO 8691-2	200x60xH110	Laminate/Linoleum	33.245
MO 8691-2	200x60xH110	Veneer	35.735

ADDITIONAL PURCHASE

Item No.	Product	Price
	Black-stained oak	2.500

ACCESSORIES

Item No.	Product	Price
	Hang-up pole for Pause bar chair - 160 cm	1.085
	Hang-up pole for Pause bar chair - 200 cm	1.420
	Foot rest - 160 cm	2.325
	Foot rest - 200 cm	2.585

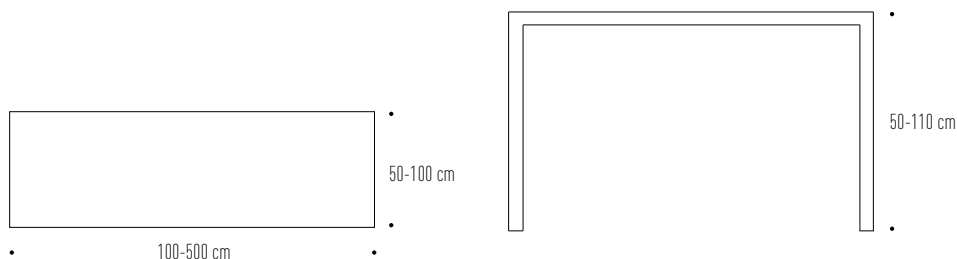

FABRIC, LEATHER & ARTIFICIAL LEATHER

Click on the individual fabric/leather/artificial leather for colours, specifications etc.

PRICE RANGES	ARTIFICIAL LEATHER	WOOL	POLYESTER	TREVIRA CS/FR	GENUINE LEATHER
A		Connect (2) Main Line Plus (3)	Cura (2) Era (3) Medley (2) Quest (3)		
B	Illusion (7) PVC-fri	Atlas (1) Blazer (3) Crisp (2) Fame (2) Focus + Focus Melange (2) Main Line Flax (3) Morph (2) Select (2) Sumi (3) Synergy (3) Remix 3 (1)	Reflect (1)	Go Uni (2) Go Check (2) Go Couture (2) Step (2) Step Melange (2) Relate (1)	
C		Hallingdal 65 (1) Steelcut Trio 3 (1)			
1					Sydney (6) Semi aniline Hero (4) Surface treated
2					Savanne (4) Semi aniline Triumph Crib (4) Surface treated Vacona (6) Aniline

Green letters indicate that the fabric or artificial leather is tested according to one or more of the following: Oeko-Tex®, EU- Ecolabel, Greenguard Certification, Indoor Advantage Gold Certificate. For leather green letters, indicate that the leather is tanned without chrome. Blue letters indicate that the leather is suitable for use in the Care sector.

Suppliers

(1) Kvadrat / (2) Gabriel / (3) Camira / (4) Sørensen Leather / (5) CA-MO Leather/ (6) Nevotex

FABRICS, ARTIFICIAL LEATHER AND LEATHER

Price ranges

The fabrics, as well as the fire-retardant CMHR polyurethane foam with high density: 60 kg/m³, have been chosen in due consideration of the fact that they should be able to withstand many years of hard daily wear regarding abrasion resistance, elasticity and cleaning

1. Abrasion resistance

According to the Technical Specifications from Danish Furnituremakers' Quality Control furniture fabrics used on a firm upholstery, which is on all our seating furniture, should fulfill the requirements of an abrasion resistance of 45.000 rubs according to the Martindale test method when exposed to normal use and 75.000 rubs in cases where the furniture is exposed to severe use as for instance in public environments. For less severe use a minimum of 25.000 rubs is needed.

2. Elasticity

On account of the firm upholstery the fibres in the furniture fabric must have a certain degree of elasticity, i.e. the ability to contract after having been used, in order to avoid wrinkles or puckers which may occur when using cotton fabrics lacking this elasticity. In time leather stretches and wrinkles - more on a thick upholstery than on a thinner back upholstery. The thick leather types stretch less than thin leather.

3. Cleaning

As the major part of our seating furniture has a fixed upholstery, it is important that the furniture fabric is dirt-repellent and stands cleaning throughout a long period of time. This applies to woollen fabrics whereas Trevira CS and cotton fabrics attract dirt. This is why a removable seat cover should be chosen for seating furniture with a Trevira CS fabric in order to make the seat cover washable. Leather must have a surface treatment.

We reserve the right to reject furniture fabrics, vinyls or leather that we find unsuitable for the purpose of the furniture

Steel surfaces

Bright chrome or matt grained lacquer in standard colours at standard price. Powder coating in RAL 9006 aluminium in special colours at an additional price - shown for each product in the price list.



MAGNUS OLESEN ^A/_S

SHOWROOM

FREDERIKSGADE 7, ST. TH.
1265 KØBENHAVN K, DENMARK

FACTORY

AGERTOFT 2, DURUP
7870 ROSLEV

