

In addition to standard versions of the table ranges, a variety of customized options are available. Forms, dimensions, surfaces and prices on request.

Additional elements: Left or right always refers to the direction sat in.



Surfaces


Veneered table tops and wood frames on seating are always protected with clear varnish. Colored metal surfaces are coated with powder varnishes that are free of heavy metals.

Upholstery

All foam used is CFC-free.

Symbols

 Total height
 Seating height

 Total width
 Seat width

 Total depth
 Seat depth

 Veneer direction

 Decor direction

 Sitting direction

The seating height is established under load with DIN testing equipment. The total height, width and depth are the minimum dimensions.

Some of the accessories are shown slightly larger to make them clearer.

Important information / typical product characteristics

Shine

Shine refers to impressions on the cover which can occur due to pressure, body heat and moisture. The form in which it manifests itself depends on the model, materials and upholstery technique and it is one of the characteristics of the design concerned. Therefore it is not a sign of poor quality.

Leather production

Leather is a natural product. Each leather hide is unique. Insect bites, chafed areas or scars are part of the hide's history. They indicate the natural origin and high quality of the material and are therefore not recognized as a justified cause for complaint.

Wood

Wood is a natural product. We only use carefully selected and high-quality wood and genuine wood veneers for our product ranges. Typical characteristics like small knots are signs of natural growth. Because each tree trunk is unique, differences in the structure and color are also possible. The unique surface characteristic of wood is natural and therefore not accepted as justified grounds for a complaint.

Indoor and outdoor furniture

The models are suitable for outdoor use. Nevertheless, we recommend not over-exposing this furniture to the effects of sun, rain, dust and wind and to keep it in a dry and well-aired place when not using.

Differences in color / structure

The combination of different materials, such as chrome plating, or varnishing of aluminum, steel or plastic can lead to differences in the color and structure when the surfaces are compared. These differences do not constitute grounds for complaint.

The RAL/Pantone color info is approximate. Any differences in color do not constitute grounds for complaint.

As regards our upholstery materials and laminates, despite selecting them carefully, there can be slight differences in color which are due to the batch they are produced in. When textiles are made from recycled materials, the colors and textures may be fluctuate more for production reasons. This is a result of our pre-suppliers' manufacturing processes and therefore not recognized as a justified reason for complaint.

SENAB

Färgmarkeringar och/eller symboler för hållbara alternativ i prislistan:

Mörkgrön markering eller symbol

Miljömärkt produkt – Möbler där hela den sammansatta varan har en typ 1 miljömärkning enligt ISO 14024 med Svanen, Möbelfakta, EU Ecolabel eller annan likvärdig märkning.

Ljusgrön markering eller symbol

Hållbarhetsmärkt produkt eller beståndsdel – Möbler där hela eller delar av den sammansatta varan är hållbarhetsmärkt, exempelvis med FSC, EU Ecolabel eller OEKO-TEX®. Leverantören ska kunna ge mer detaljerad information om vilka delar eller variationer som är hållbarhetsmärka vid begäran.

Orange markering eller symbol

Klimatberäknad produkt – Produkt med dokumenterad miljövarudeklaration (EPD) enligt ISO 14025.

Lila markering eller symbol

Produkt med återvunnet eller förnybart material (enligt definitionerna i ISO 14021). Leverantören ska kunna ge information om andel (%) återvunnet och/eller förnybart (biobaserat) vid begäran. Märkning av återvinningsbart material utgår.

Blå markering eller symbol

Demonterbar produkt – Produkt som är demonterbar till olika komponenter och beståndsdelar som i första hand möjliggör återbruk och i andra hand materialåtervinning när produkten nått sin fulla livslängd. Produkten ska vara designad för renovering, det vill säga att det ska vara enkelt att reparera och byta ut moduler, komponenter och beståndsdelar som slits över tid. Exempelvis ska ytskikt, som bordsskivor, textil och stoppning kunna tas isär, avlägsnas och ersättas med hjälp av vanligt förekommande manuella verktyg, ej specialverktyg. Enklare reparationer och utbytesarbeten ska kunna utföras av en lekman. Om det krävs fackmanakunskap för mer avancerade arbeten ska det framgå av anvisningarna som leverantören ska kunna ge vid begäran. Anvisningarna ska innehålla en sprängskiss, steg för steg beskrivning inklusive vilka verktyg som krävs samt hur möbelns ingående delar bör källsorteras.

Price List 2024



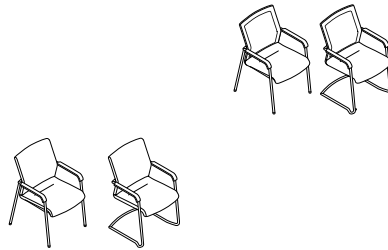
Content according to ranges

Upholstery material

8

170 Range – 0N

22



20 Range – Stitz 2

54



202 Range – Stand-up

56



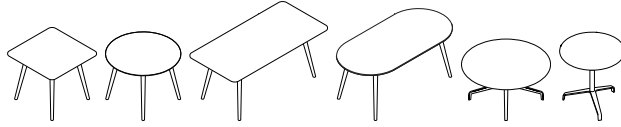
222 Range – Occo

58





222 Range – Occo



78

290 Range – Sola



80

296 Range – Decide



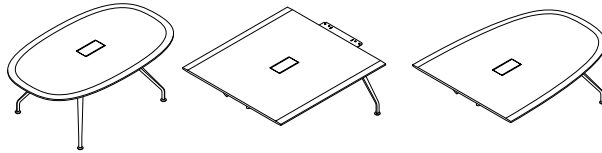
82

30 Range – Graph



86

300 Range – Graph tables



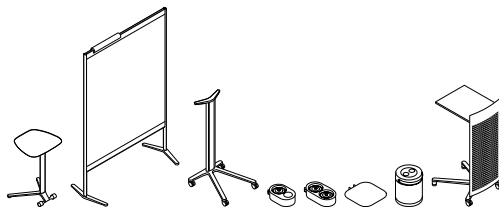
94

320 Range – Yonda



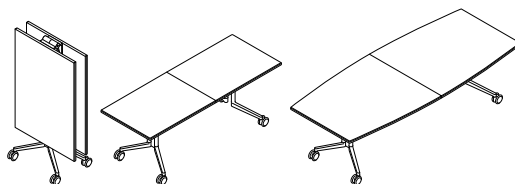
106

440 Range – Confair



118

440 Range – Confair folding table

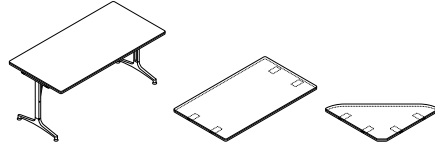


118



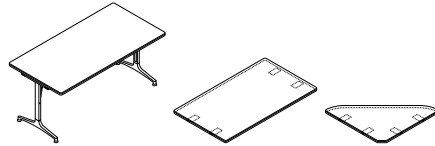
460 Range – mAx

130



465 Range – mAx light

136



610 Range – Timetable

148



612 Range – Timetable Smart

152



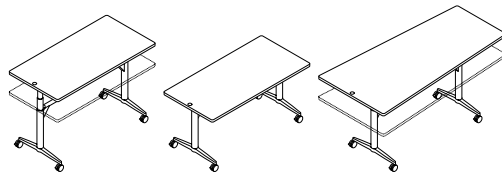
614 Range – Timetable Shift

168



615 Range – Timetable Lift

184



Built-in component set range

194

Edging matrix

296



Content in alphabetical order

AT	187 Range	44
Confair	440 Range	118
Confair folding table	440 Range	118
Decide	296 Range	82
Graph	30 Range	86
Graph tables	300 Range	94
IN	184 Range	38
mAx	460 Range	130
mAx light	465 Range	136
ME	164 Range	14
Occo	222 Range	58
ON	170 Range	22
Sola	290 Range	80
Stand-up	202 Range	56
Stitz 2	20 Range	54
Timetable	610 Range	148
Timetable Lift	615 Range	184
Timetable Smart	612 Range	152
Yonda	320 Range	106



Upholstery material

34 / Vivid Description

80% post-consumer recycled polyester
20% elastomer
320 g/lin. m
width 140 cm (55")
Test results
Abrasion resistance:
100,000 rubs,
BS EN ISO 12947-2 (Martindale)
Lightfastness:
6-8, BS EN ISO 105-B02 method 2
Pilling:
5, BS EN ISO 12945-2
Fastness to rubbing:
Dry 4-5, wet 4-5
EN ISO 105-X12
Flame resistance:
CA TB 117-2013
BS EN 1021-1
BS EN 1021-2
BS 5852 Part 1
Cleaning
Permanent covers:
Vacuum regularly,
have dry cleaned
Replaceable covers:

Colors

35 / Fiberflex (Runner)

Description
100% polyester
510 g/lin. m,
width 160 cm (63")
Test results
Abrasion resistance:
70,000 rubs,
BS EN ISO 12947-2 (Martindale)
Lightfastness:
5-7, BS EN ISO 105-B02 method 2
Pilling:
5, BS EN ISO 12945-2
Fastness to rubbing:
Dry 4-5, wet 4-5
EN ISO 105-X12
Flame resistance:
CAL 117 E
EN 1021-1 if mounted on CMHR
foam 35 kg/m³ min.,
EN 1021-2 if mounted on CMHR
foam 50 kg/m³ min.
Cleaning
Vacuum regularly, have dry
cleaned.

37 / Racer Description

100% polyester
440 g/lin. m,
width 170 cm
Test results
Abrasion resistance:
90,000 rubs,
BS EN ISO 12947-2 (Martindale)
BS EN 14465
Lightfastness:
5-7, BS EN ISO 105-B02 method 2
Pilling:
4-5, BS EN ISO 12945-2
Fastness to rubbing:
Dry 4-5, wet 4-5
EN ISO 105-X12
Flame resistance:
CAL 117 E
BS 476 Part 7, ASTM E 84,
EN ISO 1021 1+2,
EN 1021-1 if mounted on CMHR
foam 35 kg/m³ min.,
EN 1021-2 if mounted on CMHR
foam 50 kg/m³ min.
Cleaning
Vacuum regularly, have dry
cleaned

38 / Era Description

100% polyester
448 g/lin. m,
width 140 cm
Test results
Abrasion resistance:
100,000 rubs,
BS EN ISO 12947-2 (Martindale)
Lightfastness:
5, BS EN ISO 105-B02 method 2
5-7, depending on the colour,
BS EN ISO 105-B02 method 2
Pilling:
low
Fastness to rubbing:
Dry 4, wet 4
EN ISO 105-X12
Flame resistance:
on request
Cleaning
Permanent covers:
Vacuum regularly,
have dry cleaned
Replaceable covers:

41 / Formstrick Description

100% polyamide hybrid
750 g/m²
Test results
Abrasion resistance:
200,000 rubs,
BS EN ISO 12947-2 (Martindale)
Lightfastness:
6, BS EN ISO 105-B02 method 2
Pilling:
5, BS EN ISO 12945-2
Fastness to rubbing:
Dry 5, wet 5
EN ISO 105-X12
Flame resistance:
DIN EN 1021 1+2
Cleaning
Vacuum regularly, have dry
cleaned.
If it's very damp, the elasticity of
the Formstrick can slightly
slacken, but will regain its
original shape when it dries.

47 / Nova Description

100% polyester
560 g/lin. m,
width 140 cm
Test results
Abrasion resistance:
50,000 rubs,
BS EN ISO 12947-2 (Martindale)
Lightfastness:
5-7, BS EN ISO 105-B02 method 2
Pilling:
5, BS EN ISO 12945-2
Fastness to rubbing:
Dry 4-5, wet 4-5
EN ISO 105-X12
Flame resistance:
CAL 117 E,
EN 1021-1 if mounted on PUR foam
22 kg/m³ min.,
EN 1021-2 if mounted on CMHR
foam, 36 kg/m³ min.
Cleaning
Permanent covers:
Vacuum regularly, have dry
cleaned
Replaceable covers:

51 / Oceanic Description

100% recycled, post-consumer
polyester with 50% SEAQUAL
yarn.
497 g/m²
width 140 cm
Test results
Abrasion resistance:
100,000 rubs,
BS EN ISO 12947-2 (Martindale)
Lightfastness:
5, BS EN ISO 105-B02
Fastness to rubbing:
Dry 4, wet 4
EN ISO 105-X12
Flame resistance:
EN 1021 1&2 (CMHR)
BS 7176 LH (CMHR)
BS 7176 MH (CMHR+treatment)
Cleaning
Vacuum regularly, have dry
cleaned

54 / Pitch (Step, Step Melanche) Description

100% Trevira CS
470 g/lin. m,
width 140 cm
Test results
Abrasion resistance:
100,000 rubs,
BS EN ISO 12947-2 (Martindale)
Lightfastness:
5-7, BS EN ISO 105-B02 method 2
Pilling:
4-5, BS EN ISO 12945-2
Fastness to rubbing:
Dry 4-5, wet 4-5
EN ISO 105-X12
Flame resistance:
CAL 117 E,
DIN 4102-1 B1,
NF P 92-503-507 M1,
ÖNORM A 3800-1,
B1/Q1/TR1,
BS 5852 if mounted on CMHR
foam,
EN 1021-1/-2 if mounted on PUR
foam min. 30 kg/m³,
UNI VF 9175 11M if mounted on
CMHR foam.
Cleaning
Permanent covers:
Vacuum regularly, have dry
cleaned
Replaceable covers:



56 / Cyber

Description

100 % post-consumer, recycled polyester
570 g/lin. m,
width 140 cm

Test results

Abrasion resistance:
120,000 rubs,
BS EN ISO 12947-2 (Martindale)
Lightfastness:
7-8, BS EN ISO 105-B02
Pilling:
4-5, BS EN ISO 12945-2
Fastness to rubbing:
Dry 4-5, wet 4-5
EN ISO 105-X12
Flame retardancy:
EN 1021 1&2 (CMHR)
CA TB 117-2013
Flame retardancy depends on the foam used.

Cleaning

Permanent covers:
Vacuum regularly,
have dry cleaned
Replaceable covers:

58 / Evida

Description

approx. 50 % renewable raw materials
approx. 30 % natural raw materials
approx. 20 % petroleum-based raw materials
750 +/- 50 g/m²
width 137 cm

Test results

Abrasion resistance:
150,000 rubs,
DIN EN ISO 5470-2 (Martindale)
meets the German Medical Product Act
DIN EN ISO 10993-5+10
Flame resistance:
DIN EN 1021-1+2,
BS 5852 Crib 0+1,
CA TB 117-2013,
flame retardancy depends on the foam used.

Cleaning

Please remove any soiling immediately (use warm, mild soapy water, a microfiber cloth and soft brush).
Please don't use solvents.

60 / Blend (Blazer)

Description

100% virgin wool
645 g/lin. m,
width 140 cm

Test results

Abrasion resistance:
50,000 rubs,
BS EN ISO 12947-2 (Martindale)
Lightfastness:
5, BS EN ISO 105-B02
Pilling:
3-4, BS EN ISO 12945-2
Fastness to rubbing:
Dry 4, wet 4
EN ISO 105-X12
Flame resistance:
EN 1021-1,
EN 1021-2
BS 7176 Low Hazard
NF D 60-013
ÖNORM B 3825 & A 3800-1 (58kg/m³ CMHR Foam)
UNI 9175 Class 1 IM
BS 476 Part 7 Class 1
EN 13501-1 Adhered Class D, s1, d0
Please state when ordering:
BS 5852 Ignition Source 5 if treated with flame retardants;
BS 7176 Medium Hazard if treated with flame retardants;
BS 476 Part 6 Class 0 if treated with flame retardants;
EN 13501-1 Adhered Class B, s1, d0 wenn mit FR ausgerüstet;
EN 13501-1 Unadhered Class D, s2, d0 if treated with flame retardants;
BS 5867-2: Type B Curtains & Drapes if treated with flame retardants
Cleaning
Permanent covers:
Vacuum regularly, have dry cleaned
Replaceable covers:

64 / Morph

Description

85% New Zealand wool
15% polyamide
475 g/lin. m,
width 140 cm

Test results

Abrasion resistance:
200,000 rubs,
BS EN ISO 12947-2 (Martindale)
Lightfastness:
5-6, BS EN ISO 105-B02
Pilling:
4, BS EN ISO 12945-2
Fastness to rubbing:
Dry 4-5, wet 4-5
EN ISO 105-X12
Flame resistance:
EN 1021 1&2
BS 5852 Part 1
BS 5852 Crib 5 (CMHR)
CA TB 117-2013
Flame retardancy depends on the foam used.
Cleaning
Vacuum regularly, have dry cleaned

65 / Re-wool

Description

45% recycled wool, 45% virgin wool, worsted, 10% nylon
540 g/lin. m,
width 140 cm

Test results

Abrasion resistance:
approx. 100,000 rubs,
BS EN ISO 12947 (Martindale)
Lightfastness:
5-7, BS EN ISO 105-B02
Fastness to rubbing:
Dry 5-7, wet 4-5
EN ISO 105-X12
Flame resistance:
EN 1021 1&2
BS 5852 Part 1
BS 5852 ignition source 3 (CMHR)
BS 5852 Crib 5 (CMHR+treatment)
NF D 60-013 (CMHR)
UNI 9175 Class 1 | M (CMHR)
ÖNORM A 3800-1 B1, Q1
CA TB 117-2013
Cleaning
Vacuum regularly, have dry cleaned

66 / Lona (Lano)

Description

85 % virgin wool, 15 % polyamide
520 lin. m
width 140 cm

Test results

Abrasion resistance:
150,000 rubs,
BS EN ISO 12947-2 (Martindale)
Lightfastness:
5-7, BS EN ISO 105-B02 method 2
Pilling:
4, BS EN ISO 12945-2
Fastness to rubbing:
Dry 4-5, wet 4-5
EN ISO 105-X12
Flame resistance:
EN 1021-1/-2 if mounted on PUR foam, 22 kg/m³ min.,
BS 7176 medium hazard if mounted on CMHR foam 35 kg/m³ min.,
ÖNORM A 3800-1 Q1,
ÖNORM B 3852 flame retardant if mounted on PUR foam B2,
CAL 117 E
Cleaning
Permanent covers:
Vacuum regularly, have dry cleaned.

Because of pilling, the Lona fabric might require more cleaning.
Replaceable covers:

68 / Kvadrat Remix

Description

90 % virgin wool, worsted
10 % nylon,
415 g/lin. m,
width approx. 138 cm (54")

Test results

Abrasion resistance:
approx. 100,000 rubs,
BS EN ISO 12947-2 (Martindale)
Lightfastness:
6, BS EN ISO 105-B02 method 2
Pilling:
4, BS EN ISO 12945-2
Fastness to rubbing:
Dry 4, wet 4
EN ISO 105-X12
Flame resistance:
EN 1021 1&2
BS 5852 Part 1
BS 5852 Crib 5 (CMHR + treatment)
NF D 60-013 (CMHR)
UNI 9175 1IM (CMHR)
ÖNORM B1/Q1
CA TB 117-2013
Flame retardancy depends on the foam used.
Cleaning
Cleaning permanent covers:
Vacuum regularly, have dry cleaned.
Replaceable covers:



600 / Hush Stripe 40

Description

80% polyester, 20% viscose
290 g/lin. m
width 170 cm

Test results

Lightfastness:
5-7, BS EN ISO 105-B02
Fastness to rubbing:
Dry 4-5, wet 4-5
EN ISO 105-X12

Flame resistance:
BS 476 Part 7, class
ASTM E 84 class 1+2

Cleaning

Vacuum regularly

91 / Kvadrat Steelcut Trio

Description

90% virgin wool,
worsted 10% nylon,
770 g/lin. m,
width approx. 140 cm

Test results

Abrasion resistance:
approx. 100,000 rubs,
BS EN ISO 12947-2 (Martindale)
Lightfastness:

5-7, BS EN ISO 105-B02 method 2

Pilling:

4, BS EN ISO 12945-2

Fastness to rubbing:

Dry 4-5, wet 3-5

EN ISO 105-X12

Flame resistance:

when ordering, please state

EN 1021-1/2

BS 5852 part 1 DIN 4102 B2

Önorm B1/Q1

NF D 60 013

UNI 9175 11M

US Cal. Bull. 117, – 2013

NFPA 260 AS/NZS 3837

IMO FTP Code 2010:

Part 8

B2 and Crib 5 and SN

198 898 5.3 for flame retardant

finishes.

Cleaning

Permanent covers:
vacuum regularly, have dry
cleaned.

Replaceable covers:

92 / Credo

Description

95% virgin wool
5% polyamide
870 g/lin. m
width 140 cm

Test results

Abrasion resistance:
100,000 rubs,
BS EN ISO 12947-2 (Martindale)
Lightfastness:

min. 5-8, BS EN ISO 105-B02
method 2

Pilling:

min. 4-5, BS EN ISO 12945-2

Fastness to rubbing:

dry 5, wet 4-5

EN ISO 105-X12

Flame resistance:

please state when ordering,
FAR 25.853 (12 seconds vertical)

CAL TB 117-2013

DIN 4102-1 B2

EN 13501-1

EN 1021-1 and -2

BS 5852:1979 (part 1)

BS 5852:2006 (part 2) Crib5

BKZ: 5.3 SN 198898

UNI 9175 (1 IM)

NF P92 503-507 M2

IMO: 2014/90/EU marine

equipment directive

Cleaning

Permanent covers:

Vacuum regularly, have dry
cleaned

Replaceable covers:

Information

Fabrics and leather sent in

Wilkhahn provides no guarantee
for fabrics and leathers
submitted that come from fabric
manufacturers whom it has no
supplier agreement with. Please
note that we require a cover
material sample of at least
DIN A4 in size to check whether
we can use it.

74 / Leather

Description

Cowhide for furniture with
tolerances in terms of color and
texture, compliant with DGM,
RAL GZ 430.

Test results

Lightfastness:

6-7, BS EN ISO 105-B02 method 2

Flame resistance:

California TB 117 E BS 5852-3

when mounted on PUR foam 22

kg/m³ min.,

EN 1021-/-2 when mounted on

PUR foam 22 kg/m³ min.

Cleaning

Remove any soiling with a damp,
absorbent cloth and rub over the
whole area with a dry woolen
cloth immediately.

87 / Leather

Description

Particularly high-quality, pure
aniline-dyed cowhide leather,
which reveals natural
irregularities or subsequent
shine.

Test results

Lightfastness:

(WBS level) >3 compliant with

DIN EN ISO 105-B02

Flame resistance:

DIN 75200 and DIN EN 1021

part 1 + 2,

CE 117 E

Cleaning

Carefully remove any soiling with
a slightly damp, absorbent cloth
and immediately rub all over with
a dry woolen cloth.

Information

Leather characteristics

Leather is a natural product.

Each leather hide is unique.

Insect bites, chafed areas or

scars are part of the hide's

history. They indicate the natural

aspect and high quality of the

material and are therefore not

recognized as a justified cause

for complaint.

Felt

Description

100 % wool,
with non-slip coating,
Felt thickness 5 mm
1,5 kg/sq m

Test results

Abrasion:

0.4 to 0.5 g/50 cm³,

DIN 53863 T2

Lightfastness:

5, BS EN ISO 105-B02 method 2

5-7, depending on the colour,

BS EN ISO 105-B02 method 2

Pilling:

low

Flame resistance:

on request

Cleaning

Permanent covers:

Vacuum regularly,

have dry cleaned

Replaceable covers:

Information

Felt characteristics

Felt is a natural product.

Therefore, there can be

differences in the color. These

differences are not a justified

reason for complaint but

underscore the material's

uniqueness.



Wilkhahn and sustainability

In over 100 years of its corporate history, Wilkhahn can look back on a sustainability philosophy that has grown over decades. Aspects such as durability, social fairness, environmental responsibility and cultural orientation have been evolving as corporate principles since the 1950s. Wilkhahn today is regarded internationally as a model of excellence, not only on account of its products but also because of its modern corporate philosophy. This is because the company realized early on that sustainable design should embrace environmental aspects, improve social relationships and define the cultural role of a company. This approach to the way we do business creates a bond between us and our customers throughout the world. There is surely no more rewarding task than working together for a successful future that is worth living in.

Corporate principles

We believe in the power of good design.

Which is why we're passionate about sustainable office furnishings worldwide that boost health, foster well-being and creativity and empower people to do their jobs well.

Good communication is the key to encouraging creativity and productivity.

We develop, produce and market pioneering, superbly designed, high-quality office chairs and tables.

Form and function on an equal footing.

The Wilkhahn brand stands for first-class product quality, highly innovative ergonomics, and pioneering design.

We set ground-breaking trends.

Which is why innovations at Wilkhahn start by thinking outside the box. A product development isn't about a new chair per se, but better dynamic sitting, not about a new table, but nurturing communication, not about a new sofa, but coming together with other people and relaxing.

We pass knowledge on.

Because knowledge is the future's most important commodity. As a company, our competitive edge is underpinned by our workforce's expertise. Which is why we see learning as a personal

development opportunity. And we share that expertise in the company and with business partners to build on our joint success.

We provide products and service in impressive quality.

The whole is more than the sum of its parts – but it's the quality of all the details that governs the quality of the finished product or service. Which is why providing excellence that covers the whole spectrum of issuing quotes, producing and shipping our products is one of the core brand values and is evident in every product and process and every encounter with the brand.

We understand the changes in workplaces and offer our customers solution-driven support.

Wilkhahn customers buy the added value and benefits associated with our products and services. To spot new trends and requirements, we keep our finger on the pulse. We examine our customers' needs in detail to provide impressive solutions.

Simply the best.

We take responsibility and help shape the future.

We operate a policy of fairness towards each other and our suppliers, customers, and the environment. The combination of business success, socio-ecological responsibility and involvement in cultural activities makes us an exemplary company worldwide that we continue to develop sensitively.

Sustainability policy

UN Global Compact

Wilkhahn joined the United Nations Global Compact initiative in 2007. The company commits itself to the ten principles of Global Compact regarding the protection of international human rights, adherence to labor standards and rights for employees,

the protection of the environment and anti-corruption, all of which are specified as binding corporate policy.



WE SUPPORT

ISO 9001:2015 quality management system

In order to safeguard and continually optimize the high quality of products and processes at Wilkhahn, a comprehensive quality management system was set up as early as 1996. Since then it has been certified for compliance with the ISO 9001 Quality Management Standard of the International Standardization Organization. Quality management is all about customer focus, management responsibility, the participation of all employees involved, ensuring and improving process safety and supplier relations.



ISO 14001:2015 environmental management system

Wilkhahn is also certified to the ISO 14001 international environmental management standard, which defines globally recognized requirements for environmental management systems, such as environmental performance indicators and environmental performance assessments.

EMAS

EMAS is the acronym for EcoManagement and Audit Scheme, developed by the European Union. As a combined environmental management and auditing system, its purpose is to verify companies are improving their environmental performance. At the north German headquarters in Bad Münden, Wilkhahn has been regularly certified based on the latest version of EMAS since 2001. In the environmental statement, confirmed by annual audits, Wilkhahn gives a public account of the company's environmental performance. The printed version of the environmental statement can

be ordered at www.wilkhahn.com/ service. Detailed ecological product information on each of the products is also available to download.



FSC

The Forest Stewardship Council® (FSC) quality label indicates compliance with stringent socio-ecological requirements in terms of forest management and trading wood products. Wilkhahn's Bad Münden headquarters meet the criteria of the Forest Stewardship Council (FSC) and are entitled to process and sell FSC®-certified products (license code C118389, certificate no. TUEV-COC-000462).



Das Zeichen für verantwortungsvolle Waldwirtschaft

Product certification

Wilkhahn office furniture ranges are not only certified according to international testing and inspection standards regarding product safety and functional integrity. They also meet all key international reference systems for highly health-compatible and environmentally friendly products.

GREENGUARD™

Virtually all Wilkhahn ranges undergo GREENGUARD testing and certification. The Greenguard Environmental Institute is an independent institution in the US that primarily certifies products with regard to their suitability for interiors. Besides environmental



aspects, special focus is placed on ensuring that products do not emit any pollutants that might be harmful to health.



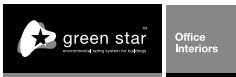
LEED

Leadership in Energy and Environmental Design (LEED) is a rating system used by the US Green Building Council to evaluate the environmental and social compatibility of buildings. LEED certification awards extra credit points if Wilkhahn office chair and table ranges are used.



Green Star

Green Star is an extensive, voluntary rating system developed by the Australian Green Building Council. The system assesses how ecological a building's design is. The system uses various categories to rate any potential ecological impact resulting from a location chosen for a project, the way the project is carried out, managed or its design.



FISP

The UK Furniture Industry Sustainability Program (or FISP for short) wants to foster effective environmental protection, social progress, careful usage of natural resources, economic growth and employment. FISP was developed by the British Furniture Industry Environment Committee (FIEC) whose members include key trade associations and furniture

manufacturers. Since 2006, FISP has developed into an international network of over 60 members, one of whom is Wilkhahn.



Responsibility from the very start

In the design and development process, ecological impact is also taken into consideration in addition to design, functional and business-related aspects. Because these factors play a pivotal role in the materials chosen, manufacturing processes, options regarding assembly, logistics and transport and how easy products are to repair or recycle. This overview shows the key aspects for the entire product life cycle that currently apply at Wilkhahn.

Materials

The materials used are subject to stringent controls. Prohibited chemicals are not used in our products at all. All feedstock is listed in a register of hazardous substances. This helps to minimise the use of or substitute any potentially harmful materials. With the goal being to achieve maximum durability and quality, some recycled materials are used in the production of Wilkhahn ranges. This applies in particular to metals like steel and aluminum.

Production

Water conservation, waste management and sustainable energy production

Water is becoming an increasingly important resource. Wilkhahn spares no effort in minimizing water consumption in all areas. By treating process water, recycling and using state-of-the-art varnishing machinery, no waste water is produced that requires monitoring. The Wilkhahn waste management concept includes sorting waste selectively, as well as recycling and disposing of all waste fractions resulting from the production and management departments. The continual decrease of energy consumption is an important goal of the environmental management system. A combined heat and power plant and connection to a biogas plant at the Bad Münden site have more than

doubled energy efficiency. As a result, heating at the headquarters and production facilities is CO₂ neutral.

Wilkhahn production sites

Wilkhahn products are produced or assembled at the Bad Münden (Germany) and Sydney (Australia) sites. The branch facilities and the international subsidiaries are not only subject to quality management requirements, but also to guidelines for the socio-ecological focus of corporate policy which apply through the entire company.

Product utility

Aesthetics and design

Sustainable products must be practical. The Wilkhahn ranges are timeless, with useful, intuitive-to-use functions and come in durable materials. A standard that is reflected in every single detail. The Wilkhahn design approach therefore results in an increase in the utility value of a product that is destined to last.

Durability and guarantee

The ranges set standards for product design that is sustainable in the best possible sense of the word. The durability of the high-quality materials, the innovative functionality and the traditional, understated design guarantee our furniture will last for decades. We give a five-year manufacturers' guarantee, allowing customers to plan reliably (refer to the relevant guarantee policy for details). An issue we feel responsible for, regardless of our products' long useful lives. We consider guarantees way beyond these periods as selling the future short. Our services to extend the ecological life of the furniture include maintenance as well as an overhaul of older ranges. Wilkhahn guarantees it will carry out repairs on discontinued furniture for at least two years after production has ceased.

End of the product life cycle

Product take-back and recycling

Even after the product has reached the end of its life, we still feel responsible and offer our customers extensive take-back and recycling services. We guarantee to take back all products that are no longer in use. Wilkhahn products are dismantled in the factory, all parts are selectively sorted in terms of their inherent materials and then recycled. By labeling the materials, ensuring

they're non-toxic and easy to dismantle, we're already making sure today that the components in Wilkhahn products can be incorporated into local material and production cycles and be properly recycled and disposed of.

Disassembly and recycling

Most of Wilkhahn's product components are suitable for non-destructive disassembly. To ensure that materials can be sorted according to type, all components weighing more than 150 g come with a label that is valid across the world. No agents to protect materials or organic halogen compounds are used which would prevent subsequent recycling.

170 Range ON®

Design: wiege



Technical details

Function

Task chairs with Trimension®, synchronous, three-dimensional kinematics to encourage three-dimensional dynamic sitting. The perfect interaction of the synchro-adjustment mechanism, seat and backrest automatically adapts to any posture the user adopts. The supporting counter pressure is quickly and precisely adjustable in any direction (4.5 rotations max.) for people weighing from 45 to 120 kg. The backrest height is adjustable by up to 60 mm in six lockable positions. The backrest and seat can be locked in the front sitting position. The seating height is precision adjustable between 400 mm and 520 mm at the touch of a button with a DIN 4550-compliant gas lift. All models are optionally available with seat-depth extension of 400 to 450 mm. (The height of the counter chairs is precision adjustable between 680 mm and 810 mm). Meeting/visitor chairs with Trimension, on request, available with swivel-mounted column, not height adjustable, alternatively as a four-leg variant or cantilever chair, optionally stackable.

Frame

Task chairs and counter stool

Five-star base, optionally made of black through-dyed plastic or die-cast aluminum, coated (black, black with a textured matte finish, white with a textured matte finish, or in a silver satin finish), polished or bright chrome-plated. Twin-wheel swivel casters with load-dependent braking, made of black or white polyamide compliant with DIN EN 12529 as the standard version for carpets; with gray soft polyurethane tire for hard floors. The casters are optionally electrically conductive. Swivel arms made of die-cast aluminum, coated (black or black with a textured matte finish, or white with a textured matte finish, or silver satin finish), polished or bright chrome-plated. Mechanism shell made of blasted die-cast aluminum, optionally coated black, or white with a textured matte finish or with a silver satin finish, with a top cover made of black or white through-dyed polypropylene. The gas lift is covered by a telescopic protective tube made of black or white through-dyed polypropylene.

Task chairs	Frame	Star base	Swivel arms	Mechanism shell
		50 Plastic	Silver satin finish, coated black or black with textured matte finish	Shot-blasted aluminum, silver satin or black coated
		51 Bright chrome-plated	Silver satin finish, coated black or black or white with textured matte finish or with bright chrome plating	Shot-blasted aluminum, silver satin, black or white textured matte coated
		52 Polished aluminum	Polished aluminum or coated white with a textured matte finish	Shot-blasted aluminum, silver satin, black or white textured matte coated
		53 Coated black (RAL9011)	Coated black or black with textured matte finish	Shot-blasted aluminum
		60 Coated with a silver satin finish (RAL9006)	Coated with a silver satin or white with a textured matte finish	Shot-blasted aluminum, silver satin, black or white textured matte coated
		90 Coated with a black textured matte finish (RAL9011)	Coated with a black textured matte finish (RAL9011)	Shot-blasted aluminum
		91 Coated white with a textured matte finish (RAL9016)	Coated white with a textured matte finish (RAL9016)	Coated white
	Armrests	Height adjustment	Depth adjustment	Swivel
		3-D 100 mm	40 mm	30°
Visitor chairs	Frame	Round steel tubing frame		
		51 Bright chrome-plated		
		91 Coated white with a textured matte finish (RAL9016)		
		90 Coated with a black textured matte finish (RAL9011)		
Cantilever chair	Frame	Round steel tubing frame		
		51 Bright chrome-plated		
		91 Coated white with a textured matte finish (RAL9016)		
		90 Coated with a black textured matte finish (RAL9011)		
Small components	Casters, glides, frame components, adjustment levers			
	40 Black plastic		Plastic black	Black
	40 White plastic		Plastic gray	Black or white

Awards



Bundespreis
ecodesign
Produkt 2012



mixology¹⁰





Counter stool with extra height-adjustable foot ring, bright chrome-plated, with lock screw to affix it and twin-wheel swivel casters with load-dependent braking.

24-hour chairs

All have a die-cast aluminum star base with extra swivel arm supports, with a modified synchro-adjustment mechanism and exceptionally hard-wearing covers from Wilkhahn's fabric and leather collection. Designed for people weighing up to 120 kg, the models consequently comply with the DIN EN 1335 standard requirements for 24-hour use.

Visitor/conference chairs

Four-star base made of die-cast aluminum, coated (black, black with a textured matte finish or silver satin finish), polished or bright chrome-plated. Black, multipurpose glides made of plastic for all types of flooring. Swivel arms made of die-cast aluminum, coated (black or black with a textured matte finish or silver satin finish), polished or bright chrome-plated. Mechanism shell made of die-cast, shot-blasted aluminum, optionally coated in black or with a silver satin finish, with top cover made of black, through-dyed polypropylene. The gas lift is covered by a telescopic protective tube made of black, through-dyed polypropylene.

Cantilever chair

Frame made of tubular steel (bright chrome-plated tubular steel, black or white coating with a textured matte finish), 22 mm in diameter, optionally with anti-tilt stopper made of black or white polyamide as the standard version for carpets, with extra glides for hard flooring, with felt inserts on request.

Four-leg visitor chair

Frame made of tubular steel (bright chrome-plated, black or white coating with a textured matte finish), leg diameter 22 mm. Models 176/7 and 176/71 with multipurpose, POM (polyoxymethylene) glides in black for soft and hard floorings.

Seat

Task, visitor, and conference chairs

Very elastic, flexibly suspended seat shell with seat upholstery panel made of black or white, through-dyed polypropylene, polyurethane seat cushioning covered in the same material as the backrest cover in Fiberflex, or fabric. The seat is replaceable. All models optionally have seats with soft padding (with extra cut foam and facings at the sides). In models with management grade upholstery (174/71, 175/71, 171/71), seat cushioning also with extra padding and side facings, optionally covered in leather too. Optionally with seat-depth extension from 400 to 450 mm (all types of upholstery).

Model 175/73 with soft padding, as well as color-contrasting double seams and contour stitching. Seat cushioning with side facings.

Task chair models 174/7, 174/72, 175/7, 175/72, 174/71, 175/71 optionally with a constant 6-degree tilt. Permanent comfort tilt (6°) not combinable with a white version.

Backrest

Task, visitor, and conference chairs

Elastic backrest frame, height adjustable by 60 mm in six lockable positions, made of through-dyed, fiberglass-reinforced polyamide, covered with Fiberflex, optionally also with fabric (and extra padding).

All models optionally with soft padding (with extra cushion thickness). For models with management grade upholstery, the backrest frame also optionally comes with back cushioning with extra padding and the front of the backrest also with a concealed, cut foam fleece sewn into the cover and with side facings, optionally with a leather cover.

All models optionally with soft padding (with extra cut foam). Medium-high and high backrest, high backrest optionally with headrest (height 16 cm), either in the same material as the backrest cover, or covered in leather on the front. The backrest is replaceable.

Model 175/73 with soft padding, as well as color-contrasting double seams and contour-defining stitching.

Seat and backrest

Cantilever chair/four-leg visitor chair

Unitary shell-backrest component made of black or white through-dyed, fiberglass-reinforced polypropylene. Seat cushioning made of polyurethane one-piece molded foam, in models with management grade upholstery (models 176/71, 178/71) with additional padding and side facings. All models optionally with soft padding (with extra cut foam). In models 176/7, 178/7 seat cushioning covered in the same material as the backrest cover in Fiberflex or fabric, in models 176/71 and 178/71 with management grade upholstery optionally also covered in leather. The seat is replaceable.

The backrest frame is covered in Fiberflex, in models 176/7, 178/7 optionally with back covered in fabric (with additional padding).

In models with management grade upholstery optionally with backrest upholstery in fabric or leather, with additional padding, as well as on the front of backrest also with concealed, cut foam fleece sewn into the cover and side facings, backrest cover is replaceable.

Armrests

Task chairs

3D armrests made of fiberglass-reinforced, black or white through-dyed polyamide. Armrest pads made of black or gray, through-dyed polyurethane (TPU), optionally also made of black polyurethane foam and covered in leather if desired. Upholstered, leather-covered armrests (optional) in model 175/73 with color-contrasting stitching.

Through-dyed black or white polypropylene armrest covers. Height of armrests adjustable by 100 mm (eight lockable positions), depth by 40 mm, can be swiveled 30° inward and outward in each case.

Conference/visitor chairs

Fixed armrests made of fiberglass-reinforced, black, through-dyed polyamide. Armrest pads made of black, through-dyed polyurethane (TPU), optionally also made of polyurethane foam and covered in leather if desired. Armrest covers made of black, through-dyed polypropylene.

Cantilever chair/four-leg visitor chair

Black or gray through-dyed polypropylene armrest pads. In the case of non-stackable chairs, optionally with upholstered armrests, when covered in fabric with black leather 74/99, when covered in leather to match the color of the leather.



Standards

The ON task chairs and visitor/meeting chairs comply with the type A or B DIN EN 1335 office-chair, ANSI/BIFMA X5.1 and IGR standards. On request, NPR 1813 models are available.

The ON cantilever chairs and four-leg visitor chairs comply with the DIN EN 16139-L1 and ANSI/BIFMA X5 standards.



Accessories

Optionally for visitor chair model 176/7: Inline connector model 177 made of zinc-plated steel.

Optionally for cantilever chair, model 178/7, four-wheeled trolley, model 178 for 8 cantilever chairs. Optionally, the ON task, visitor and conference chairs (without headrest) can also be shipped with dismantled backrests in boxes.

All visitor and conference chairs have glides for soft flooring (e.g. carpets). On request, available with swivel-mounted column, not height adjustable, (at no additional charge).

Please note:

The prices for types with cushioning that includes fabrics and leather provided by the customer are given on request.

Four-leg chairs: to the DIN EN 16139-L1 office-chair standard, up to 5 chairs can be stacked vertically.

Cantilever chair: to the DIN EN 16139-L1 office-chair standard, up to 3 chairs can be stacked vertically.

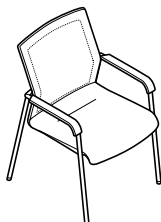
Stacking versions with coated frames can cause color to rub off, which is not covered by our guarantee. The same applies when inline connectors are used. We recommend chrome-plated versions for circumstances like these.





Standard height backrest

■ 90 ■ 64 ■ 64
 ■ 43



176/7

Seat and backrest shell in black or white, backrest covered with Fiberflex fabric, polypropylene armrests with seat cushioning, optionally with soft padding (please state in order), up to 5 stackable free-standing, Coated frame, color-matched with the shell Bright chrome-plated frame

Additional charge/reduced prices

Covered backrest (not in the case of artificial leather 58)
 Backrest with soft padding
 Upholstered, leather-covered armrests (not stackable)

	35	47	51 54 56 58	60 64 65 66 68	91 92
	SEK	SEK	SEK	SEK	SEK
	6275 7463	7175 8363	7388 8575	7588 8775	7900 9088
	1213	1288 1463	1588 1738	1788 1938	2100 2313
	2913	2913	2913	2913	2913

Standard height backrest

■ 92 ■ 61 ■ 60
 ■ 43



178/7

Seat and backrest shell in black or white, backrest covered with Fiberflex fabric, polypropylene armrests with seat cushioning, optionally with soft padding (please state in order), up to 5 stackable free-standing, Coated frame, color-matched with the shell Bright chrome-plated frame

Additional charge/reduced prices

Covered backrest (not in the case of artificial leather 58)
 Backrest with soft padding
 Upholstered, leather-covered armrests (not stackable)

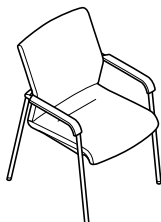
	35	47	51 54 56 58	60 64 65 66 68	91 92
	SEK	SEK	SEK	SEK	SEK
	6550 7738	7413 8600	7613 8800	7800 8988	8100 9288
	1213	1288 1463	1588 1738	1788 1938	2100 2313
	2913	2913	2913	2913	2913

All visitor and conference chairs have glides for soft flooring (e. g. carpets). Four-leg chair with casters for soft flooring (e. g. carpets). Please order with soft casters (at no extra charge) for hard flooring (e. g. stone, parquet)
 All cantilever chairs are fitted with anti-tilt stoppers as the standard design for soft flooring (e. g. carpets). For hard floorings (e. g. stone) please order with soft glides, for wooden floorings (e. g. parquet) please order with extra felt glides (at no extra charge in each case).



Standard height backrest

■ 90 ■ 64 ■ 64
 ■ 43



176/71

Seat and backrest shell in black or white, backrest covered with Fiberflex fabric, polypropylene armrests seat with management grade upholstery, optionally with soft padding (please state in order), Coated frame, color-matched with the shell Bright chrome-plated frame

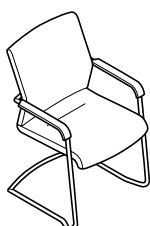
Additional charge/reduced prices

Backrest with management grade upholstery Upholstered, leather-covered armrests

	51 56	60 64 65 66 68	91 92	74	87
	SEK	SEK	SEK	SEK	SEK
	8738 9925	8963 10150	9513 10700	12963 14150	14038 15225
	3938 2913	4225 2913	4938 2913	5838 2913	7650 3313

Standard height backrest

■ 92 ■ 61 ■ 60
 ■ 43



178/71

Seat and backrest shell in black or white, backrest covered with Fiberflex fabric, polypropylene armrests seat with management grade upholstery, optionally with soft padding (please state in order), Coated frame, color-matched with the shell Bright chrome-plated frame

Additional charge/reduced prices

Backrest with management grade upholstery Upholstered, leather-covered armrests

	51 56	60 64 65 66 68	91 92	74	87
	SEK	SEK	SEK	SEK	SEK
	8763 9950	8975 10163	9500 10688	12788 13975	13813 15000
	3938 2913	4225 2913	4938 2913	5838 2913	7650 3313



Inline connector

177
(for model 176/7)

SEK

563

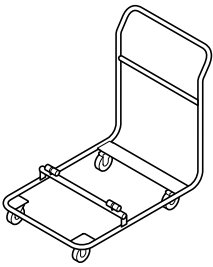


Four-wheeled trolley

178
for 8 cantilever chairs

SEK

10550



20 Range

Stitz 2

Design: ProduktEntwicklung Roericht



Technical details

Function



Stitz is a sitting-standing stool with precision-adjustable height via an encapsulated gas lift. Stitz is ideal for people weighing up to 120 kg.

Frame

Black elastomer base filled with quartz sand. Black polyamide base plate.

Seat

Black polyamide seat frame. Cork insert, either treated with hard wax, covered with fabric or embossed leather. Underneath the seat, black polyamide grip to engage the gas lift.

Stitz
 63/88  31

201/1
 Cork seat
 black frame



SEK

6550



Upholstery material

Upholstery material	SEK	SEK	SEK	SEK
51	60	64	91	74
56	65	66	92	
SEK	SEK	SEK	SEK	
7163	7300	7575	7613	

Stitz
 63/88  31

201/2
 Black frame



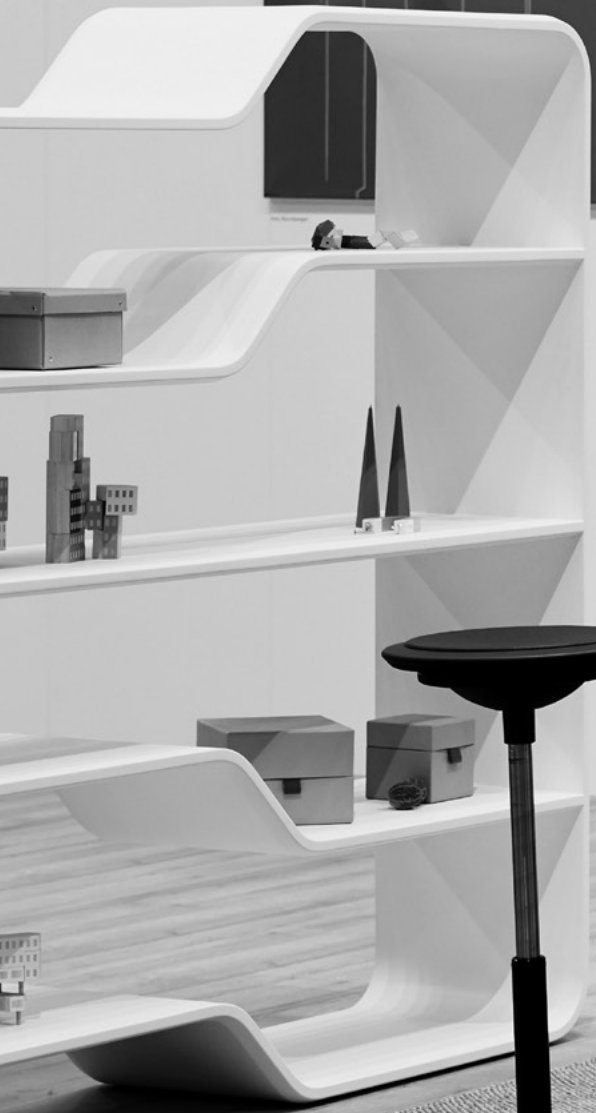
Awards

Design Preis Schweiz
 Prix Design Suisse
 Design Prize Switzerland



reddot award
 winner





202 Range Stand-up

Design: Thorsten Franck



Further
information

Technical details

Function

An object in motion, when sat on it's turned from a one-legged to stable three-legged piece of furniture.

Body

Tapered hollow body made of EPP (expanded polypropylene) with a lid upholstered with cut foam that serves as the seat. Body and seat fully covered with three-dimensional fabric. Tapered base made of black, non-slip plastic with integrated steel weights and damping cylinder. Carry-strap made of 100% polypropylene in black.

Weight

Just 4.5 kg

Information

In wet or dirty conditions, the base's grip can vary. It can cause scuff marks on light-colored flooring.

Awards




Stand-up
 E67 H32


202/0101 covered in Fiberflex fabric 35/99: black incl. carry-strap black base	4375
202/0102 covered in Fiberflex fabric 35/89: red incl. carry-strap black base	4375
202/0103 covered in Fiberflex fabric 35/63: light blue incl. carry-strap black base	4375
202/0104 covered in Fiberflex fabric 35/56: green incl. carry-strap black base	4375
202/0105 covered in Fiberflex fabric 35/34: orange incl. carry-strap black base	4375
202/0107 covered in Fiberflex fabric 35/25: anthracite incl. carry-strap black base	4375
202/0108 covered in Fiberflex fabric 35/11: gray incl. carry-strap black base	4375
202/0110 covered in Fiberflex fabric 35/1130: bronze incl. carry-strap black base	4375
202/0111 covered in Fiberflex fabric 35/1110: beige including carry-strap black base	4375
202/0112 covered in Fiberflex fabric 35/8110: sage including carry-strap black base	4375
202/0113 covered in Fiberflex fabric 35/6123: cobalt blue including carry-strap black base	4375

222 Range Occo

Design: jehs+laub



Technical details

Function

Occo offers superior comfort, enormous versatility and a vast range of design options in a distinctive design language. It's ideal for conference rooms, open-plan meeting areas, cafés, co-working spaces or in homes.

Frame

Four-leg frame models 221/10, 221/11, 221/12, 222/10, 222/11, 222/12

Tubular steel frame, stackable (except for model 222/12), with a textured matte finish coated white, black, gray, gray-beige, emerald green, sienna red or bright chrome-plated. Up to 10 versions without upholstery can be stacked, and 8 with padding on the seat and on the inside.

Please note: The leather-cover version is not stackable. Stacking versions with coated frames can cause color to rub off, which is not covered by our guarantee. We recommend chrome-plated frames for this purpose.

Models 221/10 and 222/10 (shell without upholstery) with four separators made of PUR and frame cover made of plastic (PP), each in dark gray. Remove the optional felt pad before stacking because permanent pressure marks can otherwise occur.

Models 221/11, 221/12, 222/11 and 222/12 with stacking guard made of plastic (PP) in dark gray. Tubular steel frame, stackable (except for model 222/12), with a textured matte finish coated white, black, gray, gray-beige, emerald green, sienna red or bright chrome-plated. Up to 10 versions without upholstery can be stacked, and 8 with padding on the seat and on the inside. Please note: The leather-cover version is not stackable. Stacking versions with coated frames can cause color to rub off, which is not covered by our guarantee. We recommend chrome-plated frames for this purpose.

Solid wood four-leg frame models 221/20, 221/21, 221/22, 222/20, 222/21, 222/22

Seat bearer made of tubular steel in dark gray with a textured matte finish to fit onto the seat shell and to attach the four legs made of solid oak with a natural oiled finish.

Sled (skid) base, models 221/100, 221/101, 221/102 und 222/100, 222/101, 222/102

Sled (skid) base made of steel rod, 12 mm in diameter, coated with a textured matte finish in white, black, gray, gray-beige, emerald green or sienna red or bright chrome plated. Coated frames as a standard and, if required bright chrome-plated frames optionally come with multipurpose glides made of black polyamide. Models 221/100, 221/101 and 221/102 optionally with inline connectors made of black through-dyed polyamide including multipurpose glides, optionally with extra felt inserts for flooring that easily scratches (e.g. stone, parquet).

Four-star base models 221/30, 221/31, 221/32, 222/30, 222/31, 222/32, five-star base models 221/40, 221/41, 221/42, 222/40, 222/41, 222/42

Butted tubular steel frame with a textured matte finish coated in white, black, gray, gray-beige, emerald green, sienna red or bright chrome-plated with seat bearer made of die-cast aluminum in dark gray with a textured matte finish to attach to the shell. In the case of four-star base frames, the steel glides are in dark gray with a textured matte finish. Four-leg and four-star base models are fitted with multipurpose glides for soft and hard floorings. For sensitive flooring, please order with extra felt glides (at no additional charge).

Five-star base models 221/40, 221/41, 221/42, 222/40, 222/41, 222/42 with twin-wheel swivel casters, load-dependent braking, made of black polypropylene compliant with DIN EN 12529 as the standard version for carpets, optionally with gray tire made of polyurethane for hard flooring.

Four-leg chair and star base

Base frames

- 51 Bright chrome-plated
- 85 Coated gray with a textured matte finish (Pantone Cool Gray 10 C)
- 86 Coated gray-beige with a textured matte finish (Pantone 7530 C)
- 90 Coated with a black textured matte finish (RAL9011)
- 91 Coated white with a textured matte finish (RAL9016)
- 94 Coated emerald green with a textured matte finish (Pantone 5477 C)
- 95 Coated sienna red with a textured matte finish (Pantone 3523 C)

Five-star base

Star base

- 51 Bright chrome-plated
- 79 Matte-polished aluminum
- 90 Coated with a black textured matte finish (RAL9011)
- 91 Coated white with a textured matte finish (RAL9016)

Gas lift

- Bright chrome-plated or coated black
- Bright chrome-plated or coated black
- Coated black
- Bright chrome-plated or coated black

Casters

- Black
- Black
- Black
- Black

Mechanism

- High-luster polished aluminum
- Matte-polished aluminum
- High-luster polished aluminum
- High-luster polished aluminum

Counter

Star base

- 50 Plastic
- 52 Polished aluminum
- 72 High-luster polished aluminum
- 90 Coated with a black textured matte finish (RAL9011)
- 91 Coated white with a textured matte finish (RAL9016)

Gas lift

- Black
- Black
- Black
- Black

Casters

- Black
- Black
- Black
- Black

Awards



reddot award
winner



Five-star base models 221/00, 221/01, 221/02, 222/00, 222/01, 222/02

Five-star base made of die-cast aluminum with a textured matte finish, coated in white or black, matte polished or with bright chrome plating, with swivel-mounted gas lift column and a lever allows the height to be precision adjusted, seat bearer made of die-cast aluminum in dark gray, optionally with active rocking technology, can be locked in a horizontal neutral 0 position, with a die-cast aluminum housing, matte polished or high-luster polished. Compliant with DIN EN 1335 and ANSI/BIFMA X 5.1 with twin-wheel swivel casters with load-dependent braking made of black polyamide compliant with DIN EN 12529, as the standard version for carpets; with gray polyurethane tyre for hard flooring.

Counter stool base frame models 221/50, 221/51, 221/52, 222/50, 222/51, 222/52

Five-star base made of black through-dyed, fiberglass-reinforced polyamide, optionally of die-cast aluminum, coated, polished or high-luster polished, with multipurpose twin-wheel swivel casters with load-dependent braking. Swivel-mounted, black gas lift, precision-adjustable with a black lever, with a height-adjustable, bright chrome-plated foot ring and lock screw to keep it in place. Seat bearer made of die-cast aluminum in dark gray.

Sled (skid) base bar stools, models 223/10, 223/11

Sled (skid) base, stackable when not upholstered, with steel rod footrest, 12 mm diameter, with a textured matte finish coated in white, black, gray, gray-beige, emerald green, sienna red or bright chrome-plated. Please note: Stacking versions with coated frames can cause color to rub off, which is not covered by our guarantee. We recommend chrome-plated frames for this purpose.

Height-adjustable bar stools with a column foot, models 223/90, 223/91

Brushed, stainless steel disc base, swivel-mounted column with encapsulated gas lift and precision-adjustable height, brushed stainless steel footrest and lever. Seat bearer made of molded flat steel in dark gray.

Solid wood four-leg frame bar stools, models 223/20, 223/21

Seat bearer made of tubular steel in dark gray with a textured matte finish to fit onto the seat shell and to attach the four legs made of solid oak with a natural oiled finish. With steel rod footrest, bright chrome-plated

Seat and backrest

Unitary, ergonomically molded seat shell with cut-out section, made of reinforced through-dyed polypropylene optionally in white, black, gray, gray-beige, emerald green or sienna red. Models without upholstery optionally with a felt seat cushion with non-slip coating. In a light mottled hue, anthracite, graphite, mango, verde, deep water. All upholstery in models with seat upholstery or padding on the inside is made of cut foam.

Standards

The Occo multipurpose chairs with four-leg frames comply with the DIN EN 16139-L1 office-chair standard.

Meets the DIN EN 16139 office-chair standard, can be stacked:
222/10 four-leg frame, without upholstery up to 10 stackable,
222/11 four-leg frame, with seat cushioning, up to 6 stackable,
222/12 four-leg frame, with padding on the inside, up to 4 stackable.



Please note

To ensure quality is maintained, we don't offer white leather (74/72). All other standard leather colors are possible.

When exposed to ultra violet rays for long periods of time, the colors of plastics can change slightly. Due to the nature of the material, there are slight differences in the color between white table tops with bonded surfaces and HPL table tops and the white Occo plastic chairs.

Felt is a natural product. Therefore, there can be differences in the color. These differences are not a justified reason for complaint but underscore the material's uniqueness.

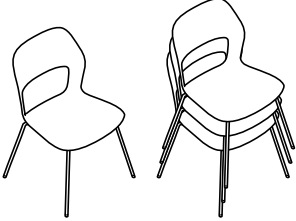
All chairs are fitted with multipurpose glides for soft and hard floorings, in the case of sensitive floorings please order with extra felt glides (at no additional charge).

Five-star base frames are fitted with casters for soft floorings. Please order with soft casters (at no additional charge) for hard flooring (e.g. stone, parquet)



Multipurpose chair

■83 ■55 ■53
■44



221/10

Four-leg frame, without upholstery, up to 10 stackable free-standing
Coated frame, color-matched with the shell
Bright chrome-plated frame

SEK

3263
3263

Accessories

186 Four-wheeled trolley
for 6 multipurpose chairs

5013

222 Felt cushion
with non-slip coating, available in 6 colors

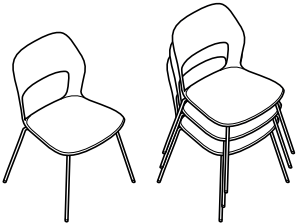
675

Upholstery material

		51	60		
		54	64		
		58	66	91	
37		56	68	92	74
38					87

Multipurpose chair

■83 ■55 ■53
■44



221/11

Four-leg frame with seat cushioning, up to
8 stackable free-standing (except with leather
cover)
Coated frame, color-matched with the shell
Bright chrome-plated frame

SEK

4475
4475

SEK

5088
5088

SEK

5325
5325

SEK

5700
5700

SEK

6150
6150

SEK

7063
7063

Accessories

186 Four-wheeled trolley
for 6 multipurpose chairs

5013

5013

5013

5013

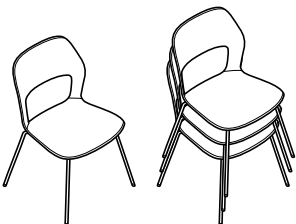
5013

5013

		51	60		
		54	64		
		56	66	91	
37		58	68	92	74
38					87

Multipurpose chair

■83 ■55 ■53
■44



221/12

Four-leg frame with padding on the inside, up to
8 stackable free-standing (except with leather
cover)
Coated frame, color-matched with the shell
Bright chrome-plated frame

SEK

6888
6888

SEK

7950
7950

SEK

8288
8288

SEK

8875
8875

SEK

10863
10863

SEK

13613
13613

Accessories

186 Four-wheeled trolley
for 6 multipurpose chairs

5013

5013

5013

5013

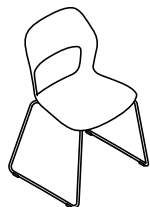
5013

5013



Multipurpose chair

83 55 53
44



221/100

Sled base, not upholstered, up to 6 stackable free-standing
Coated base frame, color-matched with the shell, with multipurpose glides (optionally with felt insert)
Bright chrome-plated frame

Additional charge/reduced prices

Multipurpose glides for bright chrome-plated frame (optionally with felt insert)

Accessories

188 Four-wheeled trolley for 10 sled-base chairs

222 Felt cushion with non-slip coating, available in 6 colors

238 Inline connector

SEK

3263

3263

188

6913

675

563

Upholstery material

		51	60			
		54	64			
37		56	65	91		
38		58	66	92	74	87
			68			

Multipurpose chair

83 55 53
44



221/101

Sled base with seat cushioning, up to 6 stackable free-standing (except with leather cover)
Coated base frame, color-matched with the shell, with multipurpose glides (optionally with felt insert)
Bright chrome-plated frame

Additional charge/reduced prices

Multipurpose glides for bright chrome-plated frame (optionally with felt insert)

Accessories

188 Four-wheeled trolley for 10 sled-base chairs

238 Inline connector

SEK

SEK

SEK

SEK

SEK

SEK

4475

4475

5088

5088

5325

5325

5700

5700

6150

6150

7063

7063

188

188

188

188

188

188

6913

563

6913

563

6913

563

6913

563

6913

563

37

38

51

54

56

58

64

65

66

68

91

92

74

87

Multipurpose chair

83 55
44



221/102

Sled base with padding on the inside, up to 6 stackable free-standing (except with leather cover)
Coated base frame, color-matched with the shell, with multipurpose glides (optionally with felt insert)
Bright chrome-plated frame

Additional charge/reduced prices

Multipurpose glides for bright chrome-plated frame (optionally with felt insert)

Accessories

188 Four-wheeled trolley for 10 sled-base chairs

238 Inline connector

SEK

SEK

SEK

SEK

SEK

SEK

6888

6888

7950

7950

8288

8288

8875

8875

10863

10863

13613

13613

188

188

188

188

188

188

6913

563

6913

563

6913

563

6913

563

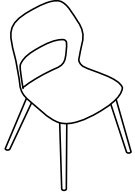
6913

563



Multipurpose chair

83 54 56
44



221/20

Solid oak four-leg frame with a natural oiled finish
not upholstered
not stackable

SEK

5675

Accessories

222 Felt cushion
with non-slip coating, available in 6 colors

675

Upholstery material

	37	51	60	91	74	87
	38	54	64	92		
		56	65			
		58	66			
			68			
SEK	SEK	SEK	SEK	SEK	SEK	SEK
6888	7500	7738	8113	8563	9475	

Multipurpose chair

83 54 56
44



221/21

Solid oak four-leg frame with a natural oiled finish
with seat cushioning
not stackable

SEK

SEK

SEK

SEK

SEK

SEK

6888

7500

7738

8113

8563

9475

	37	51	60	91	74	87
	38	54	64	92		
		56	65			
		58	66			
			68			
SEK	SEK	SEK	SEK	SEK	SEK	SEK
9300	10363	10700	11288	13275	16025	

Multipurpose chair

83 54 56
44



221/22

Solid oak four-leg frame with a natural oiled finish
with padding on the inside
not stackable

SEK

SEK

SEK

SEK

SEK

SEK

9300

10363

10700

11288

13275

16025



Visitor chair

H83 H51 H53
H44



221/30

Four-star base frame on glides, swivel-mounted
Coated frame, color-matched with the shell
Bright chrome-plated frame

SEK

6700
6700

Accessories

222 Felt cushion
with non-slip coating, available in 6 colors

675

Upholstery material

		51	60		
		54	64		
		56	65		
		58	66	91	
			68	92	74
	37				87
	38				

Visitor chair

H83 H51 H53
H44



221/31

Four-star base frame on glides, with seat
cushioning, swivel-mounted
Coated frame, color-matched with the shell
Bright chrome-plated frame

SEK	SEK	SEK	SEK	SEK	SEK
7913	8525	8763	9138	9588	10500
7913	8525	8763	9138	9588	10500

		51	60		
		54	64		
		56	65		
		58	66	91	
			68	92	74
	37				87
	38				

Visitor chair

H83 H51 H53
H44



221/32

Four-star base frame on glides, with padding on
the inside, swivel-mounted
Coated frame, color-matched with the shell
Bright chrome-plated frame

SEK	SEK	SEK	SEK	SEK	SEK
10325	11388	11725	12313	14300	17050
10325	11388	11725	12313	14300	17050



Height-adjustable task chair

☐ 80/91 ☐ H 65 ☐ H 62

☐ 39/51



221/00

Five-star base, not upholstered
on casters, precision-adjustable height
Aluminum coated frame
Matte-polished aluminum frame
Bright chrome-plated aluminum frame

Accessories

222 Felt cushion
with non-slip coating, available in 6 colors

SEK

5288

5775

7088

675

Upholstery material

		51	60			
		54	64			
		56	65			
		58	66			
37				91		
38				92	74	87

Height-adjustable task chair

☐ 80/91 ☐ H 65 ☐ H 62

☐ 39/51



221/01

Five-star base, with seat cushioning
on casters, precision-adjustable height
Aluminum coated frame
Matte-polished aluminum frame
Bright chrome-plated aluminum frame

Additional charge/reduced prices

Active rocking mechanism

SEK	SEK	SEK	SEK	SEK	SEK
6500	7113	7350	7725	8175	9088
6988	7600	7838	8213	8663	9575
8300	8913	9150	9525	9975	10888
613	613	613	613	613	613

		51	60			
		54	64			
		56	65			
		58	66			
37				91		
38				92	74	87

Height-adjustable task chair

☐ 80/91 ☐ H 65 ☐ H 62

☐ 39/51



221/02

Five-star base, with padding on the inside
on casters, precision-adjustable height
Aluminum coated frame
Matte-polished aluminum frame
Bright chrome-plated aluminum frame

Additional charge/reduced prices

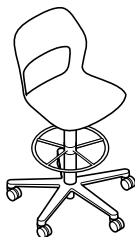
Active rocking mechanism

SEK	SEK	SEK	SEK	SEK	SEK
8913	9975	10313	10900	12888	15638
9400	10463	10800	11388	13375	16125
10713	11775	12113	12700	14688	17438
613	613	613	613	613	613



Counter stool

▣ 96/121 ▣ 67 ▣ 64
▣ 55/80



221/50

Five-star base, not upholstered on casters, precision adjustable height, with foot ring, bright chrome-plated (precision-adjustable height)
Plastic star base
Coated aluminum star base
Polished aluminum star base
High-luster polished aluminum frame

SEK

7725
8538
9013
9188

Accessories

222 Felt cushion with non-slip coating, available in 6 colors

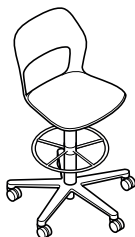
675

Upholstery material

	37	51	60	91		
	38	54	64	92	74	87
		56	65			
		58	66			
			68			

Counter stool

▣ 96/121 ▣ 67 ▣ 64
▣ 55/80



221/51

Five-star base, with seat cushioning, on casters, precision adjustable height, with foot ring, bright chrome-plated (precision-adjustable height)
Plastic star base
Coated aluminum star base
Polished aluminum star base
High-luster polished aluminum frame

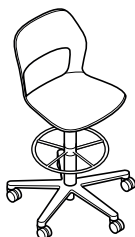
SEK

SEK	SEK	SEK	SEK	SEK	SEK
8938	9550	9788	10163	10613	11525
9750	10363	10600	10975	11425	12338
10225	10838	11075	11450	11900	12813
10400	11013	11250	11625	12075	12988

	37	51	60	91		
	38	54	64	92	74	87
		56	65			
		58	66			
			68			

Counter stool

▣ 96/121 ▣ 67 ▣ 64
▣ 55/80



221/52

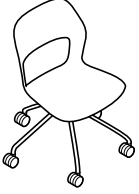
Five-star base, with padding on the inside, on casters, precision adjustable height, with foot ring, bright chrome-plated (precision-adjustable height)
Plastic star base
Coated aluminum star base
Polished aluminum star base
High-luster polished aluminum frame

SEK

SEK	SEK	SEK	SEK	SEK	SEK
11350	12413	12750	13338	15325	18075
12163	13225	13563	14150	16138	18888
12638	13700	14038	14625	16613	19363
12813	13875	14213	14800	16788	19538



Task chair



221/40 **SEK**
 Five-star base frame, not upholstered
 on casters, swivel-mounted
 Coated frame, color-matched with the shell
 Bright chrome-plated frame 6875
6875

Accessories
222 Felt cushion
 with non-slip coating, available in 6 colors 675

Upholstery material

	37		51		60	
	38	58	54	64	91	74
	38	58	65	68	92	87
SEK	SEK	SEK	SEK	SEK	SEK	SEK
8088	8700	8938	9313	9763	10675	10675
8088	8700	8938	9313	9763	10675	10675

Task chair



221/41
 Five-star base frame
 on casters, with seat cushioning, swivel-mounted
 Coated frame, color-matched with the shell
 Bright chrome-plated frame

	37		51		60	
	38	58	54	64	91	74
	38	58	65	68	92	87
SEK	SEK	SEK	SEK	SEK	SEK	SEK
10500	11563	11900	12488	14475	17225	17225
10500	11563	11900	12488	14475	17225	17225

Task chair

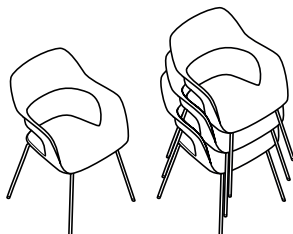


221/42
 Five-star base frame
 on casters, with padding on the inside,
 swivel-mounted
 Coated frame, color-matched with the shell
 Bright chrome-plated frame



Multipurpose chair

83 57 58
44



222/10

Four-leg frame, not upholstered, up to 10 stackable free-standing
Coated frame, color-matched with the shell
Bright chrome-plated frame

SEK

3263
3263

Accessories

186 Four-wheeled trolley
for 6 multipurpose chairs

5013

222 Felt cushion
with non-slip coating, available in 6 colors

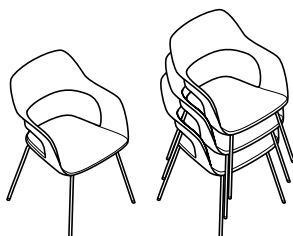
675

Upholstery material

		51	60		
		54	64		
		56	65		
		58	66	91	
			68	92	74
	37				
	38				87

Multipurpose chair

83 57 58
44



222/11

Four-leg frame with seat cushioning, up to
6 stackable free-standing (except with leather
cover)

Coated frame, color-matched with the shell
Bright chrome-plated frame

SEK

4475
4475

SEK

5088
5088

SEK

5325
5325

SEK

5700
5700

SEK

6150
6150

SEK

7063
7063

Accessories

186 Four-wheeled trolley
for 6 multipurpose chairs

5013

5013

5013

5013

5013

5013

		51	60		
		54	64		
		56	65		
		58	66	91	
			68	92	74
	37				
	38				87

Multipurpose chair

83 57 58
44



222/12

Four-leg frame with padding on the inside
Coated frame, color-matched with the shell, not
stackable

Bright chrome-plated frame, not stackable

SEK

6888
6888

SEK

7950
7950

SEK

8288
8288

SEK

8875
8875

SEK

10863
10863

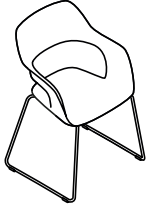
SEK

13613
13613



Multipurpose chair

83 57 54
44



222/100

Sled (skid) base, without upholstery
Coated base frame, color-matched with the shell, with multipurpose glides (optionally with felt insert)
Bright chrome-plated frame

SEK

3263

3263

Additional charge/reduced prices

Multipurpose glides for bright chrome-plated frame (optionally with felt insert)

188

Accessories

188 Four-wheeled trolley for 10 sled-base chairs

6913

222 Felt cushion

with non-slip coating, available in 6 colors

675

Upholstery material

Multipurpose chair

83 57 54
44



222/101

Sled (skid) base, with seat cushioning
Coated base frame, color-matched with the shell, with multipurpose glides (optionally with felt insert)
Bright chrome-plated frame

SEK

SEK

SEK

SEK

SEK

SEK

4475

4475

5088

5088

5325

5325

5700

5700

6150

6150

7063

7063

Additional charge/reduced prices

Multipurpose glides for bright chrome-plated frame (optionally with felt insert)

188

188

188

188

188

188

Accessories

188 Four-wheeled trolley for 10 sled-base chairs

6913

6913

6913

6913

6913

6913

37

38

51

54

56

58

60

64

65

66

68

91

92

74

87

Multipurpose chair

83 57 54
44



222/102

Sled (skid) base, with padding on the inside
Coated base frame, color-matched with the shell, with multipurpose glides (optionally with felt insert)
Bright chrome-plated frame

SEK

SEK

SEK

SEK

SEK

SEK

6888

6888

7950

7950

8288

8288

8875

8875

10863

10863

13613

13613

Additional charge/reduced prices

Multipurpose glides for bright chrome-plated frame (optionally with felt insert)

188

188

188

188

188

188

Accessories

188 Four-wheeled trolley for 10 sled-base chairs

6913

6913

6913

6913

6913

6913



Multipurpose chair

83 57 55
44



222/20

Solid oak four-leg frame with a natural oiled finish
not upholstered
not stackable

SEK

5675

Accessories

222 Felt cushion
with non-slip coating, available in 6 colors

675

Upholstery material

	37	51	60	91		
	38	54	64	92	74	87
		56	65			
		58	66			
			68			
SEK	SEK	SEK	SEK	SEK	SEK	SEK
6888	7500	7738	8113	8563	9475	

Multipurpose chair

83 57 55
44



222/21

Solid oak four-leg frame with a natural oiled finish
with seat cushioning
not stackable

	37	51	60	91		
	38	54	64	92	74	87
		56	65			
		58	66			
			68			
SEK	SEK	SEK	SEK	SEK	SEK	SEK
9300	10363	10700	11288	13275	16025	

Multipurpose chair

83 57 55
44



222/22

Solid oak four-leg frame with a natural oiled finish
with padding on the inside
not stackable



Visitor chair

83 57 56
44



222/30

Four-star base frame, not upholstered,
swivel-mounted
Coated frame, color-matched with the shell
Bright chrome-plated frame

Accessories

222 Felt cushion
with non-slip coating, available in 6 colors

SEK

6700
6700

Upholstery material

		51	60		
		54	64		
		56	65	91	
		58	66	92	74
	37				
	38				87

Visitor chair

83 57 56
44



222/31

Four-star base frame
with seat cushioning, swivel-mounted
Coated frame, color-matched with the shell
Bright chrome-plated frame

SEK

7913
7913

SEK

8525
8525

SEK

8763
8763

SEK

9138
9138

SEK

9588
9588

SEK

10500
10500

		51	60		
		54	64		
		56	65	91	
		58	66	92	74
	37				
	38				87

Visitor chair

83 57 56
44



222/32

Four-star base frame
with padding on the inside, swivel-mounted
Coated frame, color-matched with the shell
Bright chrome-plated frame

SEK

10325
10325

SEK

11388
11388

SEK

11725
11725

SEK

12313
12313

SEK

14300
14300

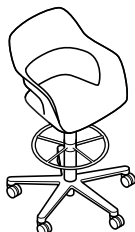
SEK

17050
17050



Counter stool

▣96/121 ▣H67 ▣64
▣55/80



222/50

Five-star base, not upholstered on casters, precision adjustable height, with foot ring, bright chrome-plated (precision-adjustable height)
Plastic star base
Coated aluminum star base
Polished aluminum star base
High-luster polished aluminum frame

SEK

7725
8538
9013
9188

Accessories

222 Felt cushion with non-slip coating, available in 6 colors

675

Upholstery material

Counter stool

▣96/121 ▣H67 ▣64
▣55/80



222/51

Five-star base, with seat cushioning, on casters, precision adjustable height, with foot ring, bright chrome-plated (precision-adjustable height)
Plastic star base
Coated aluminum star base
Polished aluminum star base
High-luster polished aluminum frame

SEK

8938
9750
10225
10400

SEK

9550
10363
10838
11013

SEK

9788
10600
11075
11250

SEK

10163
10975
11450
11625

SEK

10613
11425
11900
12075

SEK

11525
12338
12813
12988

37
38

54
56
58
51

60
66
68
64
65

91
92

74

87

Counter stool

▣96/121 ▣H67 ▣64
▣55/80



222/52

Five-star base, with padding on the inside, on casters, precision adjustable height, with foot ring, bright chrome-plated (precision-adjustable height)
Plastic star base
Coated aluminum star base
Polished aluminum star base
High-luster polished aluminum frame

SEK

11350
12163
12638
12813

SEK

12413
13225
13700
13875

SEK

12750
13563
14038
14213

SEK

13338
14150
14625
14800

SEK

15325
16138
16613
16788

SEK

18075
18888
19363
19538

37
38

51
54
56
58

60
64
65
66
68

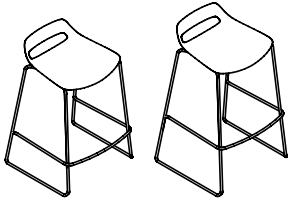
91
92

74

87



Bar stool
H 77/87 H 53/54 H 51/52



223/10

Skid (sled) base, without upholstery, up to 10 stackable free-standing, seating height 65 cm
Coated frame, color-matched with the shell
Bright chrome-plated frame
Skid (sled) base, without upholstery, up to 10 stackable free-standing, seating height 75 cm
Coated frame, color-matched with the shell
Bright chrome-plated frame

SEK

3863
3863
3863
3863

Accessories

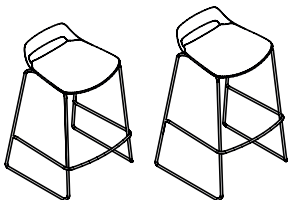
223 Bar stool felt cushion
with non-slip coating, available in 6 colors

675

Upholstery material

			60		
			64		
			65		
			66	91	
			68	92	74
	37	51			
	38	54			
		56			
					87
	SEK	SEK	SEK	SEK	SEK
	5075	5688	5925	6300	6750
	5075	5688	5925	6300	6750
	5075	5688	5925	6300	6750
	5075	5688	5925	6300	6750

Bar stool
H 77/87 H 53/54 H 51/52



223/11

Skid (sled) base with seat cushioning, not stackable, seating height 65 cm
Coated frame, color-matched with the shell
Bright chrome-plated frame
Skid (sled) base with seat cushioning, not stackable, seating height 75 cm
Coated frame, color-matched with the shell
Bright chrome-plated frame



Bar stool

77/87 49/52 47/49



223/20

Solid oak four-leg frame with a natural oiled finish, not upholstered, **65 cm seating height** not stackable
Solid oak four-leg frame with a natural oiled finish, not upholstered, 75 cm seating height not stackable

SEK

6588

6588

Accessories

223 Bar stool felt cushion with non-slip coating, available in 6 colors

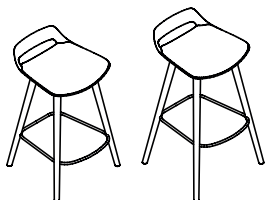
675

Upholstery material

	37	51	60	64	65	66	68	91	92	74	87
	38	54	65	66	66	66	68	92	92	74	87
SEK	SEK	SEK	SEK	SEK	SEK	SEK	SEK	SEK	SEK	SEK	SEK
	7800	8413	8650	9025	9475	10388					
	7800	8413	8650	9025	9475	10388					

Bar stool

77/87 49/52 47/49



223/21

Solid oak four-leg frame with a natural oiled finish, with seat cushioning, seating height 65 cm not stackable
Solid oak four-leg frame with a natural oiled finish, with seat cushioning, seating height 75 cm not stackable

Programm 222

Occo

Design: jehs+laub



Technical details

Tables

Frame

Models 222/61, 222/71, 222/81, 222/91

With a four-leg frame, solid oak, with a natural oiled finish.

Models 222/61 and 222/71

In standing height with a horizontal stretcher made of bright chrome-plated round steel. With multipurpose glides for soft and hard floorings. In the case of wooden floorings (e.g. parquet) please order with extra felt glides (at no additional charge).

Models 222/62 and 222/72

Side-table height with a four-star base made of die-cast aluminum with a textured matte finish, coated in white or black, matte-polished or with bright chrome plating, with a table column complete with textured matte finish in black or coated white when the star base is white. Black, multipurpose glides made of plastic for all types of flooring.

Model 222/73

In side-table height with a three-star base made of flat steel and table column made of tubular steel, coated white or black with a textured matte finish, with round steel flange, coated black. Multipurpose glides made of black polypropylene

Models 222/81 and 222/91

In standing height with a center underframe and diagonal stretcher made of bright chrome-plated round steel.

Core panels on table top, table top group 2 – veneer variant 1 and 2

MDF (medium density fiberboard), table top thickness 26 mm

Variant 1:

Beech or oak veneer from the Wilkhahn woodstain color samples with chamfered wood edging, color-matched as far as possible with the veneer. Models 222/61, 222/71, 222/81 and 222/91 only available with oak veneer.

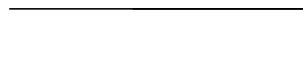


E2 – 5 chamfered wood lipping, 12 mm

Table top group 5 – with bonded surface

Table top thickness 25 mm thick, with a bonded melamine resin surface in white or black with straight plastic edging, color matched with the surface.

Heights that can be ordered: 46 cm and 51 cm, table height 74 cm, standing height 106 cm

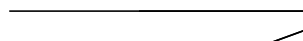


E2 – 3 straight plastic lipping

Table top group 7 - black/white through-dyed

Table top thickness 12 mm, made of through-dyed HPL (High Pressure Laminate) in black or white, with chamfered edging.

Side-table heights that can be ordered: 45 cm and 50 cm, table height 73 cm, standing height 105 cm



E5 – 1 HPL-solid-core, chamfered lipping, 4 mm radius

Table top group 10 – solid wood

Table top thickness 25 mm, solid oak from the Wilkhahn woodstain color samples, natural oiled finish, edging, rounded on the bottom.

Heights that can be ordered: 46 cm and 51 cm, table height 74 cm, standing height 106 cm



E4 – 1 solid wood, rounded on the bottom

Information

Due to the nature of the material, there are slight differences in the color between white table tops with bonded surfaces and HPL table tops and the white Occo plastic chairs.

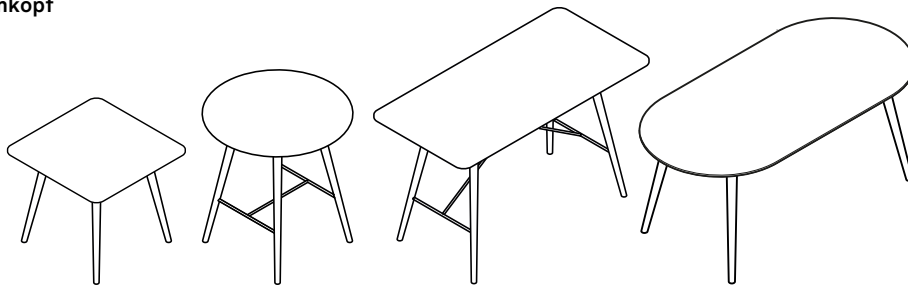
Lounge tables (except model 222/73)

Base frame

51	Bright chrome-plated
79	Matte-polished aluminum
90	Coated with a black textured matte finish (RAL 9011)
91	Coated white with a textured matte finish (RAL 9016)

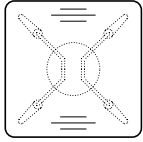
Column

Coated with a black textured matte finish (RAL 9011)
Coated with a black textured matte finish (RAL 9011)
Coated with a black textured matte finish (RAL 9011)
Coated white with a textured matte finish (RAL 9016)



5	7	7	2	10
Direct coating	Black through-dyed	White through-dyed	Veneer variant 1	Solid wood
SEK	SEK	SEK	SEK	SEK

Square



222/61

90 x 90

For 4 people

Solid oak four-leg frame with a natural oiled finish

15575

18000

19313

23038

30200

Additional charge/reduced prices

High table height

5888

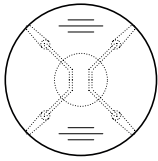
5888

5888

5888

5888

Round



222/71

Ø 100

For 4 people

Solid oak four-leg frame with a natural oiled finish

15663

18088

19588

23225

30275

Additional charge/reduced prices

High table height

5888

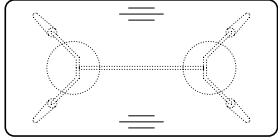
5888

5888

5888

5888

Rectangular



222/81

80 x 160

For 4-6 people

Solid oak four-leg frame with a natural oiled finish

19825

22650

24513

29238

41775

90 x 180

For 6 people

Solid oak four-leg frame with a natural oiled finish

20975

24100

26438

31850

43875

90 x 190

For 6 people

Solid oak four-leg frame with a natural oiled finish

21325

24738

27238

33025

52300

Additional charge/reduced prices

High table height

5888

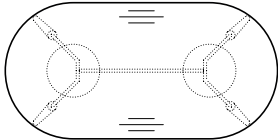
5888

5888

5888

5888

Oval



222/91

90 x 180

For 6 people

Solid oak four-leg frame with a natural oiled finish

20975

24100

26438

31850

50150

90 x 200

For 6 people

Solid oak four-leg frame with a natural oiled finish

21663

25325

28000

34300

54475

Additional charge/reduced prices

High table height

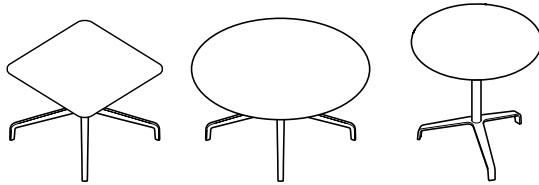
5888

5888

5888

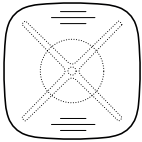
5888

5888



5	7	7	2	2	10
Direct coating	Black through-dyed	White through-dyed	Veneer variant 1	Veneer variant 2	Solid wood
SEK	SEK	SEK	SEK	SEK	SEK

Square

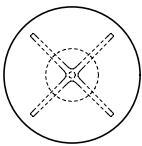


222/62

75 x 75, H 45
Four star base made of die-cast aluminum
Aluminum coated frame
Matte-polished aluminum frame
Bright chrome-plated aluminum frame

8863	10788	12000	15763	17613	21225
9350	11275	12488	16250	18100	21713
10663	12588	13800	17563	19413	23025

Round



222/72

Ø 90, H 45
Four star base made of die-cast aluminum
Aluminum coated frame
Matte-polished aluminum frame
Bright chrome-plated aluminum frame

12313	14138	15600	19350	21238	24813
12800	14625	16088	19838	21725	25300
14113	15938	17400	21150	23038	26613

Round



222/73

Ø 50, H 50
Three-star base made of steel
Coated frame

7563	8663	9250	12300	13575	16213
------	------	------	-------	-------	-------

290 Range Sola

Design: Justus Kolberg; licensor for products and sales: Davis Furniture, NC, US



Technical details

Function

The conference chair fuses innovative comfort with crisp design and a top quality appeal. The chair's aesthetic is defined by the linear shape of the seat shell and the distinctive lines of the aluminum frame. The frame branches out from the center column into a V-shaped support that culminates in the armrests.

The slender seat shell is swivel-mounted at the front and connected with a V-shaped support by two pressure springs at the back. As a result, the chair rocks back and forward comfortably without any extra mechanical parts required. The sprung pressure can easily be adjusted to suit personal levels of comfort and body weight. DIN 1335-1 compliant gas lift for precision-adjustable seating height.

Can be used in traditional conference and meeting rooms, executive offices and boardrooms, high-quality restaurants or prestigious dining areas.

Frame

Die-cast aluminum five-star base, high-luster polished and coated matte black or with a silver satin finish. Round, black, polyamide multipurpose glides for all types of flooring. For wooden floorings (e. g. parquet) please order with extra felt insert. Optionally with casters. Twin-wheel swivel casters with load-dependent braking, made of black polyamide compliant with DIN EN 12529 as the standard version for carpets; with gray soft polyurethane tare for hard floors. These casters change the seating height or adjustment range to 45 – 51 cm. The gas lift is covered by bright chrome-plated protective tube, coated matte black or with a silver satin finish. When the star base is aluminum high-luster polished, the protective tube is bright chrome-plated. V-shaped die-cast aluminum support, high-luster polished like the star base, coated matte black or with a silver satin finish. Lever for adjusting the seating height, coated matte black or with a silver satin finish. When the star base is aluminum high-luster polished, the lever is bright chrome-plated.

Seat and backrest

Unitary seat and backrest shell made of molded plywood and covered on the rear. Liner made of padded cut foam. Management grade upholstery also with facing all the way round and with quilted stitching.

Armrests

Armrests made of die-cast aluminum to match the frame design, optionally with an extra armrest pad made of plastic. Management-grade variant optionally with leather-covered armrest pads, when the chair is covered in fabric in leather 74/99 black, when covered in leather in the same color and leather.

Standards

The Sola conference chairs comply with the DIN EN 16139-L1 and ANSI/BIFMA X5.1 standards.



Information

The die-cast aluminum armrests scratch easily.

Conference chairs

Star base, V-shaped support, armrests

- 60 Coated with a silver satin finish (RAL9006)
- 72 High-luster polished aluminum
- 80 Coated black matte (RAL9005)
- 90 Coated with a black textured matte finish (RAL9011)

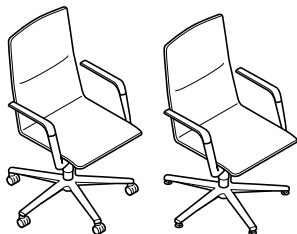
Protective tube, lever for gas lift

- Coated with a silver satin finish
- Bright chrome-plated
- Black with a matte coating (RAL9005)
- Coated with a black textured matte finish (RAL9011)



Medium-height backrest

□101/110 □H67 □H68
□44/53 □48 □44



291/7

Fully upholstered unitary seat and backrest shell,
with armrests,
precision-adjustable height
Aluminum coated frame

Additional charge/reduced prices

Plastic armrest pad

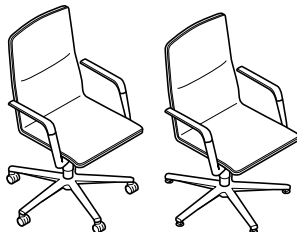
High-luster polished aluminum frame

Casters (45–51 cm seating height)

	60	64	65	66	68
	51	64	65	91	74
	56	68	68	92	74
SEK	SEK	SEK	SEK	SEK	SEK
22813	23450	24738	28638		
800	800	800	800		
775	775	775	775		
625	625	625	625		

Medium-height backrest

□101/110 □H67 □H68
□44/53 □48 □44



291/71

Seat and backrest with management grade
upholstery,
with armrests,
precision-adjustable height
Aluminum coated frame

Additional charge/reduced prices

Plastic armrest pad

Leather-covered armrest pad

High-luster polished aluminum frame

Casters (45–51 cm seating height)

	60	64	65	66	68	87
	51	64	65	91	74	87
	56	68	68	92	74	87
SEK	SEK	SEK	SEK	SEK	SEK	SEK
24413	25213	26488	30975	37238		
800	800	800	800	800	800	800
2063	2063	2063	2063	2063	2063	2063
775	775	775	775	775	775	775
625	625	625	625	625	625	625

296 Range Decide

Design: Wilkhahn



Technical details

Function

The durable conference chair fuses superior comfort with crisp design, a top quality appeal plus a wide range of models. Combined with the adjustable rocking mechanism, the shell shape of the backrest in particular means that the chair supports ergonomic dynamic sitting. Otherwise, an innovative, particularly attractive, three-dimensional rocking spring stimulates healthy movement without any mechanical parts. Three backrest heights, two frame variants, as well as four types of ring-shaped armrests and a wide range of upholstery materials ensure a wide spectrum of uses and design options for meeting spaces to boardrooms.

Base frame

Models 296/1, 296/2 and 296/3

Four-star, die-cast aluminum base, optionally coated with a silver satin finish, black or white with a textured matte finish, or high-luster or matte-polished. A DIN EN 1335-1 compliant gas lift for precision-adjustable sitting heights, black, or optionally chrome-plated when coated white with a textured matte finish or high-luster polished star base. Optionally with swivel-return mechanism, which then means only a fixed seating height of 450 mm (always with chrome-plated swivel-mounted column).

Multipurpose glides made of black plastic for all types of flooring, on request with an extra felt insert (please state when ordering). Optionally with base glides with a larger contact area made of black polyamide for all types of flooring. For wooden flooring (e.g. parquet) please order with an extra felt insert.

Models 296/4, 296/5 and 296/6

Five-star, die-cast aluminum base, optionally coated with a silver satin finish, black or white with a textured matte finish, or high-luster or matte-polished. A DIN EN 1335-1 compliant gas lift for precision-adjustable sitting heights, black, or optionally chrome-plated when coated white with a textured matte finish or high-luster polished star base. Ring-type casters with load-dependent braking as a stylish, axle-less version, made of DIN EN 12529 compliant black polyamide as the standard version for carpets; with gray polyurethane tire for hard flooring.

Both frame variants as a standard with a three-dimensional rocking mechanism made of springy high-performance steel coated in black or white with a textured matte finish or a silver satin finish. Lever made of steel coated black, made of white coated steel when the star base is coated white with a textured matte finish.

Optionally with a rocking mechanism with customized weight adjustment, mechanism shell made of aluminum, coated black, optionally polished when the star base is white with a textured matte finish or high-luster polish, with the top cover made of black polypropylene. Black polyamide lever for precision-adjustable height.

Seat and backrest

Unitary seat and backrest shell made of FSC-compliant, molded plywood, covered with polyurethane molded foam. Unitary covers with double saddle stitching, held in place with clamps in the cushions, replaceable.

Optionally with soft padding in the seat and extra cut foam added.

Armrests

Ring-shaped armrest made of die-cast aluminum, surface the same as the frame design.

Optionally with embedded armrest pad made of black, through-dyed polycarbonate, leather-covered armrest pad when the chair has fabric covers in black leather 74/99, color-matched with leather covers, or with an integrated armrest pad made of solid oak, with a natural varnished finish or stained black and varnished (please state on order).

Standards

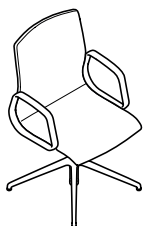
The Decide conference chairs comply with the DIN EN 16139, DIN EN 1728 and ANSI/BIFMA X5.1 standards.

Task chairs	Star base	Armrests	3D suspension	Synchro-adjustment mechanism	Gas lift	Swivel-mounted column
60	Coated with a silver satin finish (RAL9006)	Coated with a silver satin finish	Coated with a silver satin finish	Coated black	Black	Bright chrome-plated
72	High-luster polished aluminum	High-luster polished aluminum	Coated with a black textured matte finish (RAL9011)	Coated black	Black	Bright chrome-plated
72	High-luster polished aluminum	High-luster polished aluminum	Coated with a black textured matte finish (RAL9011)	High-luster polished aluminum	Bright chrome-plated	Bright chrome-plated
79	Matte-polished aluminum	Matte-polished aluminum	Coated with a black textured matte finish (RAL9011)	Coated black	Black	Bright chrome-plated
90	Coated with a black textured matte finish (RAL9011)	Coated with a black textured matte finish (RAL9011)	Coated with a black textured matte finish (RAL9011)	Coated black	Black	Bright chrome-plated
91	Coated white with a textured matte finish (RAL9016)	Coated white with a textured matte finish (RAL9016)	Coated white with a textured matte finish (RAL9016)	Coated black	Black	Bright chrome-plated
91	Coated white with a textured matte finish (RAL9016)	Coated white with a textured matte finish (RAL9016)	Coated white with a textured matte finish (RAL9016)	High-luster polished aluminum	Bright chrome-plated	Bright chrome-plated



Standard height backrest

▣95/105 ▣72 ▣72
▣42/52



296/1

Four-star base, precision-adjustable height
Fully upholstered unitary seat and backrest shell
3D suspension or optional mechanism for manual
weight adjustment
without armrests
Aluminum coated base frame
Aluminum base frame, high-luster or
matte-polished

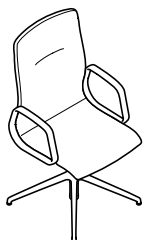
Additional charge/reduced prices

Soft padding
Ring-shaped armrest
Ring-shaped armrest with plastic pad
Ring-shaped armrest with leather covering
Ring-shaped armrest with wooden armrest pad
Swivel-return mechanism (then not
height-adjustable)
Base glides

		51	60				
		54	64		91	74	87
		56	65		92		
		66	66				
		68	68				
38	47						
SEK	SEK	SEK	SEK	SEK	SEK	SEK	SEK
11575	11725	11813	12000	12825	15538	21388	
11925	12075	12163	12350	13175	15888	21738	
325	325	325	325	325	325	325	325
2875	2875	2875	2875	2875	2875	2875	2875
3663	3663	3663	3663	3663	3663	3663	3663
4188	4188	4188	4188	4188	4188	4188	4188
5238	5238	5238	5238	5238	5238	5238	5238
825	825	825	825	825	825	825	825
.

Medium-height backrest

▣105/115 ▣72 ▣72
▣42/52



296/2

Four-star base, precision-adjustable height
Fully upholstered unitary seat and backrest shell
3D suspension or optional mechanism for manual
weight adjustment
without armrests
Aluminum coated base frame
Aluminum base frame, high-luster or
matte-polished

Additional charge/reduced prices

Soft padding
Ring-shaped armrest
Ring-shaped armrest with plastic pad
Ring-shaped armrest with leather covering
Ring-shaped armrest with wooden armrest pad
Swivel-return mechanism (then not
height-adjustable)
Base glides

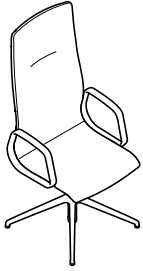
		51	60				
		54	64		91	74	87
		56	65		92		
		66	66				
		68	68				
38	47						
SEK	SEK	SEK	SEK	SEK	SEK	SEK	SEK
11850	12000	12088	12275	13100	15813	21663	
12200	12350	12438	12625	13450	16163	22013	
325	325	325	325	325	325	325	325
2875	2875	2875	2875	2875	2875	2875	2875
3663	3663	3663	3663	3663	3663	3663	3663
4188	4188	4188	4188	4188	4188	4188	4188
5238	5238	5238	5238	5238	5238	5238	5238
825	825	825	825	825	825	825	825
.

• available



High backrest

124/134 H72 H72
42/52



296/3

Four-star base, precision-adjustable height
Fully upholstered unitary seat and backrest shell
3D suspension or optional mechanism for manual weight adjustment
without armrests
Aluminum coated base frame
Aluminum base frame, high-luster or matte-polished

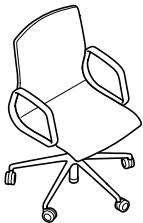
Additional charge/reduced prices

Soft padding
Ring-shaped armrest
Ring-shaped armrest with plastic pad
Ring-shaped armrest with leather covering
Ring-shaped armrest with wooden armrest pad
Swivel-return mechanism (then not height-adjustable)
Base glides

	38	47	51 54 56	60 64 65 66 68	91 92	74	87
	SEK	SEK	SEK	SEK	SEK	SEK	SEK
Aluminum coated base frame	12425	12575	12663	12850	13675	16388	22238
Aluminum base frame, high-luster or matte-polished	12775	12925	13013	13200	14025	16738	22588
Soft padding	325	325	325	325	325	325	325
Ring-shaped armrest	2875	2875	2875	2875	2875	2875	2875
Ring-shaped armrest with plastic pad	3663	3663	3663	3663	3663	3663	3663
Ring-shaped armrest with leather covering	4188	4188	4188	4188	4188	4188	4188
Ring-shaped armrest with wooden armrest pad	5238	5238	5238	5238	5238	5238	5238
Swivel-return mechanism (then not height-adjustable)	825	825	825	825	825	825	825
Base glides	•	•	•	•	•	•	•

Standard height backrest

95/105 H71/71
42/52



296/4

Five-star base, precision-adjustable height
Fully upholstered unitary seat and backrest shell
3D suspension or optional mechanism for manual weight adjustment
without armrests
Aluminum coated base frame
Aluminum base frame, high-luster or matte-polished

Additional charge/reduced prices

Soft padding
Ring-shaped armrest
Ring-shaped armrest with plastic pad
Ring-shaped armrest with leather covering
Ring-shaped armrest with wooden armrest pad

	38	47	51 54 56	60 64 65 66 68	91 92	74	87
	SEK	SEK	SEK	SEK	SEK	SEK	SEK
Aluminum coated base frame	11575	11725	11813	12000	12825	15538	21388
Aluminum base frame, high-luster or matte-polished	11925	12075	12163	12350	13175	15888	21738
Soft padding	325	325	325	325	325	325	325
Ring-shaped armrest	2875	2875	2875	2875	2875	2875	2875
Ring-shaped armrest with plastic pad	3663	3663	3663	3663	3663	3663	3663
Ring-shaped armrest with leather covering	4188	4188	4188	4188	4188	4188	4188
Ring-shaped armrest with wooden armrest pad	5238	5238	5238	5238	5238	5238	5238

• available



Medium-height backrest

▣105/115 ▣71 ▣71
▣42/52



296/5

Five-star base, precision-adjustable height
Fully upholstered unitary seat and backrest shell
3D suspension or optional mechanism for manual
weight adjustment
without armrests
Aluminum coated base frame
Aluminum base frame, high-luster or
matte-polished

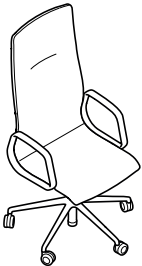
Additional charge/reduced prices

Soft padding
Ring-shaped armrest
Ring-shaped armrest with plastic pad
Ring-shaped armrest with leather covering
Ring-shaped armrest with wooden armrest pad

	38	47	51 54 56	60 64 65 66 68	91 92	74	87
	SEK	SEK	SEK	SEK	SEK	SEK	SEK
Aluminum coated base frame	11850	12000	12088	12275	13100	15813	21663
Aluminum base frame, high-luster or matte-polished	12200	12350	12438	12625	13450	16163	22013
Soft padding	325	325	325	325	325	325	325
Ring-shaped armrest	2875	2875	2875	2875	2875	2875	2875
Ring-shaped armrest with plastic pad	3663	3663	3663	3663	3663	3663	3663
Ring-shaped armrest with leather covering	4188	4188	4188	4188	4188	4188	4188
Ring-shaped armrest with wooden armrest pad	5238	5238	5238	5238	5238	5238	5238

High backrest

▣124/134 ▣71 ▣71
▣42/52



296/6

Five-star base, precision-adjustable height
Fully upholstered unitary seat and backrest shell
3D suspension or optional mechanism for manual
weight adjustment
without armrests
Aluminum coated base frame
Aluminum base frame, high-luster or
matte-polished

Additional charge/reduced prices

Soft padding
Ring-shaped armrest
Ring-shaped armrest with plastic pad
Ring-shaped armrest with leather covering
Ring-shaped armrest with wooden armrest pad

	38	47	51 54 56	60 64 65 66 68	91 92	74	87
	SEK	SEK	SEK	SEK	SEK	SEK	SEK
Aluminum coated base frame	12425	12575	12663	12850	13675	16388	22238
Aluminum base frame, high-luster or matte-polished	12775	12925	13013	13200	14025	16738	22588
Soft padding	325	325	325	325	325	325	325
Ring-shaped armrest	2875	2875	2875	2875	2875	2875	2875
Ring-shaped armrest with plastic pad	3663	3663	3663	3663	3663	3663	3663
Ring-shaped armrest with leather covering	4188	4188	4188	4188	4188	4188	4188
Ring-shaped armrest with wooden armrest pad	5238	5238	5238	5238	5238	5238	5238

30 Range Graph

Design: jehs+laub



Technical details

Function

Distinctive, high-end, standalone conference chair in two backrest heights. Armrests stylishly link the seat and backrest. Exceptional, sprung (and at the sides also elastic) comfort due to three-point support with rear spring strut and sophisticated upholstery. Can be used in traditional conference and meeting rooms, executive offices and boardrooms or prestigious dining areas.

Frame

Models 301/5, 302/5 and 304/5:
Four-star base made of die-cast aluminum, coated black or signal white, matte polished or bright chrome-plated. Black, multipurpose glides made of plastic for all types of flooring. Optionally with base glides with larger contact area for sensitive floorings, either to match the star base coated black or in signal white, matte chrome-plated (matte-polished star base) or bright chrome plated (bright chrome-plated star base). Black polyamide glides for carpets. For hard floors (e.g. stone), please order with soft TPU, for wooden floors (e.g. parquet) with additional felt. These glides change the seating height to 44 cm.
Optionally with casters for four-star bases compliant with the DIN EN 1335 and ANSI/BIFMA X 5.1 standards for conference chairs. Black polyamide twin-wheel swivel casters with load-dependent braking compliant with the DIN EN 12529 standard, with black polyurethane tire for multipurpose use on hard and soft floorings: The casters' black plastic shell comes either with a chrome-plated ring (for a coated star base), matte chrome-plated ring (for a matte polished star base) or a chrome-plated ring (for a bright chrome-plated star base). These casters change the seating height to 45 cm.

Models 301/5, 302/5 and 304/5:
Swivel-mounted column with Y-shaped seat bearer made of die-cast aluminum, coated in black or signal white, matte polished or bright chrome-plated to match the star base. Permanently elastic, rubber/metal connecting elements. Sprung elastic strut made of top-quality spring steel in black. Models 301/8, 302/8 and 304/8: Swivel-mounted column with seat bearer and integrated rocking mechanism made of die-cast aluminum and high-luster polished or matte polished.

Conference chairs	Star base	Gas lift column (models 301/7, 302/7, 301/8 and 302/8)	Synchro-adjustment mechanism (models 301/8 and 302/8)	Casters	Base glides
48	Coated white (RAL 9016)	Bright chrome-plated	High-luster polish	Black plastic shell mit chrome-plated ring	Color-matched or coated black or white
51	Bright chrome-plated	Bright chrome-plated	High-luster polish	Black plastic shell mit chrome-plated ring	Bright chrome-plated
53	Coated black (RAL 9011)	Coated black	High-luster polish	Black plastic shell mit chrome-plated ring	Color-matched or coated black or white
79	Matte-polished aluminum	Bright chrome-plated	Matte-polished aluminum	Black plastic shell with chrome-plated ring	Matte chrome-plated
90	Coated with a black textured matte finish (RAL 9011)	Coated black	High-luster polish	Black plastic shell mit chrome-plated ring	Color-matched or coated black or white
91	Coated white with a textured matte finish (RAL 9016)	Bright chrome-plated	High-luster polish	Black plastic shell mit chrome-plated ring	Color-matched or coated black or white

Awards





Models 301/6, 302/6, 304/6, 301/7, 302/7, 304/7, 301/8, 302/8 and 304/8: Die-cast aluminum five-star base coated in black or signal white, matte polished or bright chrome-plated, with casters for five-star bases compliant with the DIN EN 1335 and ANSI/BIFMA X 5.1 standards for conference chairs. Twin-wheel swivel casters with load-dependent braking made of black polyamide compliant with DIN EN 12529, with black polyurethane tire for multipurpose use on hard and soft floors: Black plastic shell for the casters either with chrome-plated ring (coated star base), matte chrome-plated ring (matte polished star base) or chrome-plated ring (bright chrome-plated star base).

All models (except for 301/8, 302/8 and 304/8) with Y-shaped seat bearer made of die-cast aluminum, coated in black or signal white, matte polished or bright chrome-plated to match the star base. Permanently elastic, rubber/metal connecting elements. Sprung elastic strut made of top-quality spring steel in black.

Models 301/6, 302/6 and 304/6 with swivel-mounted columns.

Models 301/7, 302/7, 304/7 and models 301/8, 302/8 and 304/8 with precision-adjustable seating height via a gas lift column.

Seat and backrest

Seat and backrest frame made of metal, with wave springs, fully covered in polyurethane foam with additional cushioning and replaceable textile or leather covers. Covers on the 304/5, 304/6, 304/7, 304/8 (Iconic Edition) models come with diamond-shaped top stitching and cut foam laminated on both sides and incorporated into the covers and are only available in 74/99, 74/16, 87/99, 87/85 leather.

Armrests

Armrests that connect the seat and backrest made of die-cast aluminum and to match the frame coated black or signal white, matte polished or bright chrome plated. Optionally with integrated, leather-covered armrest pads, in black 74/99 leather when the chair has fabric covers, in the same color and material in the case of leather covers.

Standards

The Graph chairs comply with the DIN EN 16139-L1 and ANSI/BIFMA X 5.1 office-chair standard.



Information

The prices for types with cushioning that includes fabrics and leather provided by the customer are given on request.



Medium-height backrest

102 62 64
43 48 47



301/5

Swivel-mounted,
fully upholstered unitary seat and backrest
frame,
with armrests
Aluminum coated frame

Additional charge/reduced prices

Leather-covered armrest pad
Swivel-return mechanism
Matte polished aluminum frame
Bright chrome-plated aluminum frame
Base glides (44 cm seating height)
Casters (45 cm seating height)

	51 56	60 64 65 66 68	91 92	74	87
	SEK	SEK	SEK	SEK	SEK
	31388	32175	33600	38238	43488
	4100	4100	4100	4100	4100
	1863	1863	1863	1863	1863
	1675	1675	1675	1675	1675
	7425	7425	7425	7425	7425
	800	800	800	800	800
	1300	1300	1300	1300	1300

High backrest

125 62 64
43 48 47



302/5

Swivel-mounted,
fully upholstered unitary seat and backrest
frame,
with armrests
Aluminum coated frame

Additional charge/reduced prices

Leather-covered armrest pad
Swivel-return mechanism
Matte polished aluminum frame
Bright chrome-plated aluminum frame
Base glides (44 cm seating height)
Casters (45 cm seating height)

	51 56	60 64 65 66 68	91 92	74	87
	SEK	SEK	SEK	SEK	SEK
	36913	38063	39825	46050	52313
	4100	4100	4100	4100	4100
	1863	1863	1863	1863	1863
	1675	1675	1675	1675	1675
	7425	7425	7425	7425	7425
	800	800	800	800	800
	1300	1300	1300	1300	1300



Medium-height backrest

104 62 64
45 48 47



301/6

Fully upholstered unitary seat and backrest frame, with armrests
Aluminum coated frame

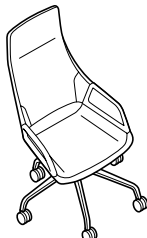
Additional charge/reduced prices

Leather-covered armrest pad
Matte polished aluminum frame
Bright chrome-plated aluminum frame

	51 56	60 64 65 66 68	91 92	74	87
	SEK	SEK	SEK	SEK	SEK
	33013	33800	35225	39863	45113
Leather-covered armrest pad	4100	4100	4100	4100	4100
Matte polished aluminum frame	1675	1675	1675	1675	1675
Bright chrome-plated aluminum frame	7425	7425	7425	7425	7425

High backrest

127 62 64
45 48 47



302/6

Fully upholstered unitary seat and backrest frame, with armrests
Aluminum coated frame

Additional charge/reduced prices

Leather-covered armrest pad
Matte polished aluminum frame
Bright chrome-plated aluminum frame

	51 56	60 64 65 66 68	91 92	74	87
	SEK	SEK	SEK	SEK	SEK
	38538	39688	41450	47675	53938
Leather-covered armrest pad	4100	4100	4100	4100	4100
Matte polished aluminum frame	1675	1675	1675	1675	1675
Bright chrome-plated aluminum frame	7425	7425	7425	7425	7425



Medium-height backrest

100/110 H 62 H 64
41/51 48 47



301/7

Fully upholstered unitary seat and backrest frame, with armrests precision-adjustable height Aluminum coated frame

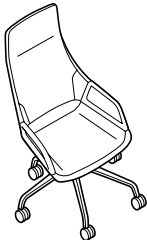
Additional charge/reduced prices

Leather-covered armrest pad
Matte polished aluminum frame
Bright chrome-plated aluminum frame

	51 56	60 64 65 66 68	91 92	74	87
	SEK	SEK	SEK	SEK	SEK
	33338	34125	35550	40188	45438
	4100	4100	4100	4100	4100
	1675	1675	1675	1675	1675
	7425	7425	7425	7425	7425

High backrest

123/133 H 62 H 64
41/51 48 47



302/7

Fully upholstered unitary seat and backrest frame, with armrests, precision-adjustable height Aluminum coated frame

Additional charge/reduced prices

Leather-covered armrest pad
Matte polished aluminum frame
Bright chrome-plated aluminum frame

	51 56	60 64 65 66 68	91 92	74	87
	SEK	SEK	SEK	SEK	SEK
	38863	40013	41775	48000	54263
	4100	4100	4100	4100	4100
	1675	1675	1675	1675	1675
	7425	7425	7425	7425	7425



Medium-height backrest

W104 H62 B64
D39/49 W47 D48



301/8

Fully upholstered unitary seat and backrest frame, with armrests, precision-adjustable height, rocking mechanism
Aluminum coated frame

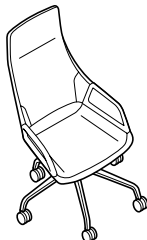
Additional charge/reduced prices

Leather-covered armrest pad
Matte polished aluminum frame
Bright chrome-plated aluminum frame

	51	60 64 65 66 68	91	74	87
	56	68	92		
	SEK	SEK	SEK	SEK	SEK
	36550	37338	38763	43400	48650
Leather-covered armrest pad	4100	4100	4100	4100	4100
Matte polished aluminum frame	1675	1675	1675	1675	1675
Bright chrome-plated aluminum frame	7425	7425	7425	7425	7425

High backrest

W123/133 H62 B64
D39/49 W47 D48



302/8

Fully upholstered unitary seat and backrest frame, with armrests, precision-adjustable height, rocking mechanism
Aluminum coated frame

Additional charge/reduced prices

Leather-covered armrest pad
Matte polished aluminum frame
Bright chrome-plated aluminum frame

	51	60 64 65 66 68	91	74	87
	56	68	92		
	SEK	SEK	SEK	SEK	SEK
	42075	43225	44988	51213	57475
Leather-covered armrest pad	4100	4100	4100	4100	4100
Matte polished aluminum frame	1675	1675	1675	1675	1675
Bright chrome-plated aluminum frame	7425	7425	7425	7425	7425



High backrest

W 125 H 62 D 64
W 43 H 48 D 47



304/5

Swivel-mounted,
unitary seat and backrest frame,
fully upholstered
with armrests
Aluminum coated frame

Additional charge/reduced prices

Leather-covered armrest pad
Swivel-return mechanism
Matte polished aluminum frame
Bright chrome-plated aluminum frame
Base glides (44 cm seating height)
Casters (45 cm seating height)

74 87

SEK SEK

53863 60125

4100 4100

1863 1863

1675 1675

7425 7425

800 800

1300 1300

74 87

High backrest

W 127 H 62 D 64
W 45 H 48 D 47



304/6

Unitary seat and backrest frame,
fully upholstered
with armrests
Aluminum coated frame

Additional charge/reduced prices

Leather-covered armrest pad
Matte polished aluminum frame
Bright chrome-plated aluminum frame

SEK SEK

55488 61750

4100 4100

1675 1675

7425 7425



High backrest

123/133 H 62 H 64
41/51 48 47



304/7

Unitary seat and backrest frame,
fully upholstered
with armrests
precision-adjustable height,
Aluminum coated frame

Additional charge/reduced prices

Leather-covered armrest pad
Matte polished aluminum frame
Bright chrome-plated aluminum frame

74 87

SEK SEK

55813 62075

4100 4100

1675 1675

7425 7425

74 87

High backrest

127/137 H 62 H 64
39/49 47 48



304/8

Unitary seat and backrest frame,
fully upholstered
with armrests
precision-adjustable height,
rocking mechanism
Aluminum coated frame

Additional charge/reduced prices

Leather-covered armrest pad
Matte polished aluminum frame
Bright chrome-plated aluminum frame

SEK SEK

59025 65288

4100 4100

1675 1675

7425 7425

300 Range Graph tables

Design: jehs+laub



Technical details

Function

A high-quality table system for traditional conference and executive workspaces.

Base frame

Table legs made of bright chrome-plated, die-cast aluminum, matte polished chrome, or coated in black or signal white. Table crossbeams/underframes made of aluminum extruded profile, color-matched with the table legs. Table top bearers to connect to the table top made of black coated steel, exception: Table top bearer is coated white when the frame is coated white. Adjustable table glides (10 mm) are made of steel, the glide cover is made of die-cast zinc, surface the same as the frame, with glide insert made of polyamide for soft floorings and polyurethane for hard floorings or with felt insert.

Table tops

Medium density fiberboard (MDF).

Table top group 2 – veneer

Table top thickness 26 mm

Variant 1:

Veneers made of beech, oak or ash based on the Wilkhahn woodstain color samples with color-matched and symmetrically curved table edge, protected with colorless natural wood varnish.

Variant 2:

Maple, walnut or elm veneer with color-matched and symmetrically curved table edge, protected with colorless natural wood varnish.



Symmetrically curved wood edging

Table top group 6 - varnished

Table top 25 mm thick, white or black varnish-coated, with color-matched and symmetrically curved table edge.



Symmetrically curved wood edging

Accessories

Cable channel

Cable channel made of aluminum extruded profile, retractable, coated black.

Cable lids, opening lengthwise and across

Cable lid opens lengthwise, beveled on both of the long sides (can be used on both sides), gas-lift-damped automatic opening mechanism, cable lid on both sides in the same color and material as the table. Cable lid: 300 x 165 mm Cable lid opens crosswise, beveled on one long side (can be used on one side), gas-lift-damped automatic opening mechanism, the cable lid is in the same material and color on both sides. Cable lid: 300 x 165 mm.

Basic cable lid

Aluminum installation frame with cable lid and brushed profile. Cable lid: 300 x 120 mm.

Vertical cable management

Flexible black cable sheath. Length including table attachment and floor panel approx. 75 cm.

Clips for holding the plastic cables, screwed to the frame leg, detachable cover made of sheet steel coated in signal white, black with a textured matte finish or dark gray with a textured matte finish.

Standards

The Graph tables comply with the DIN EN 527 and the ANSI / BIFMA X 5.5 standards.



Tables

Legs, crossbeams, underframes

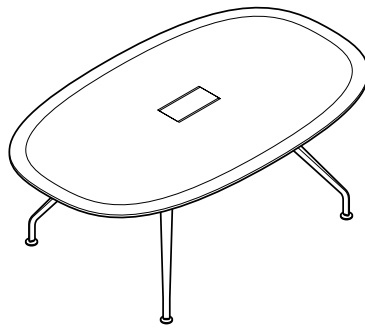
48	Coated white (RAL9016)
51	Bright chrome-plated
53	Coated black (RAL9011)
76	Matte-polished chrome
90	Coated with a black textured matte finish (RAL9011)
91	Coated white with a textured matte finish (RAL9016)

Table top bearers

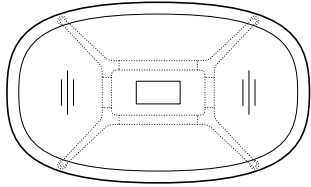
Coated white
Coated black
Coated black
Coated black
Coated with a black textured matte finish (RAL9011)
Coated white with a textured matte finish (RAL9016)

Awards





6	2	2
varnished	Veneer variant 1	Veneer variant 2
SEK	SEK	SEK

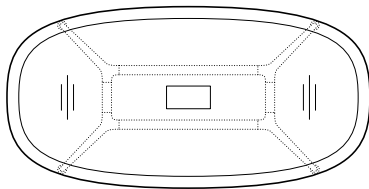


300/00
120 x 200, H73
For 6 people
Coated frame
Bright chrome-plated aluminum frame
Matte-polished chrome frame

62938	65263	66875
80425	82750	84363
85713	88038	89650

Additional charge/reduced prices

Cable channel	7150	7150	7150
Vertical cable management for the table leg	2088	2088	2088
300/011 Cable lid opening lengthwise	18275	19250	20813
300/05 1 Basic cable lid	2200	2200	2200
Socket strip, strain anchor, vertical cable management, see accessories page 105	•	•	•

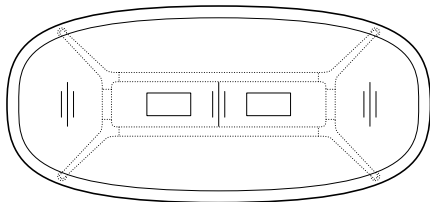


300/00
120 x 240, H 73
For 6 people
Coated frame
Bright chrome-plated aluminum frame
Matte-polished chrome frame

64938	67475	69450
83013	85550	87525
88938	91475	93450

Additional charge/reduced prices

Cable channel	7150	7150	7150
Vertical cable management for the table leg	2088	2088	2088
300/011 Cable lid opening lengthwise	18275	19250	20813
300/05 1 Basic cable lid	2200	2200	2200
Socket strip, strain anchor, vertical cable management, see accessories page 105	•	•	•



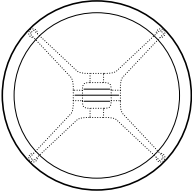
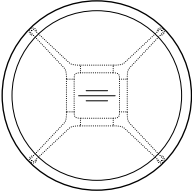
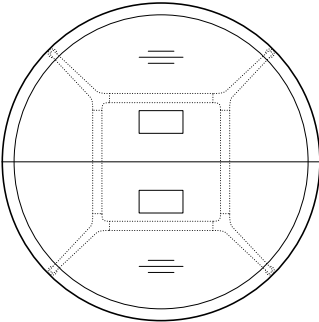
300/00
130 x 280, H 73
For 8 people
Coated frame
Bright chrome-plated aluminum frame
Matte-polished chrome frame

71238	74063	76525
91163	93988	96450
98463	101288	103750

Additional charge/reduced prices

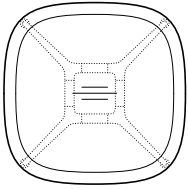
Cable channel	7150	7150	7150
Vertical cable management for the table leg	2088	2088	2088
300/012 Cable lids opening lengthwise	36550	38500	41625
300/05 2 Basic cable lids	4400	4400	4400
Socket strip, strain anchor, vertical cable management, see accessories page 105	•	•	•



		6	2	2
		varnished	Veneer variant 1	Veneer variant 2
		SEK	SEK	SEK
	300/30 Ø 125, H 73 For 4 people Coated frame Bright chrome-plated aluminum frame Matte-polished chrome frame	53788	56263	57300
		70000	72475	73513
		74213	76688	77725
	Additional charge/reduced prices Vertical cable management for the table leg	2088	2088	2088
	300/30 Ø 150, H 73 For 4 people Coated frame Bright chrome-plated aluminum frame Matte-polished chrome frame	58188	61163	62725
		75163	78138	79700
		80250	83225	84788
	Additional charge/reduced prices Vertical cable management for the table leg	2088	2088	2088
	300/40 Ø 210, H 73 For 8 people, consisting of 2 segments Coated frame Bright chrome-plated aluminum frame Matte-polished chrome frame	87675	91325	93950
		105975	109625	112250
		110350	114000	116625
	Additional charge/reduced prices Cable channel	23913	23913	23913
	Vertical cable management for the table leg	2088	2088	2088
	300/02 2 Basic cable lids open sideways	36550	38500	41625
	300/05 2 Basic cable lids	4400	4400	4400
	Socket strip, strain anchor, vertical cable management, see accessories page 105	•	•	•



6
varnished
2
Veneer variant 1
2
Veneer variant 2
SEK SEK SEK

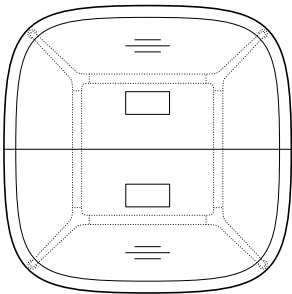


300/30
120 x 120, H 73
For 4 people
Coated frame
Bright chrome-plated aluminum frame
Matte-polished chrome frame

56188 58125 59138
72875 74813 75825
77588 79525 80538

Additional charge/reduced prices
Vertical cable management for the table leg

2088 2088 2088



300/40
190 x 190, H 73
For 8 people,
consisting of 2 segments
Coated frame
Bright chrome-plated aluminum frame
Matte-polished chrome frame

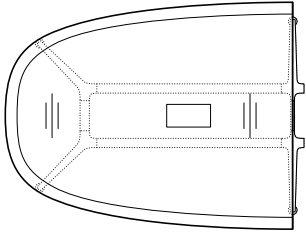
86788 90200 92850
105300 108713 111363
111463 114875 117525

Additional charge/reduced prices
Cable channel
Vertical cable management for the table leg
300/02 2 Basic cable lids open sideways
300/05 2 Basic cable lids
Socket strip, strain anchor, vertical cable management, see accessories page 105

24613 24613 24613
2088 2088 2088
36550 38500 41625
4400 4400 4400
• • •



6	2	2
varnished	Veneer variant 1	Veneer variant 2
SEK	SEK	SEK



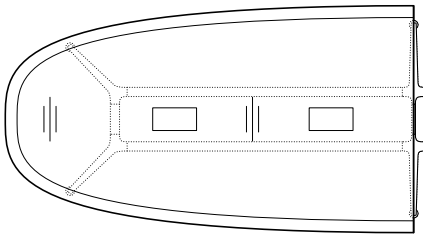
300/14
Starting element
150 x 190 H 73
Coated frame
Bright chrome-plated aluminum frame
Matte-polished chrome frame

68413	70613	72725
86363	88563	90675
92763	94963	97075

Additional charge/reduced prices

Cable channel
Vertical cable management for the table leg
300/011 Cable lid opening lengthwise siehe Seite 194
300/05 1 Basic cable lid
Socket strip, strain anchor, vertical cable management, see accessories page 105

7813	7813	7813
2088	2088	2088
18275	19250	20813
2200	2200	2200
•	•	•



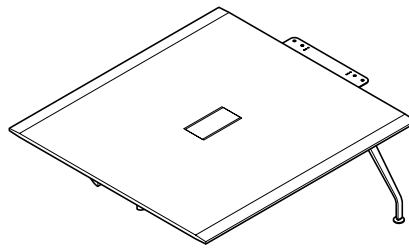
300/14
Starting element
150 x 270 H 73
Coated frame
Bright chrome-plated aluminum frame
Matte-polished chrome frame

78388	81300	84263
98700	101613	104575
106888	109800	112763

Additional charge/reduced prices

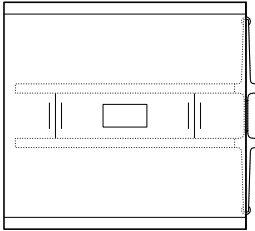
Cable channel
Vertical cable management for the table leg
300/01 1 Cable lid opening lengthwise siehe Seite 194
300/05 2 Basic cable lids
Socket strip, strain anchor, vertical cable management, see accessories page 105

7813	7813	7813
2088	2088	2088
36550	38500	41625
4400	4400	4400
•	•	•



varnished
Veneer variant 1
Veneer variant 2

SEK SEK SEK



300/16

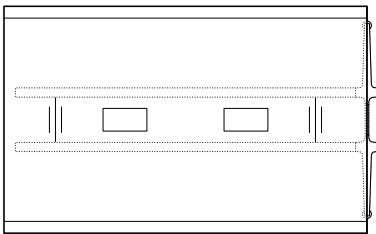
Intermediate element
150 x 160 H 73
Coated frame
Bright chrome-plated aluminum frame
Matte-polished chrome frame

54750 56950 59063
66713 68913 71025
70988 73188 75300

Additional charge/reduced prices

Cable channel
Vertical cable management for the table leg
300/01 1 Cable lid opening lengthwise siehe Seite 194
300/05 1 Basic cable lid
Socket strip, strain anchor, vertical cable management, see accessories
page 105

9650 9650 9650
2088 2088 2088
18275 19250 20813
2200 2200 2200
• • •



300/16

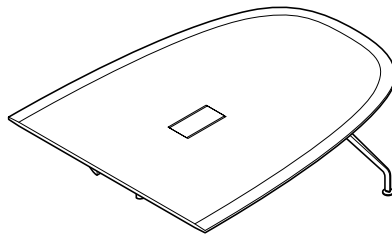
Intermediate element
150 x 240 H 73
Coated frame
Bright chrome-plated aluminum frame
Matte-polished chrome frame

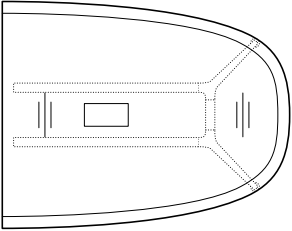
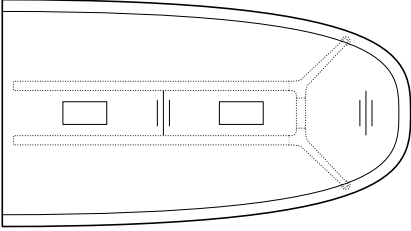
64725 67638 70600
79013 81925 84888
85113 88025 90988

Additional charge/reduced prices

Cable channel
Vertical cable management for the table leg
300/01 2 Cable lids opening lengthwise siehe Seite 194
300/05 2 Basic cable lids
Socket strip, strain anchor, vertical cable management, see accessories
page 105

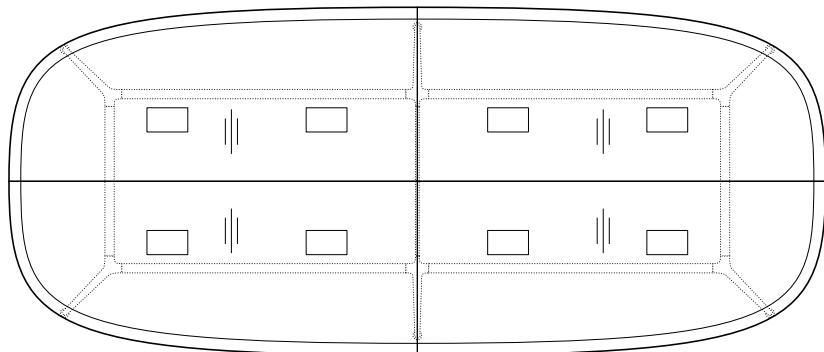
9650 9650 9650
2088 2088 2088
36550 38500 41625
4400 4400 4400
• • •



		6	2	2
		varnished	Veneer variant 1	Veneer variant 2
		SEK	SEK	SEK
	300/15 Finishing element 150 x 190 H 73 Coated frame Bright chrome-plated aluminum frame Matte-polished chrome frame	45613	47813	49925
	Additional charge/reduced prices Cable channel Vertical cable management for the table leg 300/011 Cable lid opening lengthwise siehe Seite 194 300/05 1 Basic cable lid Socket strip, strain anchor, vertical cable management, see accessories page 105	57575 61850 7813 2088 18275 2200 •	59775 64050 7813 2088 19250 2200 •	61888 66163 7813 2088 20813 2200 •
	300/15 Finishing element 150 x 270 H 73 Coated frame Bright chrome-plated aluminum frame Matte-polished chrome frame	55588	58500	61463
	Additional charge/reduced prices Cable channel Vertical cable management for the table leg 300/01 2 Cable lids opening lengthwise siehe Seite 194 300/05 2 Basic cable lids Socket strip, strain anchor, vertical cable management, see accessories page 105	69875 75975 7813 2088 36550 4400 •	72788 78888 7813 2088 38500 4400 •	75750 81850 7813 2088 41625 4400 •



varnished	Veneer variant 1	Veneer variant 2
SEK	SEK	SEK



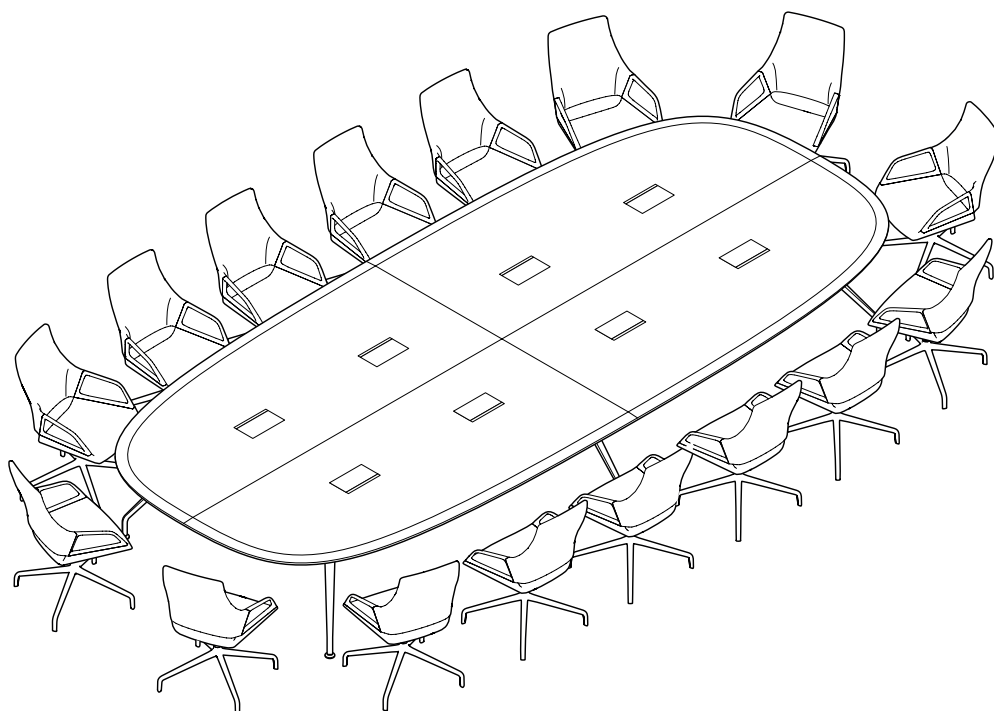
300/25
230 x 540, H 73
For 16 people,
consisting of 4 segments
Coated frame
Bright chrome-plated aluminum frame
Matte-polished chrome frame

208800	216450	225450
252863	260513	269513
269975	277625	286625

Additional charge/reduced prices

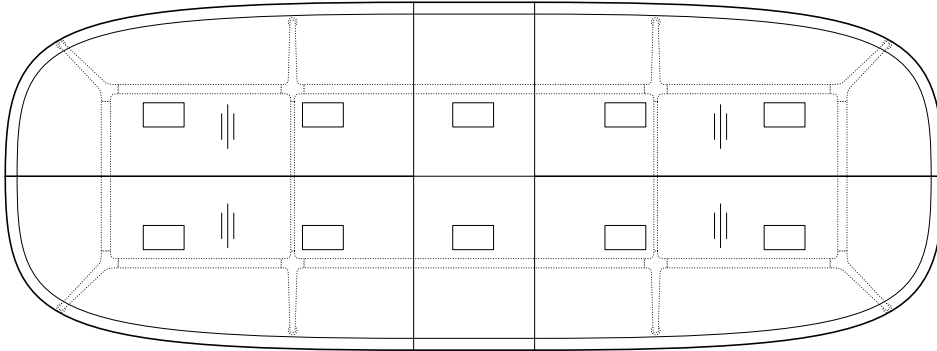
Cable channel
Vertical cable management for the table leg
300/02 8 Cable lids open sideways
300/05 8 Basic cable lids
Socket strip, strain anchor, vertical cable management, see accessories page 105

61788	61788	61788
2088	2088	2088
146200	154000	166500
17600	17600	17600





6	2	2
varnished	Veneer variant 1	Veneer variant 2
SEK	SEK	SEK



300/26

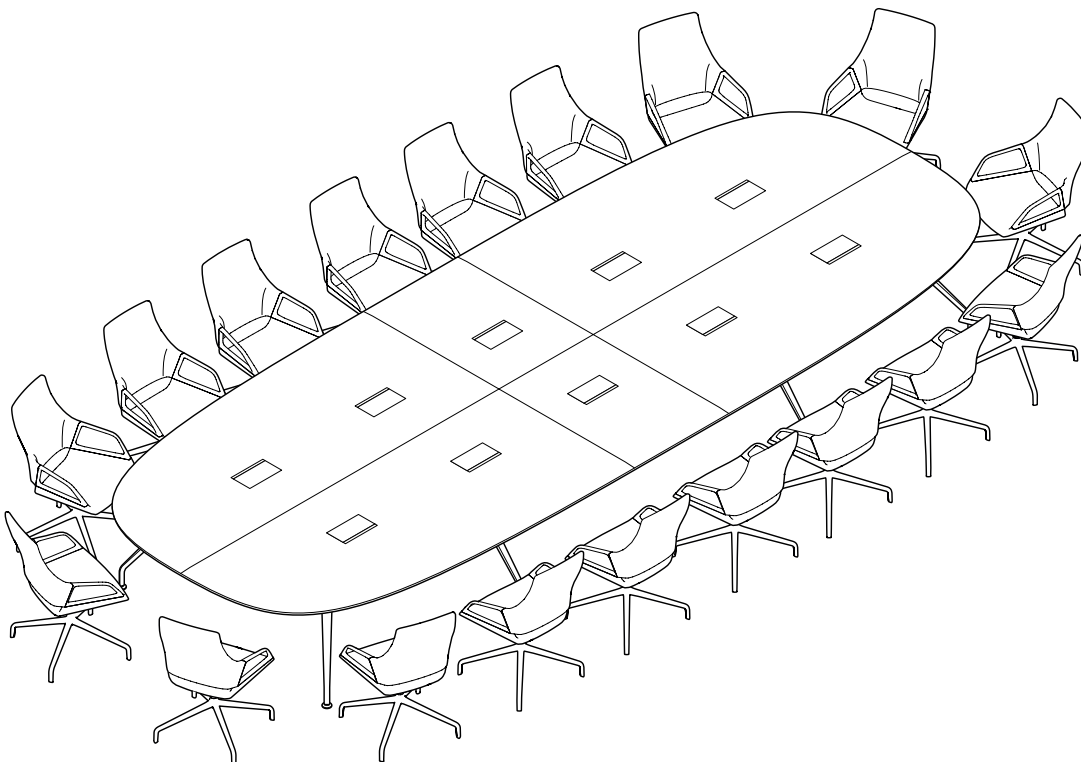
230 x 620, H 73
For 18 people,
consisting of 6 segments
Coated frame
Bright chrome-plated aluminum frame
Matte-polished chrome frame

264325	274975	283513
313413	324063	332600
332988	343638	352175

Additional charge/reduced prices

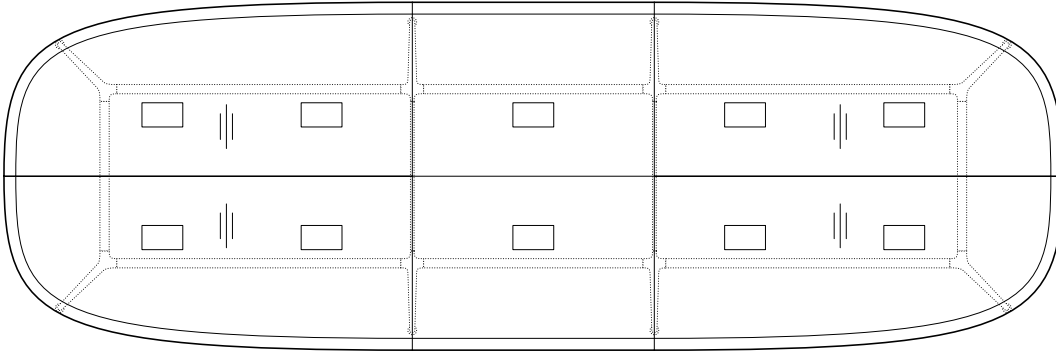
Cable channel
Vertical cable management for the table leg
300/02 10 Cable lids open sideways
300/05 10 Basic cable lids
Socket strip, strain anchor, vertical cable management, see accessories page 105

64300	64300	64300
2088	2088	2088
182750	192500	208125
22000	22000	22000
•	•	•





varnished 6	2	2
	Veneer variant 1	Veneer variant 2
SEK	SEK	SEK



300/27

230 x 700, H 73
For 20 people,
consisting of 6 segments
Coated frame
Bright chrome-plated aluminum frame
Matte-polished chrome frame

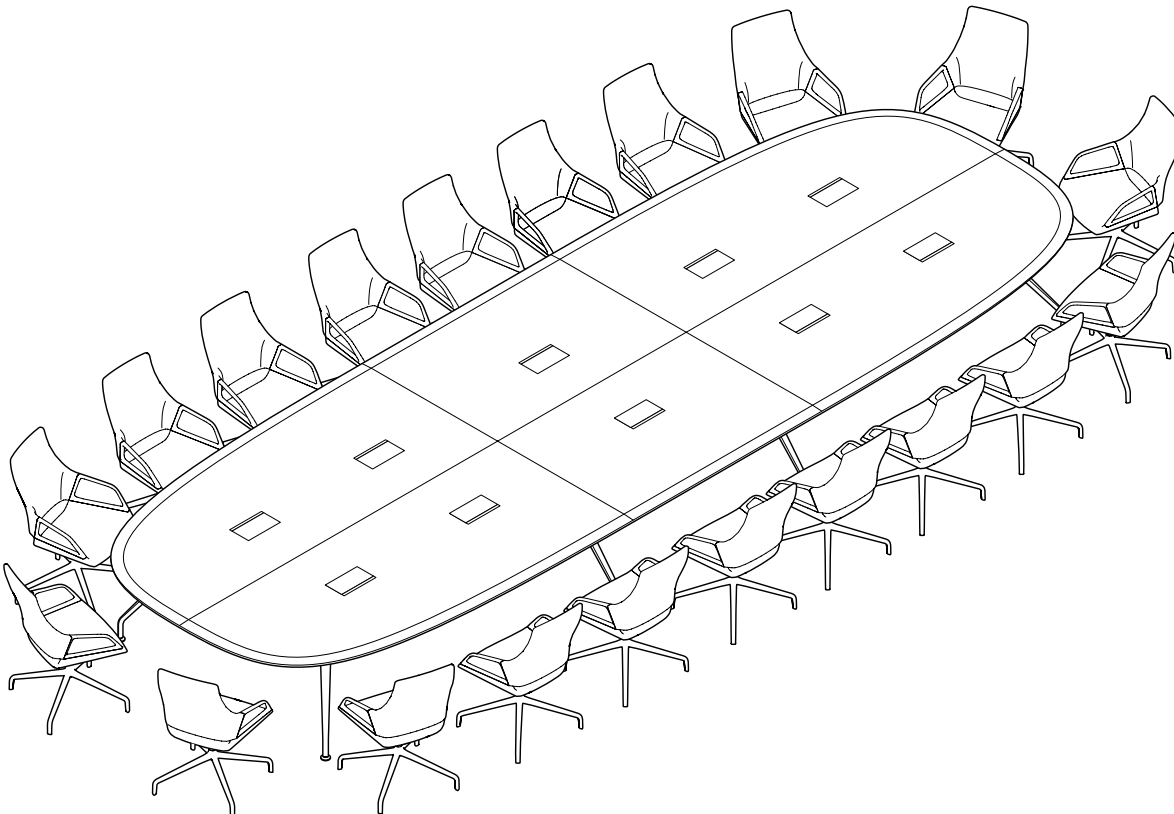
280138	291438	301325
331288	342588	352475
356100	367400	377288

Additional charge/reduced prices

Cable channel
Vertical cable management for the table leg
300/02 10 Cable lids open sideways
300/05 10 Basic cable lids
Socket strip, strain anchor, vertical cable management, see accessories
page 105

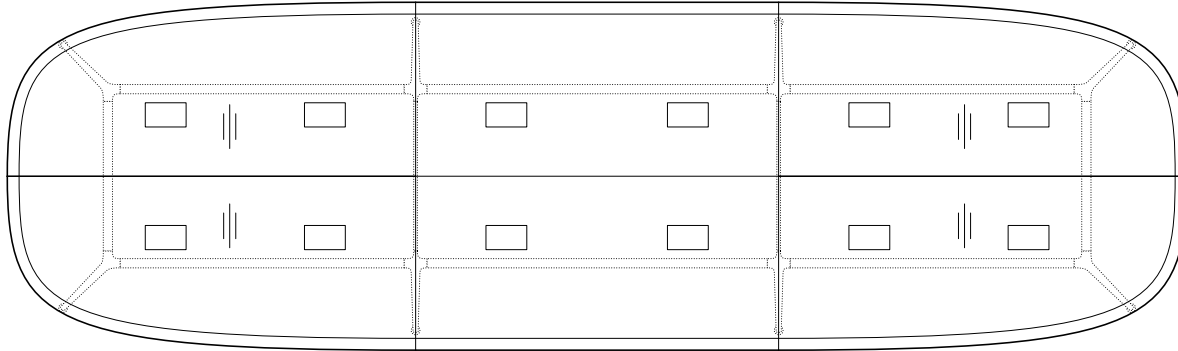
68875	68875	68875
2088	2088	2088
182750	192500	208125
22000	22000	22000

• • •





6	2	2
varnished	Veneer variant 1	Veneer variant 2
SEK	SEK	SEK



300/28

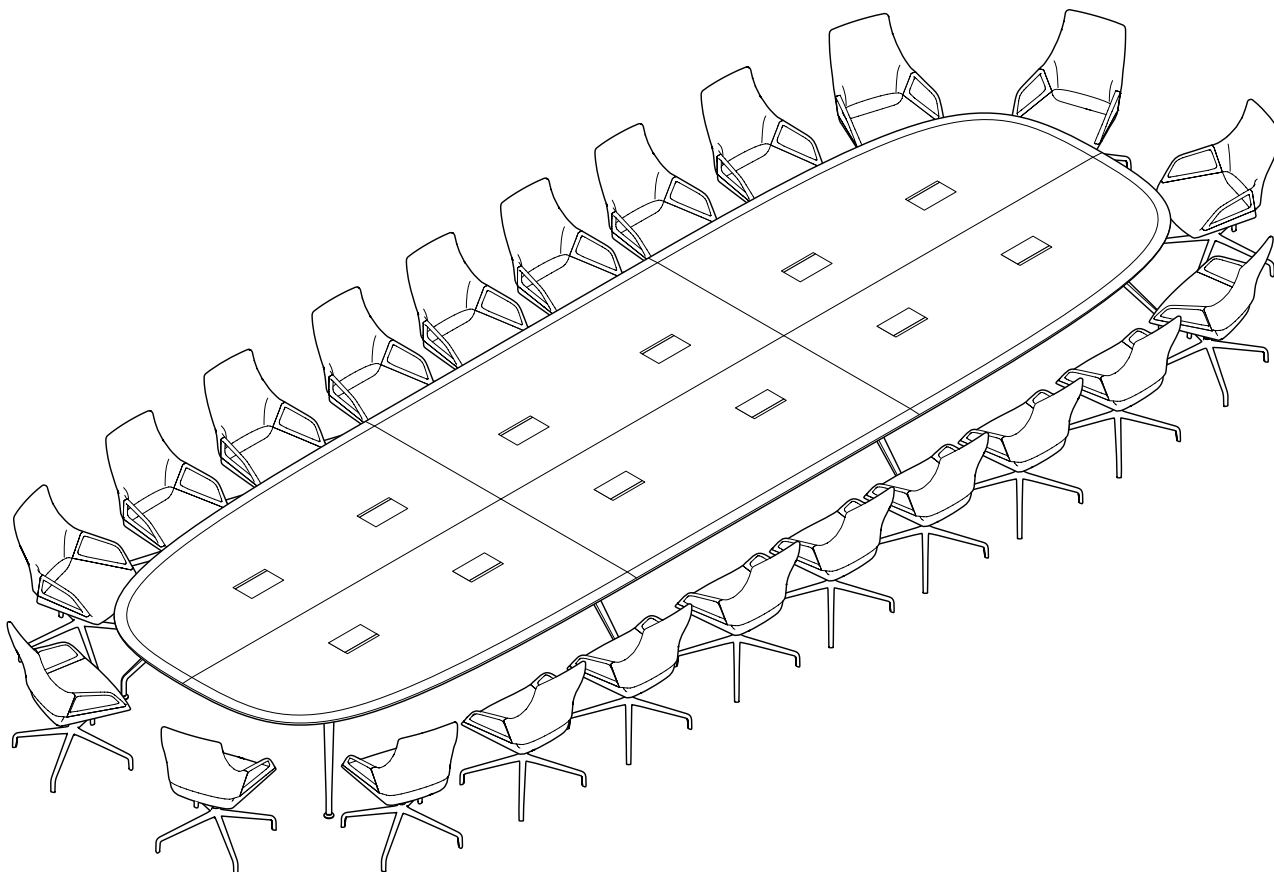
230 x 780, H 73
For 22 people,
consisting of 6 segments
Coated frame
Bright chrome-plated aluminum frame
Matte-polished chrome frame

293975	306188	318075
348588	360800	372688
377075	389288	401175

Additional charge/reduced prices

Cable channel
Vertical cable management for the table leg
300/02 12 Cable lids open sideways
300/05 12 Basic cable lids
Socket strip, strain anchor, vertical cable management, see accessories page 105

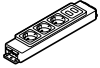
71063	71063	71063
2088	2088	2088
219300	231000	249750
26400	26400	26400





SEK

Socket strip



300/03

with insertion plates and strain anchor*, with 4 modules, 3 x power supply modules, 1 x data module with 2 x RJ45 connectors. When ordering state local standard
When ordering state local standard
* incl. fastening material and supply lead for electricity (300 cm)

4950

Socket strip



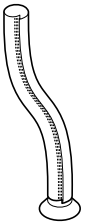
300/04

with insertion plates and strain anchor*, with 4 modules, 2 x power supply modules, 1 x data module with 2 x RJ45 connectors, 1 x slot with HDMI jack
When ordering please state local standard
* incl. fastening material and supply lead for electricity (300 cm)

10463

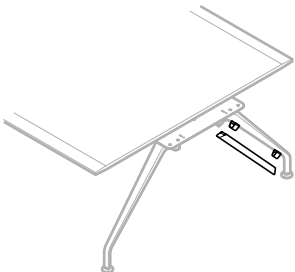
Vertical cable management

300/051



2688

Vertical cable management for the table leg



Clips for holding the plastic cables, screwed to the frame leg, detachable cover made of sheet steel coated in signal white, black with a textured matte finish or dark gray with a textured matte finish. Retrofittable on request.

2088

Strain anchor for cable channel



300/06

with insertion plate (2 items)
* incl. fastening material

738

320 Range Yonda

Design: neunzig°design



Technical details

Function

Exceptionally sustainably designed, multipurpose shell chair range with various frame variants for meeting and conference rooms, waiting areas, meeting spaces, bistros and cafeterias, hotel rooms and homes. The chair is exceptionally comfortable thanks to its breathable upholstery materials and 3D suspension. What's more, the fully upholstered shell-structure chair requires virtually no adhesives. As a result, all components can be sorted according to type at the end of the product's life.

Base frame

Four-leg frames models 320/10, 320/11, 320/12

Tubular steel frame with textured matte finish, coated in black, cream white, gray, gray-beige, emerald green, sienna red or with bright chrome plating (with environmentally friendly chromiumIII oxide). With multipurpose glides made of glide-friendly, black PA 6 (with Teflon) for soft and hard floorings. For sensitive flooring, please order with felt insert (at no additional charge).

Solid wood four-leg frame, models 320/20, 320/21, 320/22

Seat bearer made of steel plate with steel rods coated in black with a textured matte finish (RAL 9011), to fit the seat shell onto, as well as for the four legs made of FSC-compliant solid oak with an natural oiled finish. With multipurpose glides made of glide-friendly, black PA 6 (with Teflon) for soft and hard floorings. For sensitive flooring, please order with felt insert (at no additional charge).

Four-star base models 320/30, 320/31, 320/32

Four-star base made of die-cast aluminum, coated with a textured matte finish in black cream white, gray, gray-beige, emerald green, sienna red, or high-luster polished, with a concealed, in-built, swivel-mounted column made of two-part round steel tubing, coated black, optionally with a reset mechanism. Seat bearer made of molded flat steel with tapered steel connecting joint, coated in black with a textured matte finish (RAL 9011) or color-matched with the shell in a textured matte finish (additional charge). Optionally with a three-dimensional rocking mechanism made of springy flat steel coated with a black textured matte finish (RAL 9011) or color-matched with the shell in a textured matte finish (additional charge).

With steel base glides coated black with a textured matte finish (RAL 9011), color-matched with the shell in a textured matte finish (additional charge) with an integrated gliding surface made of Teflon-coated rubber for hard and soft floors, optionally with a felt insert for sensitive floors.

Optionally with twin-wheel swivel casters with load-dependent braking, made of black polyamide compliant with DIN EN 12529 as the standard version for carpets; with gray soft polyurethane tire for hard floors.

Five-star base, models 320/00, 320/01, 320/02

Five-star base in die-cast aluminum, coated with a textured matte finish in black, cream white, gray, gray-beige, emerald green, sienna red or high-luster polished, with a gas lift with precision-adjustable height, bright chrome-plated or coated black with lever made of steel rod, coated black.

Seat bearer made of molded flat steel with cylindrical connecting joint, coated in black with a textured matte finish (RAL 9011) or color-matched with the shell in a textured matte finish (additional charge).

Optionally with a three-dimensional rocking mechanism made of springy flat steel coated black with a textured matte finish (RAL 9011) or color-matched with the shell in a textured matte finish (additional charge).

Twin-wheel swivel casters with load-dependent braking, made of black polyamide compliant with DIN EN 12529 as the standard version for carpets; with gray soft polyurethane tire for hard floors.

Seat and backrest

Unitary, ergonomically molded seat shell with armrests made of Biocomposite (70% recycled polypropylene, 30% wood fibers from waste wood). Extra seat cushioning with CFC-free PUR foam. Backrest also comes with extra cut foam upholstery. Fully upholstered, inside with a cover made of 15-mm-thick, breathable and moisture-wicking polyester (50% of which is made from recycled fibers).

Please note

To ensure quality is maintained, we don't offer white leather (74/72). All other standard leather colors are possible.

Standards

The multipurpose Yonda Conference chairs comply with the ANSI/BIFMA X 5.1 standard.

Four-leg chairs and star bases

Base frame

- 51 Bright chrome-plated
- 72 High-luster polished aluminum
- 85 Coated gray with a textured matte finish (Pantone Cool Gray 10 C)
- 86 Coated gray-beige with a textured matte finish (Pantone 7530 C)
- 90 Coated with a black textured matte finish (RAL 9011)
- 93 Coated cream white with a textured matte finish (RAL 9001)
- 94 Coated emerald green with a textured matte finish (Pantone 5477 C)
- 95 Coated sienna red with a textured matte finish (Pantone 3523 C)

Awards



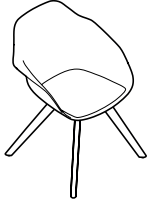
reddot award
winner





Multipurpose chair

84 60 60
44



320/20

Solid oak four-leg frame with a natural oiled finish, FSC-compliant not upholstered

SEK

5125

Accessories

320 Felt cushion with non-slip coating, available in 6 colors

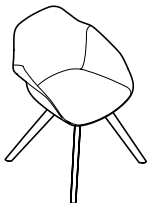
675

Upholstery material

				60			
				64			
				65			
				66	91		
				68	92	74	
	37	47	51				
	38		54				
			56				
							87

Multipurpose chair

84 60 60
44



320/21

Solid oak four-leg frame with a natural oiled finish, FSC-compliant with seat cushioning

SEK	SEK	SEK	SEK	SEK	SEK	SEK	SEK
6325	6700	6938	7175	7550	8000	8913	
463	463	463	463	463	463	463	463

Additional charge/reduced prices

Contoured upholstery

				60			
				64			
				65			
				66	91		
				68	92	74	
	38	47	51				
			54				
			56				
							87

Multipurpose chair

84 60 60
44



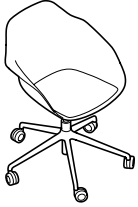
320/22

Solid oak four-leg frame with a natural oiled finish, FSC-compliant with padding on the inside

SEK	SEK	SEK	SEK	SEK	SEK	SEK
8738	9413	9800	10138	10725	12713	15463



Multipurpose chair
 81/91 H67 W67
 41/51



320/00
 Five-star base frame on casters, precision-adjustable height
 Coated frame, color-matched with the shell
 High-luster polished frame

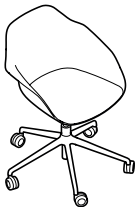
Additional charge/reduced prices
 3D suspension 675
 Frame connection color-matched with the shell 138

Accessories
320 Felt cushion
 with non-slip coating, available in 6 colors 675

Upholstery material

				60			
				64			
				65			
				66			
				68			
					91		
					92		
						74	
							87

Multipurpose chair
 81/91 H67 W67
 41/51



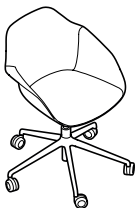
320/01
 Five-star base frame on casters, with seat cushioning, precision-adjustable height
 Coated frame, color-matched with the shell
 High-luster polished frame

Additional charge/reduced prices
 3D suspension 675
 Contoured upholstery 463
 Frame connection color-matched with the shell 138

	SEK	SEK	SEK	SEK	SEK	SEK	SEK
	8300	8675	8913	9150	9525	9975	10888
	8300	8675	8913	9150	9525	9975	10888
	675	675	675	675	675	675	675
	463	463	463	463	463	463	463
	138	138	138	138	138	138	138

				60			
				64			
				65			
				66			
				68			
					91		
					92		
						74	
							87

Multipurpose chair
 81/91 H67 W67
 41/51



320/02
 Five-star base frame on casters, with padding on the inside, precision-adjustable height
 Coated frame, color-matched with the shell
 High-luster polished frame

Additional charge/reduced prices
 3D suspension 675
 Frame connection color-matched with the shell 138

	SEK	SEK	SEK	SEK	SEK	SEK	SEK
	10713	11388	11775	12125	12700	14688	17438
	10713	11388	11775	12125	12700	14688	17438
	675	675	675	675	675	675	675
	138	138	138	138	138	138	138



440 Range Confair

Design: wiege, Fritz Frenkler, Justus Kolberg.



Technische Einzelheiten

Function

Mobile, small-scale furnishing range for multifunctional communication spaces that involved dynamic, self-organized teamwork.

Side table

Base frame

Polished die-cast aluminum star base. Oval aluminum profile column with a clear anodized finish or coated in a silver satin finish, or white or black, black or white with a textured matte finish. Black polyamide casters and glides.

Table top

Table top table top group 7 - black/white through-dyed

Table top thickness 12 mm

Table top made of through-dyed HPL (High Pressure Laminate) in black or white, chamfered edging

Pinboard / whiteboard

Base frame

Feet made of polished die-cast aluminum. Glides made of black polyamide. Frame optionally with four lockable black casters.

Frame

Aluminum profile sides and braces, clear anodized or with a silver satin finish, or coated black.

Surface of pinboard

Both sides covered with gray felt. With a pinstrip made of anthracite polyether foam.

Surface of whiteboard

One wide covered with gray felt, the other side with white enameled sheet steel, magnetic, can be written on with board marker pens, can be dry wiped and used as a projection screen.

Accessories

Four-wheeled trolley

Server

Base frame

Star base in die-cast aluminum, polished or coated in a silver satin finish or black or black with a textured matte finish, or white or white with a textured matte finish, with four black polyamide twin-wheel swivel casters.

Aluminum profile column and cable management covers, clear anodized or coated to match the star base.

Black polypropylene handle.

Top shelf and box bracket

Black-coated, die-cast aluminum

Writing tablet

Sheet steel part with black textured coating.

Box

Sheet steel part with black textured coating. Body and fronts made of birch plywood.

Box with drawer

Body and fronts made of birch plywood.

Sheet steel part with black textured coating. Solid beech drawer with a natural finish, on steel runners.

Inside dimensions of drawer 37 x 37 cm. Sheet steel part with black textured coating.

Body group 1 – laminate

Panel thickness 12 mm,

laminate based on the Wilkhahn color and surface samples. Edging with a natural oiled finish.

Body group 2 – veneer

Table top thickness 12 mm

Variant 1:

Beech, oak or ash veneer based on the Wilkhahn woodstain color samples.

Variant 2:

Maple, elm or walnut veneer from the Wilkhahn woodstain color samples.

Veneer type

As a standard, the veneers are made by slip-match method.

Clear varnished, sealed surfaces:

open-pore: oak, ash, walnut, and elm veneer

closed-pore: Maple, beech veneer.

Some specific growth features possible.

Important:

Comply with the load capacity: With even load distribution, server 60 kg in total, shelves, boxes 20 kg each, box with drawer 20 kg, of which 6 kg within the drawer.



Power Server

Power Server frame

To accommodate the writing tablet, Power base (two bases per server frame max) and other system components. Star base made of die-cast aluminum, column and cable management covers made of aluminum profile, coated black or white with a textured matte finish. Black polypropylene handle. With a cable winding device made of silicone and clamping device for affixing a mains plug. With four twin-wheel swivel casters with a black polyamide tire, which are the standard version for carpets; casters available with a polyurethane tire for hard floors (please specify when ordering). Two manually lockable casters.

Panel

Panel made of black or white through-dyed HPL, 12 mm thick, 46 x 46 cm, with chamfered edging. Attached to the support made of die-cast aluminum, black or white coating with a textured matte finish.

Power base

Base with docking station to charge Mov:e Power Units (please order separately) as well as extra fitted Twist socket (230 V and USB-A + USB-C; please state local standard when ordering).

Panel made of black or white, through-dyed HPL, 12 mm, with screen made of dark gray PET felt all the way round (if the panel is black) or light gray (if the panel is white). Base support to match the panel, coated black or white with textured matte finish. Base with integrating recharging shell and adaptor to recharge Mov:e Power Units. Twist socket, opens automatically at the touch of a button. Concealed wiring on the inside and adaptor. A central supply lead (please order separately stating the local standard) feeds power to the whole system. A connecting cable can link several power bases with each other.

Duo Power base

Base with docking station to charge two Mov:e Power Units (please order separately) at the same time.

Panel made of black or white, through-dyed HPL, 12 mm, with screen made of dark gray PET felt all the way round (if the panel is black) or light gray (if the panel is white). Base support to match the panel, coated black or white with textured matte finish. Power base with two integrated charging shells and adaptors to recharge two Mov:e Power Units at the same time.

Concealed wiring on the inside and adaptors. A central supply lead (please order separately stating the local standard) feeds power to the whole system. A connecting cable can link several power bases with each other.

Mov:e Power Unit

Efficient, mobile, lithium-ion 230 Wh rechargeable battery to operate all standard office equipment, from laptops to digital flipcharts, without having to rely on power from the mains.

A swivel-mounted handle makes it a mobile item. Connection options for one 230 V mains plug, max. 150 W (CEE 7/3, please specify local standard when ordering), two USB-A charging options, max. 15 W, and two USB-C charging options, max. 60 W. Housing black or white coated. The Mov:e Power Unit can be recharged via Power bases or an adaptor (available separately) or docking station.

Lectern

Base frame

Like the server, but with two twin-wheel swivel casters and two glides made of black polyamide.

Lectern top

Birch plywood, front edge with raised black polypropylene edging.

Surfaces

Table top group 1 – laminate

Panel thickness 11 mm, laminate based on the Wilkhahn color and surface samples. Edging with a natural oiled finish.

Table top group 2 – veneer

Table top thickness 11 mm Variant 1: Beech, oak or ash veneer based on the Wilkhahn woodstain color samples. Variant 2: Maple, elm or walnut veneer from the Wilkhahn woodstain color samples.

Veneer type

As a standard, the veneers are made by slip-match method.

Clear varnished, sealed surfaces:

open-pore: oak, ash, walnut, and elm veneer

closed-pore: Maple, beech veneer.

Some specific growth features possible.

Modesty panel

Perforated steel with a silver satin finish, or coated black, white or black with a textured matte finish, or white with a textured matte finish. Unperforated top edge for company logos (115 x 426 mm max.).

Accessories

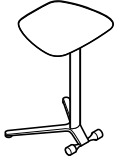
Extra shelf, width 45 cm, depth 35 cm.

Confair
Side table
Pinboard/whiteboard



Black through-dyed 7
White through-dyed 7
SEK SEK

Side table



441/2

Foot section aluminum polished and column coated
Foot section aluminum polished and column coated

6200 6563

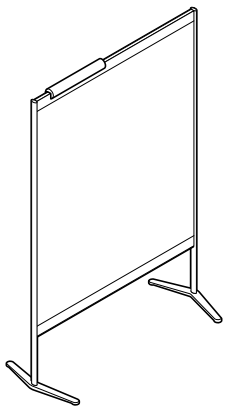
Additional charge/reduced prices

Clear anodized column

200 200

Pinboard/whiteboard

190 125 54



443/3

Whiteboards nest into one another,
one side covered with gray felt,
one side with white enameled sheet steel, magnetic,
can be written on with drywipe pens,
suitable as a projection screen,
with pinstrip model 449
Polished aluminum foot sections, coated aluminum frame

SEK

14538

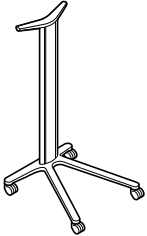
Additional charge/reduced prices

Polished aluminum foot sections, clear anodized aluminum frame
Variant with casters

575
2138



Server frame



446/00

Height 107 cm
Coated aluminum star base and column

SEK

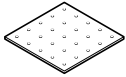
9250

Additional charge/reduced prices

Polished aluminum star base, aluminum clear anodized column

1025

Shelf



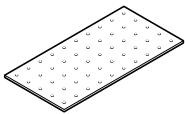
447/01

45 x 45

SEK

3938

Shelf



447/02

45 x 91

SEK

5050

Table top group

1
Laminate

2
Veneer variant 1

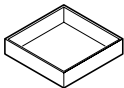
2
Veneer variant 2

SEK

SEK

SEK

Box



447/04

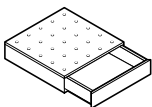
open, 45 x 45 x 10

5300

5875

6663

Box with drawer



447/07

45 x 45 x 11

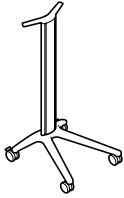
10550

11125

11913



Server frame Power



447/00

Height 107 cm
star base and column aluminum coated
with cable winder
two casters with locking device

SEK

9625

Additional charge/reduced prices

Polished aluminum star base, aluminum clear anodized column

1025

Shelf



447/11

46 x 46 cm,
Panel made of black, through-dyed HPL, chamfered edging
Panel made of white, through-dyed HPL, chamfered edging

SEK

3425

3838

Power base



447/09

Loading base for one Mov:e Power Unit*
with integrated docking station and adaptor
as well as additional in-built Twist socket 230V/USB A+C
please order supply and connection lead separately
Local standards (please state when ordering)

SEK

13475

Accessories

708/8 Supply lead Length approx. 300 cm

325

708/9 Extension lead Length approx. 100 cm

200

Duo Power base



447/10

Loading base for two Mov:e Power Units*
with two integrated docking stations and adaptor
please order supply and connection lead separately
Local standards (please state when ordering)

SEK

12100

Accessories

708/8 Supply lead Length approx. 300 cm

325

708/9 Extension lead Length approx. 100 cm

200

Mov:e Power Unit



705/10

Mobile power supply with handle
1 x power supply module CEE 7/3, max. 150 W (type F Schuko socket)
2 x USB A chargers, max. 15W, 2 x USB-C chargers, max. 60 W
body coated black or white, can be recharged on the Power base**
Local standards (please state when ordering)

SEK

Price on request

Accessories

705/12 Docking station
to recharge the Mov:e Power Unit

Price on request

705/11

Adaptor, cable length 2.5 m

Price on request

* Please order rechargeable battery separately. Details see page 191

** An adaptor is required to recharge devices not on the Power base.



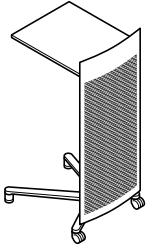
1
Laminate

2
Veneer variant 1

2
Veneer variant 2

SEK SEK SEK

Lectern



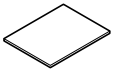
448/9
with coated modesty panel
Coated aluminum star base and column

26138 26713 27288

Additional charge/reduced prices
Polished aluminum star base, aluminum clear anodized column

1025 1025 1025

Shelf



448
for lectern model 448/9,
Width 45, depth 35

4738 4938 5513

440 Range

Confair folding table

Design: Andreas Störiko



Technical details

Function

Mobile, fold-up and linkable table range for dynamic use of conference and communication areas that users can set up themselves. Up to three meter long, barrel-shaped or rectangular tables can be opened out or collapsed in just one single step. The tables can also be linked to form conference systems using table-table connectors. Large casters allow the tables to be transported in buildings. A brake locks them in place. As a result, minimum cost and effort is required to manage conference spaces. Ideal for high-quality multipurpose conference interiors in high quality design and as a wild card in combination with the Logon table range for conference spaces with a variety of partition options, or with Timetable for sophisticated training and seminar spaces.

Frame

Foot section made of die-cast aluminum, with bright chrome plating, polished or coated with a silver satin finish, in black, white, black with a textured matte finish or white with a textured matte finish. Aluminum profile uprights and underframes, clear anodized or coated in the same colors as the foot sections. The bright chrome-plated foot sections are coated black. Upright optionally available with bright chrome plating. Connecting bar and T-shaped joint coated like the uprights and underframes, clear anodized uprights and underframes are coated with a silver satin finish. Connecting bar and T-shaped joint optionally bright chrome-plated. Lockable, black polyamide casters.

Core material of table top

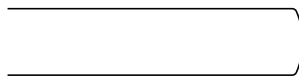
Depending on the depth of the table top, chipboard with bullnose (double) or straight wood edging all the way round with integrated impact-resilient profile made of black elastomer or with straight plastic edging all the way round. Straight version of table top without any profile along central joining edge.

Table top group 1 – laminate

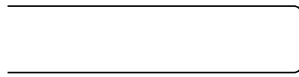
Table top thickness 26 mm

Variant 1

Laminate (single color) based on Wilkhahn's color and surface samples with wood edging, natural oiled finish or color-matched plastic edging.



Bullnose double wood edging with impact-resilient profile

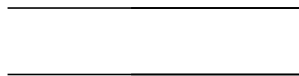


Straight wood edging with impact-resilient profile



Straight plastic edging

Wood decor laminate from the Wilkhahn color and surface samples with color-matched plastic edging.



Straight plastic edging

Folding tables	Foot section	Upright	Connecting bar	Bearers and underframes
51	Bright chrome-plated	Coated black or bright chrome-plated	Coated black or bright chrome-plated	Coated black
52	Polished aluminum	Clear anodized aluminum	Coated with a silver satin finish	Clear anodized aluminum
48	Coated white (RAL9016)	Coated white	Coated white	Coated white
53	Coated black (RAL9011)	Coated black	Coated black	Coated black
60	Coated with a silver satin finish (RAL9006)	Coated with a silver satin finish	Coated with a silver satin finish	Coated with a silver satin finish
90	Coated with a black textured matte finish (RAL9011)	Coated with a black textured matte finish (RAL9011)	Coated with a black textured matte finish (RAL9011)	Coated with a black textured matte finish (RAL9011)
91	Coated white with a textured matte finish (RAL9016)	Coated white with a textured matte finish (RAL9016)	Coated white with a textured matte finish (RAL9016)	Coated white with a textured matte finish (RAL9016)

Awards



reddot award
winner





Variant 2

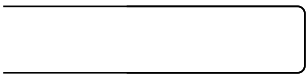
Soft matte laminate from the Wilkhahn color and surface samples with wood edging in natural oiled finish or color-matched with the plastic edging. Antireflective, antifingerprint soft touch surface.



Bullnose double wood edging with impact-resilient profile



Straight wood edging with impact-resilient profile



Straight plastic edging

Table top group 2 – veneer

Table top thickness 26 mm

Variant 1

Beech, oak, or ash veneer from Wilkhahn woodstain color samples with straight wood edging, color-matched as far as possible with the veneer.

Variant 2

Maple, elm or walnut veneer veneers from the Wilkhahn woodstain color samples with edging, color-matched with the veneer as far as possible.



Bullnose double wood edging with impact-resilient profile



Straight wood edging with impact-resilient profile

Veneer type

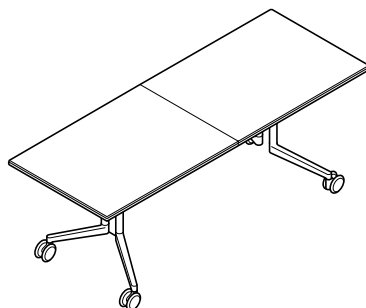
As a standard, the veneers are made by slip-match method. Surfaces sealed with clear lacquer: open-pore: Oak, walnut and elm veneer closed-pore: Maple and beech veneer. Some specific growth features possible.

Standards

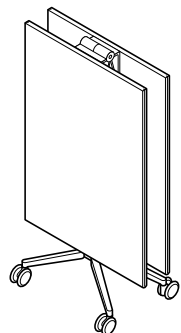
The Confair folding tables comply with the ANSI/BIFMA X 5.5 standard.

Please note

When placing repeat orders, please indicate whether your table tops have slip-matched or book-matched veneer.



Rectangular



440/00

cross veneer,
e. g. 110 x 260, H 73,
folded depth 110, width 56, height 160
Aluminum coated foot sections, uprights and underframes, coated connecting bar

SEK

Additional charge/reduced prices

Plastic lipping all the way round for laminate variant 1 (single color) and 2 **per running meter**
Polished aluminum foot sections, clear anodized uprights and underframes, connecting bar coated with a silver satin finish
Bright chrome-plated aluminum foot sections, aluminum black coated uprights and underframes, black coated connecting bar
Bright chrome-plated aluminum foot sections and uprights, aluminum black coated underframes, black coated connecting bar
Bright chrome-plated aluminum foot sections and upright, aluminum black coated underframes, bright chrome-plated connecting bar

-275

1450

2975

6600

9225

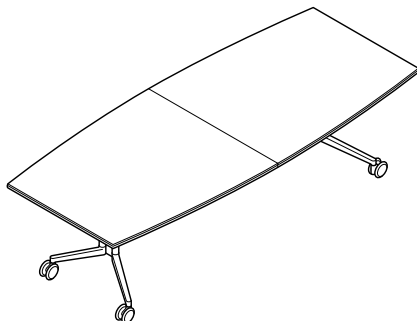
Table-table-connectors model 613, metal (2 items)

950

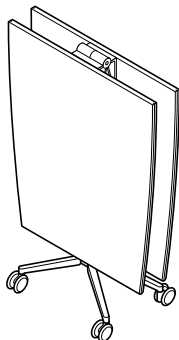
Table top group

	Width	Depth				
		90	100	105	110	120
1 Laminate variant 1	180	67800	68863	69538	70738	72738
	200	68563	69600	70775	71525	73875
	210	68913	70313	70875	71813	74088
	220	69325	70713	71563	72100	74975
	240	70088	70988	71925	73488	75988
	260	70850	71400	72713	73950	76488
	280	71613	72788	74413	75763	-
	300	72363	73263	-	-	-
1 Laminate variant 2	180	71375	72838	73750	75163	77613
	200	72563	74063	75450	76438	79288
	210	73125	75000	75825	76988	79775
	220	73725	75638	76725	77550	80963
	240	74900	76350	77563	79425	82513
	260	76075	77238	78825	80375	83538
	280	77250	79088	81063	82713	-
	300	78413	79988	-	-	-
2 Veneer variant 1	180	71888	73338	74875	75863	77700
	200	73013	74638	75913	76800	79263
	210	73588	75375	76138	77238	79725
	220	74163	75838	76975	77613	80725
	240	75288	76688	77288	79800	82888
	260	76475	77388	79350	80488	83563
	280	77563	79413	81963	83300	-
	300	78725	80100	-	-	-
2 Veneer variant 2	180	78525	80100	82250	83538	85300
	200	80200	82538	84050	85025	88038
	210	81013	83650	84325	85825	88975
	220	81863	84188	85713	86113	90650
	240	83538	85538	86488	88225	93013
	260	85200	86525	88625	90338	94113
	280	86875	89525	93375	94538	-
	300	88538	90538	-	-	-

- not available



Barrel shape



440/2

cross veneer
e. g.
90/110 x 260 H 73
folded depth 110 width 56 height 160
Aluminum coated foot sections, uprights and underframes, coated connecting bar

SEK

Additional charge/reduced prices

Plastic lipping all the way round for laminate variant 1 (single color) and 2 **per running meter**
Polished aluminum foot sections, clear anodized uprights and underframes, connecting bar coated with a silver satin finish
Bright chrome-plated aluminum foot sections, aluminum black coated uprights and underframes, black coated connecting bar
Bright chrome-plated aluminum foot sections and uprights, aluminum black coated underframes, black coated connecting bar
Bright chrome-plated aluminum foot sections and upright, aluminum black coated underframes, bright chrome-plated connecting bar

-275

1450

2975

6600

9225

Table top group

	Width	Depth	
		90/110	90/120
1 Laminate variant 1	180	-	72738
	240	-	75988
	260	73950	76488
	280	-	76900
1 Laminate variant 2	180	-	77613
	240	-	82513
	260	80375	83538
	280	-	84388
2 Veneer variant 1	180	-	77700
	240	-	82888
	260	80488	83563
	280	-	84225
2 Veneer variant 2	180	-	85300
	240	-	93013
	260	90338	94113
	280	-	95225

SEK

Cable outlet



707/1

Black plastic, Ø 80 mm

575

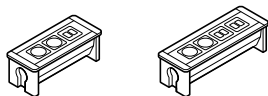
- not available



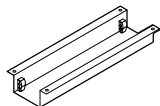
Integrated techni-station Rotate set for A1 and A3 mounting position consisting of:

SEK

Integrated techni-station rotate 701/60 or 701/70



Cable cover for techni-station



Cable clip for the table legs (2)



Integrated techni-station Rotate set 701/60 with 3 modules:

8200

2 x power supply modules (please state local standard when ordering) with supply lead, approx. 300 cm in length
1 x data module with 2 x RJ45 jacks (category 6, shielded) with permanently attached cables, approx. 350 cm in length or optionally with USB charger type A + type C with Smart IC and PD 2.0 to recharge up to two mobile devices.

Set Integrated Techni-Station Rotate 701/70 with 4 modules:

14013

2 x power supply modules (when ordering please state the local standard) with supply lead approx. 300 cm long
1 x data module with 2 x RJ45 connectors (category 6, shielded) with cables approx. 350 cm long permanently attached
1 x slot with VGA connector (15 pin D-sub) + 3.5 mm stereo jack or optionally HDMI connector with permanently attached cables, length approx. 300 cm

Additional charge/reduced prices

Techni-station with mechanism that opens by pressing the top

1250

Cable harness covered with black textile sleeving

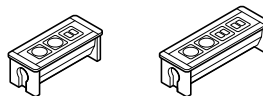
1725



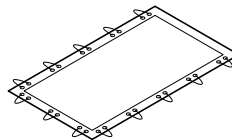
integrated techni-station Rotate set for B1 and B3 mounting position consisting of:

SEK

Integrated techni-station rotate 701/60 or 701/70



Storage mesh



Cable clip for the table legs (2)



Integrated techni-station Rotate set 701/60 with 3 modules:

12288

2 x power supply modules (please state local standard when ordering) with supply lead, approx. 300 cm in length
1 x data module with 2 x RJ45 jacks (category 6, shielded) with permanently attached cables, approx. 350 cm in length or optionally with USB charger type A + type C with Smart IC and PD 2.0 to recharge up to two mobile devices.

Integrated techni-station Rotate set 701/70 with 4 modules:

17963

2 x power supply modules (when ordering please state the local standard) with supply lead approx. 300 cm long
1 x data module with 2 x RJ45 connectors (category 6, shielded) with cables approx. 350 cm long permanently attached
1 x slot with VGA connector (15 pin D-sub) + 3.5 mm stereo jack or optionally HDMI connector with permanently attached cables, length approx. 300 cm

Additional charge/reduced prices

Techni-station with mechanism that opens by pressing the top











1250

Cable harness covered with black textile sleeving

1725





Integrated techni-station Compact set consisting of:	SEK	Integrated techni-station Compact Duo set consisting of:	SEK
<p>Round or square installation frame compact</p> 		<p>Rectangular installation frame compact duo</p> 	
<p>Multimedia</p> 		<p>Multimedia</p> 	
<p>Cable clip for the table legs (2)</p> 		<p>Cable clip for the table legs (2)</p> 	
<p>Integrated Techni-station Compact set 701/95 with port, cable outlet chrome matte, with a brushed profile</p>	850	<p>Set Integrated techni-station Compact Duo 701/96 with slot for cable outlet chrome matte, with surface with brushed strip/brushed profile*</p>	813
<p>with port, cable outlet, chrome matte, with brushed profile</p> <p>Integrated techni-station Compact set 701/95 with wireless charging port:</p>	3638	<p>with port, cable outlet, chrome matte, with brushed profile</p> <p>Integrated techni-station Compact Duo set 701/96 with wireless charging slot*:</p>	3613
<p>1 x slot with wireless charging module (5 watt, Qi compliant) with supply lead approx. 180 cm and power adapter</p> <p>Integrated techni-station Compact set 701/95 with power supply module:</p>	1600	<p>1 x slot with wireless charging module (5 watt, Qi compliant) with supply lead approx. 180 cm and power supply unit</p> <p>Integrated techni-station Compact Duo set 701/96 with power supply module*:</p>	1563
<p>1 x power supply module (when ordering please state the local standard) with 40 cm supply lead, mod. 708/8 2 x slots with cover for optional Keystone modules</p> <p>Integrated techni-station Compact set 701/95 with power supply module and USB port</p>	3375	<p>1 x power supply module (when ordering please state the local standard) with 40 cm supply lead, mod. 708/8 2 x slots with cover for optional Keystone modules</p> <p>Integrated techni-station Compact Duo set 701/96 with power supply module and USB port*:</p>	3350
<p>1 x power supply module (when ordering please state the local standard) with 40 cm supply lead, mod. 708/8 1 x USB port with Smart IC (charging current 2A max.) 1 x slot with cover for optional Keystone modules</p>		<p>1 x power supply module (when ordering please state the local standard) with 40 cm supply lead, mod. 708/8 1 x USB port with Smart IC (charging current 2A max.) 1 x slot with cover for optional Keystone modules</p>	
<p>Additional charge/reduced prices</p> <p>Keystone module RJ 45 connector (category 6) as a thru-type coupling, without cables</p>	188	<p>Additional charge/reduced prices</p> <p>Keystone module RJ 45 jack (category 6) as a thru-type coupling, without cables</p>	188
<p>Keystone module, HDMI jack as a thru-type coupling, without cables</p>	350	<p>Keystone module, HDMI jack as a thru-type coupling, without cables</p>	350
<p>708/8 supply lead</p>  <p>Length approx. 200 cm Length approx. 300 cm Length approx. 500 cm</p>	275 325 450	<p>708/8 supply lead</p>  <p>Length approx. 200 cm Length approx. 300 cm Length approx. 500 cm</p>	275 325 450
<p>Cable harness covered with black textile sleeving</p> 	1725	<p>Cable harness covered with black textile sleeving</p> 	1725



Single table portal set for Power Bar consisting of:

SEK

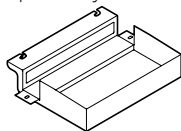
Socket strips Power Bar

SEK

Cable lid Executive or Basic



Cable channel for Power Bar mod. 704/00 and 705/00
optionally in black (RAL 9017) or white (RAL 9010)



Strain relief



Cable lid Executive set 150 x 300 mm

Table top group 1, laminate variant 1 and 2

16338

Table top group 2, veneer variant 1 and 2

19913

Basic cable lid set 120 x 300 mm

including fastening material for Power Bar socket strip, please order Power Bar separately

6363

Additional charge/reduced prices

Cable clip for the table legs (2)

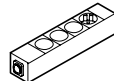


14

Mod. 704/00 Power Bar with 4 modules

2000

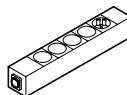
Body optionally in black or white,
with an input/output for Neutrik-powerCON® cable
1 x power supply module (when ordering please state local standard)
3 x configurable blank section



Mod. 705/00 Power Bar with 5 modules

2138

Body optionally in black or white,
with an input/output for Neutrik-powerCON® cable
1 x power supply module (when ordering please state local standard)
4 x configurable blank section



Ports for blank sections

Please note: Power and charging fields must be configured directly after one another

Power supply module (when ordering, state local standard)	275
Dual USB-A charging, 1/2 module	1675
Dual USB-C and USB-A charging, 1/2 module	3100
USB-C power charging 60W, module	4963
USB 3.0-data, Keystone module, 1/2 module	563
USB-C data (1/2 module) with approx. 30 cm cable	850
RJ45 network, CAT 6, Keystone module, 1/2 module	288
Twin network RJ45, CAT 6, Keystone module, module	475
HDMI, Keystone module, 1/2 module	1100
Blanking plate, 1/2 module	38
Blanking plate, module	50

Kabel

702/8 Neutrik-powerCON® supply lead

Length approx. 200 cm
Length approx. 300 cm
Length approx. 500 cm

600
713
1100



702/9 Extension lead Neutrik-powerCON®

Length approx. 80 cm
Length approx. 100 cm
Length approx. 150 cm
Length approx. 200 cm

925
1038
1225
1400



Patch cable CAT6, length approx. 200 cm

225

Patch cable CAT6, length approx. 300 cm

263

USB 3.0 data cable, length approx. 300 cm

288

USB type C data, connecting cable, length approx. 300 cm

400

HDMI cable, length approx. 300 cm

338



Cable lid set for A1 and A3 mounting position consisting of:

SEK

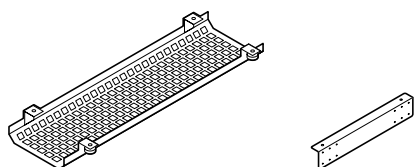
Cable lid set for M1 and M3 mounting position consisting of:

SEK

Cable lid Executive or Basic



Cable basket and mount for attaching socket strips



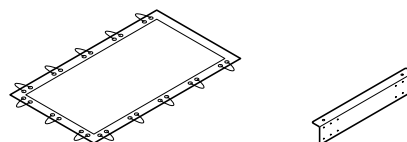
Cable clip for the table legs (2)



Cable lid Executive or Basic



Storage mesh for executive or basic cable lid for socket strip models 708/1 to 708/6



Cable clip for the table legs (2)



Executive cable lid set 150 x 300 mm

Table top group 1, laminate variant 1 and 2

15125

Table top group 2, veneer variant 1 and 2 incl. fastening material for socket strip, please order socket strip separately, can be fitted at 15° or vertically (please state angle when ordering)

18488

Basic cable lid set 120 x 300 mm

5713

incl. fastening material for socket strip, please order the socket strip separately, can be fitted vertically

Executive cable lid set 150 x 300 mm

Table top group 1, laminate variant 1 and 2

16338

Table top group 2, veneer variant 1 and 2 incl. fastening material for socket strip, please order socket strip separately, can be fitted at 15° or vertically (please state angle when ordering)

19750

Basic cable lid set 120 x 300 mm

6938

incl. fastening material for socket strip, please order the socket strip separately, can be fitted vertically

Additional charge/reduced prices

Cable harness covered with black textile sleeving

1725



Additional charge/reduced prices







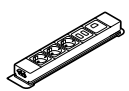
Cable harness covered with black textile sleeving

1725



Confair folding table
Built-in component sets



Socket strips for cable lid set	SEK	Cable outlet set consisting of:	SEK
Mod. 708/1 socket strip with 3 modules 3 x power supply modules (when ordering state local standard) please order supply/connecting lead separately 	788	Cable outlet 707/1 	
Mod. 708/2 socket strip with 3 modules: 2 x power supply modules (when ordering please state the local standard) Please order supply-/connecting cable separately 1 x data module with 2 x RJ45 connectors (category 6, shielded) with patch cables permanently connected, approx. 350 cm long or optionally with 1 x slot with 2 x USB ports (charging current 2.1A) to recharge up to two mobile devices 	3688	Cable clip for the table legs (2) 	
Mod. 708/4 socket strip with 4 modules: 4 x power supply modules (please state local standard when ordering) Please order supply/connecting lead separately 	925	Cable outlet set 707/1 Black plastic, Ø 80 mm	575
Mod. 708/5 socket strip with 4 modules: 2 x power supply modules (when ordering please state the local standard) please order supply/connecting cable separately 1 x data module with 2 x RJ45 jacks (category 6, shielded) with permanent patch cables approx. 350 cm long permanently attached 1 x VGA jack (15 pin D-sub) + 3.5 mm stereo jack or optionally HDMI jack with permanently attached cables, length approx. 300 cm 	9388		
Mod. 708/6 socket strip with 5 modules: 3 x power supply modules (state local standard when ordering) Please order power supply/connecting cable separately 1 x data module with 2 x RJ45 connectors (category 6 shielded) 1 x data module with 1 x RJ45 jack (category 6 shielded) with permanently attached patch cables approx. 350 cm long 	5575		

Additional charge/reduced prices

708/8 supply lead



Length approx. 200 cm	275
Length approx. 300 cm	325
Length approx. 500 cm	450

708/9 extension lead



Length approx. 200 cm	250
Length approx. 300 cm	313

Additional charge/reduced prices

Cable harness covered with black textile sleeving

1725

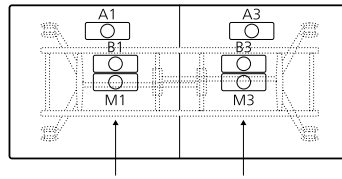


All prices include section cut out of table
 Further details from page 194



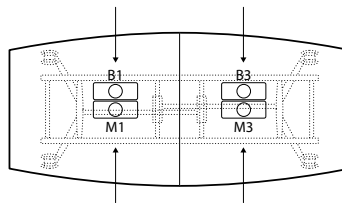
- Integrated techni-station Basic, on both sides, cable lids, integrated techni-station Compact Duo or Power Bar
- Integrated techni-station compact or cable outlet

440/00



Set	Mounting position	A1	A3	B1	B3	M1	M3
Integrated techni-station rotate 701/60 701/70		•	•	• ¹	• ¹	–	–
Cable lid Executive Basic		• ²	• ²	–	–	•	•
Integrated techni-station compact 701/95		•	•	•	•	•	•
Integrated techni-station compact duo 701/96		•	•	• ¹	• ¹	–	–
Cable outlet set 707/1		•	•	•	•	•	•
Integrated techni-station Basic, on both sides, cable lids or Power Bar		• ²	• ²	–	–	–	–

440/2



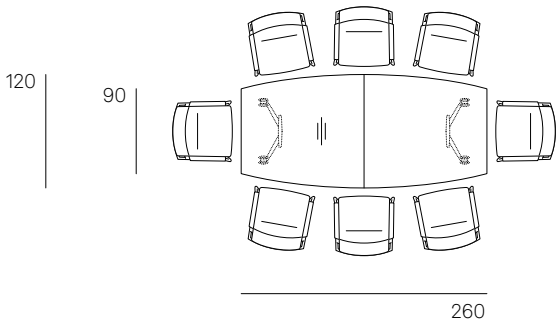
Set	Mounting position	B1	B3	M1	M3
Integrated techni-station rotate 701/60 701/70		• ³	• ³	–	–
Cable lid Executive Basic		–	–	•	•
Integrated techni-station compact 701/95		•	•	•	•
Integrated techni-station compact duo 701/96		• ³	• ³	–	–
Cable outlet set 707/1		•	•	•	•

¹ from table width 210 cm
² from table depth 105 cm
³ from table width 240 cm

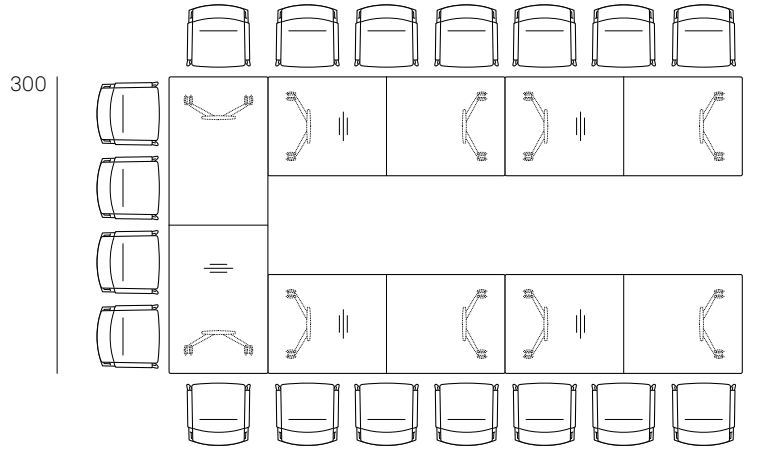
⁴ table width 180 – 200 cm (≤3 modules)
table width 205 – 220 cm (≤ 4 modules)
table width ≥ 225 cm [Übersetzung]

• available
– not available

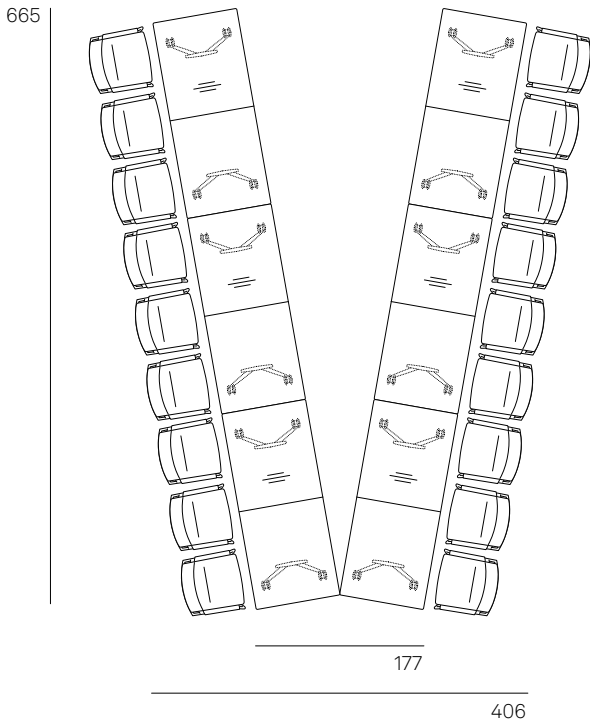
Confair folding table
Example configurations



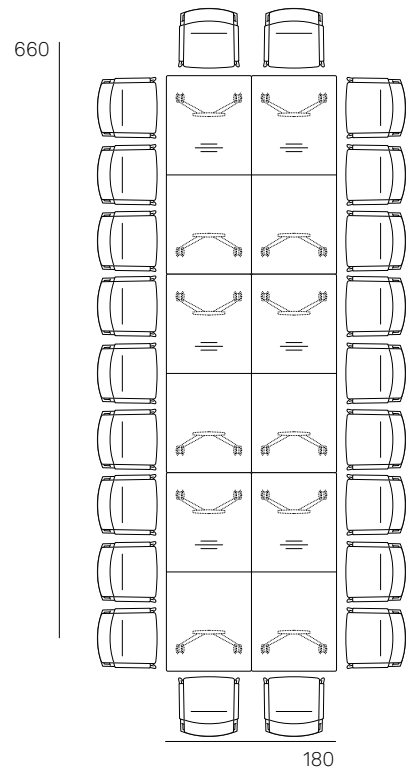
8 People
 1 x 440/2, 90/120x260



16 People
 1 x 440/00, 100x300
 4 x 440/00, 100x240



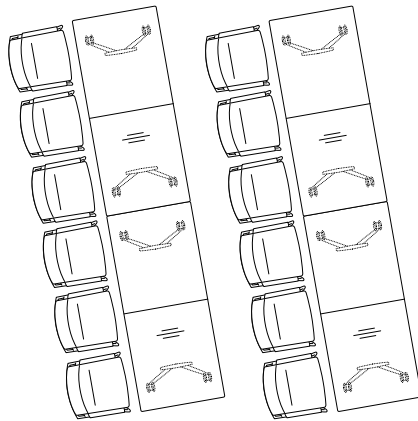
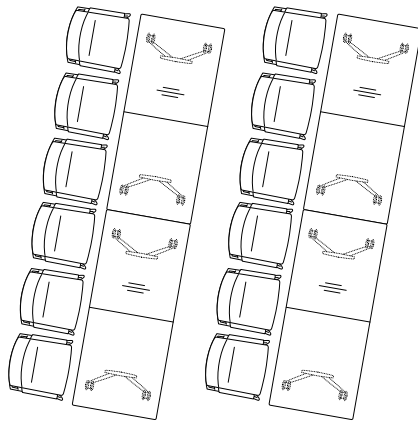
18 People
 6 x 440/00, 90x210



22 People
 6 x 440/00, 90x210



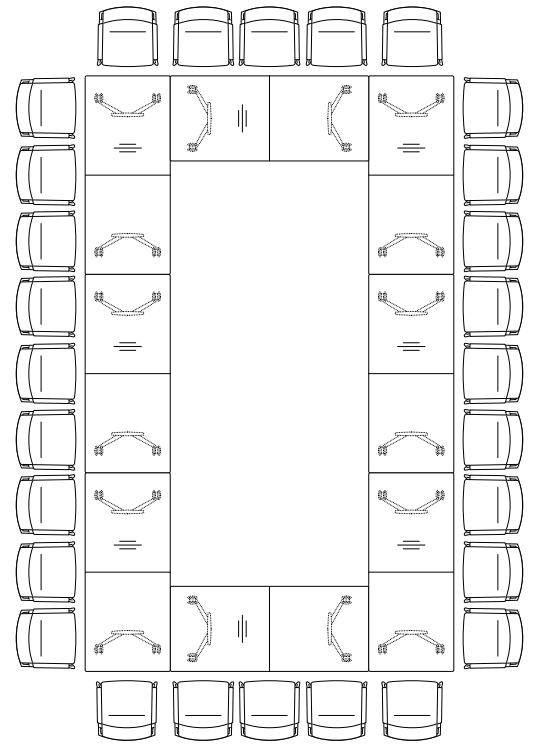
1018



375

24 People
8 x 440/00, 90x210

660



400

28 People
8 x 440/00, 90x210

460 Range mAx

Design: Andreas Störiko



Technical details

Function

The mAx folding table system offers first-class design, manual prevention of faulty handling, integrated linkage options, a self-stabilizing capability and requires just one hand to set it up. Three table foot sizes allow scalable table depths and widths to permit a broad range of design options ranging from tables in loosely arranged groups, or linked up to make rows, or arranged to form open-centered or closed conference table systems. Possible applications are versatile furnishing of conference, meeting, seminar and co-working spaces, or multipurpose restaurants and cafés

Frame

T-shaped foot, consisting of: foot section made of die-cast aluminum, coated, polished or high-luster polished with height-adjustable, non-slip multipurpose glides. Upright with pivoting mechanism made of die-cast aluminum, coated, polished or high-luster polished with integrated brace made of die-cast, high-luster polished aluminum. Pivoting mechanism with integrated stacking buffer made of black plastic and T-shaped counterbearing attached to the bottom of the table top (to insert into and lock the brace to ensure the self-stabilizing capability), made of die-cast aluminum, coated to color-match the upright or coated black if the upright is polished. In the case of system tables, also pull-out steel eyelets integrated in the folding mechanism to insert the connecting leaves into. Underframe underneath the table top made of steel profile in black.

Connecting leaves

Connecting leaves with four integrated connecting plates made of fiberglass-reinforced plastic in black and integrated steel hook to affix the system tables' metal eyelets. Knob for force-fit connections made of black fiberglass-reinforced plastic with integrated, black separator.

Core material of table top/connecting leaf

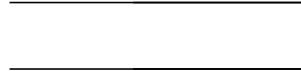
Plywood with straight wood lipping all the way round or bullnose (double) with impact-resilient profile or with plastic lipping all the way round or plywood with bonded melamine resin surface with straight, color-matched plastic lipping all the way round.

Table top group 1 – laminate

Table top thickness 26 mm

Variant 1

Laminate (single color) based on Wilkhahn's color and surface samples with wood edging, natural oiled finish, straight or optionally bullnose with an impact-resilient profile (for an additional charge)

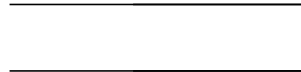


Straight wood edging



Bullnose double wood edging with impact-resilient profile

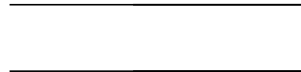
Wood decor laminate from the Wilkhahn color and surface samples with straight, color-matched plastic edging



Straight plastic edging

Variant 2

Soft matte laminate from the Wilkhahn color and surface samples with wood lipping, with a natural oiled finish, straight or optionally bullnose (double) with impact-resilient profile (for an extra charge) or with color-matched plastic lipping. Anti-reflective, soft-touch surface with anti-fingerprint characteristics.



Straight plastic edging



Straight wood edging



Bullnose double wood edging with impact-resilient profile

Tables	Foot section	Upright/pivoting mechanism	Counterbearing	Underframe and plastic components
48	Coated white (RAL 9016)	Coated white	Coated white	Black
52	Polished aluminum	Coated black, white or with a silver satin finish, or polished	Coated black	Black
53	Coated black (RAL 9011)	Coated black	Coated black	Black
60	Coated with a silver satin finish (RAL 9006)	Coated with a silver satin finish	Coated with a silver satin finish	Black
72	High-luster polished aluminum	Coated black, white or with a silver satin finish, or high-luster polished	Coated black	Black

Awards



reddot award
winner





Table top group 2 – veneer

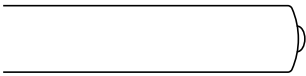
Table top thickness 26 mm

Variant 1

Beech, oak, or ash veneer from Wilkhahn woodstain color samples with straight wood lipping, color-matched as far as possible with the veneer or optionally bullnose (double) with impact-resilient profile (for an extra charge)

Variant 2

Maple, walnut or elm from the Wilkhahn woodstain color samples with straight wood lipping, color-matched with the veneer as far as possible or optionally bullnose (double) with impact-resilient profile (extra charge)



Bullnose double wood edging with impact-resilient profile



Straight wood edging

Veneer type

As a standard, the veneers are made by slip-match method. Surfaces sealed with clear lacquer:

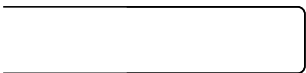
open-pore: Oak, ash, walnut and elm veneer

closed-pore: maple, beech veneer. Some specific growth features possible.

When placing repeat orders, please indicate whether your table tops have slip-matched or book-matched veneer.

Table top group 5 – direct coating

Table top thickness 25 mm, plywood with bonded melamine resin surface in white, black, light gray or dark gray with color-matched, plastic lipping all the way round



Straight plastic edging

Modesty panels

Guide bar in black underneath the table top, with black, opaque fabric, height 40 cm, can be rolled up and affixed underneath the table top with hook and loop fasteners.

Table-table-connectors (optional)

Metal table-table-connectors model 613: two lockable circlips made of black coated sheet steel with 4 star-grip screws.

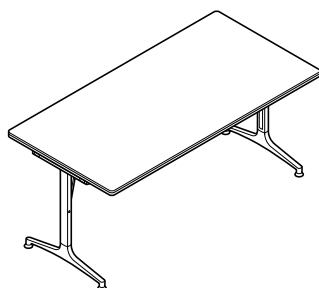
Standards

The mAx tables comply with the DIN EN 15372 standard.

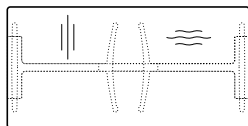


Information

Folding table's height when stacked: 107 mm
Connecting leaf's stacking height: 60 mm



Rectangular



460/00

Folding table, stackable
table height 73 cm
foot section and upright coated aluminum

SEK

Additional charge/reduced prices

Polished aluminum foot section, aluminum coated upright 588

Polished aluminum foot section and upright 1988

High-luster polished aluminum foot section, aluminum coated upright 588

High-luster polished aluminum foot section and upright 1988

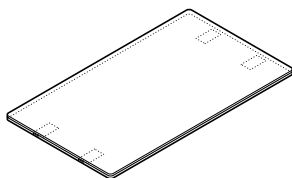
Bullnose (double) lipping all the way round with impact-resilient profile (not in the case of direct coating) **per running meter** 588

Table-table connector model 613 950

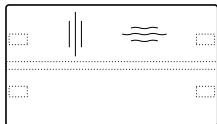
Table top group

	Width	Depth				
		60	70	75	80	90
5 Direct coating	150	10513	11188	11450	11788	12500
	160	10800	11475	11838	12800	12913
	180	11313	12100	12550	12925	13688
	200	–	12563	13125	13488	14263
	220	–	–	–	14238	15063
1 Laminate variant 1	150	12313	12988	13375	13750	14463
	160	12613	13363	13775	14138	14925
	180	13175	14025	14550	14925	15800
	200	–	14563	15175	15563	16500
	220	–	–	–	16450	17388
1 Laminate variant 2	150	14788	15850	16463	17038	18163
	160	15200	16425	17063	17675	18863
	180	16113	17488	18225	18850	20250
	200	–	18413	19263	19950	21413
	220	–	–	–	21238	22775
2 Veneer variant 1	150	17975	18475	18713	18988	19475
	160	19288	19788	20063	20325	20825
	180	19775	20325	20588	20913	21438
	200	–	20863	21225	21550	22113
	220	–	–	–	22363	23000
2 Veneer variant 2	150	19263	20000	20338	20725	21425
	160	20713	21425	21838	22175	22913
	180	21150	21938	22600	22988	23688
	200	–	22488	23275	23613	24363
	220	–	–	–	24475	25250

– not available



Square/rectangular



461/00

Connecting leaf, stackable
to extend models 460/00, 460/11 and 460/51

SEK

Additional charge/reduced prices

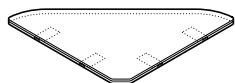
Bullnose (double) lipping all the way round with impact-resilient profile (not in the case of direct coating) **per running meter**

588

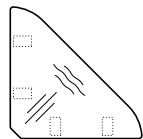
Table top group

	Width	Depth				
		60	70	75	80	90
5 Direct coating	60	4825	-	-	-	-
	70	-	5338	-	-	-
	75	-	-	5513	-	-
	80	-	-	-	5675	-
	90	-	-	-	-	6113
	120	5875	6225	6500	6813	7400
	140	5888	6500	6850	7175	7825
	160	-	6825	7188	7538	8263
1 Laminate variant 1	60	6238	-	-	-	-
	70	-	6713	-	-	-
	75	-	-	6925	-	-
	80	-	-	-	7213	-
	90	-	-	-	-	7925
	120	7125	7750	8113	8438	9200
	140	7400	8113	8500	8850	9600
	160	-	8475	8913	9263	10050
1 Laminate variant 2	60	8050	-	-	-	-
	70	-	8900	-	-	-
	75	-	-	9313	-	-
	80	-	-	-	9925	-
	90	-	-	-	-	10738
	120	9425	10475	11025	11625	12663
	140	9850	10975	11600	12200	13288
	160	-	11550	12175	12800	13988
2 Veneer variant 1	60	12063	-	-	-	-
	70	-	12400	-	-	-
	75	-	-	12538	-	-
	80	-	-	-	12700	-
	90	-	-	-	-	13025
	120	13950	13888	14088	14350	14788
	140	14413	14413	14625	14875	15375
	160	-	14913	15200	15463	15950
2 Veneer variant 2	60	12663	-	-	-	-
	70	-	13025	-	-	-
	75	-	-	13213	-	-
	80	-	-	-	13588	-
	90	-	-	-	-	13900
	120	14563	15125	15375	15750	16313
	140	15175	15838	16138	16538	17163
	160	-	16550	16950	17313	18025

- not available



Corner element 90°



461/10

Connecting leaf, stackable
to extend models 460/00 and 460/11

SEK

Additional charge/reduced prices

Bullnose (double) lipping all the way round with impact-resilient profile (not in the case of direct coating) **per running meter**

588

Table top group

	Width	Depth				
		60	70	75	80	90
5 Direct coating	95	7063	–	–	–	–
	109	–	7575	–	–	–
	116	–	–	7750	–	–
	123	–	–	–	7913	–
	137	–	–	–	–	8350
1 Laminate variant 1	95	8888	–	–	–	–
	109	–	9338	–	–	–
	116	–	–	9575	–	–
	123	–	–	–	9863	–
	137	–	–	–	–	10513
1 Laminate variant 2	95	10713	–	–	–	–
	109	–	11538	–	–	–
	116	–	–	11975	–	–
	123	–	–	–	12588	–
	137	–	–	–	–	13375
2 Veneer variant 1	95	14700	–	–	–	–
	109	–	15000	–	–	–
	116	–	–	15200	–	–
	123	–	–	–	15375	–
	137	–	–	–	–	15650
2 Veneer variant 2	95	15338	–	–	–	–
	109	–	15650	–	–	–
	116	–	–	15863	–	–
	123	–	–	–	16225	–
	137	–	–	–	–	16563

– not available



465 Range mAx light

Design: Andreas Störiko



Technical details

Function

The mAx light folding table system with its lightweight table top offers first-class design, self-stabilizing capabilities, manual prevention of faulty handling, integrated linkage options and requires just one hand to set it up. Three table foot sizes allow scalable table depths and widths to permit a broad range of design options ranging from tables in loosely arranged groups, or linked up to make rows, or arranged to form open-centered or closed conference table systems. Possible applications are versatile furnishing of conference, meeting, seminar and co-working spaces, or multipurpose restaurants and cafés

Frame

T-shaped foot, consisting of: foot section made of die-cast aluminum, coated, polished or high-luster polished with height-adjustable, non-slip multipurpose glides. Upright with pivoting mechanism made of die-cast aluminum, coated, polished or high-luster polished with integrated brace made of die-cast, high-luster polished aluminum. Pivoting mechanism with integrated stacking buffer made of black plastic and T-shaped counterbearing attached to the bottom of the table top (to insert into and lock the brace to ensure the self-stabilizing capability), made of die-cast aluminum, coated to color-match the upright or coated black if the upright is polished. In the case of system tables, also pull-out steel eyelets integrated in the folding mechanism to insert the connecting leaves into. System tables from 200 cm table length, stand-alone tables as well as starter and end table top panels from 220 cm with an underframe underneath the table top made of steel profile in black.

Connecting leaves

Connecting leaves with four integrated connecting plates made of fiberglass-reinforced plastic in black and integrated steel hook to affix the system tables' metal eyelets. Knob for force-fit connections made of black fiberglass-reinforced plastic with integrated, black separator.

Core material of the table top/connecting leaf

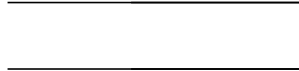
Lightweight table top with finger jointed middle section made of fast-growing lightweight wood with plastic lipping all the way round, straight or with wood lipping, straight or bullnose (double) with impact-resilient profile or with chamfered lipping (in the case of system tables with linkage option on both sides and connecting leaves with chamfered lipping on the long edges, straight joining edges, in the case of starter and end table top panels, chamfered lipping on three sides, straight joining edge, in the case of stand-alone tables chamfered lipping all the way round)

Table top group 1 – laminate

Table top thickness 30 mm

Variant 1

Laminate (single color) based on Wilkhahn's color and surface samples with wood edging, natural oiled finish, straight or optionally bullnose with an impact-resilient profile (for an additional charge)

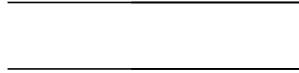


Straight wood edging



Bullnose double wood edging with impact-resilient profile

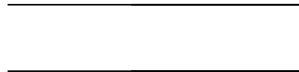
Wood decor laminate from the Wilkhahn color and surface samples with straight, color-matched plastic edging



Straight plastic edging

Variant 2

Soft matte laminate from the Wilkhahn color and surface samples with wood lipping, with a natural oiled finish, straight or optionally bullnose (double) impact-resilient profile (for an extra charge) with color-matched plastic lipping. Anti-reflective, soft-touch surface with anti-fingerprint characteristics.



Straight plastic edging



Straight wood edging



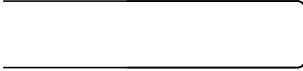
Bullnose double wood edging with impact-resilient profile

Tables	Foot section	Upright/pivoting mechanism	Counterbearing	Underframe and plastic components
48	Coated white (RAL 9016)	Coated white	Coated white	Black
52	Polished aluminum	Coated black, white or with a silver satin finish, or polished	Coated black	Black
53	Coated black (RAL 9011)	Coated black	Coated black	Black
60	Coated with a silver satin finish (RAL 9006)	Coated with a silver satin finish	Coated with a silver satin finish	Black
72	High-luster polished aluminum	Coated black, white or with a silver satin finish, or high-luster polished	Coated black	Black



Table top group 2 – veneer

Table top thickness 30 mm



Straight wood edging



Bullnose double wood edging with impact-resilient profile



Chamfered wood edging

Variant 1

Beech, oak, or ash veneer (exception: natural ash not possible with chamfered lipping) based on Wilkhahn woodstain color samples with straight wood lipping, color-matched as far as possible with the veneer or optionally bullnose (double) with impact-resilient profile (for an extra charge)

Variant 2

Maple (exception: maple with a natural finish not possible with chamfered lipping), walnut or elm veneer from the Wilkhahn woodstain color samples with straight wood lipping, color-matched as far as possible with the veneer or optionally bullnose (double) with impact-resilient profile (for an extra charge).

Veneer type

As a standard, the veneers are made by slip-match method. Surfaces sealed with clear lacquer: open-pore: Oak, ash, walnut and elm veneer closed-pore: maple and beech veneer. Some specific growth features possible. When placing repeat orders, please indicate whether your table tops have slip-matched or book-matched veneer.

Modesty panels

Guide bar in black underneath the table top, with black, opaque fabric, height 40 cm, can be rolled up and affixed underneath the table top with hook and loop fasteners.

Table-table-connectors (optional, not possible with chamfered lipping)

Metal table-table-connectors model 613: two lockable circlips made of black coated sheet steel with 4 star-grip screws.

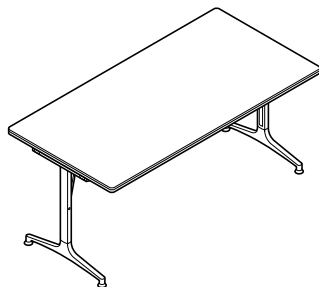
Standards

The mAx light tables comply with the DIN EN 15372 standard.

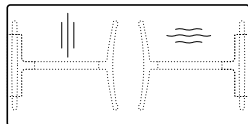


Information

Folding table's stacking height <150 cm: 120 mm
Folding table's total height when stacked ≥ 150 cm: 112 mm
Connecting leaf's stacking height: 60 mm



Rectangular



465/00

Folding table, stackable
table height 73.5 cm
coated foot section, upright and underframes

SEK

Additional charge/reduced prices

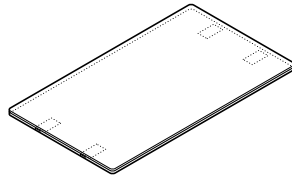
Polished aluminum foot section, aluminum coated upright	588
Polished aluminum foot section and upright	1988
High-luster polished aluminum foot section, aluminum coated upright	588
High-luster polished aluminum foot section and upright	1988
Bullnose (double) lipping all the way round with impact-resilient profile per running meter	588
Chamfered lipping on the long sides* for veneer variant 1 per running meter	800
Chamfered lipping on the long sides* for veneer variant 2 per running meter	975

Table-table connector model 613 950

Table top group

	Width	Depth					
		45	60	70	75	80	90
1 Laminate variant 1	120	14400	14600	14800	15263	15788	16800
	130	14513	14950	15350	15925	16463	17450
	140	14675	15263	15925	16550	17125	18100
	150	14988	15588	16513	17213	17700	18625
	160	15288	15913	17038	17838	18313	19288
	180	–	16563	18125	19125	19575	20700
	200	–	–	18888	19950	20588	21813
	220	–	–	–	–	21775	23063
1 Laminate variant 2	120	15925	16650	17138	17813	18450	19825
	130	16188	17125	17925	18650	19413	20750
	140	16463	17663	18650	19500	20275	21600
	150	16875	18100	19450	20388	21100	22438
	160	17338	18600	20225	21225	21900	23300
	180	–	19588	21688	22900	23613	25225
	200	–	–	22825	24188	25088	26875
	220	–	–	–	–	26738	28638
2 Veneer variant 1	120	19838	20025	20125	20750	21075	21588
	130	20613	21200	21588	22225	22575	23175
	140	20850	21413	21800	22463	22788	23413
	150	21175	21538	22163	22713	23050	23800
	160	22200	22813	23688	24325	24688	25363
	180	–	23338	24600	25350	25713	26475
	200	–	–	25350	26188	26713	27613
	220	–	–	–	–	27900	28875
2 Veneer variant 2	120	20900	21125	21400	22075	22463	23063
	130	21850	22450	23063	23800	24213	24838
	140	22175	22713	23350	24100	24538	25300
	150	22600	22963	23725	24438	24838	25825
	160	23638	24250	25363	26138	26550	27488
	180	–	24775	26250	27400	27850	28775
	200	–	–	27013	28275	28875	29938
	220	–	–	–	–	30050	31188

– not available *available from table depth 60 cm



Square/rectangular



466/00

Connecting leaf, stackable
to extend models 465/00, 465/11 and 465/51

SEK

Additional charge/reduced prices

Bullnose (double) lipping all the way round with impact-resilient profile **per running meter**

Chamfered lipping on the long sides* for veneer variant 1 **per running meter**

Chamfered lipping on the long sides* for veneer variant 2 **per running meter**

588

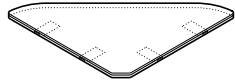
800

975

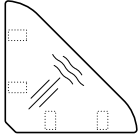
Table top group

	Width	Depth					
		45	60	70	75	80	90
1 Laminate variant 1	60	–	9088	–	–	–	–
	70	–	–	9288	–	–	–
	75	–	–	–	9600	–	–
	80	–	–	–	–	10050	–
	90	–	–	–	–	–	10825
	120	9350	10188	10900	11525	11988	12863
	140	9638	10500	11463	12150	12638	13538
	160	–	–	12013	12825	13275	14213
1 Laminate variant 2	60	–	11063	–	–	–	–
	70	–	–	11963	–	–	–
	75	–	–	–	12775	–	–
	80	–	–	–	–	13025	–
	90	–	–	–	–	–	14550
	120	10875	12525	13863	14800	15338	16763
	140	11425	13025	14513	15500	16100	17525
	160	–	–	15175	16175	16863	18275
2 Veneer variant 1	60	–	15263	–	–	–	–
	70	–	–	15438	–	–	–
	75	–	–	–	15888	–	–
	80	–	–	–	–	16175	–
	90	–	–	–	–	–	16650
	120	15300	16750	17338	17913	18175	18788
	140	15813	17275	17988	18575	18900	19538
	160	–	–	18638	19275	19650	20325
2 Veneer variant 2	60	–	15950	–	–	–	–
	70	–	–	16213	–	–	–
	75	–	–	–	16700	–	–
	80	–	–	–	–	16975	–
	90	–	–	–	–	–	17313
	120	16475	17913	18625	19313	19688	20263
	140	17125	18550	19488	20213	20588	21338
	160	–	–	20325	21100	21513	22450

– not available



Corner element 90°



466/10

Connecting leaf, stackable
to extend models 465/00 and 465/11

SEK

Additional charge/reduced prices

Bullnose (double) lipping all the way round with impact-resilient profile **per running meter**

588

Table top group

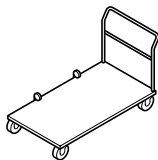
	Width	Depth				
		60	70	75	80	90
1 Laminate variant 1	95	11813	–	–	–	–
	109	–	12013	–	–	–
	116	–	–	12325	–	–
	123	–	–	–	12775	–
	137	–	–	–	–	13550
1 Laminate variant 2	95	13788	–	–	–	–
	109	–	14688	–	–	–
	116	–	–	15500	–	–
	123	–	–	–	15750	–
	137	–	–	–	–	17275
2 Veneer variant 1	95	17988	–	–	–	–
	109	–	18163	–	–	–
	116	–	–	18613	–	–
	123	–	–	–	18900	–
	137	–	–	–	–	19375
2 Veneer variant 2	95	18675	–	–	–	–
	109	–	18938	–	–	–
	116	–	–	19425	–	–
	123	–	–	–	19700	–
	137	–	–	–	–	20038

– not available



SEK

Four-wheeled trolley

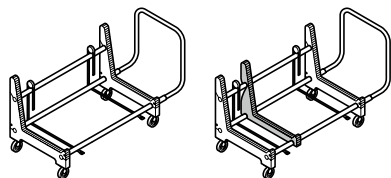


468/1

Basic
80 x 150, H 100
for 8 folding tables or 5 folding tables with 4 connecting leaves with maximum table top length of 160 cm
Felt-covered base
secured with straps

12038

Four-wheeled trolley



468/2

Comfort
85 x 190, H 100
for 6 folding tables or 4 folding tables with 3 connecting leaves with maximum table top length of 140 - 220 cm
Load-bearing areas with edge protection
secured with straps

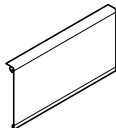
21875

Additional charge/reduced prices

Additional load-bearing area, can be shifted for smaller square, rectangular and round table tops

5013

Modesty panel



469

H40, black fabric, can be rolled up
Black-coated guide bar*

Table top width

Modesty panel width

60	58	3125
70	68	3225
75	73	3263
80	78	3300
90	88	3413
120	118	3613
130	128	3688
140	138	3813
150	148	3888
160	158	4000
180	178	4138
200	198	4438
220	218	4825
Corner element 90°	12	2400

* available from 60 cm table depth

Not available in combination with chamfered lipping or table-table connectors

Cable outlet

707/1

Black plastic, Ø 80 mm

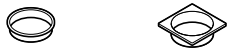
575



Integrated techni-station Compact set consisting of:

SEK

Round or square installation frame compact



Multimedia



Storage mesh



Integrated Techni-station Compact set 701/95 with port, cable outlet chrome matte, with a brushed profile

1263

Integrated techni-station Compact set 701/95 with wireless charging port:

4063

1 x slot with wireless charging module (5 watt, Qi compliant) with supply lead approx. 180 cm and power adapter

Integrated techni-station Compact set 701/95 with power supply module:

2025

1 x power supply module (when ordering please state the local standard) with 40 cm supply lead, mod. 708/8
2 x slots with cover for optional Keystone modules

Integrated techni-station Compact set 701/95 with power supply module and USB port

3800

1 x power supply module (when ordering please state the local standard) with 40 cm supply lead, mod. 708/8
1 x USB port with Smart IC (charging current 2A max.)
1 x slot with cover for optional Keystone modules

Additional charge/reduced prices

Keystone module, HDMI jack as a thru-type coupling, without cables

350

Keystone module RJ 45 connector (category 6) as a thru-type coupling, without cables

188

708/8 supply lead

Length approx. 200 cm
Length approx. 300 cm
Length approx. 500 cm

275
325
450



Cable harness covered with black textile sleeving

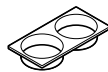
1725



Integrated techni-station Compact Duo set consisting of:

SEK

Rectangular installation frame compact duo



Multimedia



Storage mesh



Set Integrated techni-station Compact Duo 701/96 with slot for cable outlet chrome matte, with surface with brushed strip/brushed profile

1000

Integrated techni-station Compact Duo set 701/96 with wireless charging slot*:

3813

1 x slot with wireless charging module (5 watt, Qi compliant) with supply lead approx. 180 cm and power supply unit

Integrated techni-station Compact Duo set 701/96 with power supply module*:

1713

1 x power supply module (when ordering please state the local standard) with 40 cm supply lead, mod. 708/8
2 x slots with cover for optional Keystone modules

Integrated techni-station Compact Duo set 701/96 with power supply module and USB port*:

3500

1 x power supply module (when ordering please state the local standard) with 40 cm supply lead, mod. 708/8
1 x USB port with Smart IC (charging current 2A max.)
1 x slot with cover for optional Keystone modules

Additional charge/reduced prices

Keystone module RJ 45 jack (category 6) as a thru-type coupling, without cables

188

Keystone module, HDMI jack as a thru-type coupling, without cables

350

708/8 supply lead

Length approx. 200 cm
Length approx. 300 cm
Length approx. 500 cm

275
325
450



Cable harness covered with black textile sleeving

1725





SEK

Techni-station Compact Add:



Techni-station Compact Add 701/97 with power supply module:

3238

1 x power supply module (when ordering please state the local standard) with approx. 270 cm supply lead
2 x slots with cover for optional Keystone modules

Additional charge/reduced prices

Keystone module RJ 45 connector (category 6) with permanently attached lead, approx. length 330 cm 1188

Keystone module, HDMI jack with permanently attached lead, approx. length 270 cm 1188

Cable harness covered with black textile sleeving 1725



Can be used on straight and bullnose lipping, but not with modesty panels.

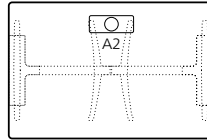


- Integrated techni-station compact duo
- Integrated techni-station compact or cable outlet

A maximum of two built-in component sets are to be integrated per table. Possible positions: Either A 1 and A 3 or A 2.

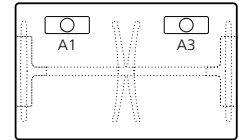
Table top width 120 – 140 cm

465/00



120 cm

465/00

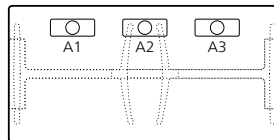


130 – 140 cm

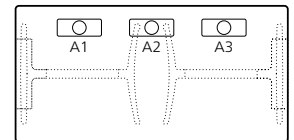
Set	Mounting position	Table top width 120 – 140 cm			Table top width 130 – 140 cm		
		A1	A2	A3	A1	A2	A3
Integrated techni-station compact 701/95		–	•	–	•	–	•
Integrated techni-station compact duo 701/96		–	•	–	•	–	•
Cable outlet 707/1		–	•	–	•	–	•

Table top width from 150 cm

460/00



465/00



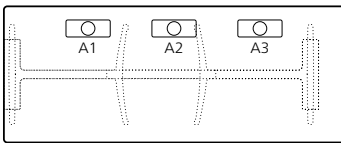
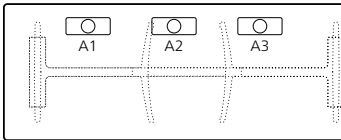
Set	Mounting position	Table top width from 150 cm			Table top width from 150 cm		
		A1	A2	A3	A1	A2	A3
Integrated techni-station compact 701/95		•	• ¹	•	•	• ¹	•
Integrated techni-station compact duo 701/96		•	• ²	•	•	• ²	•
Cable outlet 707/1		•	• ¹	•	•	• ¹	•

¹ from 160 cm table width
² from table width 180 cm
³ from table width 200 cm

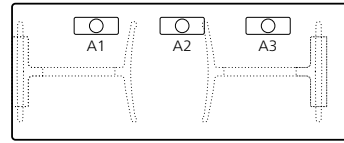
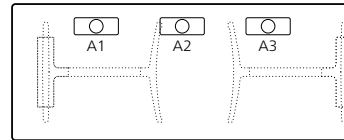
• available
– not available



460/11
460/21

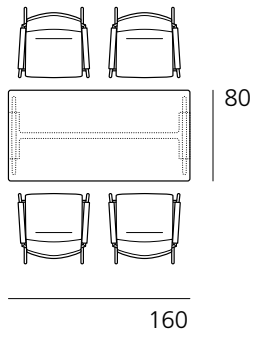


465/11
465/21

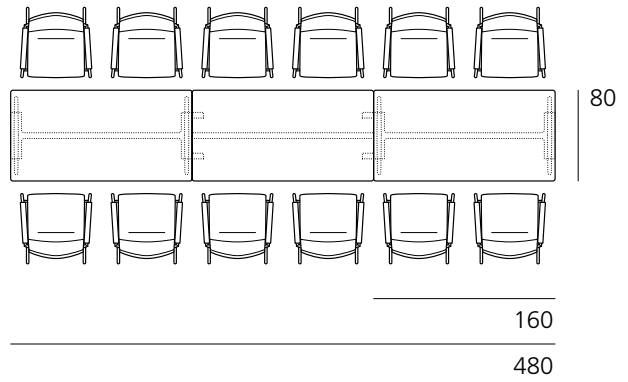


A1	A2	A3
•	• ³	•
•	• ³	•
•	• ³	•

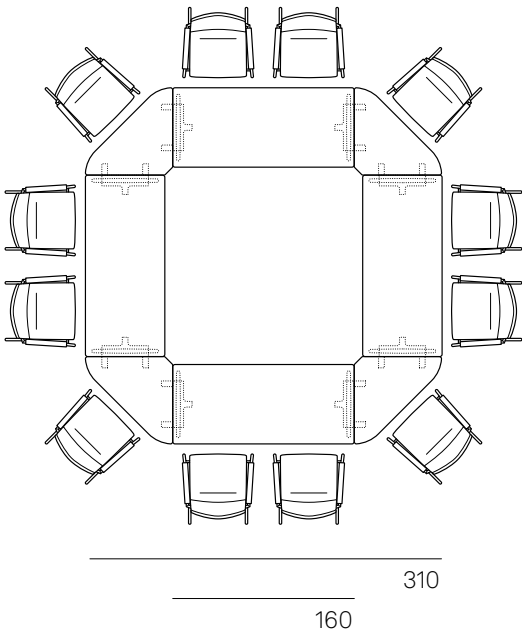
A1	A2	A3
•	• ³	•
•	• ³	•
•	• ³	•



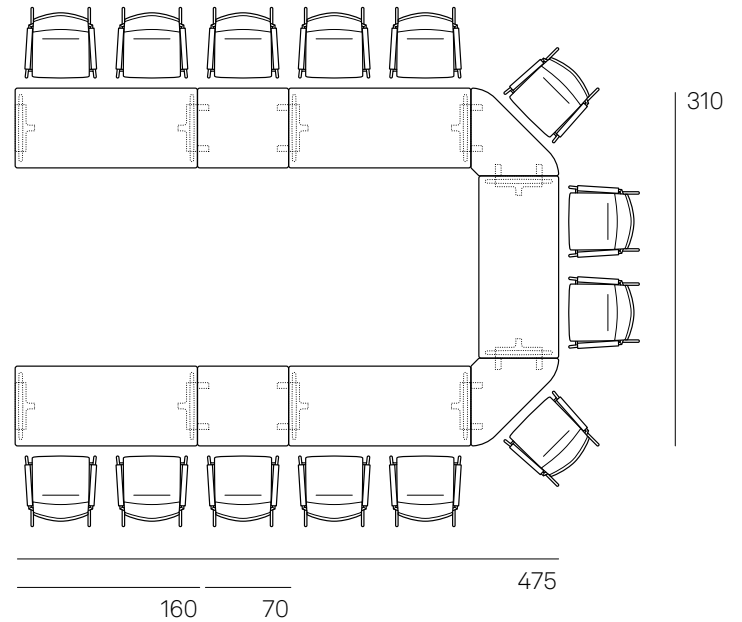
4 People
460/00 or 465/00



12 People
2 x 460/00 or 465/00
1 x 461/00 or 466/00



12 People
4 x 460/00 or 465/00, 160x70
4 x 461/10 or 466/10, 109x70/70, 90°



14 People
5 x 460/00 or 465/00, 160x70
2 x 461/00 or 466/00, 70x70
2 x 461/10 or 466/10, 109x70/70, 90°



610 Range Timetable

Design: Andreas Störiko



Technical details

Function

Mobile table range with flip-top table tops and feet that turn in automatically in the process. For multi-use spaces designed for interactive and dynamic conference types in settings where people convene for meetings, workshops, projects, training courses and talks. When horizontal, the table top locks automatically and two pull rods fitted underneath release it to flip it up. The feet that turn in allow the tables to nest into one another very compactly and without staggered nesting at the sides. Ideal in combination with items from the Confair 440 range.

Frame

Foot section in die-cast aluminum, bright chrome-plated or polished. Uprights and underframes in tubular steel, coated in black or with a silver satin finish. Upright optionally available with bright chrome plating. Table top bearer in die-cast zinc, coated black, lockable, height adjustable, swivel casters with a black polyamide tire are the standard version for carpets; casters available with a polyurethane tire for hard floors (please specify when ordering). Models as of a 750 mm table depth have a bigger foot section and shorter uprights.

Core material of table top

Plywood with bullnose or straight wood edging all the way round and with an integrated impact-resilient profile made of black elastomer or with straight plastic edging all the way round.

Table top group 1 – laminate

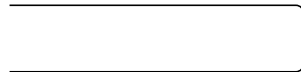
Table top thickness 26 mm

Variant 1

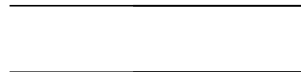
Laminate (single color) based on Wilkhahn's color and surface samples with wood edging, natural oiled finish or color-matched plastic edging.



Standard type: Bullnose with impact-resilient profile

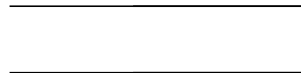


Straight edging with an impact-resilient profile



Straight plastic edging

Wood decor laminate from the Wilkhahn color and surface samples with color-matched plastic edging.



Straight plastic edging

Tables	Foot section	Upright and underframes	Supports
48	Coated white (RAL 9016)	Coated white	Coated white
51	Bright chrome-plated	Coated black, black with a textured matte finish, white, white with a textured matte finish, or with a silver satin finish, or bright chrome plating	Coated black
52	Polished aluminum	Coated black, black with a textured matte finish, white, white with a textured matte finish, or with a silver satin finish, or bright chrome plating	Coated black
53	Coated black (RAL 9011)	Coated black	Coated black
90	Coated with a black textured matte finish (RAL 9011)	Coated with a black textured matte finish (RAL 9011)	Coated with a black textured matte finish (RAL 9011)
91	Coated white with a textured matte finish (RAL 9016)	Coated white with a textured matte finish (RAL 9016)	Coated white with a textured matte finish (RAL 9016)

Awards



reddot award
winner



Variant 2

Soft matte laminate from the Wilkhahn color and surface samples with wood edging in natural oiled finish or color-matched with the plastic edging. Anti-reflective, soft-touch surface with anti-fingerprint characteristics.



Standard type: Bullnose with impact-resilient profile



Straight edging with an impact-resilient profile



Straight plastic edging

Table top group 2 – veneer

Table top thickness 26 mm



Standard type: Bullnose with impact-resilient profile



Straight edging with an impact-resilient profile

Variant 1

Beech, oak or ash veneer (exception: natural ash with chamfered edging not possible) from the Wilkhahn woodstain color samples with wood edging, color-matched as far as possible with the veneer.

Variant 2

Maple (exception: no maple with a natural finish with chamfered edging), walnut or elm veneer from the Wilkhahn woodstain color samples with wood edging, color-matched as far as possible with the veneer.

Veneer type

As a standard, the veneers are made by slip-match method. Surfaces sealed with clear lacquer: open-pore: Oak, ash, walnut and elm veneer closed-pore: Maple and beech veneer. Some specific growth features possible.

Standards

The Timetable tables comply with the ANSI/BIFMA X5.5 standard.

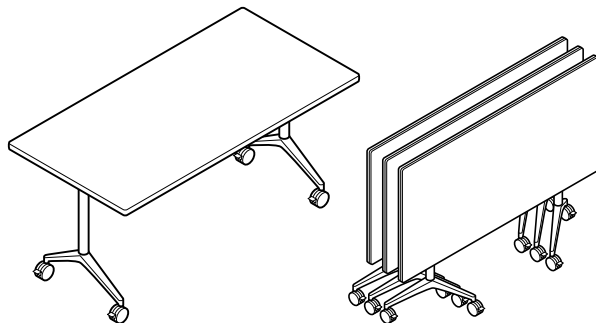
When placing repeat orders, please indicate whether your table tops have slip-matched or book-matched veneer.

Modesty panels (underneath the table)

Aluminum frame, coated with a silver satin finish, in anthracite or covered with black fabric. Black polyamide handles.

Table-table connectors (optional)

Metal table-table connectors Model 613: two lockable circlips made of black coated sheet steel with four star-grip screws and additionally for Timetable Smart: table-table connectors in plastic. Model 616: two rotatable circlips and two collets made of black through-dyed fiberglass-reinforced polyamide with washers.



Rectangular



610/00

75 x 150, H 73 nest into one another
Polished aluminum foot section, aluminum-coated uprights and underframes

SEK

Additional charge/reduced prices

Bright chrome-plated aluminum foot section, aluminum-coated uprights and underframes 1050
Bright chrome-plated aluminum foot section and upright, coated aluminum underframes 1750

Plastic lipping all the way round for laminate variant 1 (single color) and 2 **per running meter** -275

Aluminum coated modesty panel (length 140 cm) 10313
Coated aluminum modesty panel (length 150 cm) 10413
Coated aluminum modesty panel (length 160 cm) 10525
Coated aluminum modesty panel (length 180 cm) 10688

Table-table-connectors model 613, metal (2 items) 950

Table top group

	Width	Depth			
		60	70	75	80
1 Laminate variant 1	140	24675	25825	27063	27638
	150	25600	27038	27975	28338
	160	26538	27925	28525	28900
	180	27450	28675	29375	29850
1 Laminate variant 2	140	26663	28175	29625	30375
	150	27750	29613	30750	31288
	160	28863	30700	31488	32038
	180	30075	31763	32713	33400
2 Veneer variant 1	140	27475	29225	30963	32063
	150	28888	31263	32863	33375
	160	30250	32700	33738	34175
	180	31588	33775	34975	35738
2 Veneer variant 2	140	31038	33250	35425	37025
	150	32925	35788	38150	38663
	160	34788	37825	38825	39738
	180	36588	39163	40400	41700

SEK

Cable outlet



707/1

Black plastic, Ø 80 mm

575

All tables have casters for soft flooring (e. g. carpets). Please order with soft casters (at no extra charge) for hard flooring (e. g. stone, parquet)



612 Range

Timetable Smart

Design: Andreas Störiko



Technical details

Function

Mobile table range with flip-top table tops, which lock automatically in a horizontal and vertical position. The models are a good choice for multi-use spaces designed for interactive and dynamic conference types in settings where people convene for meetings, workshops, projects, training courses and talks. Can also accommodate complex multi-media requirements thanks to its particularly robust design and the fact that the table tops can be flipped up and locked in a vertical position. As a result, it's ideal for multipurpose areas and temporary workspaces. A horizontal pull rod underneath the table top flips it up. The integrated storage buffer allows staggered nesting of the tables at the sides. Ideal in combination with items from the Confair 440 range.

Frame

Foot section in die-cast aluminum, bright chrome-plated or polished. Uprights and underframes in tubular steel, coated in black or with a silver satin finish. Table top bearer in steel profile, draw rod in round steel tubing, coated black. Lockable, height adjustable, swivel casters with a black polyamide tire are the standard version for carpeted floors; casters available with a polyurethane tire for hard floors (please specify when ordering).

Models as of a 750 mm table depth have a bigger foot section and shorter uprights.

Core material of table top

Plywood with a bonded melamine resin surface with straight, color-matched plastic edging all the way round or optionally with plywood with bullnose or straight wood edging all the way round and with an integrated impact-resilient profile made of black elastomer or with straight plastic edging all the way round.

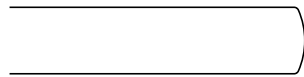
Table top group 1 – laminate

Table top thickness 26 mm

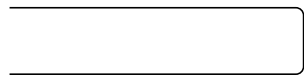
Variant 1

Laminate (single color) from the Wilkhahn color and surface samples with wood lipping, with a natural oiled finish or color-matched plastic lipping. Wood decor laminate from the Wilkhahn color and surface samples with color-matched plastic lipping.

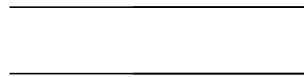
Laminate (single color) from Wilkhahn's color and surface samples with wood edging, natural oiled finish or color-matched plastic edging.



Standard type: Bullnose with impact-resilient profile

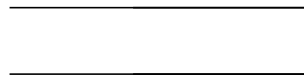


Straight edging with an impact-resilient profile



Straight plastic edging

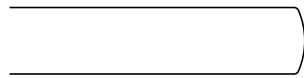
Wood decor laminate from the Wilkhahn color and surface samples with color-matched plastic edging.



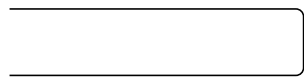
Straight plastic edging

Variant 2

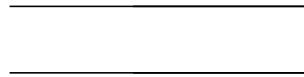
Soft matte laminate from the Wilkhahn color and surface samples with wood edging, natural oiled finish or color-matched plastic edging. Antireflective, anti-fingerprint soft touch surface.



Standard type: Bullnose with impact-resilient profile



Straight edging with an impact-resilient profile



Straight plastic edging

Tables	Foot section	Upright and underframes	Supports
48	Coated white (RAL9016)	Coated white	Coated white
51	Bright chrome-plated	Coated black, black with a textured matte finish, white, white with a textured matte finish, or with a silver satin finish, or bright chrome plating	Coated black
52	Polished aluminum	Coated black, black with a textured matte finish, white, white with a textured matte finish, or with a silver satin finish, or bright chrome plating	Coated black
53	Coated black (RAL9011)	Coated black	Coated black
90	Coated with a black textured matte finish (RAL9011)	Coated with a black textured matte finish (RAL9011)	Coated with a black textured matte finish (RAL9011)
91	Coated white with a textured matte finish (RAL9016)	Coated white with a textured matte finish (RAL9016)	Coated white with a textured matte finish (RAL9016)



Table top group 2 – veneer

Table top thickness 26 mm



Standard type: Bullnose with impact-resilient profile



Straight edging with an impact-resilient profile

Variant 1

Beech, oak or ash veneer (exception: natural ash with chamfered edging not possible) from the Wilkhahn woodstain color samples with wood edging, color-matched as far as possible with the veneer.

Variant 2

Maple (exception: no maple with a natural finish with chamfered edging), walnut or elm veneer from the Wilkhahn woodstain color samples with wood edging, color-matched as far as possible with the veneer.

Veneer type

As a standard, the veneers are made by slip-match method. Surfaces sealed with clear lacquer: open-pore: Oak, ash, walnut and elm veneer closed-pore: Maple and beech veneer. Some specific growth features possible.

Standards

The Timetable tables comply with the ANSI/BIFMA X5.5 standard.

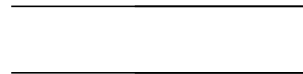
When placing repeat orders, please indicate whether your table tops have slip-matched or book-matched veneer.

Table top group 5 – bonded surface

Table top thickness 25 mm

Bonded melamine resin surface in white, light or dark gray with plastic edging to colour-match the finish.

Further finishes for the formats shown in the price list are available on request.



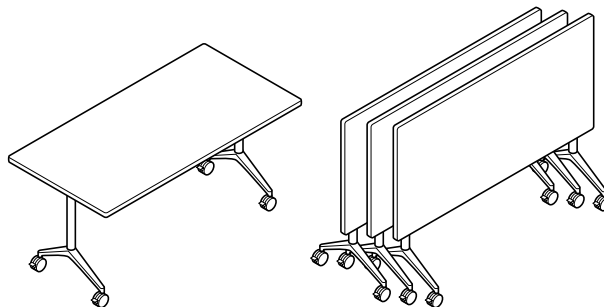
Straight plastic edging

Modesty panels (underneath the table)

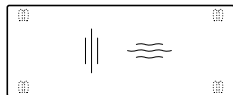
Aluminum frame, coated with a silver satin finish, in anthracite or covered with black fabric. Black polyamide handles.

Table-table connectors (optional)

Metal table-table connectors Model 613: two lockable circlips made of black coated sheet steel with four star-grip screws and additionally for Timetable Smart: table-table connectors in plastic. Model 616: two rota-table circlips and two collets made of black through-dyed fiberglass-reinforced polyamide with washers.



Rectangular



612/00

e.g. 75 x 150, H 73, nest into one another
Polished aluminum foot section, aluminum-coated uprights and underframes

SEK

Additional charge/reduced prices

Bright chrome-plated aluminum foot section, aluminum-coated uprights and underframes

1088

Plastic lipping all the way round for laminate variant 1 (single color) and 2 **per running meter**

-275

Table-table-connectors model 613, metal (2 items)

950

Table-table-connectors model 616, plastic (2 items)

950

Table top group

	Width	Depth			
		60	70	75	80
5 Direct coating	120	13188	-	-	-
	140	-	14175	-	-
	150	14150	-	14213	-
	160	-	-	-	14438
1 Laminate variant 1	120	21763	-	-	-
	140	-	22950	-	-
	150	22913	-	23163	-
	160	-	-	-	23563
1 Laminate variant 2	120	24350	-	-	-
	140	-	26338	-	-
	150	26075	-	26975	-
	160	-	-	-	27475
2 Veneer variant 1	120	26638	-	-	-
	140	-	27800	-	-
	150	27663	-	27938	-
	160	-	-	-	28450
2 Veneer variant 2	120	31800	-	-	-
	140	-	33113	-	-
	150	33025	-	33388	-
	160	-	-	-	34338

SEK

Cable outlet



707/1

Black plastic, Ø 80 mm

575

- not available

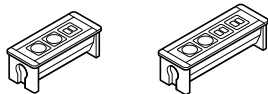
All tables have casters for soft flooring (e.g. carpets). Please order with soft casters (at no additional charge) for hard flooring (e.g. stone, parquet)



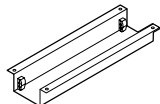


Integrated techni-station Rotate set for A2 mounting position consisting of:

Integrated techni-station rotate 701/60 or 701/70



Cable cover for techni-station



Cable holder under the table top with hook and loop strap



Cable clip for the table legs (2)



Integrated techni-station Rotate set 701/60 with 3 modules:

9775

2 x power supply modules (please state local standard when ordering) with supply lead, approx. 300 cm in length
1 x data module with 2 x RJ45 jacks (category 6, shielded) with permanently attached cables, approx. 350 cm in length or optionally with USB charger type A + type C with Smart IC and PD 2.0 to recharge up to two mobile devices.

Set Integrated Techni-Station Rotate 701/70 with 4 modules:

15450

2 x power supply modules (when ordering please state the local standard) with supply lead approx. 300 cm long
1 x data module with 2 x RJ45 connectors (category 6, shielded) with cables approx. 350 cm long permanently attached
1 x slot with VGA connector (15 pin D-sub) + 3.5 mm stereo jack or optionally HDMI connector with permanently attached cables, length approx. 300 cm

Additional charge/reduced prices

Techni-station with mechanism that opens by pressing the top

1250

Cable harness covered with black textile sleeving

1725



Integrated techni-station Compact set consisting of:

SEK

Round or square installation frame compact



Multimedia



Cable holder under the table top with hook and loop strap



Cable clip for the table legs (2)



Set integrated techni-station Compact 701/95 with slot for cable outlet chrome matte and surface with brushed strip/brushed profile

2288

Integrated techni-station Compact set 701/95 with wireless charging slot:

5113

1 x slot with wireless charging module (5 watt, Qi compliant) with supply lead approx. 180 cm and power supply unit

Integrated techni-station Compact set 701/95 with power supply module:

3038

1 x power supply module (when ordering please state the local standard) with 40 cm supply lead, mod. 708/8
2 x slots with cover for optional Keystone modules

Integrated techni-station Compact set 701/95 with power supply module and USB port

4875

1 x power supply module (when ordering please state the local standard) with 40 cm supply lead, mod. 708/8
1 x USB port with Smart IC (charging current 2A max.)
1 x slot with cover for optional Keystone modules

Additional charge/reduced prices

Keystone module, HDMI jack as a thru-type coupling, without cables

350

Keystone module RJ 45 connector (category 6) as a thru-type coupling, without cables

188

708/8 supply lead

Length approx. 200 cm

275

Length approx. 300 cm

325

Length approx. 500 cm

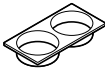






450

Cable harness covered with black textile sleeving


1725






Integrated techni-station Compact Duo set consisting of:	SEK	Cable outlet set consisting of:	SEK
Rectangular installation frame compact duo 		Cable outlet 707/1 	
Multimedia 			
Cable holder under the table top with hook and loop strap 		Cable holder under the table top with hook and loop strap 	
Cable clip for the table legs (2) 		Cable clip for the table legs (2) 	
Set Integrated techni-station Compact Duo 701/96 with slot for cable outlet chrome matte, with surface with brushed strip/brushed profile	1550	Cable outlet set 707/1 Black plastic, Ø 80 mm	1988
Integrated techni-station Compact Duo set 701/96 with wireless charging slot*:	4338		
1 x slot with wireless charging module (5 watt, Qi compliant) with supply lead approx. 180 cm and power supply unit			
Integrated techni-station Compact Duo set 701/96 with power supply module*:	2275		
1 x power supply module (when ordering please state the local standard) with 40 cm supply lead, mod. 708/8 2 x slots with cover for optional Keystone modules			
Integrated techni-station Compact Duo set 701/96 with power supply module and USB port*:	4088		
1 x power supply module (when ordering please state the local standard) with 40 cm supply lead, mod. 708/8 1 x USB port with Smart IC (charging current 2A max.) 1 x slot with cover for optional Keystone modules			

Additional charge/reduced prices

Keystone module RJ 45 jack (category 6) as a thru-type coupling, without cables	188
Keystone module, HDMI jack as a thru-type coupling, without cables	350
708/8 supply lead	
Length approx. 200 cm	275
Length approx. 300 cm	325
Length approx. 500 cm	450
Cable harness covered with black textile sleeving	1725
	

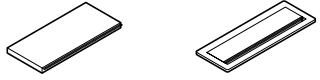
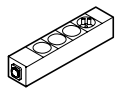
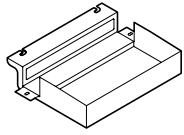
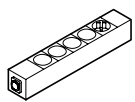


Additional charge/reduced prices

Cable harness covered with black textile sleeving	1725
	

* The price is for one module. Add the prices of two modules to obtain the price for a set.

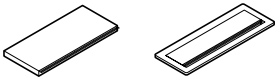
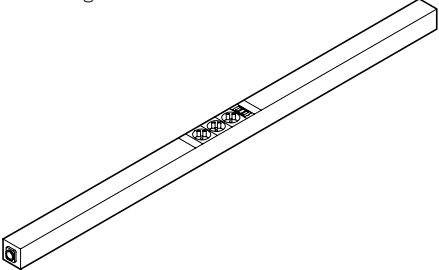



All prices include section cut out of table
Further details from page 194
For individual cable outlets see accessories page 141



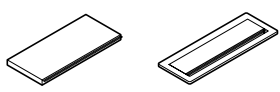
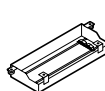
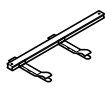

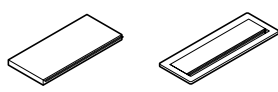



Single table portal set for Power Bar consisting of:	SEK	Socket strips Power Bar	SEK
<p>Cable lid Executive or Basic</p> 		<p>Mod. 704/00 Power Bar with 4 modules</p> <p>Body optionally in black or white, with an input/output for Neutrik-powerCON® cable 1 x power supply module (when ordering please state local standard) 3 x configurable blank section</p> 	2000
<p>Cable channel for Power Bar mod. 704/00 and 705/00 optionally in black (RAL 9017) or white (RAL 9010)</p> 		<p>Mod. 705/00 Power Bar with 5 modules</p> <p>Body optionally in black or white, with an input/output for Neutrik-powerCON® cable 1 x power supply module (when ordering please state local standard) 4 x configurable blank section</p> 	2138
<p>Cable management underneath the table top with hook and loop strap on the right and left</p> 		<p>Ports for blank sections</p> <p>Please note: Power and charging fields must be configured directly after one another</p>	
<p>Cable lid Executive set 150 x 300 mm</p> <p>Table top group 1, laminate variant 1 and 2</p> <p>Table top group 2, veneer variant 1 and 2</p>	16338 19913	<p>Power supply module (when ordering, state local standard)</p>	275
<p>Basic cable lid set 120 x 300 mm</p> <p>including fastening material for Power Bar socket strip, please order Power Bar separately</p>	6363	<p>Dual USB-A charging, 1/2 module</p> <p>Dual USB-C and USB-A charging, 1/2 module</p> <p>USB-C power charging 60W, module</p> <p>USB 3.0-data, Keystone module, 1/2 module</p> <p>USB-C data (1/2 module) with approx. 30 cm cable</p> <p>RJ45 network, CAT 6, Keystone module, 1/2 module</p> <p>Twin network RJ45, CAT 6, Keystone module, module</p> <p>HDMI, Keystone module, 1/2 module</p> <p>Blanking plate, 1/2 module</p> <p>Blanking plate, module</p>	1675 3100 4963 563 850 288 475 1100 38 50
<p>Additional charge/reduced prices</p> <p>Bumper for bottom of the cable channel with black sponge rubber (for mod. 610)</p> <p>Cable clip for the table legs (2)</p> 	250 14	<p>Kabel</p> <p>702/8 Neutrik-powerCON® supply lead</p> <p>Length approx. 200 cm</p> <p>Length approx. 300 cm</p> <p>Length approx. 500 cm</p> <p>702/9 Extension lead Neutrik-powerCON®</p> <p>Length approx. 80 cm</p> <p>Length approx. 100 cm</p> <p>Length approx. 150 cm</p> <p>Length approx. 200 cm</p> <p>Patch cable CAT6, length approx. 200 cm</p> <p>Patch cable CAT6, length approx. 300 cm</p> <p>USB 3.0 data cable, length approx. 300 cm</p> <p>USB type C data, connecting cable, length approx. 300 cm</p> <p>HDMI cable, length approx. 300 cm</p>	600 713 1100 925 1038 1225 1400 225 263 288 400 338

Timetable
Built-in component sets

For mod. 614/00 M2 mounting position M2, single table portal set for Power Bar for positioning over the underframe, consisting of:

	SEK	Socket strips Power Bar	SEK
Cable lid Executive or Basic 		Mod. 704/10 Power Bar with 4 modules Body optionally in black or white, with an input/output for Neutrik-powerCON® cable 1 x power supply module (when ordering please state local standard) 3 x configurable blank section 	3425
Underframe prepared for Power Bar Mod. 704/10			
Cable lid Executive set 150 x 300 mm Table top group 1, laminate variant 1 and 2 Table top group 2, veneer variant 1 and 2	11963 15500		
Basic cable lid set 120 x 300 mm including fastening material for Power Bar socket strip, please order Power Bar separately	7613	Ports for blank sections Please note: Power and charging fields must be configured directly after one another Power supply module (when ordering, state local standard) Dual USB-A charging, 1/2 module Dual USB-C and USB-A charging, 1/2 module USB-C power charging 60W, module Blanking plate, 1/2 module Blanking plate, module	275 1675 3100 4963 38 50
Additional charge/reduced prices Cable clip for the table legs (2) 	14	Kabel 702/8 Neutrik-powerCON® supply lead  Length approx. 200 cm Length approx. 300 cm Length approx. 500 cm 702/9 Extension lead Neutrik-powerCON®  Length approx. 80 cm Length approx. 100 cm Length approx. 150 cm Length approx. 200 cm	600 713 1100 925 1038 1225 1400



Cable lid set with cable channel consisting of:	SEK	For mod. 614/00 M2 mounting position; cable lid set for positioning over the underframe consisting of:	SEK
<p>Cable lid Executive or Basic</p>  <p>Cable channel to integrate the socket strip.</p>  <p>Cable holder under the table top with hook and loop strap</p>  <p>Cable clip for the table legs (2)</p> 		<p>Cable lid Executive or Basic</p>  <p>Strain relief 614/8</p>  <p>Cable holder 614/9</p>  <p>Cable clip for the table legs (2)</p> 	
<p>Executive cable lid set 150 x 300 mm</p> <p>Table top group 1, laminate variant 1 and 2</p> <p>Table top group 2, veneer variant 1 and 2 incl. fastening material for socket strip, please order the socket strip separately, vertical fitting possible Can be combined with modesty panel on request</p>	<p>18063</p> <p>21700</p>	<p>Executive cable lid set 150 x 300 mm</p> <p>Table top group 1, laminate variant 1 and 2</p> <p>Table top group 2, veneer variant 1 and 2 incl. fastening material for socket strip, please order socket strip separately, can be fitted horizontally</p>	<p>12638</p> <p>16363</p>
<p>Basic cable lid set 120 x 300 mm</p> <p>incl. fastening material for socket strip, please order the socket strip separately, vertical fitting possible Can be combined with modesty panel on request</p>	<p>8113</p>	<p>Basic cable lid set 120 x 300 mm</p> <p>incl. fastening material for socket strip, please order socket strip separately, can be fitted horizontally</p>	<p>2338</p>

Additional charge/reduced prices

Cable harness covered with black textile sleeving



1725

Additional charge/reduced prices

Cable harness covered with black textile sleeving








1725



Socket strips for cable lid set

SEK

<p>Mod. 708/1 socket strip with 3 modules</p> <p>3 x power supply modules (when ordering state local standard) please order supply/connecting lead separately</p> 	788
<p>Mod. 708/2 socket strip with 3 modules:</p> <p>2 x power supply modules (when ordering please state the local standard) Please order supply-/connecting cable separately 1 x data module with 2 x RJ45 connectors (category 6, shielded) with patch cables permanently connected, approx. 350 cm long or optionally with 1 x slot with 2 x USB ports (charging current 2.1A) to recharge up to two mobile devices</p> 	3688
<p>Mod. 708/4 socket strip with 4 modules:</p> <p>4 x power supply modules (please state local standard when ordering) Please order supply/connecting lead separately</p> 	925
<p>Mod. 708/5 socket strip with 4 modules:</p> <p>2 x power supply modules (when ordering please state the local standard) please order supply/connecting cable separately 1 x data module with 2 x RJ45 jacks (category 6, shielded) with permanent patch cables approx. 350 cm long permanently attached 1 x VGA jack (15 pin D-sub) + 3.5 mm stereo jack or optionally HDMI jack with permanently attached cables, length approx. 300 cm</p> 	9388
<p>Mod. 708/6 socket strip with 5 modules:</p> <p>3 x power supply modules (state local standard when ordering) Please order power supply/connecting cable separately 1 x data module with 2 x RJ45 connectors (category 6 shielded) 1 x data module with 1 x RJ45 jack (category 6 shielded) with permanently attached patch cables approx. 350 cm long</p> 	5575

Additional charge/reduced prices

708/8 supply lead



Length approx. 200 cm
 Length approx. 300 cm
 Length approx. 500 cm

275
 325
 450

708/9 extension lead



Length approx. 200 cm
 Length approx. 300 cm

250
 313

Timetable
Mounting positions

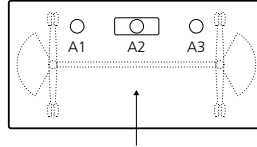


- Integrated techni-station Basic, on both sides, cable lids, integrated techni-station Compact Duo or Power Bar
- Integrated techni-station compact or cable outlet

A maximum of two built-in component sets are to be integrated per table. Possible positions: Either A/M 1 and A/M 3 or A/M 2.

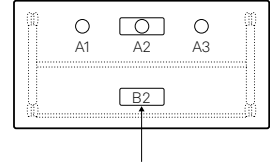
Timetable

610/00



Timetable Smart

612/00



Set	Mounting position	A 1	A 2	A 3	A 1	A 2	A 3	B 2
Integrated techni-station rotate	701/60 701/70	–	•	–	–	•	–	–
Cable lid Executive Basic		–	• ¹	–	–	–	–	–
Integrated techni-station compact	701/95	•	•	•	•	•	•	–
Integrated techni-station compact duo	701/96	–	•	–	–	•	–	–
Cable outlet set	707/1	•	•	•	•	•	•	–
Integrated techni-station Basic, on both sides, cable lids or Power Bar		–	• ¹	–	–	–	–	• ²

¹ from table depth 75 cm

² for table size 75 x 150 cm and 80 x 160 cm

• available

– not available

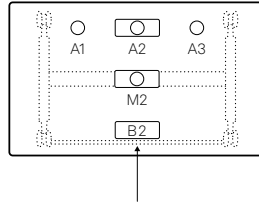


- Integrated techni-station basic, rotate or cable lids
- Integrated techni-station compact or cable outlet

A maximum of two built-in component sets are to be integrated per table. Possible positions: Either A/M 1 and A/M 3 or A/M 2.

Timetable Shift

614/00



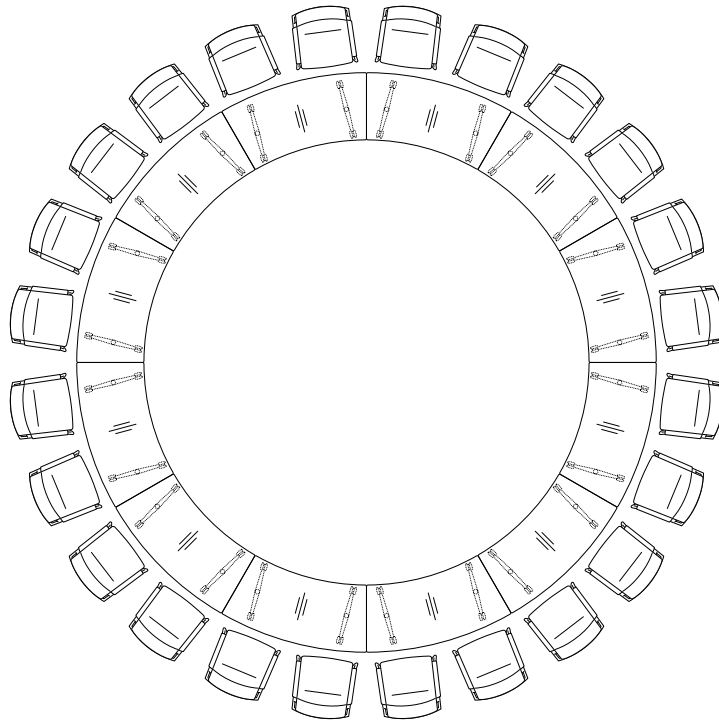
Set	Mounting position	A 1	A 2	A 3	B 2	M 2
Integrated techni-station rotate	701/60 701/70	–	•	–	–	–
Cable lid Executive Basic		–	• ¹	–	–	•
Integrated techni-station compact	701/95	•	•	•	–	•
Integrated techni-station compact duo	701/96	–	•	–	–	•
Cable outlet set	707/1	•	•	•	–	•
Power Bar					•	•

¹ from table depth 100 cm

• available
– not available

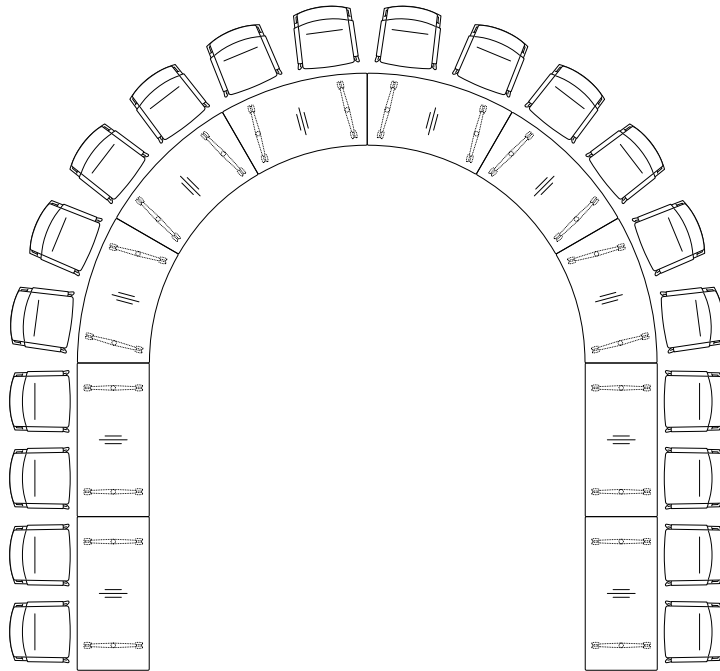


624



24 People,
Timetable
12 x Special element
120/161x80

632

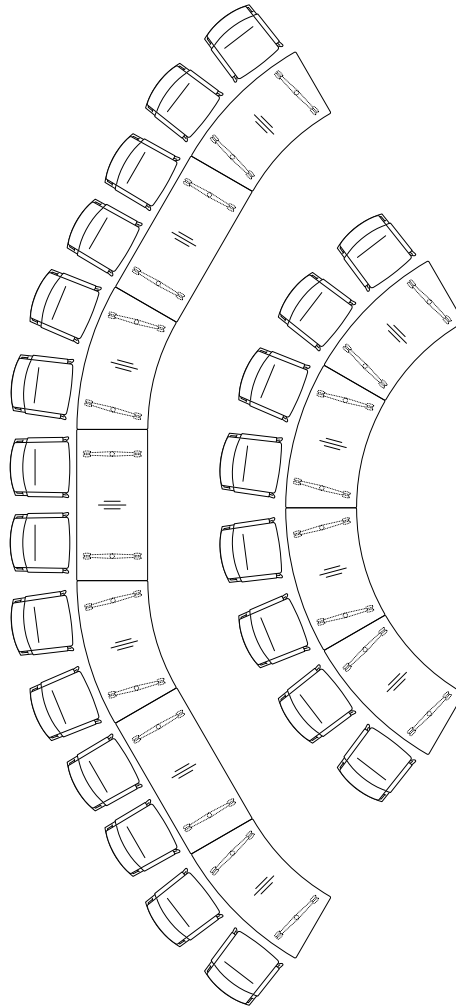


20 People,
Timetable
6 x Special element 120/161x80
4 x 610/00, 160x80

624

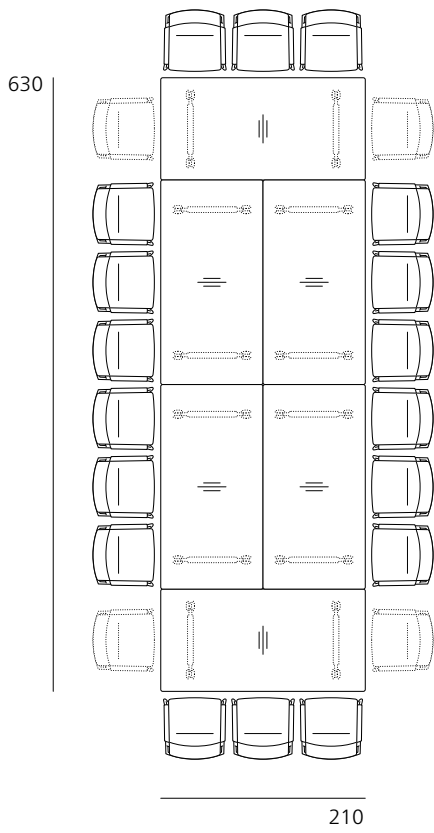


977

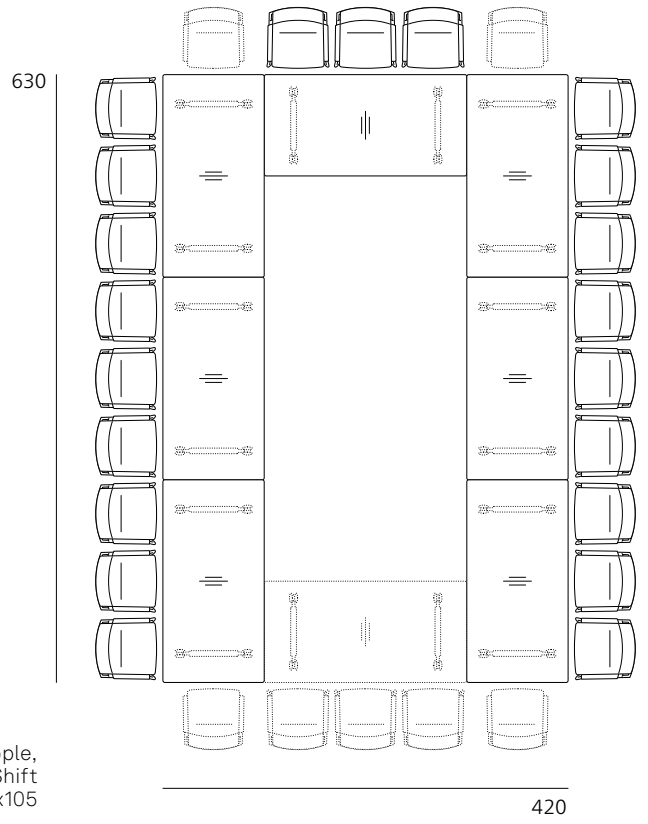


420

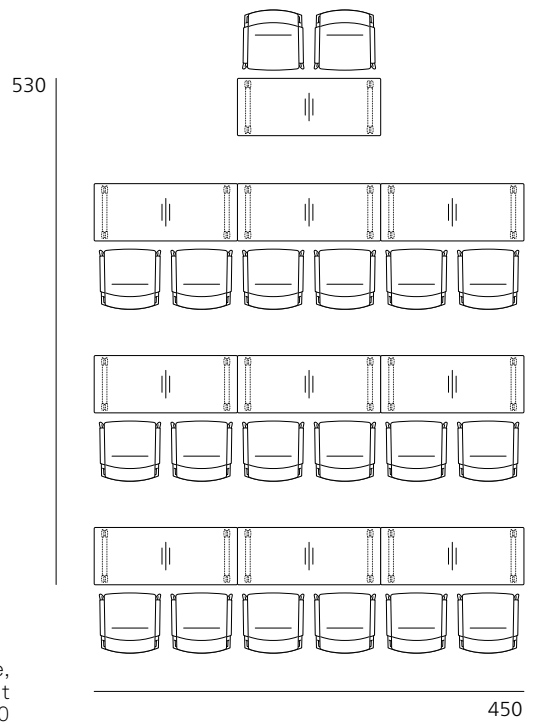
22 People,
Timetable
8 x Special element 120/161 x 80
3 x 610/00, 160x80



18 (22) People,
Timetable Shift
6 x 614/00, 210x105



21 (28) People,
Timetable Shift
7 (8) x 614/00, 210x105



20 People,
Timetable Smart
10 x 612/51, 150x60



614 Range Timetable Shift

Design: Andreas Störiko



Technical details

Function

Mobile table range with flip-top table tops, which lock automatically in a horizontal and vertical position. With an underframe connector, designed as a spacious cable channel, the models are a sound choice for multi-use spaces designed for interactive and dynamic conference types in settings where people convene for meetings, workshops and projects. The sturdy design and vertical locking mechanism mean it is suitable for multipurpose spaces, temporary workspaces and where power solutions need to be fitted in the middle. A horizontal pull rod underneath the table top flips it up. The integrated storage buffers allow compact staggered nesting of the tables at the sides. Because the frame is virtually identical, it's perfect in combination with fold-up tables from the Confair 440 range and table systems from the Logon 620 range and further items from the Confair 440 range.

Frame

Die-cast aluminum foot section, bright chrome-plated, polished or with a silver satin finish or black coating. Aluminum profile upright, clear anodized or silver satin finish, or black coating; in bright chrome-plated foot sections, coated in black. Upright optionally available with bright chrome plating. Aluminum profile underframe, with integrated cable channel, coated in silver satin finish or black depending on the foot section. Steel profile table top bearer. Round steel tubing draw rod, black or with a silver satin finish coating depending on the foot section. Lockable, height-adjustable polyamide swivel casters.

Core material of table top

Plywood with bullnose or straight wood edging all the way round and with an integrated impact-resilient profile made of black elastomer or with straight plastic edging all the way round.

Table top group 1 – laminate

Table top thickness 26 mm

Variant 1

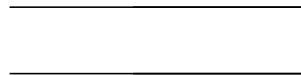
Laminate (single color) based on Wilkhahn's color and surface samples with wood edging, natural oiled finish or color-matched plastic edging.



Standard type: bullnose with impact-resilient profile

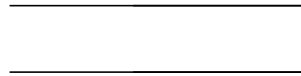


Alternatively: Straight edging with an impact-resilient profile



Straight plastic edging

Wood decor laminate from the Wilkhahn color and surface samples with color-matched plastic edging.



Straight plastic edging

Tables	Foot section	Upright	Underframes	Supports
48	Coated white (RAL9016)	Coated white	to match the color of the upright	Coated white
51	Bright chrome-plated	Silver satin finish, coated black or black with textured matte finish or with bright chrome plating	to match the color of the upright	Coated black
52	Polished aluminum	Clear anodized aluminum	Clear anodized aluminum	Silver satin finish, coated black or black with textured matte finish
53	Coated black (RAL9011)	Coated black	to match the color of the upright	Coated black
60	Coated with a silver satin finish (RAL9006)	Coated with a silver satin finish	to match the color of the upright	Coated with a silver satin finish
90	Coated with a black textured matte finish (RAL9011)	Coated with a black textured matte finish (RAL9011)	to match the color of the upright	Coated with a black textured matte finish (RAL9011)
91	Coated white with a textured matte finish (RAL9016)	Coated white with a textured matte finish (RAL9016)	to match the color of the upright	Coated white with a textured matte finish (RAL9016)



Variant 2

Soft matte laminate from the Wilkhahn color and surface samples with wood edging in natural oiled finish or color-matched with the plastic edging. Antireflective, antifingerprint soft touch surface.



Standard type: Bullnose with impact-resilient profile



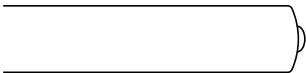
Alternatively: Straight edging with an impact-resilient profile



Straight plastic edging

Table top group 2 – veneer

Table top thickness 26 mm



Standard type: Bullnose with impact-resilient profile



Alternatively: Straight edging with impact-resilient profile

Variant 1

Beech, oak or ash veneer (exception: natural ash with chamfered edging not possible) from the Wilkhahn woodstain color samples with wood edging, color-matched as far as possible with the veneer.

Variant 2

Maple (exception: no maple with a natural finish with chamfered edging), walnut or elm veneer from the Wilkhahn woodstain color samples with wood edging, color-matched as far as possible with the veneer.

Veneer type

As a standard, the veneers are made by slip-match method. Surfaces sealed with clear lacquer: open-pore: Oak, ash, walnut and elm veneer closed-pore: Maple and beech veneer. Some specific growth features possible.

Standards

The Timetable tables comply with the DIN EN 15372 and ANSI/BIFMA X5.5 standard.



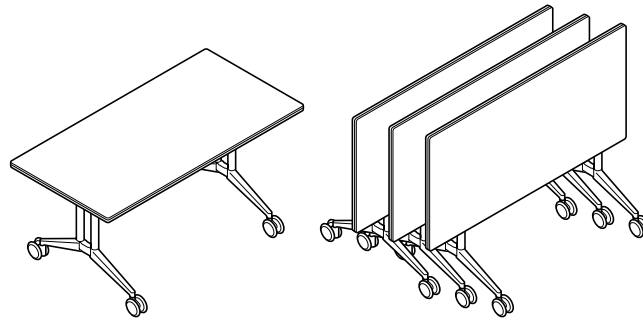
When placing repeat orders, please indicate whether your table tops have slip-matched or book-matched veneer.

Modesty panels (underneath the table)

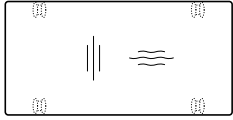
Aluminum frame, coated with a silver satin finish, in anthracite or covered with black fabric. Black polyamide handles.

Table-table connectors (optional)

Metal table-table connectors Model 613: two lockable circlips made of black coated sheet steel with four star-grip screws and additionally for Timetable Smart: table-table connectors in plastic.



Rectangular



614/00

e. g. 90 x 180, H 73, nest into one another
Coated aluminum foot section, coated uprights and underframes

SEK

Additional charge/reduced prices

Polished aluminum foot section, clear anodized uprights, coated underframes	1450
Bright chrome-plated aluminum foot section, uprights and underframes coated	2975
Bright chrome-plated aluminum foot section, bright chrome-plated uprights, underframes coated	6600
Plastic lipping all the way round for laminate variant 1 (single color) and 2 per running meter	-275
Coated aluminum modesty panel (length 150 cm)	11300
Coated aluminum modesty panel (length 160 cm)	11425
Coated aluminum modesty panel (length 180 cm)	11600
Coated aluminum modesty panel (length 200 cm)	11825
Coated aluminum modesty panel (length 210 cm)	14138
Table-table-connectors model 613, metal (2 items)	950

Table top group

	Width	Depth			
		80	90	100	105
1 Laminate variant 1	150	22413	23263	-	-
	160	23263	24925	27025	-
	180	25188	26488	30863	32675
	200	28463	30325	34700	35900
	210	31363	33175	38138	39550
1 Laminate variant 2	150	25475	26738	-	-
	160	26738	28700	31238	-
	180	28950	30750	35700	37775
	200	32725	35163	40200	41663
	210	35900	38363	43938	45688
2 Veneer variant 1	150	26188	27438	-	-
	160	27438	30000	32263	-
	180	30363	31513	36750	38425
	200	33850	35925	41275	43613
	210	37188	39038	44750	46425
2 Veneer variant 2	150	31375	32025	-	-
	160	32025	35600	37675	-
	180	36300	36900	42750	44438
	200	39200	41900	47863	50338
	210	43500	45188	51300	53288

SEK

Cable outlet



707/1

Black plastic, Ø 80 mm

575

- not available

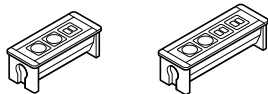
All tables have casters for soft flooring (e. g. carpets). Please order with soft casters (at no extra charge) for hard flooring (e. g. stone, parquet)



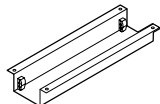


Integrated techni-station Rotate set for A2 mounting position consisting of:

Integrated techni-station rotate 701/60 or 701/70



Cable cover for techni-station



Cable holder under the table top with hook and loop strap



Cable clip for the table legs (2)



Integrated techni-station Rotate set 701/60 with 3 modules:

9775

2 x power supply modules (please state local standard when ordering) with supply lead, approx. 300 cm in length
1 x data module with 2 x RJ45 jacks (category 6, shielded) with permanently attached cables, approx. 350 cm in length or optionally with USB charger type A + type C with Smart IC and PD 2.0 to recharge up to two mobile devices.

Set Integrated Techni-Station Rotate 701/70 with 4 modules:

15450

2 x power supply modules (when ordering please state the local standard) with supply lead approx. 300 cm long
1 x data module with 2 x RJ45 connectors (category 6, shielded) with cables approx. 350 cm long permanently attached
1 x slot with VGA connector (15 pin D-sub) + 3.5 mm stereo jack or optionally HDMI connector with permanently attached cables, length approx. 300 cm

Additional charge/reduced prices

Techni-station with mechanism that opens by pressing the top

1250

Cable harness covered with black textile sleeving

1725



Integrated techni-station Compact set consisting of:

SEK

Round or square installation frame compact



Multimedia



Cable holder under the table top with hook and loop strap



Cable clip for the table legs (2)



Set integrated techni-station Compact 701/95 with slot for cable outlet chrome matte and surface with brushed strip/brushed profile

2288

Integrated techni-station Compact set 701/95 with wireless charging slot:

5113

1 x slot with wireless charging module (5 watt, Qi compliant) with supply lead approx. 180 cm and power supply unit

Integrated techni-station Compact set 701/95 with power supply module:

3038

1 x power supply module (when ordering please state the local standard) with 40 cm supply lead, mod. 708/8
2 x slots with cover for optional Keystone modules

Integrated techni-station Compact set 701/95 with power supply module and USB port

4875

1 x power supply module (when ordering please state the local standard) with 40 cm supply lead, mod. 708/8
1 x USB port with Smart IC (charging current 2A max.)
1 x slot with cover for optional Keystone modules

Additional charge/reduced prices

Keystone module, HDMI jack as a thru-type coupling, without cables

350

Keystone module RJ 45 connector (category 6) as a thru-type coupling, without cables

188

708/8 supply lead

Length approx. 200 cm

275

Length approx. 300 cm

325

Length approx. 500 cm

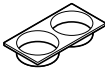


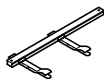
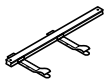


450

Cable harness covered with black textile sleeving


1725






Integrated techni-station Compact Duo set consisting of:	SEK	Cable outlet set consisting of:	SEK
Rectangular installation frame compact duo 		Cable outlet 707/1 	
Multimedia 			
Cable holder under the table top with hook and loop strap 		Cable holder under the table top with hook and loop strap 	
Cable clip for the table legs (2) 		Cable clip for the table legs (2) 	
Set Integrated techni-station Compact Duo 701/96 with slot for cable outlet chrome matte, with surface with brushed strip/brushed profile	1550	Cable outlet set 707/1 Black plastic, Ø 80 mm	1988
Integrated techni-station Compact Duo set 701/96 with wireless charging slot*:	4338		
1 x slot with wireless charging module (5 watt, Qi compliant) with supply lead approx. 180 cm and power supply unit			
Integrated techni-station Compact Duo set 701/96 with power supply module*:	2275		
1 x power supply module (when ordering please state the local standard) with 40 cm supply lead, mod. 708/8 2 x slots with cover for optional Keystone modules			
Integrated techni-station Compact Duo set 701/96 with power supply module and USB port*:	4088		
1 x power supply module (when ordering please state the local standard) with 40 cm supply lead, mod. 708/8 1 x USB port with Smart IC (charging current 2A max.) 1 x slot with cover for optional Keystone modules			

Additional charge/reduced prices

Keystone module RJ 45 jack (category 6) as a thru-type coupling, without cables	188
Keystone module, HDMI jack as a thru-type coupling, without cables	350
708/8 supply lead	
Length approx. 200 cm	275
Length approx. 300 cm	325
Length approx. 500 cm	450
Cable harness covered with black textile sleeving	1725
	

Additional charge/reduced prices

Cable harness covered with black textile sleeving	1725
	

* The price is for one module. Add the prices of two modules to obtain the price for a set.

All prices include section cut out of table
Further details from page 194
For individual cable outlets see accessories page 141



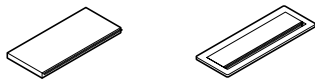
Single table portal set for Power Bar consisting of:

SEK

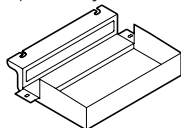
Socket strips Power Bar

SEK

Cable lid Executive or Basic



Cable channel for Power Bar mod. 704/00 and 705/00
optionally in black (RAL 9017) or white (RAL 9010)



Cable management underneath the table top with hook and loop strap on the right and left



Cable lid Executive set 150 x 300 mm

Table top group 1, laminate variant 1 and 2

16338

Table top group 2, veneer variant 1 and 2

19913

Basic cable lid set 120 x 300 mm

including fastening material for Power Bar socket strip, please order Power Bar separately

6363

Additional charge/reduced prices

Bumper for bottom of the cable channel with black sponge rubber (for mod. 610)

250

Cable clip for the table legs (2)

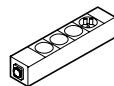
14



Mod. 704/00 Power Bar with 4 modules

2000

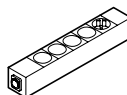
Body optionally in black or white, with an input/output for Neutrik-powerCON® cable
1 x power supply module (when ordering please state local standard)
3 x configurable blank section



Mod. 705/00 Power Bar with 5 modules

2138

Body optionally in black or white, with an input/output for Neutrik-powerCON® cable
1 x power supply module (when ordering please state local standard)
4 x configurable blank section



Ports for blank sections

Please note: Power and charging fields must be configured directly after one another

Power supply module (when ordering, state local standard)

275

Dual USB-A charging, 1/2 module

1675

Dual USB-C and USB-A charging, 1/2 module

3100

USB-C power charging 60W, module

4963

USB 3.0-data, Keystone module, 1/2 module

563

USB-C data (1/2 module) with approx. 30 cm cable

850

RJ45 network, CAT 6, Keystone module, 1/2 module

288

Twin network RJ45, CAT 6, Keystone module, module

475

HDMI, Keystone module, 1/2 module

1100

Blanking plate, 1/2 module

38

Blanking plate, module

50

Kabel

702/8 Neutrik-powerCON® supply lead



Length approx. 200 cm

600

Length approx. 300 cm

713

Length approx. 500 cm

1100

702/9 Extension lead Neutrik-powerCON®



Length approx. 80 cm

925

Length approx. 100 cm

1038

Length approx. 150 cm

1225

Length approx. 200 cm

1400

Patch cable CAT6, length approx. 200 cm

225

Patch cable CAT6, length approx. 300 cm

263

USB 3.0 data cable, length approx. 300 cm

288

USB type C data, connecting cable, length approx. 300 cm

400

HDMI cable, length approx. 300 cm

338



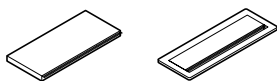
For mod. 614/00 M2 mounting position M2, single table portal set for Power Bar for positioning over the underframe, consisting of:

SEK

Socket strips Power Bar

SEK

Cable lid Executive or Basic



Underframe prepared for Power Bar Mod. 704/10

Cable lid Executive set 150 x 300 mm

Table top group 1, laminate variant 1 and 2

11963

Table top group 2, veneer variant 1 and 2

15500

Basic cable lid set 120 x 300 mm

including fastening material for Power Bar socket strip, please order Power Bar separately

7613

Additional charge/reduced prices

Cable clip for the table legs (2)

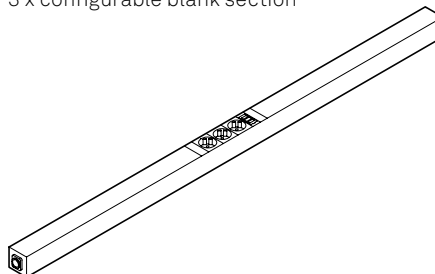


14

Mod. 704/10 Power Bar with 4 modules

3425

Body optionally in black or white, with an input/output for Neutrik-powerCON® cable
1 x power supply module (when ordering please state local standard)
3 x configurable blank section



Ports for blank sections

Please note: Power and charging fields must be configured directly after one another

Power supply module (when ordering, state local standard) 275

Dual USB-A charging, 1/2 module 1675

Dual USB-C and USB-A charging, 1/2 module 3100

USB-C power charging 60W, module 4963

Blanking plate, 1/2 module 38

Blanking plate, module 50

Kabel

702/8 Neutrik-powerCON® supply lead



Length approx. 200 cm 600

Length approx. 300 cm 713

Length approx. 500 cm 1100

702/9 Extension lead Neutrik-powerCON®



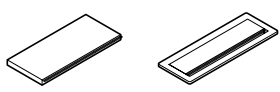
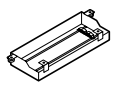
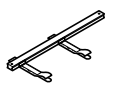

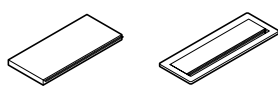



Length approx. 80 cm 925

Length approx. 100 cm 1038

Length approx. 150 cm 1225

Length approx. 200 cm 1400



Cable lid set with cable channel consisting of:	SEK	For mod. 614/00 M2 mounting position; cable lid set for positioning over the underframe consisting of:	SEK
<p>Cable lid Executive or Basic</p>  <p>Cable channel to integrate the socket strip.</p>  <p>Cable holder under the table top with hook and loop strap</p>  <p>Cable clip for the table legs (2)</p> 		<p>Cable lid Executive or Basic</p>  <p>Strain relief 614/8</p>  <p>Cable holder 614/9</p>  <p>Cable clip for the table legs (2)</p> 	
<p>Executive cable lid set 150 x 300 mm</p> <p>Table top group 1, laminate variant 1 and 2</p> <p>Table top group 2, veneer variant 1 and 2 incl. fastening material for socket strip, please order the socket strip separately, vertical fitting possible Can be combined with modesty panel on request</p>	<p>18063</p> <p>21700</p>	<p>Executive cable lid set 150 x 300 mm</p> <p>Table top group 1, laminate variant 1 and 2</p> <p>Table top group 2, veneer variant 1 and 2 incl. fastening material for socket strip, please order socket strip separately, can be fitted horizontally</p>	<p>12638</p> <p>16363</p>
<p>Basic cable lid set 120 x 300 mm</p> <p>incl. fastening material for socket strip, please order the socket strip separately, vertical fitting possible Can be combined with modesty panel on request</p>	<p>8113</p>	<p>Basic cable lid set 120 x 300 mm</p> <p>incl. fastening material for socket strip, please order socket strip separately, can be fitted horizontally</p>	<p>2338</p>

Additional charge/reduced prices

Cable harness covered with black textile sleeving



1725

Additional charge/reduced prices

Cable harness covered with black textile sleeving





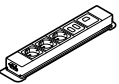


1725



Socket strips for cable lid set

SEK

<p>Mod. 708/1 socket strip with 3 modules</p> <p>3 x power supply modules (when ordering state local standard) please order supply/connecting lead separately</p> 	788
<p>Mod. 708/2 socket strip with 3 modules:</p> <p>2 x power supply modules (when ordering please state the local standard) Please order supply-/connecting cable separately 1 x data module with 2 x RJ45 connectors (category 6, shielded) with patch cables permanently connected, approx. 350 cm long or optionally with 1 x slot with 2 x USB ports (charging current 2.1A) to recharge up to two mobile devices</p> 	3688
<p>Mod. 708/4 socket strip with 4 modules:</p> <p>4 x power supply modules (please state local standard when ordering) Please order supply/connecting lead separately</p> 	925
<p>Mod. 708/5 socket strip with 4 modules:</p> <p>2 x power supply modules (when ordering please state the local standard) please order supply/connecting cable separately 1 x data module with 2 x RJ45 jacks (category 6, shielded) with permanent patch cables approx. 350 cm long permanently attached 1 x VGA jack (15 pin D-sub) + 3.5 mm stereo jack or optionally HDMI jack with permanently attached cables, length approx. 300 cm</p> 	9388
<p>Mod. 708/6 socket strip with 5 modules:</p> <p>3 x power supply modules (state local standard when ordering) Please order power supply/connecting cable separately 1 x data module with 2 x RJ45 connectors (category 6 shielded) 1 x data module with 1 x RJ45 jack (category 6 shielded) with permanently attached patch cables approx. 350 cm long</p> 	5575

Additional charge/reduced prices

708/8 supply lead



Length approx. 200 cm
Length approx. 300 cm
Length approx. 500 cm

275
325
450

708/9 extension lead



Length approx. 200 cm
Length approx. 300 cm

250
313

**Timetable
Mounting positions**



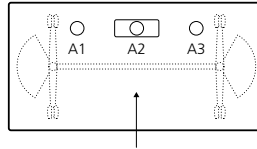
□ Integrated techni-station Basic, on both sides, cable lids, integrated techni-station Compact Duo or Power Bar

○ Integrated techni-station compact or cable outlet

A maximum of two built-in component sets are to be integrated per table. Possible positions: Either A/M 1 and A/M 3 or A/M 2.

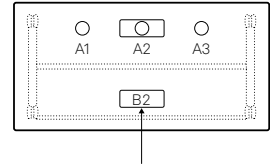
Timetable

610/00



Timetable Smart

612/00



Set	Mounting position	A 1	A 2	A 3	A 1	A 2	A 3	B 2
Integrated techni-station rotate	701/60 701/70	–	•	–	–	•	–	–
Cable lid Executive Basic		–	• ¹	–	–	–	–	–
Integrated techni-station compact	701/95	•	•	•	•	•	•	–
Integrated techni-station compact duo	701/96	–	•	–	–	•	–	–
Cable outlet set	707/1	•	•	•	•	•	•	–
Integrated techni-station Basic, on both sides, cable lids or Power Bar		–	• ¹	–	–	–	–	• ²

¹ from table depth 75 cm

² for table size 75 x 150 cm and 80 x 160 cm

• available

– not available

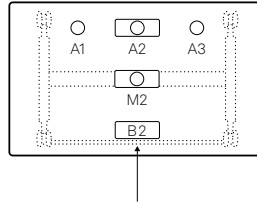


- Integrated techni-station basic, rotate or cable lids
- Integrated techni-station compact or cable outlet

A maximum of two built-in component sets are to be integrated per table. Possible positions: Either A/M 1 and A/M 3 or A/M 2.

Timetable Shift

614/00



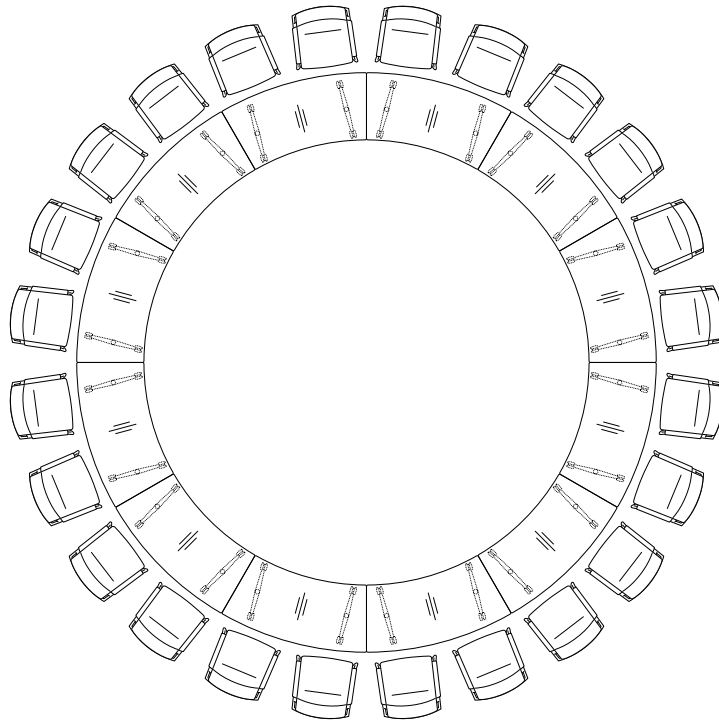
Set	Mounting position	A 1	A 2	A 3	B 2	M 2
Integrated techni-station rotate	701/60 701/70	–	•	–	–	–
Cable lid Executive Basic		–	• ¹	–	–	•
Integrated techni-station compact	701/95	•	•	•	–	•
Integrated techni-station compact duo	701/96	–	•	–	–	•
Cable outlet set	707/1	•	•	•	–	•
Power Bar					•	•

¹ from table depth 100 cm

• available
– not available

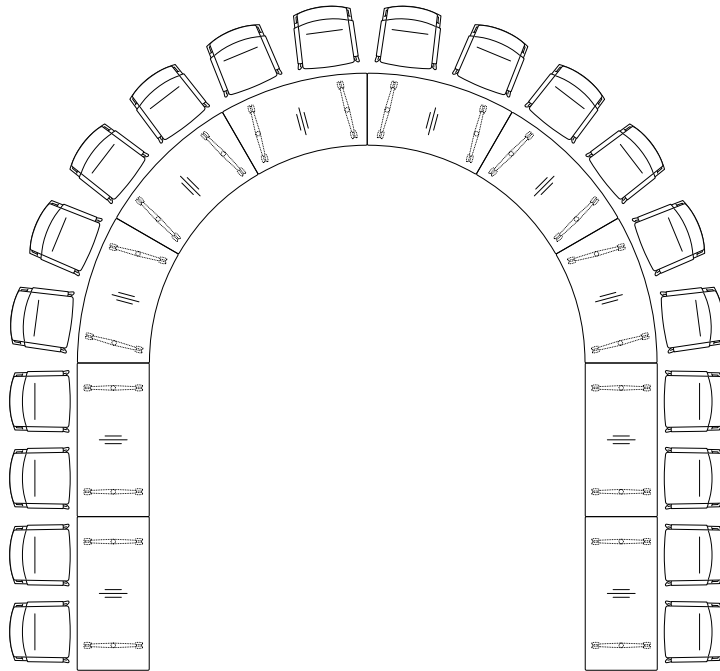


624



24 People,
Timetable
12 x Special element
120/161x80

632

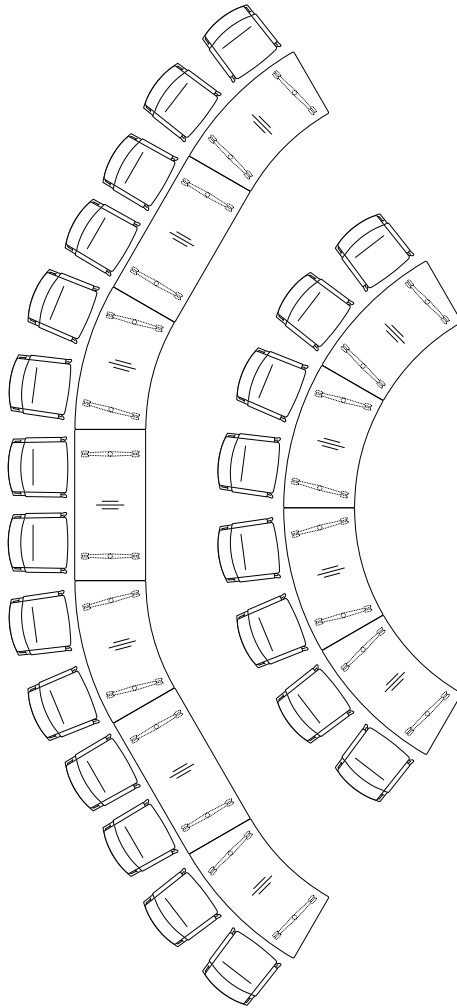


20 People,
Timetable
6 x Special element 120/161x80
4 x 610/00, 160x80

624

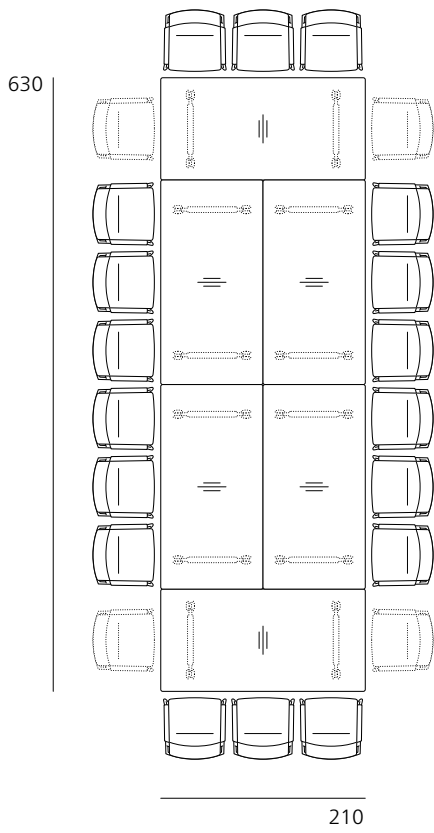


977

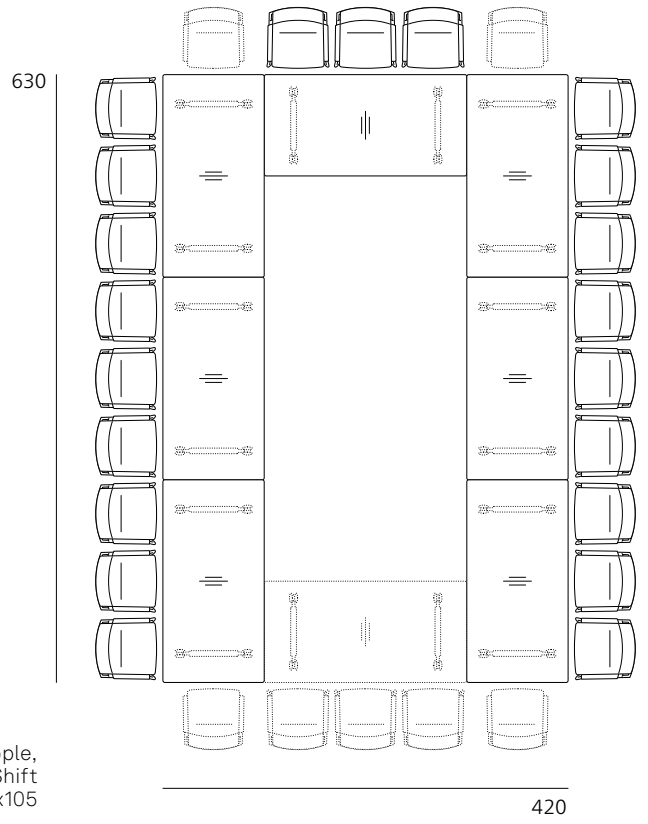


420

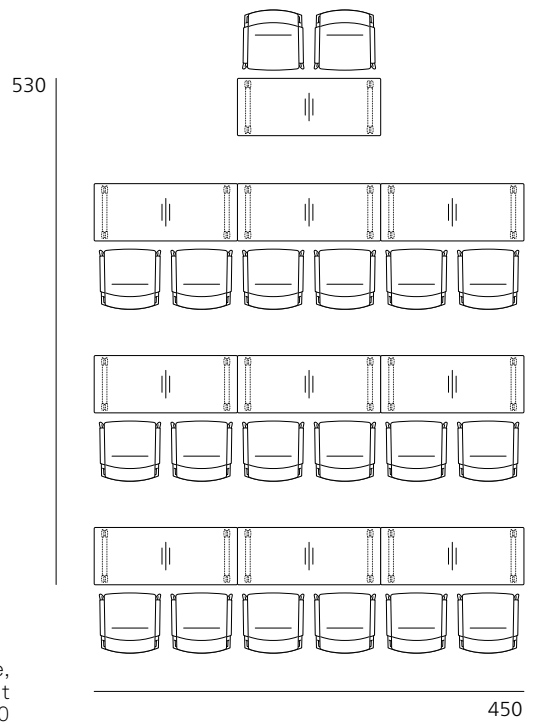
22 People,
Timetable
8 x Special element 120/161 x 80
3 x 610/00, 160x80



18 (22) People,
Timetable Shift
6 x 614/00, 210x105



21 (28) People,
Timetable Shift
7 (8) x 614/00, 210x105



20 People,
Timetable Smart
10 x 612/51, 150x60



615 Range Timetable Lift

Design: Andreas Störiko



Technical details

Function

Mobile table range whose height is electrically adjustable from 73-139 cm with flip-top table tops, optionally powered with a rechargeable battery.

The Timetable Lift is ideal when combined with the Timetable, Confair and Logon table ranges to enable multipurpose use of high-quality training, conference, presentation and meeting spaces. With a flip-top table top the Timetables nest compactly into one another.

Timetable Lift comes with a locking mechanism and staggered storage when they nest into one another.

With a surface that can be written on and is optionally magnetic, it can also be used as a whiteboard and projection screen.

Base frame

Aluminum foot section, bright chrome-plated, polished or with a silver satin finish or coated black. Electric telescopic column with an integrated sensor to stop items getting stuck in it. Uprights and crossways underframe in tubular steel, coated black or with a silver satin finish. Table top bearer in steel profile, draw rod in round steel tubing, coated black. Lockable, height-adjustable, swivel casters with a black polyamide tire are the standard version for carpets; casters available with a polyurethane tire for hard floors (please specify when ordering). The electronic control, including a three-meter supply lead and a cable and power cover, as well as the mount for the optional rechargeable battery are fitted underneath the table top. Cable and power cover retractable, made of black PET felt (at least 50% recycled). Tool-free fitting of the cover with knurled screws. Cover with cut-out sections for charge indicator on the optional rechargeable batteries.

Core material of table top

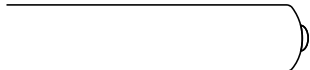
Plywood with bullnose (double) or straight wood edging all the way round with integrated impact-resilient profile made of black elastomer or with straight, plastic edging all the way round. Timetable Lift has an integrated button to adjust the height.

Table top group 1 – laminate

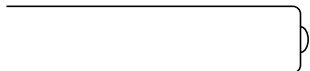
Table top thickness 26 mm

Variant 1

Laminate (single color) based on Wilkhahn's color and surface samples with wood edging, natural oiled finish.



Standard type: bullnose with impact-resilient profile



Alternatively: straight edge with impact-resilient profile

Wood decor laminate from the Wilkhahn color and surface samples with color-matched plastic edging.



Straight plastic edging

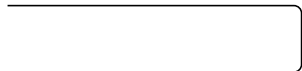
Variant 2

Soft matte laminate from the Wilkhahn color and surface samples with wood edging in a natural oiled finish or color-matched with the plastic edging.

Anti-reflective, soft-touch surface with anti-fingerprint characteristics.



Standard type: bullnose with impact-resilient profile



Alternatively: straight edge with impact-resilient profile



Straight plastic edging

Table top group 2 – veneer

Table top thickness 26 mm

Variant 1

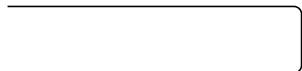
Beech, oak and ash veneer from Wilkhahn woodstain color samples with wood edging, as far as possible in the same colour as the veneer

Variant 2

Maple, walnut or elm veneer from the Wilkhahn woodstain color samples with wood edging, color-matched as far as possible with the veneer.



Standard type: bullnose with impact-resilient profile



Alternatively: straight edge with impact-resilient profile

Veneer type

As a standard, the veneers are made by slip-match method.

Surfaces sealed with clear lacquer:

open-pore: Oak, ash, walnut and elm veneer

closed-pore: maple and beech veneer.

Some specific growth features possible.

When placing repeat orders, please indicate whether your table tops have slip-matched or book-matched veneer.

Tables	Foot section	Upright and underframes	Supports
48	Coated white (RAL 9016)	Coated white	Coated black
51	Bright chrome-plated	Silver satin finish, coated black or black with textured matte finish	Coated black
52	Polished aluminum	Silver satin finish, coated black or black with textured matte finish	Coated black
53	Coated black (RAL 9011)	Coated black	Coated black
60	Coated with a silver satin finish (RAL 9006)	Coated with a silver satin finish	Coated with a silver satin finish



Table top with whiteboard

Table top thickness 26 mm white laminate with color-matched plastic edging. Table top can be written on with board marker pens, dry wiped and used as a projection screen, optionally magnetic.



Straight plastic edging

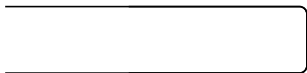


Straight edging with an impact-resilient profile

For the formats shown in the price list, other finishes are available on request.

Table top with whiteboard

Table top thickness 26 mm, very shiny white laminate with color-matched plastic edging. Table top can be written on with board marker pens, dry wiped and is magnetic. The very shiny surface causes more light reflection, so it's not suitable as a projection screen.



Straight plastic edging



Straight edging with an impact-resilient profile

For the formats shown in the price list, other finishes are available on request.

Table top group 5 – bonded surface

Table top thickness 25 mm

A bonded melamine resin surface with board functionality in white with color-matched, straight plastic edging, optionally with an impact-resilient profile. Table top can be written on with board marker pens, dry wiped and used as a projection screen.

Tilt function

Precision-adjustable tilt and locking of the table top via gas-pressure cylinder. Mechanism operated via the draw rod.

Monitor mount

Lightweight poplar plywood panel, 12 mm, 56 x 75 cm, covered on both sides with white laminate, with color-matched ABS edging. Underside with a large felt pad to protect the table top, as well as an extendable spacer for use with the optional wall mount.

Fastened by two steel C-clamps to the edge of the table top, which means it can be removed and shifted. Tool-free fitting with knurled screws.

Panel with Vesa standard mounting patterns 400 x 400 mm, 350 x 350 mm, 300 x 300 mm and 200 x 200 mm in various heights for central alignment of monitors. For monitors up to a maximum 60" screen diagonal, 76 mm depth and weighing 28 kg (stable in compliance with the DIN EN 1023-3:2001-01 standard). For monitors weighing more than 15 kg, we recommend the combination with a tilt function.

The monitor mount is retrofittable. The monitor and fastening material are not included.

Roll holder

Made of sheet steel, white with a textured matte finish and powder-coated, with a tear-off edge. Underside with a large felt pad to protect the table top and edge. Tool-free fitting with knurled screws, can be used horizontally and vertically. For holding rolls up to a maximum diameter of 7 cm and maximum length of 60 cm. Rolls available separately.

Vertical cable management

Cable riser for cable management on the table's standard upright, attached magnetically, length 139 cm, made of PA, optionally in black or white, through-dyed with a defined routing direction.

Cable holder

Cable holder made of plastic with a hook and loop strap to hold and route cables as desired. Magnetic or self-adhesive attachment to the table via the base. Optional attachment with two screws (included).

Whiteboard films

Roll with 25 sheets, 60 x 80 cm (W x H), perforated tear-off edge, electrostatic film, self-adhesive on almost any surface, can be removed without leaving residues. Whiteboard films in white, can be wiped.

Eco-friendly: Film is fully recyclable.

Flipchart films

Roll with 25 sheets, 60 x 80 cm (W x H), perforated tear-off edge, electrostatic film, self-adhesive on almost any surface, can be removed without leaving residues. Flipchart films with continuous grid, can't be wiped. Eco-friendly: Film is fully recyclable.

Paper roll

Paper roll 10 m, width 60 cm, pure white, grammage 120g/m².

Battery box

Compact and powerful lithium ion battery with 2.2 AH capacity, allowing the table to be raised about 40 times after being fully charged. With an LED charge indicator and acoustic signal to indicate that recharging is required. With retrofittable charger.

Standards

The Timetable Lift tables comply with the DIN EN 527 standard.

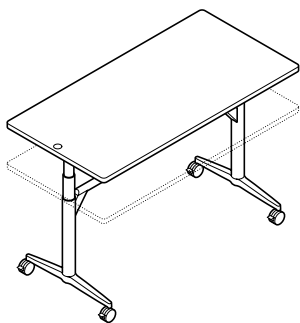


www.tuv.com
ID 1000000000





Rectangular



615/00

Electrically adjustable height (73 - 139 cm)
Coated aluminum foot section, uprights and underframes coated

Polished aluminum foot section, coated uprights and underframes

Additional charge/reduced prices

Polished aluminum foot section, coated uprights and underframes

Bright chrome-plated aluminum foot section, uprights and underframes coated

Plastic lipping all the way round for laminate variant 1 (single color) and 2 **per running meter**

Battery box: Lithium-ion battery with charger

Tilt function

SEK

1450

2975

-275

4250

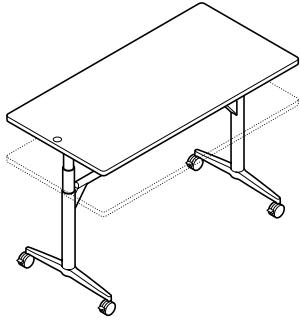
3388

Table top group

	Width	Depth			
		75	80	90	100
1 Laminate variant 1	150	36650	-	-	-
	160	-	37588	-	-
	180	-	-	41050	-
	200	-	-	-	49838
1 Laminate variant 2	150	39650	-	-	-
	160	-	41025	-	-
	180	-	-	45363	-
	200	-	-	-	54138
2 Veneer variant 1	150	40688	-	-	-
	160	-	42088	-	-
	180	-	-	46413	-
	200	-	-	-	56850
2 Veneer variant 2	150	46250	-	-	-
	160	-	46988	-	-
	180	-	-	52175	-
	200	-	-	-	63888



Rectangular



615/10

with board functionality
 electrically adjustable height (73 - 139 cm)
 White board, can be written on with board marker pens,
 can be used as a projection screen
 Coated aluminum foot section, coated uprights and underframes

SEK

Additional charge/reduced prices

Polished aluminum foot section, coated uprights and underframes	1450
Bright chrome-plated aluminum foot section, uprights and underframes coated	2975
Plastic edging all the way round with impact-resilient profile per running meter	350
Battery box: Lithium ion battery with charger	4250
Tilt function	3388

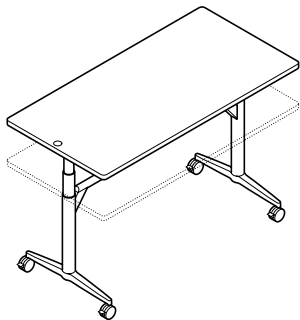
Table top group

	Width	Depth			
		75	80	90	100
1 Table top with whiteboard	150	33325 (58*)	-	-	-
	160	-	34163 (60*)	-	-
	180	-	-	37875 (70*)	-
	200	-	-	-	47263 (80*)
1 Table top doubles as a magnetic board	150	38900 (58*)	-	-	-
	160	-	40600 (60*)	-	-
	180	-	-	43563 (70*)	-
	200	-	-	-	51800 (80*)

* Possible project size diagonals (in inches)



Rectangular



615/11

with whiteboard functionality
 electrically adjustable height (73 - 139 cm)
 very shiny white laminate, can be written on with board marker pens
 Polished aluminum foot section, coated uprights and underframes

SEK

Additional charge/reduced prices

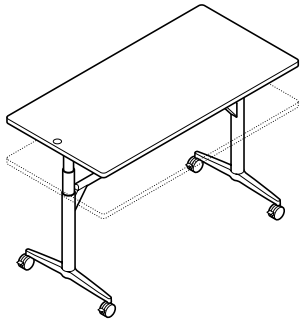
Polished aluminum foot section, coated uprights and underframes	1450
Bright chrome-plated aluminum foot section, uprights and underframes coated	2975
Plastic edging all the way round with impact-resilient profile per running meter	350
Battery box: Lithium-ion battery with charger	4250
Tilt function	3388

Table top group

	Width	Depth			
		75	80	90	100
1 Table top doubles as a magnetic board	150	42063	-	-	-
	160	-	43738	-	-
	180	-	-	48300	-
	200	-	-	-	56525



Rectangular



615/12

Electrically adjustable height (73 - 139 cm)
board with a white bonded surface,
can be written on with board marker pens,
can be used as a projection screen
Coated aluminum foot section, uprights and underframes coated

SEK

Additional charge/reduced prices

Polished aluminum foot section, coated uprights and underframes 1450
Bright chrome-plated aluminum foot section, uprights and underframes coated 2975

Battery box: Lithium-ion battery with charger 4250
Plastic edging all the way round with impact-resilient profile per running meter 350

Tilt function 3388

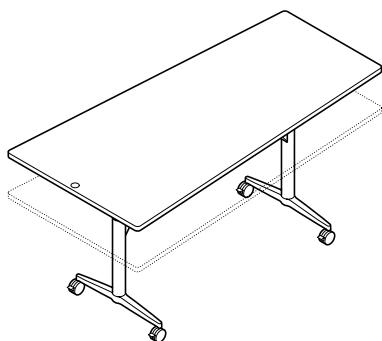
Table top group

	Width	Depth			
		75	80	90	100
5 Bonded surface with board functionality	150	27813 (58*)	-	-	-
	160	-	29150 (60*)	-	-
	180	-	-	31825 (70*)	-
	200	-	-	-	34513 (80*)

* Possible project size diagonals (in inches)



Trapezoid



615/13

Electrically adjustable height (73 - 139 cm)
Coated aluminum foot section, uprights and underframes coated

Polished aluminum foot section, coated uprights and underframes

Additional charge/reduced prices

Polished aluminum foot section, coated uprights and underframes

Bright chrome-plated aluminum foot section, uprights and underframes coated

Battery box: Lithium-ion battery with charger

Plastic lipping all the way round for laminate variant 1 (single color) and 2 **per running meter**

SEK

1450

2975


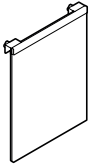
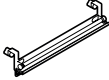
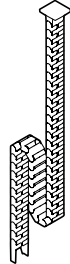

4250

-275

Table top group

	Width	Depth	
		75/90	75/100
1 Laminate variant 1	180	41050	-
	200	-	49850
1 Laminate variant 2	180	45363	-
	200	-	54138
2 Veneer variant 1	180	46413	-
	200	-	56850
2 Veneer variant 2	180	52175	-
	200	-	63888



		SEK
Battery box	615/01 Compact and powerful lithium-ion battery with charger, retrofittable	4250
 Whiteboard set pro	615/02 For Timetable Lift with whiteboard functionality, consisting of: 1 organizer bag made of gray felt to hang on the underframe or table top, 4 whiteboard pens in black, red, green, blue with a chisel tip 1 extra large cloth 40 x 40 cm 2 whiteboard erasers for occasional cleaning 10 magnets, Ø 34 mm, white 1 bottle of board cleaner, 250 ml pump-action spray	3325
 Monitor mount	615/03 White laminate table top, coated clamp, with a multipurpose Vesa mounting pattern for monitors up to 60" and max. weight of 28 kg* *Stable in compliance with DIN EN-1023-3: 2001-01. If the monitor weighs more than 15 kg, we recommend adding a tilt function to the table Accessories 615/30 Wall mount Coated steel	5425 1763
 Roll holder	615/04 for Timetable Lift models with straight edging sheet steel, coated with tear-off edge for 60 cm roll widths Accessories 615/40 Whiteboard films, roll with 25 sheets 615/41 Flipchart films, roll with 25 sheets 615/42 Paper roll length 10 m	SEK 2425 563 563 225
 Vertical cable management	615/05 Cable riser for the Timetable Lift upright, magnetic black or white plastic, length approx. 139 cm	1338
 Cable holder	615/06 for table top, made of black plastic, with hook and loop strap Magnetic base (2 items) Self-adhesive base (2 items)	438 250

Timetable Lift
Built-in component sets








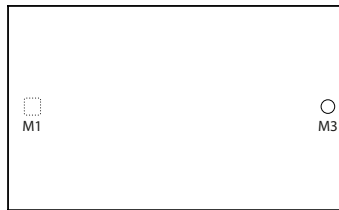
Mobile charging set 706/00 consisting of:	SEK	SEK
<p>Rechargeable battery pack Powerful, 240 Wh lithium-ion rechargeable battery, black mounted in a sheet steel cable channel, coated black, with an adaptor, incl. central supply lead 300 cm (When ordering, please state local standard)</p> 		
<p>USB A+C charger (optional)</p> 		
<p>Wireless charger (optional)</p> 		
<p>Set price for mobile charging set 706/00 with a USB charger</p> <p>17200</p> <p>USB A+C charger, with 72W max. output power USB type C max. 60W, USB type A max. 12W Body made of high strength, flame-retardant polycarbonate, black, fitted underneath the table edge</p>		
<p>Set price for mobile charging set 706/00 with 2 x USB chargers</p> <p>19263</p> <p>2 x USB A+C chargers, with 72W max. output power USB type C max. 60W, USB type A max. 12W Body made of high strength, flame-retardant polycarbonate, black, fitted underneath the table edge</p>		
<p>Set price for mobile charging set 706/00 with a wireless charger</p> <p>19675</p> <p>Wireless charger with max. output power 15W for express charging of Qi-enabled mobile devices surface made of black nylon with adhesive ring, waterproof and dustproof body Sets come fully assembled and wired. Power supply to recharge the rechargeable battery pack via a central supply lead</p>		
<p>Additional charge/reduced prices</p> <p>Cable riser for the Timetable Lift upright, magnetic black or white plastic, length approx. 139 cm</p> <p>1338</p>		
		<p>mod. 701/98 Techni-station Flow</p> <p>3700</p> <p>1 x power supply module (state local standard when ordering) with separate supply lead, length approx. 300 cm 1 x USB charger type A + type C with Smart IC and PD 2.0 to recharge up to two mobile devices fitted underneath the table edge</p> 
		<p>mod. 701/99 Wireless charger</p> <p>5350</p> <p>Wireless charger with adaptor, max. output power 15W, Qi-certified, for express charging of Qi-enabled mobile devices surface made of black nylon with adhesive ring, waterproof and dustproof body with central supply lead, length approx. 300 cm local standard (when ordering, please state local standard)</p> 
		<p>Additional charge/reduced prices</p> <p>Cable riser for the Timetable Lift upright, magnetic black or white plastic, length approx. 139 cm</p> <p>1338</p>

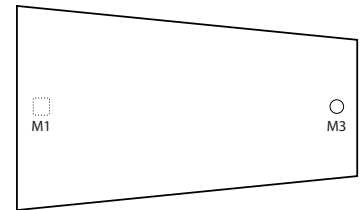


table width \geq 160 cm

615/00, 615/10, 615/11, 615/12



615/13



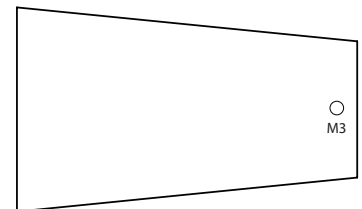
Set	Mounting position	M1	M3
Mobile charging 706/00 with a USB charger		•	•
Mobile charging 706/00 with 2 USB chargers		•	•
Mobile charging 706/00 with a wireless charger		–	•

table width \geq 160 cm

615/00, 615/10, 615/11, 615/12



615/13



Set	Mounting position	M3
701/98 Techni-station Flow		•
701/99 Wireless charger with adaptor		•

- available
- not available



The usage concept, aesthetic, innovative functionality and first-class materials determine the quality and the return on investment of conference furniture. Another important aspect is how multimedia equipment is integrated in the tables.

Whether static table configurations, variable table systems, or mobile and dynamic solutions are required – the superb aesthetic and functional quality of the table ranges should also offer options for adding

state-of-the-art multi-media equipment. Depending on the requirements, Wilkhahn table ranges can integrate anything that's required to use today's multi-media equipment with ease – from cable outlets to different types of techni-stations for plug and play solutions. As a result, customized solutions are produced where most of the technology is cleverly concealed and part of the table system.





Techni-stations, cable lids and cable outlets

When it comes to integrating the outlets into the table top there are several solutions: Compact, fitted modules that are space-saving to integrate and can be customized with different ports. Pop-up or fold-out techni-stations with plug-and-play outlets are easy to handle, cables and adapters also stay on the table top in this case too. The high-quality cable lids coordinate especially well with the table.

Even when equipment is connected, only a small strip is visible. The outlets are underneath the table, so that residual cable and chargers can be accommodated in the horizontal cable management sets. Flexible techni-stations can be attached to the table edge without requiring any tools.

If cables are to be inserted through the table top, outlets are available that range from simple plastic to high-quality aluminum solutions.

Integrated techni-station basic



Clear anodized, aluminum body, plastic side sections similar to RAL 9006, black plastic modules. With integrated rubber profile or optionally with integrated brushed profile for cable outlet when closed. Frame surface mounted with hinge mechanism. Pre-wired, including cable. On request, with mechanism that opens by pressing the top. On request, cable harness covered with a black textile sleeving. Optionally with the following ports:

701/00 **3 modules:**
 2 x power supply modules (please state the local standard when ordering) with supply lead approx. 300 cm long
 1 x data module with 2 x RJ45 jacks (category 6 shielded) with permanently attached patch cables approx. 350 cm long or optionally with USB charger type A + type C with Smart IC and PD 2.0 to recharge up to two mobile devices.

701/10 **4 modules:**
 2 x power supply modules (please state the local standard when ordering) with supply lead approx. 300 cm long
 1 x data module with 2 x RJ45 jacks (category 6 shielded) with permanently attached patch cables approx. 350 cm long
 1 x module with VGA jack (15 pin D-sub) + 3.5 mm stereo jack or optionally HDMI jack with permanently attached cables, approx. 300 cm long

Integrated techni-station rotate



Clear anodized, aluminum body, plastic side sections similar to RAL 9006, black plastic modules. Frame flush-fitted with rotate to expose mechanism. Pre-wired, including cable. On request, with mechanism that opens at the touch of a button. On request, cable harness covered with a black textile sleeving. Optionally with the following ports:

701/60 **3 modules:**
 2 x power supply modules (please state the local standard when ordering) with supply lead approx. 300 cm long
 1 x data module with 2 x RJ45 jacks (category 6 shielded) with permanently attached patch cables approx. 350 cm long or optionally with USB charger type A + type C with Smart IC and PD 2.0 to recharge up to two mobile devices.

701/70 **4 modules:**
 2 x power supply modules (please state the local standard when ordering) with supply lead approx. 300 cm long
 1 x data module with 2 x RJ45 jacks (category 6 shielded) with permanently attached patch cables approx. 350 cm long
 1 x module with VGA jack (15 pin D-sub) + 3.5 mm stereo jack or optionally HDMI jack with permanently attached cables, approx. 300 cm long



Integrated techni-station compact



701/95

Die-cast zinc installation frame, matte chrome. Frame attached, optionally round or square to fit different modules. The various modules are slotted into the installation frame without any tools. On request, cable harness covered with a black textile sleeving. Optionally with the following ports:



Cable outlet square for installation frame

Matte chrome cable outlet with brushed profile



Wireless charging module

1 x slot with a wireless charging module (5 watt, Qi compliant) for wireless charging of suitable mobile devices with an approx. 180 cm supply lead and power supply unit



Power supply module

1 x power supply module (when ordering please state the local standard) with 40 cm supply lead, mod. 708/8
2 x slots with cover for optional Keystone modules



Power supply module and USB port

1 x power supply module (when ordering please state the local standard) with 40 cm supply lead, mod. 708/8
1 x USB port with Smart IC to charge mobile devices at their optimal rates (max. charging current 2A) as quickly as possible
1 x slot with cover for optional Keystone modules



Optional

Keystone modules as thru-type coupling, exchangeable, without leads: RJ 45 jack (category 6) or HDMI jack

Integrated techni-station compact duo



701/96

Die-cast zinc installation frame, matte chrome. Fitted installation frame, rectangular frame to fit two exchangeable ports. The various modules are slotted into the installation frame without any tools. On request, cable harness covered with a black textile sleeving. Optionally with the following ports:



Cable outlet

Matte chrome cable outlet with brushed profile



Wireless charging module

1 x slot with a wireless charging module (5 watt, Qi compliant) for wireless charging of suitable mobile devices with an approx. 180 cm supply lead and power supply unit



Power supply module

1 x power supply module (when ordering please state the local standard) with 40 cm supply lead, mod. 708/8
2 x slots with cover for optional Keystone modules



Power supply module and USB port

1 x power supply module (when ordering please state the local standard) with 40 cm supply lead, mod. 708/8
1 x USB port with Smart IC to charge mobile devices at their optimal rates (max. charging current 2A) as quickly as possible
1 x slot with cover for optional Keystone modules



Optional

Keystone modules as thru-type coupling, exchangeable, without leads: RJ 45 jack (category 6) or HDMI jack



Techni-station Compact Add



701/97

Flexible techni-station for tool-free assembly on the table edge using a knurled screw. Can be used on straight and bullnose lipping (for table top thicknesses from 12 - 30 mm). Robust metal housing, coated similar to RAL 9006, black plastic modules, pre-wired and including cable. On request, cable harness covered with a black textile sleeving. Optionally with the following ports:



Power supply module

1 x power supply module (when ordering state the local standard) with supply lead approx. 270 cm long
2 x slots with cover for optional Keystone modules



Optional

Keystone modules:

RJ 45 jack (category 6) with permanently attached cable, approx. length 330 cm or
HDMI jack with permanently attached cable, approx. 270 cm in length

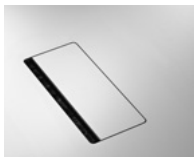


Cable outlets



707/1 Cable outlet
Black plastic, Ø 80 mm

Cable lid Executive



Cable lid with brushed profile the same color and material as the table top on both sides. Cut out section with real wood lipping all the way round, color-matched as far as possible with the table top.
Cable lid 300 x 150 mm, (inside dimensions 300 x 150 mm) flush-fitted, hinges open at 180°.

In conjunction with the socket strips there are lots of connection options.

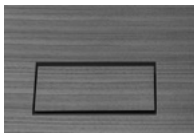
Cable lid Basic



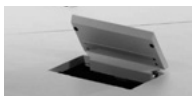
Aluminum installation frame with cable lid and brushed profile
Frame attached, cable lid 300 x 120 mm, (inside dimensions 270 x 90 mm) opens at 90°.

In conjunction with the socket strips there are lots of connection options.

Cable lid Graph



300/01 **Cable lid opening lengthwise**
beveled on both of the long sides (can be used on both sides), gas-lift damped, automatic opening mechanism, Cable lid color and material the same on both sides.
Cable lid: 300 x 165 mm (Inside length of Graph cable lid: 300 x 120 mm)



300/02 **Cable lid opens sideways**
beveled on one of the long sides (can be used from one side), gas-lift damped, automatic opening mechanism, Cable lid color and material the same on both sides.
Cable lid: 300 x 165 mm (Inside width of Graph cable lid: 300 x 138 mm)



Socket strips



Socket strip made of sturdy, black plastic, to fit underneath the cable lid executive and basic. Depending on the table range and mounting position, can be fitted to a mount, in a cable channel or underframe. The appropriate assembly materials are included in the sets.

Body at the side with 230 V input and output (plug + GST18/3 jack) to connect supply and extension leads, mod. 708/8 and 708/9.

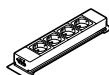
Optionally with the following ports:



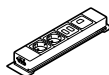
708/1 Socket strip
3 modules:
3 x power supply modules (please state the local standard when ordering)



708/2 Socket strip
3 modules:
2 x power supply modules (when ordering please state the local standard).
1 x data module with 2 x RJ45 jack (category 6, shielded)
with permanently attached patch cables approx. 350 cm long
or optionally with USB charger type A + type C with Smart IC and PD 2.0 to recharge up to two mobile devices.

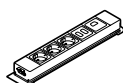


708/4 Socket strip
4 modules:
4 x power supply modules (please state the local standard when ordering).



708/5 Socket strip
4 modules:
2 x power supply modules (when ordering please state the local standard).
1 x data module with 2 x RJ45 jack (category 6, shielded)
with permanently attached patch cables approx. 350 cm long

1 x module for a VGA connector (D-sub 15 pin) + stereo jack 3.5 mm, or optionally HDMI jack with permanently attached cables approx. 300 cm long



708/6 Socket strip
5 modules:
3 x power supply modules (when ordering please state the local standard).
1 x data module with 2 x RJ45 jack (category 6, shielded)
1 x data module with 1 x RJ45 jack (category 6, shielded)
with permanently attached patch cables approx. 350 cm long



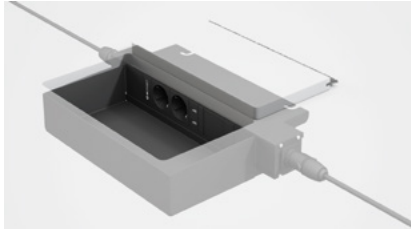
708/8 Supply lead
3 x 1.5 mm², black
Schuko right angle plug + GST18/3 jack
Length optionally approx. 200, 300 or 500 cm



708/9 Extension lead
3 x 1.5 mm², black
Plug + GST18/3 jack
Length optionally approx. 200 or 300 cm



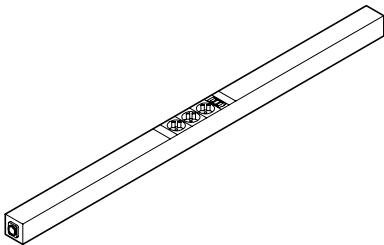
Power Bar



Linkable connection system for mobile table ranges.

Socket strip made of black or white coated aluminum, modules made of sturdy, black or white plastic, can be fitted underneath the Executive and Basic single table portal. Can be fitted to the cable channel or underframe, depending on the table range and mounting position. The appropriate assembly materials are included in the sets.

Body with inputs and outputs at the side for Neutrik-powerCON® cable, mod. 702/8 and 702/9. The connector system with locking action and strain relief means that connecting to the power supply is safer, easy and fast.



704/10

Body optionally in black or white
mit input/output for Neutrik-powerCON® cable
1 x power supply module (when ordering please state the local standard)
3 x configurable blank sections

704/10 3 x configurable blank sections

Power and charging fields must be configured directly after one another



Power supply module (when ordering, please state local standard)



Dual USB-A charging, 1/2 module



Dual USB-C and USB-A charging, 1/2 module



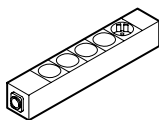
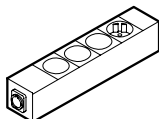
USB-C power charging 60W, module



Blanking plate, 1/2 module



Blanking plate, module



704/00

Body optionally in black or white
 mit input/output for Neutrik-powerCON® cable
 1 x power supply module (when ordering please state the local standard)
 3 x configurable blank sections

705/00

Body optionally in black or white
 mit input/output for Neutrik-powerCON® cable
 1 x power supply module (when ordering please state the local standard)
 4 x configurable blank sections

704/00 and 705/00 3 x configurable blank sections

Power and charging fields must be configured directly after one another



Power supply module (when ordering, please state local standard)



Dual USB-A charging, 1/2 module



Dual USB-C and USB-A charging, 1/2 module



USB-C power charging 60W, module



USB 3.0-data, Keystone module, 1/2 module



USB-C data (1/2 module) with approx. 30 cm cable



RJ45 network, CAT 6, Keystone module, 1/2 module



Twin network RJ45, CAT 6, Keystone module, module



HDMI, Keystone module, 1/2 module



Blanking plate, 1/2 module



Blanking plate, module



702/8

Supply lead
 Neutrik-powerCON®, black
 Schuko right angle plug + Neutrik-powerCON®
 Length optionally approx. 200, 300 or 500 cm



702/9

Extension lead
 Neutrik-powerCON®, black
 Neutrik-powerCON® IN + Neutrik-powerCON® OUT
 Length optionally approx. 80, 100, 150 or 300 cm

Optional

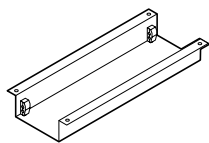
Patch cable CAT6, length approx. 200 cm
 Patch cable CAT6, length approx. 300 cm
 USB 3.0 data cable, length approx. 300 cm
 USB type C data, connecting cable, length approx. 300 cm
 HDMI cable, length approx. 300 cm



Cable management

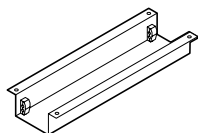
Options for cable management sets are just as varied. For horizontal management underneath the table, such cable management sets and retractable cable baskets or -channels are recommended that contain the technical components. Cables can be inserted vertically in the table legs, via external cable clips or textile sleeving.

Horizontal cable management sets



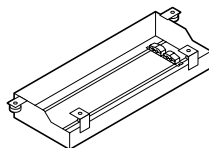
Cable cover for integrated techni-station basic, models 701/00 and 701/10

made of aluminum sheet, attached to the table top, coated black, with strain relief on both sides, length 550 mm



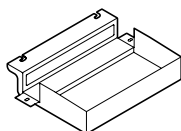
Cable cover for integrated techni-station rotate, models 701/60 and 701/70

made of aluminum sheet, attached to the table top, coated black, with strain relief on both sides, length 550 mm



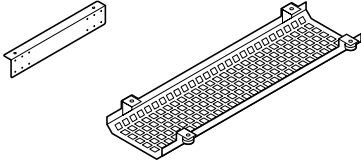
Cable channel for cable lid executive or basic, to integrated a socket strip models 708/1 to 708/6

made of aluminum extruded profile, retractable, coated black with strain relief and insertion plates to integrate the socket strip, length 540 mm

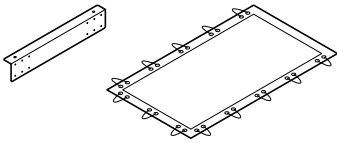


Cable channel for Executive or Basic cable lid, to attach a Power Bar socket strip mod. 702/00

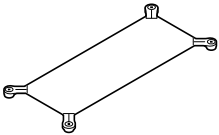
made of sheet steel, coated black, length 358 mm, with black sponge rubber lining, optionally with extra bumper made of sponge rubber on the bottom (for mod. 610)



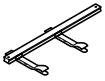
Cable basket for cable lid executive or basic, for socket strip models 708/1 to 708/6
curved, perforated metal basket, retractable, black coated, to fit underneath the table top, with mount for socket strip, metal brackets, coated black



Storage mesh for executive or basic cable lid for socket strip models 708/1 to 708/6
Black polyester to match the table length, with mount for socket strip, metal brackets, coated black



Storage mesh for 460 mAx/465 mAx light table range for integrated techni-station compact
Black polyester, length 430 mm



Cable holder underneath the table top with hook and loop fasteners
Anodized aluminum profile with 2 polypropylene cable clips attached; with hook and loop straps



Vertical cable management sets



Cable clip for the table leg

made of black, fiberglass-reinforced polyamide for cable management on the table frame's upright.



Textile sleeving for cable harness

belonging to the techni-stations or socket strips



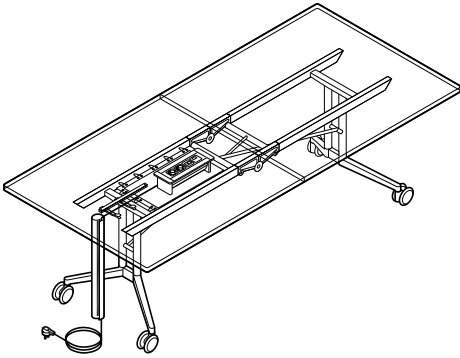
Vertical cable channel mod. 620/2

for cable management between the uprights in the Logon 620 range,
coated in black or a silver satin finish

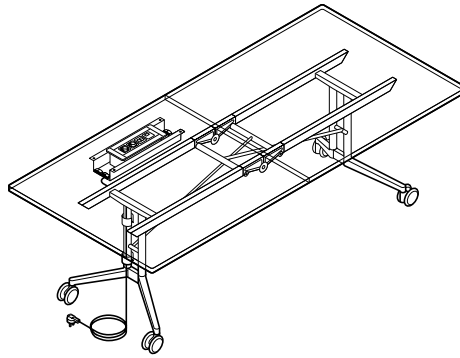


Examples of how techni-stations and cable lids and their cable management systems are integrated

Confair Folding table

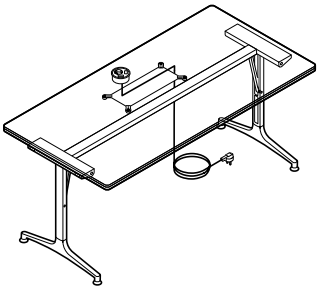


Integrated techni-station rotate, cable management with hook and loop fasteners, cable harness covered with a black textile sleeving.



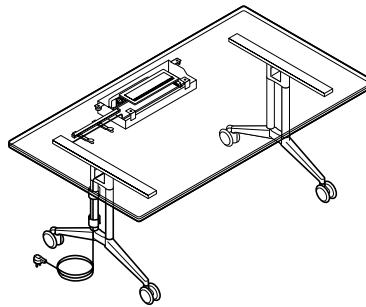
Integrated techni-station rotate set, with cable management cover and cable clips on the table leg

mAx|mAx light



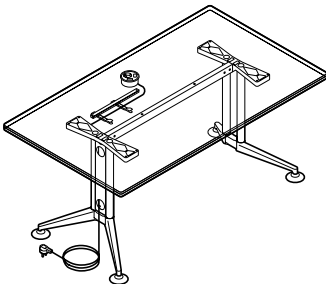
Integrated techni-station compact set, with storage mesh

Timetable Shift

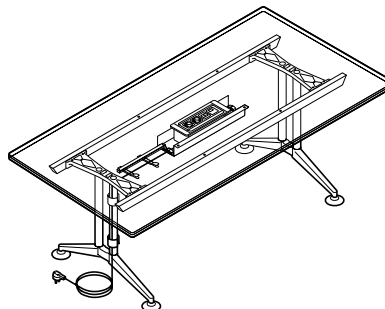


Cable lid set with cable management cover
cable management with hook and loop fasteners,
cable clip on the table leg

Logon



Integrated techni-station compact set,
cable management with hook and loop fasteners,
vertical cable channel



Integrated techni-station rotate set,
with cable management cover, cable management with
hook and loop fasteners and cable clips on the table leg



Edging matrix.

Wilkhahn has more than 135 different types of wood-based table tops to choose from, available as standard and customized versions.

The edging matrix indicates which edging types can or cannot be made for a particular table range in the different surface finishes and thicknesses, or require prior clarification.

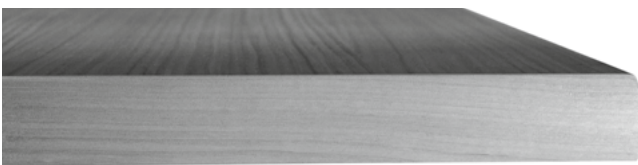
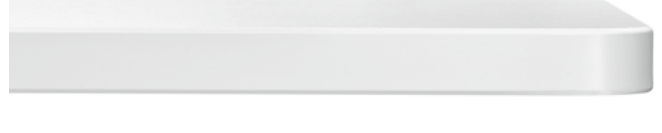
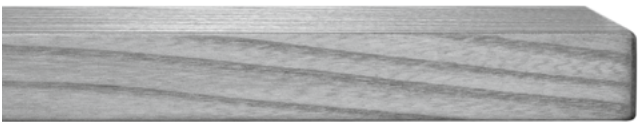
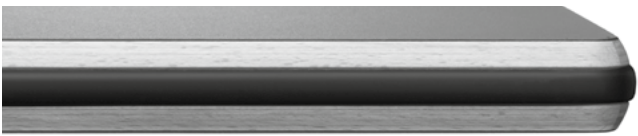
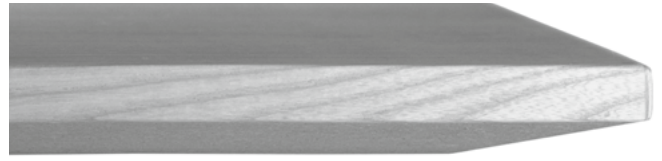
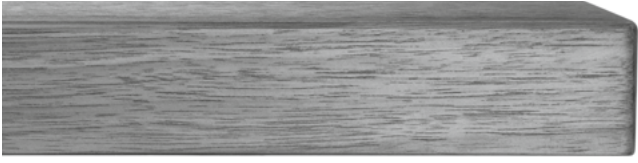
Concealed lipping is oversailing veneer. Visible lipping is pre-glued lipping.

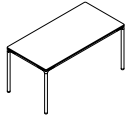
Laminate

- Edge always with a natural oiled finish
- The edge is varnished in the same color as the table top, concealed lipping is only available as a customized solution

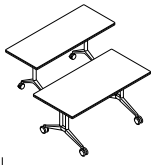
Veneer

- Table top and edging mostly stained and varnished in the same color





540 Contas



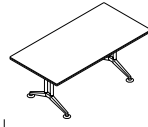
610 Timetable
614 Timetable
Shift



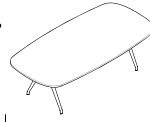
612 Timetable Smart



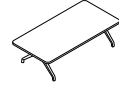
615 Timetable Lift



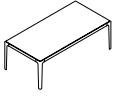
620 Logon



636 Versa



780 Insit



860 Asienta

540 Contas		610 Timetable 614 Timetable Shift		612 Timetable Smart			615 Timetable Lift		620 Logon		636 Versa		780 Insit		860 Asienta			
1 Laminate	2 Veneer	1 Laminate	2 Veneer	1 Laminate	2 Veneer	5 Direct coating	1 Laminate	2 Veneer	Board-Funktion	1 Laminate	2 Veneer	1 Laminate	2 Veneer	1 Laminate	2 Veneer	7 Through-dyed HPL	2 Veneer	10 Glass
●	●	○	○	○	○		○	○		○	○							
		○	○	○	○		○	○		○	○							
		○	○	○	○		○	○		○	○							
		●	●	●	●		●	●		●	●							
		○	○	○	○		○	○		○	○	●	●	●	●		●	
													●					
													●					
		●		●		●	●		●	●		●		●				
								●										
																●		

Wilkhahn®

Wilkening + Hahne GmbH+Co. KG
Fritz-Hahne-Straße 8
31848 Bad Münder
+ 49 (0) 5042 999-0
+ 49 (0) 5042 999-226
info@wilkhahn.de
www.wilkhahn.de

Australia
Wilkhahn Asia Pacific
Head Quarters
Wilkhahn Forum Sydney
74 Wentworth Avenue
Surry Hills NSW 2010
+ 61 2 9310 3355
info@wilkhahn.com.au
www.wilkhahn.com.au

Wilkhahn Forum Brisbane
Level 2, 17 Byres Street
Newstead QLD 4006
+ 61 7 3369 2088
info@wilkhahn.com.au
www.wilkhahn.com.au

Wilkhahn Forum Melbourne
477 Collins St
Melbourne VIC 3000
+ 61 3 9670 5570
info@wilkhahn.com.au
www.wilkhahn.com.au

Belgium
Wilkhahn
Havenlaan 86C
1000 Brussel
+ 32 3 232 93 91
+ 32 3 227 16 16
info@wilkhahn.be

China
Wilkhahn Asia Pacific
Room 301, Floor 3
83 Fu Min Rd | Shanghai Jing
An District
Shanghai 200000
+ 86 21 5466 1919
+ 86 21 5465 1642
info@wilkhahn.com.cn
www.wilkhahn.com.au

España
Wilkhahn S. A.
C/Fidias, 4 Bajo
28011 Madrid
+ 34 60 96 65 793
info@wilkhahn.es
www.wilkhahn.es

Great Britain
Wilkhahn Ltd.
Wilkhahn Forum London
45 Great Sutton Street
London EC1V 0DE
+44 (0) 207 324 2900
+44 (0) 207 324 2901
info@wilkhahn.co.uk

Hong Kong
Wilkhahn Asia Pacific
Wilkhahn Forum Hong Kong
Rooms 4505-7, 45/F
China Online Centre
No. 333 Lockhart Road
Wanchai
+ 852 2827 0800
+ 852 2827 0855
info@wilkhahn.com.hk
www.wilkhahn.com.hk

Japan
Wilkhahn Japan Co., Ltd.
Wilkhahn Forum Tokyo
Tokyotatemono Aoyama
Building B1 3-3-5
Kitaoyama, Minato-ku
107-0061 Tokyo
+ 81 (0) 3 5414 8088
+ 81 (0) 3 5414 8089
info@wilkhahn.co.jp
www.wilkhahn.co.jp

Maroc
Maroc Bureau
Autoroute de Rabat -
Km 9,200
Ain Sebaâ - Casablanca
20260
+212 5 22 35 37 55
+212 5 22 35 51 25
info@maroc-bureau.com

Nederland
Wilkhahn B.V.
Van Nelle Fabriek
Van Nelleweg 2120
3044 BC Rotterdam
+31 10 750 33 90
info@wilkhahn.nl

Österreich
Wilkhahn Handelsges.m.b.H.
Ankerbrot-Fabrik
Absberggasse 27, Stg. 7/7.11A
1100 Wien
+ 43 1 894 21 68-0
+ 43 1 890 32 39-15
info@wilkhahn.at

Schweiz
Wilkhahn AG
Postgasse 17
Postfach 808
3000 Bern 8
+ 41 31 310 13 13
info@wilkhahn.ch
www.wilkhahn.ch

Singapore
Wilkhahn Asia Pacific
Wilkhahn Forum Singapore
20 Martin Road
#05-02 Seng Kee Building
Singapore 239070
+ 65 622 111 86
+ 65 622 111 25
info@wilkhahn.com.sg
www.wilkhahn.com.sg

South Africa
Classic Working Life
43 Houghton Drive,
Houghton Estate
2198 Johannesburg
+27 (0) 11 728 9542
info@classicwl.co.za
www.classicwl.co.za

United States of America
Wilkhahn Lab
Wilkhahn Inc.
10 Greene Street
New York, NY 10013
+ 1 212 229 9455
+ 1 212 229 4772
sales@wilkhahn.com
www.wilkhahn.com/en-us

