

Price List

Valid from the 1st of April 2024
edition 1

All prices: SEK

ADDA RAMAVTAL

SENAB

Färgmarkeringar och/eller symboler för hållbara alternativ i prislistan:

Mörkgrön markering eller symbol

Miljömärkt produkt – Möbler där hela den sammansatta varan har en typ 1 miljömärkning enligt ISO 14024 med Svanen, Möbelfakta, EU Ecolabel eller annan likvärdig märkning.

Ljusgrön markering eller symbol

Hållbarhetsmärkt produkt eller beståndsdel – Möbler där hela eller delar av den sammansatta varan är hållbarhetsmärkt, exempelvis med FSC, EU Ecolabel eller OEKO-TEX®. Leverantören ska kunna ge mer detaljerad information om vilka delar eller variationer som är hållbarhetsmärka vid begäran.

Orange markering eller symbol

Klimatberäknad produkt – Produkt med dokumenterad miljövarudeklaration (EPD) enligt ISO 14025.

Lila markering eller symbol

Produkt med återvunnet eller förnybart material (enligt definitionerna i ISO 14021). Leverantören ska kunna ge information om andel (%) återvunnet och/eller förnybart (biobaserat) vid begäran. Märkning av återvinningsbart material utgår.

Blå markering eller symbol

Demonterbar produkt – Produkt som är demonterbar till olika komponenter och beståndsdelar som i första hand möjliggör återbruk och i andra hand materialåtervinning när produkten nått sin fulla livslängd. Produkten ska vara designad för renovering, det vill säga att det ska vara enkelt att reparera och byta ut moduler, komponenter och beståndsdelar som slits över tid. Exempelvis ska ytskikt, som bordsskivor, textil och stoppning kunna tas isär, avlägsnas och ersättas med hjälp av vanligt förekommande manuella verktyg, ej specialverktyg. Enklare reparationer och utbytesarbeten ska kunna utföras av en lekman. Om det krävs fackmanakunskap för mer avancerade arbeten ska det framgå av anvisningarna som leverantören ska kunna ge vid begäran. Anvisningarna ska innehålla en sprängskiss, steg för steg beskrivning inklusive vilka verktyg som krävs samt hur möbelns ingående delar bör källsorteras.

Contents

Order entry specifications

Profim MICKEY   

Profim TRILLO PRO     

Visitor chairs

Profim ANA     

Profim ARIZ   

Profim BIT   

Profim COM   

Profim NOOR 4-LEG     

Profim NOOR SLEDGEBASE     

Profim NOOR FOOTBASE     

Profim NOOR WOODEN LEGS     

Profim NOOR UP     

Profim NORMO     

Profim ZOO   

Sofas, armchairs, modular systems

Profim CHIC   

Profim CHIC LOUNGE     

Profim ELLIE PRO     





Profim FAN     

Profim NU   

Profim REVO     

Profim SORRISO   

Profim VANCOUVER LITE     

Profim VANCOUVER OTO    

Profim WALL IN   

Tables, coat stands and accessories

Profim ALLROUND  

Profim EMINENT  

Profim REVO TABLES     

Profim STANDARD FOLDING TABLE   

Profim U-CONNECT   

Profim SEVEN    

Technical details

Fabrics and finishings

Profim Standard fabrics

Fabrics and finishings - Extended Legend

Armchairs

Swivel chairs

Pouffes

Profim MICKEY

ITO Design

- It is a unique combination of a pouffe and a swivel stool with height adjustment
- Totally intuitive and easy to use
- Provides support by tilting from side to side (range of 10 degrees in each direction)
- Three colours of plastic parts
- Möbelfakta certificate - a guarantee of durability, safety, environmental care and social responsibility during the production process

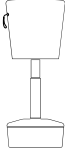
Item no	Base model +	Price Group (PG)	Price Group						Price
			0	①	②	③	④	⑤	
MMC0000000	Profim MICKEY <ul style="list-style-type: none"> • stool, swivel with height adjustment and sideways tilt 10° • base: lightgrey (RAL 7047) / grey (RAL 7043) / beige (RAL 7036) 		3 720	3 876	4 263	4 457	4 648	5 424	6 527

0 price group: Evo

1 price group: Cura, Tonal, Xtreme

2 price group: Select

3 price group: Capture, Oceanic, Step, Synergy

4 price group: Steelcut 3, Steelcut Trio 3

Base: lightgrey (RAL 7047) / grey (RAL 7043) / beige (RAL 7036) - when ordering please clearly indicate the chosen option.

Glides:

- teflon glides - universal (set).

When ordering please clearly indicate the chosen option.

The sides of the base can be made of:

- the same fabric as the seat,

- plastic in the same colour as the rest of plastic elements.

Please clearly indicate on your order the chosen option.

Handle for height adjustment is always made of the same fabric as the rest of the seat.





Plastic elements and the cover of the gas lift are made of different materials therefore their colour might vary slightly.



Profim TRILLO PRO

ITO Design

- Easily adjustable basic functions.
- Synchro self mechanism ensures adjustment to user's weight,
- Several versions to choose from: backrest in plastic or with upholstered pad, plastics in two colours,
- Blue Angel certificate - confirms that our chair is environmentally friendly

Item no	Base model +	Price Group (PG)	0	①	②	③	④	⑤	Price
MSX200ST00	Profim TRILLO PRO 20ST <ul style="list-style-type: none"> • plastic backrest • self mechanism • 5-star base • base: black 		2 782	3 010	3 118	3 242	3 504	3 616	
MSX210ST00	Profim TRILLO PRO 21ST <ul style="list-style-type: none"> • plastic backrest with upholstered pad • self mechanism • 5-star base • base: black 		3 252	3 576	3 791	3 943	4 504	4 398	
MSX200HS00	Profim TRILLO PRO 20HST <ul style="list-style-type: none"> • plastic backrest • self mechanism • 4-star base, high • base: black / white / graphite / polished aluminum / MetallicPro 		3 780	4 036	4 168	4 327	4 582	4 837	
MSX210HS00	Profim TRILLO PRO 21HST <ul style="list-style-type: none"> • plastic backrest with upholstered pad • self mechanism • 4-star base, high • base: black / white / graphite / polished aluminum / MetallicPro 		4 279	4 655	4 910	5 105	5 712	5 688	

Accessories/Options/Surcharges:

7BASC006	Base: lightgray (Only for: MSX200ST00, MSX210ST00)	230
----------	--	-----

0 price group: Evo

1 price group: Cura, Tonal, Xtreme

2 price group: Select

3 price group: Capture, Oceanic, Step, Synergy

4 price group: Steelcut 3, Steelcut Trio 3

Castors/glides:

- glides (set)
- hard castors - for soft floors (set),
- soft castors - for hard floors (set).

Plastic colours:- black, grey (RAL 7043), light grey (RAL 7047).

Plastic elements: backrest and armrests.

In models 20HST / 21HST:

- base colour black / MetallicPro - plastic elements black, castors black,
- base colour white - plastic elements lightgrey (RAL 7047), castors lightgrey,
- base colour graphite - plastic elements black or grey (RAL 7043), castors black,
- base colour polished aluminium - plastic elements black, grey (RAL 7043) and castors black or plastic elements light grey (RAL 7047) and castors lightgrey.

Please clearly indicate on your order the chosen option.





www.blauer-engel.de/uz117

Visitor chairs

Profim ANA

Tias Eckhoff

- Polypropylene (PP) shell in various colours.

Item no	Base model +	Price Group (PG)	Price Group						Price	
			0	①	②	③	④	⑤		⑥
4340	Profim ANA 4340 • Without upholstery									742
4340s	Profim ANA 4340s • Upholstered seat		1 188	1 193	1 250	1 405	1 606	1 808	2 462	
4340sr	Profim ANA 4340sr • Upholstered seat and back		1 552	1 589	1 634	1 955	2 385	2 730	3 730	
Accessories/Options/Surcharges:										
3YES	Linking device, welded. Must be specified at time of order. Can not be retrofitted.									124
PD303	Felt glides - 4 units.									39

0 price group: Alba, Evo, Next,

1 price group: Cura, Tonal, Xtreme

2 price group: Select

3 price group: Capture, Oceanic, Step, Synergy

4 price group: Steelcut 3, Steelcut Trio 3

Frame of 19 x 1.5 mm tubular steel available in various colours.

Weight 3.7 kg model 4340.

Height: Seat 430 mm, Back 400 mm, Chair width 490 mm, Chair height 825 mm, Chair depth 515 mm.

Stackable up to 12 chairs without upholstery (height: 1.83 m), 10 chairs with seat upholstery (height: 1.65 m) and 7 chairs with seat and back upholstery.

Can be linked together using linking device - see options.

Table suspension Profim Ana. See Profim Eminent table.

Graphite shell colour in recycled PP.



S=Standard Collection – normal delivery time from factory 10-15 working days. Applicable when all component options (fabric, shell, frame/legs) are standard(S).







E=Extended Collection – normal delivery time from factory 20-30 working days. Applicable when any or all component options selected are extended (E).





For larger orders, please contact Customer Service for delivery details.



Profim ARIZ

- Wide configuration possibilities with several plastic colours and a wide range of upholstery fabrics
- Plastic, upholstered, and mesh versions.
- Version with comfortable armrest available
- Possibility of high stacking (up to 45 pieces on a special trolley for chair transport)
- Option to join in rows, mount writing top and newspaper basket
- Möbelfakta certificate - a guarantee of durability, safety, environmental care and social responsibility during the production process

Item no	Base model +	Price Group (PG)	0	①	②	③	④	⑤	Price
MWE500V000	Profim ARIZ 550V • plastic seat and backrest • frame: black								1775
MWE550V000	Profim ARIZ 555V • plastic seat • mesh backrest • frame: black								2115
MWE600V000	Profim ARIZ 560V • upholstered seat • plastic backrest • frame: black		2005	2139	2248	2334	2540	2613	
MWE700V000	Profim ARIZ 570V • upholstered seat and backrest • frame: black		2382	2625	3002	3124	3902	3476	
MWE750V000	Profim ARIZ 575V • upholstered seat • mesh backrest • frame: black		2395	2540	2638	2735	2953	3063	
MWE500CV00	Profim ARIZ 550CV • bar stool • plastic seat and backrest • frame: black								2467

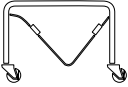
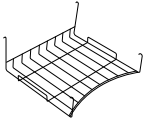
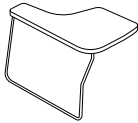
Item no	Base model +	Price Group (PG)	0	①	②	③	④	⑤	Price
MWE550CV00	Profim ARIZ 555CV • bar stool • plastic seat • mesh backrest • frame: black								2722
MWE600CV00	Profim ARIZ 560CV • bar stool • upholstered seat • plastic backrest • frame: black		2 662	2 820	2 953	3 063	3 246	3 428	
MWE700CV00	Profim ARIZ 570CV • bar stool • upholstered seat and backrest • frame: black		3 039	3 318	3 695	3 841	4 594	4 279	
MWE750CV00	Profim ARIZ 575CV • bar stool • upholstered seat • mesh backrest • frame: black		3 051	3 233	3 330	3 464	3 646	3 853	
MWE000W000	Profim ARIZ Chairs' trolley (W)								3 659
MPDWEKO000	Profim ARIZ Newspapers bin (K)								438
MPDWEBL000	Profim ARIZ Table top (B)								1 373

Accessories/Options/Surcharges:

7COPR002	Frames colours: MetallicPro, White RAL 9016, Deep Green RAL 6004, Navy Blue RAL 5003, Burgundy RAL 3005, Salvia/Green RAL 6021, Blue RAL 5014, Terracota RAL 3012 (Only for: 550CV, 550V, 555CV, 555V, 560CV, 560V, 570CV, 570V, 575CV, 575V)	36
7COPR003	Frames colours: Lightgrey NCS S 2500-N; Grey NCS S 6500-N (Only for: 550CV, 555CV, 555V, 560CV, 560V, 570CV, 570V, 575CV, 575V)	218
7COPR003	Frames colours: Lightgrey NCS S 2500-N; Grey NCS S 6500-N (Only for: 550V)	1 641
7ARMR001	Armrests - metal, polypropylene pad (set) (Only for: 550V, 555V, 560V, 570V, 575V)	790

0 price group: Evo

1 price group: Cura, Tonal, Xtreme

2 price group: Select

3 price group: Capture, Oceanic, Step, Synergy

4 price group: Steelcut 3, Steelcut Trio 3

Glides:

- standard - teflon glides (universal),
- option - felt glides (for hard floors).

When ordering please clearly indicate the chosen option.

Colours of plastics:

black (CODE 01), white (CODE 20), gray blue (CODE 503), olive green (CODE 513), red (CODE 3020), navy (CODE 516), ashen (CODE 517).

In models Ariz 555/575 backrest frame only in colours: black, white and ashen.

Available versions with mesh backrest (in Ariz 555 model):

- black plastic seat (CODE 01) + black backrest frame (CODE 01) + black mesh,
- white plastic seat (CODE 20) + white backrest frame (CODE 20) + black mesh,
- ashen plastic seat (CODE 517) + ashen backrest frame (CODE 517) + black mesh.

In standard there is no option of different colours of backrest and seat.

Type of mesh: GZ.

Accessories only for 550V / 555V / 560V / 570V / 575V models:

- Chairs' trolley - frame colour is always black.
- Table top (B) - assembled on the left or right hand, available in chairs without armrests only, table top's frame colour is always chrome.
- Newspapers bin (K) - mounted under the seat, colour is always chrome.



Profim BIT

- Cantilever- or leg-mounted version
- Stackable
- Option to join in rows
- Choice of plastic or upholstered seat and plastic, mesh or upholstered backrest

Item no	Base model +	Price Group (PG)	0	①	②	③	④	⑤	Price
MBT500H000	Profim BIT 550H • 4-legged • plastic seat and backrest • frame: black								1775
MBT500V000	Profim BIT 550V • cantilever • plastic seat and backrest • frame: black								2248
MBT550H000	Profim BIT 555H • 4-legged • plastic seat • mesh backrest • frame: black								2188
MBT550V000	Profim BIT 555V • cantilever • plastic seat • mesh backrest • frame: black								2588
MBT600H000	Profim BIT 560H • 4-legged • seat upholstered pad • plastic backrest • frame: black		2 152	2 443	2 710	2 820	3 014	3 135	
MBT600V000	Profim BIT 560V • cantilever • seat upholstered pad • plastic backrest • frame: black		2 613	2 869	3 185	3 318	3 476	3 695	

Item no	Base model +	Price Group (PG)	0	①	②	③	④	⑤	Price
MBT700H000	Profim BIT 570H • 4-legged • seat and backrest • upholstered pads • frame: black		2 431	2 808	3 391	3 525	3 998	3 938	
MBT700V000	Profim BIT 570V • cantilever • seat and backrest • upholstered pads • frame: black		2 856	3 282	3 841	3 986	4 461	4 449	
MBT750H000	Profim BIT 575H • 4-legged • seat upholstered pad • mesh backrest • frame: black		2 528	2 808	3 087	3 221	3 415	3 573	
MBT750V000	Profim BIT 575V • cantilever • seat upholstered pad • mesh backrest • frame: black		2 990	3 269	3 549	3 695	3 841	4 120	
MBT800H000	Profim BIT 580H • 4-legged • seat and backrest fully upholstered • frame: black		2 431	3 367	4 631	4 813	5 445	5 360	
MBT800V000	Profim BIT 580V • cantilever • seat and backrest fully upholstered • frame: black		2 856	3 829	5 092	5 287	5 907	5 907	
Accessories/Options/Surcharges:									
7ARMR001	Armrests - plastic, always black (set)								365
7SEQU001	Quilting - pad or front side of the seat (Q1) (Only for: MBT600H000, 560V, 570H, 570V, 575H, 575V)								474
7BAQU001	Quilting - pad or front of the backrest (Q2) (Only for: 570H, 570V)								389

0 price group: Evo

1 price group: Cura, Tonal, Xtreme

2 price group: Select

3 price group: Capture, Oceanic, Step, Synergy

4 price group: Steelcut 3, Steelcut Trio 3

Glides:

- standard - teflon glides (universal),
- option - felt glides (for hard floors).

When ordering please clearly indicate the chosen option.

Plastic of backrest and seat - always black.

Backrest mesh - always black.

Types of mesh: Runner.







Quilting - extra charge to all price groups, lead time 30-40 working days.







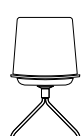





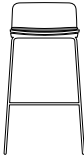

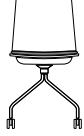
Profim COM



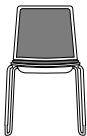

Paul Brooks

- Five types of bases allow any configuration
- The collection is completed with a barstool on a metal wire frame
- The square shape of the shell has four finishing options: plywood, with upholstered seat pad, with seat and backrest pad or fully upholstered
- The shell can come in different finishes: lacquered plywood, lined with natural veneer or HPL laminate which is scratch resistant

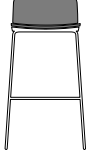
Item no	Base model +	Price Group (PG)	Price Group						Price
			0	①	②	③	④	⑤	
MCM120H000	Profim COM K12H <ul style="list-style-type: none"> • 4-legged • frame: black • plywood shell 								1441
MCM120V000	Profim COM K12V <ul style="list-style-type: none"> • cantilever • wire frame • frame: black • stackable • plywood shell 								1554
MCM120CV00	Profim COM K12CV <ul style="list-style-type: none"> • barstool • frame: black • plywood shell 								2171
MCM120HF00	Profim COM K12HF <ul style="list-style-type: none"> • "spider" frame • frame: black • plywood shell 								2648
MCM120HS00	Profim COM K12HS <ul style="list-style-type: none"> • "spider" frame • frame: black • swivel • plywood shell 								2947
MCM120HC00	Profim COM K12HC <ul style="list-style-type: none"> • "spider" frame • frame: black • on castors • plywood shell 								2994

Item no	Base model +	Price Group (PG)	Price Group						Price
			0	①	②	③	④	⑤	
MCM220H000	Profim COM K22H <ul style="list-style-type: none"> • 4-legged • frame: black • plywood shell • seat upholstered pad 		1816	1891	2080	2175	2269	2648	2837
MCM220V000	Profim COM K22V <ul style="list-style-type: none"> • cantilever • wire fame • frame: black • stackable • plywood shell • seat upholstered pad 		1923	2003	2205	2304	2403	2805	3005
MCM220CV00	Profim COM K22CV <ul style="list-style-type: none"> • barstool • frame: black • plywood shell • seat upholstered pad 		2516	2621	2883	3014	3145	3670	3933
MCM220HF00	Profim COM K22HF <ul style="list-style-type: none"> • "spider" frame • frame: black • plywood shell • seat upholstered pad 		2950	3072	3380	3534	3687	4302	4609
MCM220HS00	Profim COM K22HS <ul style="list-style-type: none"> • "spider" frame • frame: black • swivel • seat upholstered pad 		3237	3372	3680	3834	3986	4602	4909
MCM220HC00	Profim COM K22HC <ul style="list-style-type: none"> • "spider" frame • frame: black • on castors • seat upholstered pad 		3283	3420	3728	3880	4035	4648	4955
MCM320H000	Profim COM K32H <ul style="list-style-type: none"> • 4-legged • frame: black • plywood shell • seat and backrest upholstered pads 		2282	2377	2617	2733	2854	3330	3566

Item no	Base model +	Price Group (PG)	Price Group						Price
			0	①	②	③	④	⑤	
MCM320V000	Profim COM K32V <ul style="list-style-type: none"> • cantilever • wire frame • frame: black • stackable • plywood shell • seat and backrest upholstered pads 		2 391	2 491	2 738	2 863	2 987	3 486	3 734
MCM320HF00	Profim COM K32HF <ul style="list-style-type: none"> • "spider" frame • frame: black • plywood shell • seat and backrest upholstered pads 		3 373	3 513	3 865	4 041	4 217	4 920	5 273
MCM320HS00	Profim COM K32HS <ul style="list-style-type: none"> • "spider" frame • frame: black • swivel • seat and backrest upholstered pads 		3 662	3 814	4 165	4 340	4 516	5 219	5 571
MCM320HC00	Profim COM K32HC <ul style="list-style-type: none"> • "spider" frame • frame: black • on castors • seat and backrest upholstered pads 		3 706	3 860	4 212	4 388	4 565	5 266	5 619
MCM420H000	Profim COM K42H <ul style="list-style-type: none"> • 4-legged • frame: black • fully upholstered 		2 048	2 133	2 347	2 456	2 563	2 987	3 201
MCM420V000	Profim COM K42V <ul style="list-style-type: none"> • cantilever • wire frame • frame: black • stackable • fully upholstered 		2 156	2 245	2 472	2 583	2 696	3 145	3 370
MCM420CV00	Profim COM K42CV <ul style="list-style-type: none"> • barstool • frame: black • fully upholstered 		2 678	2 789	3 068	3 207	3 348	3 906	4 184

Item no	Base model +	Price Group (PG)	Price Group						Price
			0	①	②	③	④	⑤	
MCM420HF00	Profim COM K42HF • "spider" frame • frame: black • fully upholstered		3 161	3 293	3 624	3 787	3 952	4 611	4 941
MCM420HS00	Profim COM K42HS • "spider" frame • frame: black • swivel • fully upholstered		3 448	3 593	3 923	4 087	4 252	4 911	5 241
MCM420HC00	Profim COM K42HC • "spider" frame • frame: black • on castors • fully upholstered		3 495	3 640	3 970	4 133	4 299	4 957	5 288
MCM000CTH0	Profim COM CTH • Trolley for transportation								2 116
Accessories/Options/Surcharges:									
7TFRA018	Frame: V1 - cantilever with metal frame (Only for: K12V, K22V, K32V, K42V)								425
7TFRA019	Frame: V2 - reversed cantilever (Only for: K12V, K22V, K32V, K42V)								97
7COPR002	Frames colours: MetallicPro, White RAL 9016, Deep Green RAL 6004, Navy Blue RAL 5003, Burgundy RAL 3005, Salvia/Green RAL 6021, Blue RAL 5014, Terracota RAL 3012 (Only for: K12CV, K12H, K12HC, K12HF, K12HS, K12V, K22CV, K22H, K22HC, K22HF, K22HS, K22V, K32H, K32HC, K32HF, K32HS, K32V, K42CV, K42H, K42HC, K42HF, K42HS, K42V)								36
7COPR003	Frames colours: Lightgrey NCS S 2500-N; Grey NCS S 6500-N, Metalsilver, Steelgray (Only for: K12CV, K12H, K12HC, K12HF, K12HS, K12V, K22CV, K22H, K22HC, K22HF, K22HS, K22V, K32H, K32HC, K32HF, K32HS, K32V, K42CV, K42H, K42HC, K42HF, K42HS, K42V)								218
7COPR006	Frame colour: Gold (Only for: K12HC, K12HF, K12HS, K22HC, K22HF, K22HS, K32HC, K32HF, K32HS, K42HC, K42HF, K42HS)								522
7ARMR001	Armrests (Only for: K12H, K12V, K22CV, K22H, K22V, K32H, K32V, K42H, K42V)								524
7TARM003	Plywood pad for armrest (Only for: K12H, K12V, K22H, K22V, K32H, K32V, K42H, K42V)								231
	HPL LW01 (white), LW02 (black), LW03 (light gray)LW04 (grey), LW06 (dark blue), LW07 (light burgundy)(grey) (Only for: K12CV, K12H, K12HC, K12HF, K12HS, K12V, K22CV, K22H, K22HC, K22HF, K22HS, K22V, K32H, K32HC, K32HF, K32HS, K32V)								572
	Natural veneers Ash (NA), Beech (NB), Oak (NO), Walnut (NW) (Only for: K12CV, K12H, K12HC, K12HF, K12HS, K12V, K22CV, K22H, K22HC, K22HF, K22HS, K22V, K32H, K32HC, K32HF, K32HS, K32V)								377
	Natural colored veneers (ash): White (CNA01), Black (CNA02), Dark green (CNA05), Navy blue (CNA06), Burgundy (CNA07) (Only for: K12CV, K12H, K12HC, K12HF, K12HS, K12V, K22CV, K22H, K22HC, K22HF, K22HS, K22V, K32H, K32HC, K32HF, K32HS, K32V)								377

Accessories/Options/Surcharges:

7SEQU001	Quilting - pad or front side of the seat (Q1) (Only for: K22CV, K22H, K22HC, K22HF, K22HS, K22V, K32H, K32HC, K32HF, K32HS, K32V)	377
7BAQU001	Quilting - pad or front of the backrest (Q2) (Only for: K32H, K32HC, K32HF, K32HS, K32V)	377
7SHQU004	Quilting - front side of the shell (Q3) (Only for: K42CV, K42H, K42HC, K42HF, K42HS, K42V)	838
7JIRO001	Possibility of joining in rows (Only for: K12H, K12V, K22H, K22V, K32H, K32V, K42H, K42V)	316
7TATO002	Table top 2PB - extra charge: version with armrests (Only for: K12H, K22H, K32H, K42H)	802
7HAND002	Shell with cut-out (C) in upper part of the backrest, enabling moving the chair (Only for: K12H, K12HC, K12HF, K12HS, K12V, K22H, K22HC, K22HF, K22HS, K22V, K32H, K32HC, K32HF, K32HS, K32V)	36

0 price group: Evo

1 price group: Cura, Tonal, Xtreme

2 price group: Select

3 price group: Capture, Oceanic, Step, Synergy

4 price group: Steelcut 3, Steelcut Trio 3

6 price group: Paloma

Colours of plywood - standard colours of lacquer: H6, H12, H5

Natural veneers -Ash (NA), Beech (NB), Oak (NO), Wallnut (NW)

Coloured natural veneers - White Ash CNA01, Black Ash CNA02, Deep Green Ash CNA05 (RAL 6004), Navy Blue Ash CNA06 RAL 5003, Burgundy Ash CNA07 RAL 3005

HPL - White LW01 (RAL 9016), Light Grey LW03 (NCS S 2500-N), Grey LW04 (RAL 7037), Black LW02 (RAL 9011), Navy Blue LW06 (RAL 5003), Light Burgundy LW07 (RAL 3004)

Glides:

- standard - teflon glides (universal),

- option - felt glides (for hard floors).

When ordering please clearly indicate the chosen option.

Armrest pad: Version V1 - plastic pad, always black.

Version Com K12 / K22 / K32 colour and type of plywood pad is always the same as shell.

Versions Com K4 (fully upholstered) armrest plywood pad finishing:

- Colours of plywood - standard colours of lacquer: H6, H12, H5

- Natural veneers -Ash (NA), Beech (NB), Oak (NO), Wallnut (NW)

- Coloured natural veneers - White Ash CNA01, Black Ash CNA02, Deep Green Ash CNA05 (RAL 6004), Navy Blue Ash CNA06 RAL 5003, Burgundy Ash CNA07 RAL 3005

- HPL - White LW01 (RAL 9016), Light Grey LW03 (NCS S 2500-N), Grey LW04 (RAL 7037), Black LW02 (RAL 9011), Navy Blue LW06 (RAL 5003), Light Burgundy LW07 (RAL 3004)

Please clearly indicate the chosen option.

Armrests:

- 2P - metal, polypropylene pad (set) - does not apply to versions V and V2,

- 2P - metal, plywood pad (set) - does not apply to versions V , V1 and V2.

Quilting - extra charge to all price groups, lead time 30-40 working days.



Frame version: V2



Frame version: V1



Com

Paul Brooks

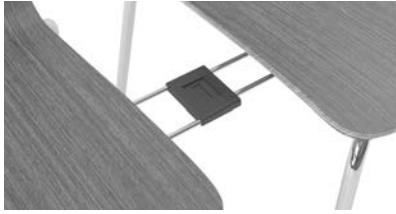

Joining in rows (H/V)

The linking part is an integral part of the chair, therefore it cannot be purchased and assembled at a later stage. The linking part is suitable for versions: H / H 2P / H 2PB / V.

Linking part is made of stainless steel and black plastic.

The total width of two connected chairs is:

- version H - 1160 mm,
- version H 2P/ H2PB - 1240-1310 mm,
- version V - 1170 mm.



Joining in rows (V1/V2)

The linking part is suitable for versions: V1 / V1 2P / V2. Always in black.

Total width of two connected chairs:

- version V1 - 985-1075 mm,
- version V1 2P - 1150-1220 mm,
- version V2 - 1165-1245 mm.



Trolley for transportation (CTH)

Trolley with a handle.

Available colours: black, metallic.

Always with soft castors.

Dimension: 1000 x 1010 x 630 mm



"Anti-panic" system (APA)*

"Anti-panic" connectors for chairs without armrests (refers only to the H versions).

Always in black.

Total width of two connected chairs: 1030 mm.



"Anti-panic" system (APB)*

"Anti-panic" connectors for chairs with armrests/ armrests with table top (refers only to the H versions).

Always in black.

Total width of two connected chairs: 1220-1290 mm.



"Anti-panic" system (APD)*

"Anti-panic" system for connecting rows (refers only to the H versions).

The price is for 1 connector.

Always in black.



Shell with cut-out (C)

Shell with cut-out in upper part of the backrest, enabling moving the chair. Do not concern versions with shell fully upholstered.



Table top (2PB)

The table top is an integral part of 2PB models therefore it cannot be purchased separately.







It is assembled on the right side of the chair and is equipped with anti-panic system which prevents blocking the table top in case of sudden movement. It's always black composite.

Maximum table load: 15kg.

Profim NOOR 4-LEG

StokkeAustad, Form Us With Love, Susanne Grønlund Design and Flokk design team

- Armrests available in matching colours to frame
- Stackable up to 10 chairs, 5 chairs with armrests (upholstered and unupholstered models)
- Table suspension for Profim Noor 6050/55 to Profim Eminent frame table available (See Eminent table)
- Red Dot Design award 2013
- Norwegian Design Council – Award for Design Excellence

Item no	Base model +	Price Group (PG)	Price Group						Price	
			0	①	②	③	④	⑤		⑥
6050	Profim NOOR 6050 • Polypropylene chair									1812
6055	Profim NOOR 6055 • 3D veneer chair • Oak									6200
6050s	Profim NOOR 6050S • Polypropylene chair • Seat upholstery		2027	2091	2134	2241	2304	2604	2946	
6050sb	Profim NOOR 6050sb • Polypropylene chair • Seat + back upholstery		2338	2412	2461	2584	2657	3002	3397	
6050f	Profim NOOR 6050f • Polypropylene chair • Fully upholstered in selected fabrics. See below Accessories/options for complete list		2765	2853	2910	3055	3143	3551		
6055s	Profim NOOR 6055s • 3D veneer chair • Oak • Seat upholstery		6194	6391	6520	6847	7043	7954	9001	

Item no	Base model +	Price Group (PG)	Price Group						Price
			0	①	②	③	④	⑤	
6055sb	Profim NOOR 6055sb • 3D veneer chair • Oak • Seat + back upholstery		6 507	6 710	6 848	7 190	7 363	8 355	9 451

Accessories/Options/Surcharges:

3YES	Linking device, welded. Must be specified at time of order. Can not be retrofitted.	91
PD303	Felt glides - 4 units.	62
AR809	Noor armrests pair (Only for: 6055, 6055s, 6055sb)	843
SH30006	Additional price* for dark stained oak 3D veneer shell (Only for: 6055, 6055s, 6055sb)	368

0 price group: Alba, Evo, Next,

1 price group: Cura, Tonal, Xtreme

2 price group: Select

3 price group: Capture, Oceanic, Step, Synergy

4 price group: Steelcut 3, Steelcut Trio 3

6-8 mm polypropylene (PP) and 6.7 mm 3D veneer shells (oak or dark stained oak*)

16x2 mm 4 leg tubular steel base

Weight: 5.7 kg model 6050, 4.7 kg model 6055

Seat height 439 mm, Back height 357 mm, Chair width 543 mm, Chair width w/armrests 550 mm, Chair height 835 mm, Chair depth 490 mm



S=Standard Collection - normal production time 10-15 working days. Applicable when all component options (fabric, shell, frame/legs) are standard (S).

E=Extended Collection - normal production time 20-30 working days. Applicable when any or all component options selected are extended (E).







For larger orders, please contact Customer Service for delivery details.



Profim NOOR SLEDGEBASE

StokkeAustad, Form Us With Love, Susanne Grønlund Design and Flokk design team

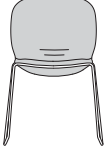
- Armrests available in matching colours to frame
- Stackable up to 10 chairs, 5 chairs with armrests (upholstered and unupholstered models)
- Table suspension for Profim Noor 6060/65 to Profim Eminent frame table available.
- Red Dot Design - 'Best of the best' award winner 2013
- Norwegian Design Council - Award for Design Excellence

Item no	Base model +	Price Group (PG)	Price Group						Price	
			0	①	②	③	④	⑤		⑥
6060	Profim NOOR 6060 • Polypropylene chair									2042
6065	Profim NOOR 6065 • 3D veneer chair • Oak									6427
6060s	Profim NOOR 6060s • Polypropylene chair • Seat upholstery		2 242	2 315	2 361	2 479	2 550	2 880	3 261	
6060sb	Profim NOOR 6060sb • Polypropylene chair • Seat + back upholstery		2 554	2 635	2 689	2 823	2 905	3 281	3 710	
6060f	Profim NOOR 6060f • Polypropylene chair • Fully upholstered in selected fabrics. See below Accessories/options for complete list		2 983	3 077	3 139	3 293	3 390	3 829		
6065s	Profim NOOR 6065s • 3D veneer chair • Oak • Seat upholstery		6 413	6 614	6 751	7 086	7 290	8 235	9 315	

Item no	Base model +	Price Group (PG)	Price Group						Price
			0	①	②	③	④	⑤	
6065sb	Profim NOOR 6065sb • 3D veneer chair • Oak • Seat + back upholstery		6 723	6 934	7 076	7 429	7 641	8 633	9 766

Accessories/Options/Surcharges:

3YES	Linking device, welded. Must be specified at time of order. Can not be retrofitted.	91
PD303	Felt glides - 4 units.	68
AR809	Noor armrests pair (Only for: 6065, 6065s, 6065sb)	843
SH30006	Additional price* for dark stained oak 3D veneer shell (Only for: 6065, 6065s, 6065sb)	368

0 price group: Alba, Evo, Next,

1 price group: Cura, Tonal, Xtreme

2 price group: Select

3 price group: Capture, Oceanic, Step, Synergy

4 price group: Steelcut 3, Steelcut Trio 3

6-8 mm polypropylene (PP) and 6.7 mm 3D veneer shells (oak or dark stained oak*) 12 mm steel sledgebase Weight: 6.5 kg model 6060, 6.2 kg model 6065
Seat height 439 mm, Back height 357 mm, Chair width 557 mm, Chair height 835 mm, Chair depth 525 mm

S=Standard Collection – normal production time 10-15 working days. Applicable when all component options (fabric, shell, frame/legs) are standard (S).

E=Extended Collection – normal production time 20-30 working days. Applicable when any or all component options selected are extended (E).

For larger orders, please contact Customer Service for delivery details.



Profim NOOR FOOTBASE

StokkeAustad, Form Us With Love, Susanne Grønlund Design and Flokk design team

- Standard gaslift B black
- Seat mechanism and footbase (Ø665 mm) in black painted aluminium as standard.
- Polished aluminium seat mechanism and footbase available as option. Seat mechanism, gaslift and footbase in white lacquered aluminium available as option
- Armrest available in black, white or metal silver
- Table suspension for Profim Noor 6070/75 to Profim Eminent frame table available.
- Red Dot Design Award 2013
- Norwegian Design Council – Award for Design Excellence

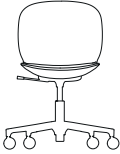
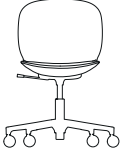
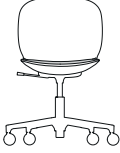
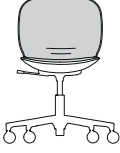
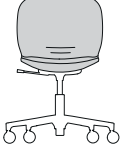
Item no	Base model +	Price Group (PG)	0	①	②	③	④	⑤	⑥	Price
6070	Profim NOOR 6070 • Polypropylene chair									2956
6075	Profim NOOR 6075 • 3D veneer chair • Oak									7343
6070s	Profim NOOR 6070s • Polypropylene chair • Seat upholstery		3 114	3 214	3 277	3 292	3 540	3 998	4 523	
6070sb	Profim NOOR 6070sb • Polypropylene chair • Seat + back upholstery		3 425	3 532	3 605	3 784	3 891	4 396	4 973	
6070f	Profim NOOR 6070f • Polypropylene chair • Fully upholstered in selected fabrics. See below Accessories/options for complete list		3 850	3 971	4 053	4 254	4 379	4 944		

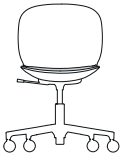
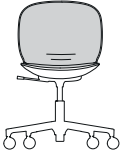
Item no	Base model +	Price Group (PG)	Price Group						Price
			0	①	②	③	④	⑤	
6075s	Profim NOOR 6075s • 3D veneer chair • Oak • Seat upholstery		7 280	7 511	7 663	8 047	8 277	9 347	10 576
6075sb	Profim NOOR 6075sb • 3D veneer chair • Oak • Seat + back upholstery		7 591	7 832	7 991	8 388	8 628	9 748	11 029

Accessories/Options/Surcharges:

125182	Glides, 58 mm	0
115000024009	Footbase in polished aluminium	579
AR809	Noor armrests pair (Only for: 6075, 6075s, 6075sb)	843
SH30006	Additional price* for dark stained oak 3D veneer shell (Only for: 6075, 6075s, 6075sb)	368

- 0 price group: Alba, Evo, Next,**
1 price group: Cura, Tonal, Xtreme
2 price group: Select
3 price group: Capture, Oceanic, Step, Synergy
4 price group: Steelcut 3, Steelcut Trio 3

6-8 mm polypropylene (PP) and 6.7 mm 3D veneer shells (oak or dark stained oak*)
 Weight: 8.0 kg model 6070, 7.6 kg model 6075
 Seat height 355-490 mm, back height 357 mm, chair width and depth 665 mm, chair height 727-857 mm



S=Standard Collection - normal production time 10-15 working days. Applicable when all component options (fabric, shell, frame/legs) are standard (S).
 E=Extended Collection - normal production time 20-30 working days. Applicable when any or all component options selected are extended (E).







For larger orders, please contact Customer Service for delivery details.



Profim NOOR WOODEN LEGS

StokkeAustad, Form Us With Love, Susanne Grønlund Design and Flokk design team

- Seat frame in black painted aluminium as standard.
- Wooden legs: natural stained ash as standard.
- Not stackable
- Red Dot Design Award 2013
- Norwegian Design Council – Award for Design Excellence

Item no	Base model +	Price Group (PG)	Price Group						Price	
			0	①	②	③	④	⑤		⑥
6080	Profim NOOR 6080 • Polypropylene chair									4574
6085	Profim NOOR 6085 • 3D veneer chair • Oak									8963
6080s	Profim NOOR 6080s • Polypropylene chair • Seat upholstery		4651	4801	4897	5143	5290	5973	6757	
6080sb	Profim NOOR 6080sb • Polypropylene chair • Seat + back upholstery		4965	5119	5226	5484	5643	6374	7209	
6080f	Profim NOOR 6080f • Polypropylene chair • Fully upholstered in selected fabrics. See below Accessories/options for complete list		5392	5560	5675	5959	6131	6925		
6085s	Profim NOOR 6085s • 3D veneer chair • Oak • Seat upholstery		8821	9098	9285	9749	10028	11329	12812	

Item no	Base model +	Price Group (PG)	Price Group						Price
			0	①	②	③	④	⑤	
6085sb	Profim NOOR 6085sb • 3D veneer chair • Oak • Seat + back upholstery		9 130	9 419	9 610	10 093	10 379	11 726	13 263

Accessories/Options/Surcharges:

PD303	Felt glides - 4 units.	68
SH30006	Additional price* for dark stained oak 3D veneer shell (Only for: 6085, 6085s, 6085sb)	368

0 price group: Alba, Evo, Next,

1 price group: Cura, Tonal, Xtreme

2 price group: Select

3 price group: Capture, Oceanic, Step, Synergy

4 price group: Steelcut 3, Steelcut Trio 3

6-8 mm polypropylene (PP) and 6.7 mm 3D veneer shells (oak or dark stained oak*)

Weight: 5.4 kg model 6080, 4.6 kg model 6085

Seat height 439 mm, Back height 357 mm, Chair width 490 mm, Chair height 832 mm, Chair depth 480 mm



S=Standard Collection – normal production time 10-15 working days. Applicable when all component options (fabric, shell, frame/legs) are standard (S).

E=Extended Collection – normal production time 20-30 working days. Applicable when any or all component options selected are extended (E).







For larger orders, please contact Customer Service for delivery details.



Profim NOOR UP

StokkeAustad, based on the design of the RBM Noor of StokkeAustad, Form Us With Love, Susanne Grønlund Design and Flokk design team

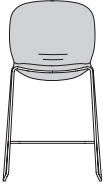
- Suitable for tables around 90 cm high
- Armrests available in matching colours to frame
- Stackable up to 5 chairs

Item no	Base model +	Price Group (PG)	Price Group						Price	
			0	①	②	③	④	⑤		⑥
6090	Profim NOOR UP 6090 • Polypropylene chair									2771
6095	Profim NOOR UP 6095 • 3D veneer chair • Oak									7159
6090s	Profim NOOR UP 6090s • Polypropylene chair • Seat upholstery		2940	3033	3094	3247	3340	3773	4269	
6090sb	Profim NOOR UP 6090sb • Polypropylene chair • Seat + back upholstery		3249	3351	3420	3591	3695	4172	4718	
6090f	Profim NOOR UP 6090f • Polypropylene chair • Fully upholstered in selected fabrics. See below Accessories/options for complete list		3675	3792	3869	4063	4180	4719		
6095s	Profim NOOR UP 6095s • 3D veneer chair • Oak • Seat upholstery		7108	7334	7482	7856	8079	9127	10323	

Item no	Base model +	Price Group (PG)	Price Group						Price
			0	①	②	③	④	⑤	
6095sb	Profim NOOR UP 6095sb • 3D veneer chair • Oak • Seat + back upholstery		7 417	7 653	7 807	8 197	8 432	9 524	10 773

Accessories/Options/Surcharges:

PD303	Felt glides - 4 units.	68
SH30006	Additional price* for dark stained oak 3D veneer shell (Only for: 6095, 6095s, 6095sb)	379

0 price group: Alba, Evo, Next,

1 price group: Cura, Tonal, Xtreme

2 price group: Select

3 price group: Capture, Oceanic, Step, Synergy

4 price group: Steelcut 3, Steelcut Trio 3

6-8 mm polypropylene (PP) and 6.7 mm 3D veneer shells (oak or dark stained oak*)

Weight: 7.7 kg model 6090, 7.2 kg model 6095

12 mm medium-high steel sledgebase

Seat height 630 mm, Back height 357 mm, Chair width 565 mm, Chair height 1025 mm, Chair depth 548 mm



S=Standard Collection – normal production time 10-15 working days. Applicable when all component options (fabric, shell, frame/legs) are standard (S).

E=Extended Collection – normal production time 20-30 working days. Applicable when any or all component options selected are extended (E).



For larger orders, please contact Customer Service for delivery details.



Profim NORMO

Studio Ganszyniec

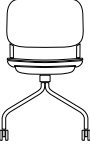
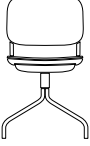
- Chair designed for work and meetings
 - Solid metal construction guarantees stability regardless of intensity of use
 - Our first circular product
 - Manufactured without the use of glue or staples for easy disassembly
 - The seat structure is created from 100% recycled plastic (PP)
 - Normo can be separated/disassembled and recycled up to 94%

Item no	Base model +	Price Group (PG)	Price Group						Price
			0	①	②	③	④	⑤	
MKN500H000	Profim NORMO 500H • 4 legged • seat and backrest upholstered		2 540	2 820	3 233	3 367	3 755	3 755	4 327
MKN500HC00	Profim NORMO 500HC • spider' frame on castors • seat and backrest upholstered		3 512	3 792	4 205	4 363	4 728	4 874	5 627
MKN500HS00	Profim NORMO 500HS • spider' frame on glides • swivel • seat and backrest upholstered		3 780	4 047	4 461	4 643	4 971	5 190	5 968
MKN500V000	Profim NORMO 500V • cantilever • seat and backrest upholstered		2 625	2 905	3 318	3 452	3 829	3 841	4 449

Accessories/Options/Surcharges:

7ARMR020	SP - metal armrests, short	377
7ARMR021	LP - metal armrests, long	438

0 price group: Evo

1 price group: Cura, Tonal, Xtreme

2 price group: Select

3 price group: Capture, Oceanic, Step, Synergy

4 price group: Steelcut 3, Steelcut Trio 3

Frames colours:

- Black RAL 9005
- MetallicPro
- White RAL 9016

- Lightgrey NCS S 2500-N
- Grey NCS S 6500-N
- Deep green RAL 6004
- Navy blue RAL 5003
- Burgundy RAL 3005
- Salvia/Green RAL 6021
- Blue RAL 5014
- Terracota RAL 3012

Glides:

- teflon glides (universal),
- felt glides (for hard floors).

Castors in HC model:

- universal.

When ordering please clearly indicate the chosen option.



Armrest SP





Armrest LP



Profim ZOO

Paul Brooks

- Variety of configurations
- Available in different versions: on four legs, legs with castors, with plastic or upholstered seat, plastic or upholstered backrest, with or without armrests
- Available in three plastic colours (black, grey and light grey) and five frame colours

Item no	Base model +	Price Group (PG)	0	①	②	③	④	⑤	Price
MZO522H000	Profim ZOO 522H • 4-legged • frame: black • plastic seat and backrest								2 139
MZO502H000	Profim ZOO 502H • 4-legged • frame: black • upholstered seat • plastic backrest		2 406	2 625	2 795	2 905	3 428	3 233	
MZO500H000	Profim ZOO 500H • 4-legged • frame: black • upholstered seat and backrest		3 464	3 902	4 363	4 545	5 384	5 069	

Accessories/Options/Surcharges:

7TFRA005	Frame HC - 4-legged version with castors	608
7CFRA051	Frame: MetallicPro	36
7ARMR001	Armrests	461
7TATO002	Table top	838
7JIRO001	Possibility of joining in rows	329

0 price group: Evo

1 price group: Cura, Tonal, Xtreme

2 price group: Select

3 price group: Capture, Oceanic, Step, Synergy

4 price group: Steelcut 3, Steelcut Trio 3

Glides:

- standard - teflon glides (universal),
- option - felt glides (for hard floors).

Castors in HC models:

- universal castors

When ordering please clearly indicate the chosen option.

Plastic colours for seats, backrests and armrests:

black (RAL 9005), grey (NCS S 6500-N), lightgrey (NCS S 2500-N).

It is possible to freely join the colours of seat, backrest and armrests.

Although in one RAL/NCS, the colour of individual elements of the chair such as seat, backrest, armrests and frame, can vary due to different types of materials used.

Seat cover:

- black frame - cover always black (RAL 9005),
- MetallicPro, RAL/NCS - cover always grey (NCS S 6500-N), except of chairs with black plastic seat - in that case cover is always black (RAL 9005).

In model Zoo 500 without armrests the plastic elements

connecting the frame with backrest are:

- black frame - always black (RAL 9005),
- MetallicPro frame - always grey (NCS S 6500-N),
- grey / lightgrey frame - always in frame colour.



Frame version: HC



Zoo

Paul Brooks



Table top (2PB)

The table top is an integral part of 2PB models therefore it cannot be purchased separately. It is assembled on the right side of the chair and is equipped with anti-panic system which prevents blocking the table top in case of sudden movement. It's always black composite. Maximum table load: 15 kg.

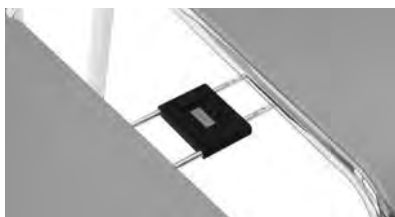

Joining in rows - 4-legged version

The linking part is an integral part of the chair, therefore it cannot be purchased and assembled at a later stage. The linking part is suitable for versions on 4 legs (H/H 2P/H 2PB). Linking part is made of stainless steel and black plastic. The total width of two connected chairs is:
- no armrests - 1070 mm,
- with armrests - 1260 mm.



„Anti-panic” system (APA)*

"Anti-panic" connectors for chairs without armrests. Available colours: black, metallic. Total width of two connected chairs: 1120 mm. The anti-panic system meets EN 14703 norm.



„Anti-panic” system (APB)*

"Anti-panic" connectors for chairs with armrests. Always in black. Total width of two connected chairs: 1170 mm. The anti-panic system meets EN 14703 norm.



„Anti-panic” system (APC)*

"Anti-panic" connectors for chairs with armrests and a table top. Always in black. Total width of two connected chairs: 1350 mm. The anti-panic system meets EN 14703 norm.



„Anti-panic” system (APD)*

"Anti-panic" system for connecting rows. The price is for 1 connector. Always in black. The anti-panic system meets EN 14703 norm.



Trolley for transportation (CTH)

Trolley with a handle. Available colours: black, metallic. Always with soft castors. Dimensions: 1000 x 1000 x 600 mm

Sofas





Armchairs

Modular systems

Profim CHIC

Christophe Pillet

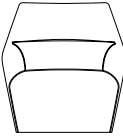
- The seat is equipped with the return memory (it returns to the starting position by itself)
- Restaurant and bar chairs with a range of bases and armchairs with a swivel base or with glides
- Möbelfakta certificate - a guarantee of durability, safety, environmental care and social responsibility during the production process

Item no	Base model +	Price Group (PG)	Price Group						Price
			0	①	②	③	④	⑤	
MCC210H000	Profim CHIC 21H • chair • metal legs • frame: MetallicPro; Black RAL 9005; White RAL 9016; Deep Green RAL 6004; Navy Blue RAL 5003; Burgundy RAL 3005; Salvia/Green RAL 6021, Blue RAL 5014; Terracota RAL 3012 • without armrests		4 242	4 419	4 860	5 082	5 303	6 186	6 627
MCC200H000	Profim CHIC 20H • chair • metal legs • frame: MetallicPro; Black RAL 9005; White RAL 9016; Deep Green RAL 6004; Navy Blue RAL 5003; Burgundy RAL 3005; Salvia/Green RAL 6021, Blue RAL 5014; Terracota RAL 3012 • with armrests		4 636	4 830	5 313	5 555	5 797	6 763	7 246
MCC200F000	Profim CHIC 20F • chair • base: polished aluminium • 4-star base		5 337	5 560	6 116	6 395	6 673	7 785	8 340
MCC100FU00	Profim CHIC 10FU • armchair		6 777	7 060	7 765	8 117	8 470	9 881	10 587
MCC210CH00	Profim CHIC 21CH • bar stool without armrests • metal legs • frame: MetallicPro; Black RAL 9005; White RAL 9016; Deep Green RAL 6004; Navy Blue RAL 5003; Burgundy RAL 3005; Salvia/Green RAL 6021, Blue RAL 5014; Terracota RAL 3012		4 962	5 169	5 685	5 942	6 202	7 234	7 751
MCC200CH00	Profim CHIC 20CH • bar stool • metal legs • frame: MetallicPro; Black RAL 9005; White RAL 9016; Deep Green RAL 6004; Navy Blue RAL 5003; Burgundy RAL 3005; Salvia/Green RAL 6021, Blue RAL 5014; Terracota RAL 3012		5 355	5 578	6 138	6 416	6 694	7 812	8 369

Accessories/Options/Surcharges:

7TFRA011	Frame: HW - wooden legs beech wood - H5, H6, H7, H8, H11, H12 (HW) (Only for: 20H, 21H)	2670
7TGAS003	Gas lift with memory (Only for: 20F)	802
7TFRA022	Gas lift with memory without height adjustment (Only for: 10FU)	1957
7COPR003	Frames colours: Lightgrey NCS S 2500-N; Grey NCS S 6500-N , Metalsilver, Steelgray (Only for: 20CH, 20H, 21CH, 21H)	218
7COPR006	Frame colour: Gold (Only for: 20H, 21H)	425

0 price group: Evo

1 price group: Cura, Tonal, Xtreme

2 price group: Select

3 price group: Capture, Oceanic, Step, Synergy

4 price group: Steelcut 3, Steelcut Trio 3

6 price group: Paloma

Glides:

- standard - teflon glides (universal),

- option - felt glides (for hard floors).

When ordering please clearly indicate the chosen option.







Frame version: HW

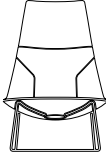
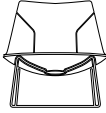
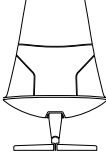

Profim CHIC LOUNGE

Christophe Pillet

- Characteristic detail in the form of vertical stitching
- Two backrest levels – for different needs and different users
- Possibility to combine leather and fabric in one cover
- Possibility to choose different upholstery colours
- Cushion and footrest increase the comfort of rest
- Attractive price/quality ratio
- Möbelfakta certificate - a guarantee of durability, safety, environmental care and social responsibility during the production process

Item no	Base model +	Price Group (PG)	①	②	③	④	⑤	⑥	Price
MCLA10V300	Profim CHIC LOUNGE A10V3 • armchair • high backrest • wire frame • frame: MetallicPro; Black RAL 9005; White RAL 9016; Deep Green RAL 6004; Navy Blue RAL 5003; Burgundy RAL 3005; Salvia/Green RAL 6021, Blue RAL 5014; Terracota RAL 3012		8 518	9 370	9 796	10 223	11 925	16 043	
MCLA20V300	Profim CHIC LOUNGE A20V3 • armchair • low backrest • wire frame • frame: MetallicPro; Black RAL 9005; White RAL 9016; Deep Green RAL 6004; Navy Blue RAL 5003; Burgundy RAL 3005; Salvia/Green RAL 6021, Blue RAL 5014; Terracota RAL 3012		7 659	8 422	8 808	9 189	10 720	13 952	
MCLA10F000	Profim CHIC LOUNGE A10F • armchair • high backrest • 4-star base • frame: MetallicPro; Black RAL 9005; White RAL 9016; Deep Green RAL 6004; Navy Blue RAL 5003; Burgundy RAL 3005; Salvia/Green RAL 6021, Blue RAL 5014; Terracota RAL 3012		10 990	12 087	12 640	13 188	15 387	18 985	
MCLA20F000	Profim CHIC LOUNGE A20F • armchair • low backrest • 4-star base • frame: MetallicPro; Black RAL 9005; White RAL 9016; Deep Green RAL 6004; Navy Blue RAL 5003; Burgundy RAL 3005; Salvia/Green RAL 6021, Blue RAL 5014; Terracota RAL 3012		10 129	11 142	11 646	12 154	14 180	16 833	
MCLPV30000	Profim CHIC LOUNGE PV3 • footrest • wire frame • frame: MetallicPro; Black RAL 9005; White RAL 9016; Deep Green RAL 6004; Navy Blue RAL 5003; Burgundy RAL 3005; Salvia/Green RAL 6021, Blue RAL 5014; Terracota RAL 3012		4 661	5 127	5 362	5 594	6 526	8 350	
MCLCU00000	Profim CHIC LOUNGE CU • high backrest cushion		786	866	903	943	1 102	1 750	

Accessories/Options/Surcharges:

7COPR003	Frames colours: Lightgrey NCS S 2500-N; Grey NCS S 6500-N , Metalsilver, Steelgray (Only for: A10F, A10V3, A20F, A20V3, PV3)	218
7COPR006	Frame colour: Gold (Only for: A10F, A20F)	742
7COPR006	Frame colour: Gold (Only for: A10V3, A20V3, PV3)	522

1 price group: Cura, Tonal, Xtreme

2 price group: Select

3 price group: Capture, Oceanic, Step, Synergy

4 price group: Steelcut 3, Steelcut Trio 3

6 price group: Paloma

Glides:

- standard - teflon glides (universal),
- option - felt glides (for hard floors).

When ordering please clearly indicate the chosen option.

Option of mixing colours of the same fabric according to below scheme:

A - inner part of shell colour, B - outer part of shell colour.

In case of order of such option, following example should be specified: SC-67097/SC-60132 (where SC-67097 - A, SC-60132 - B).

Option is available at no extra charge.





In models A10V3/A10F it is possible to order extra cushion for the backrest.

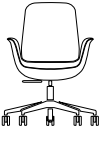

Profim ELLIE PRO

ITO Design

- Quick and easy adjustment with the synchro self mechanism (height and tilt adjustment).
- Mechanism fully integrated into the seat
- Possibility of choosing two-colour upholstery
- Several types and colours of bases (four- and five-star bases and metal wire frame or version with wooden legs)
- Blue Angel certificate - confirms that our chair is environmentally friendly

Item no	Base model +	Price Group (PG)	0	①	②	③	④	⑤	Price
MHB100ST00	Profim ELLIE PRO 10ST <ul style="list-style-type: none"> • swivel armchair • Self mechanism • high backrest • 5-star base • base: black 		7 410	7 719	8 490	8 876	9 263	10 805	
MHB200ST00	Profim ELLIE PRO 20ST swivel armchair Self mechanism low backrest 5-star base base: black		7 121	7 418	8 160	8 530	8 901	10 163	
MHB100HS00	Profim ELLIE PRO 10HST <ul style="list-style-type: none"> • swivel armchair • Self mechanism • high backrest • high 4-star base • base: black / MetallicPro / white / polished aluminum 		7 963	8 295	9 123	9 537	9 952	11 611	
MHB200HS00	Profim ELLIE PRO 20 HST <ul style="list-style-type: none"> • swivel armchair • Self mechanism • low backrest • high 4-star base • base: black / MetallicPro / white / polished aluminum 		7 675	7 994	8 793	9 194	9 591	11 192	
MHB100V000	Profim ELLIE PRO 10V3 <ul style="list-style-type: none"> • swivel armchair • Self mechanism • high backrest • wire frame • frame: black / MetallicPro / white 		8 339	8 686	9 556	9 991	10 424	12 161	
MHB200V000	Profim ELLIE PRO 20V3 <ul style="list-style-type: none"> • swivel armchair • Self mechanism • low backrest • wire frame • frame: black / MetallicPro / white 		8 052	8 387	9 227	9 644	10 065	11 743	

Item no	Base model +	Price Group (PG)	0	①	②	③	④	⑤	Price
MHB100HW00	Profim ELLIE PRO 10HW <ul style="list-style-type: none"> • swivel armchair • Self mechanism • high backrest • wooden legs • frame: beech wood - H5, H6, H12 		10 586	11 027	12 130	12 681	13 232	15 437	

MHB200HW00	Profim ELLIE PRO 20HW <ul style="list-style-type: none"> • swivel armchair • Self mechanism • low backrest • wooden legs • frame: beech wood - H5, H6, H12 		10 299	10 728	11 800	12 337	12 872	15 017	
------------	--	---	--------	--------	--------	--------	--------	--------	--

Accessories/Options/Surcharges:

7BASC008	Light Gray (Only for: 10ST, 20ST)	109
7TARM006	Upholstered armpad - leather pad on the armrests	218
7COPR003	Frames colours: Lightgrey NCS S 2500-N; Grey NCS S 6500-N (Only for: 10V3, 20V3)	218
7CFRA025	Frame : metalsilver (Only for: 10V3, 20V3)	243
7COPR006	Frame colour: Gold (Only for: 10V3, 20V3)	717

0 price group: Evo

1 price group: Cura, Tonal, Xtreme

2 price group: Select

3 price group: Capture, Oceanic, Step, Synergy

4 price group: Steelcut 3, Steelcut Trio 3

Castors / glides:

Standard:

- hard castors - for soft floors.

Option:

- soft castors - for hard floors,

- teflon glides - universal,

- felt glides - for hard floors.

When ordering please clearly indicate the chosen option.

In case of armrests with a leather pad, the threads will always be the same as the upholstery inside the shell.

In models HST, V3, HW Self mechanism is not height adjustable.

Option of mixing colours of the same fabric according to below scheme:

A - inner part of shell colour, B - outer part of shell colour.







In case of order of such option, following example should be specified: SC-67097/SC-60132 (where SC-67097 - A, SC-60132 - B). Option is available at no extra charge.



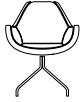

Profim FAN

Piotr Kuchciński

- Several types of bases - glides and castors as well as wooden legs which perfectly match the SW40 and Revo tables
- Additional cushion improves comfort of use
- The collection also includes a cantilever sofa
- Two types of thread to choose from (upholstery colour or decorative thread)
- Möbelfakta certificate - a guarantee of durability, safety, environmental care and social responsibility during the production process

Item no	Base model +	Price Group (PG)	Price Group						Price
			0	①	②	③	④	⑤	
MFN100H000	Profim FAN 10H • armchair • 4-legged • frame: black		3 829	3 988	4 586	4 984	5 384	5 981	6 380
MFN100V000	Profim FAN 10V • armchair • cantilever • frame: black		4 080	4 250	4 889	5 312	5 737	6 376	6 799
MFN200V000	Profim FAN 20V • 2-seat sofa • cantilever • frame: black		6 150	7 122	8 472	8 812	11 303	9 832	13 345
MFN100R000	Profim FAN 10R • swivel armchair • round base • Gas lift with memory • base: MetallicPro, Black RAL 9005, White RAL 9016, Deep Green RAL 6004, Navy Blue RAL 5003, Burgundy RAL 3005, Salvia/Green RAL 6021, Blue RAL 5014, Terracota RAL 3012		5 591	6 272	6 892	7 171	8 569	8 058	10 075
MFN100F000	Profim FAN 10F • swivel armchair • 4-star base • base: polished aluminum		6 102	6 733	7 353	7 645	9 030	8 569	10 538
MFN100Z000	Profim FAN 10Z • swivel armchair • Rocker mechanism • base: black		4 509	5 141	5 761	5 992	7 353	6 892	8 824

Item no	Base model +	Price Group (PG)	Price Group						Price
			0	①	②	③	④	⑤	
MFN100E000	Profim FAN 10E swivel armchair Economic mechanism base: black		4 072	4 704	5 335	5 542	6 940	6 466	8 422

MFN1000000	Profim FAN CU • seat cushion for FAN 10 version		556	580	674	956	1 162	1 236	1 310
------------	--	---	-----	-----	-----	-----	-------	-------	-------

Accessories/Options/Surcharges:

7TFRA010	Frame: HS - swivel version on glides (Only for: 10H)	374
7TFRA009	Frame: HC - version with castors (Only for: 10H)	447
7TFRA011	Frame: HW - wooden legs - beech wood: H5, H6, H12 (Only for: 10H)	1 661
7COPR002	Frames colours: MetallicPro, White RAL 9016, Deep Green RAL 6004, Navy Blue RAL 5003, Burgundy RAL 3005, Salvia/Green RAL 6021, Blue RAL 5014, Terracota RAL 3012 (Only for: 10H, 10V)	36
7COPR002	Frames colours: MetallicPro, White RAL 9016, Deep Green RAL 6004, Navy Blue RAL 5003, Burgundy RAL 3005, Salvia/Green RAL 6021, Blue RAL 5014, Terracota RAL 3012 (Only for: 20V)	61
7COPR006	Frame colour: Gold (Only for: 10H, 10V)	522
7COPR006	Frame colour: Gold (Only for: 20V)	1 033
7COPR003	Frames colours: Lightgrey NCS S 2500-N; Grey NCS S 6500-N, Metalsilver, Steelgray (Only for: 10H, 10R, 10V, 20V)	218
7BASC027	Base: MetallicPro (Only for: 10E, 10Z)	377
7BASC003	Base: polished aluminum (Only for: 10Z, 10E)	802
7CPLY010	Oak wood - HO6, HO12, HO11 (Only for: 10H)	329
7TGAS003	Gas lift with memory (Only for: 10F)	838

0 price group: Evo

1 price group: Cura, Tonal, Xtreme

2 price group: Select

3 price group: Capture, Oceanic, Step, Synergy

4 price group: Steelcut 3, Steelcut Trio 3

6 price group: Paloma

Castors / glides

Standard:

- universal castors (models 10Z/10E/10HC),
- teflon glides - universal (models 10F/10H/10HS/10HW),
- hard glides - for soft floors (models 10V/20V).

Option:

- teflon glides - universal (10Z/10E),
- felt glides - for hard floors (10H/10HS/10HW/10V/20V/10F),
- felt pads under the base - for hard floors (model 10R).

When ordering please clearly indicate the chosen option.

Model 10HW: wooden legs: beech wood - H5, H6, H12,

Two options of threads:

- upholstery matching threads
 - decorative threads:
 - black upholstery - threads always white,
 - all other colours of upholstery - threads always black.
- Option is available at no extra charge.



Frame version: 10HC







Frame version: 10HW



Profim NU

Paul Brooks

- The inner and outer sections of the shell may have different coloured fabrics
- The shell is mounted on several types of bases
- The cushion will increase the comfort of rest
- Möbelfakta certificate - a guarantee of durability, safety, environmental care and social responsibility during the production process

Item no	Base model +	Price Group (PG)	Price Group						Price
			0	①	②	③	④	⑤	
MNU200H000	Profim NU 20H • armchair • swivel • 4-legged • frame: black		4 962	5 169	5 685	5 942	6 202	7 234	11 863
MNU200V000	Profim NU 20V3 • armchair • wire frame • frame: black		4 854	5 056	5 560	5 812	6 067	7 077	11 619
MNU200R000	Profim NU 20R • swivel armchair • round base • base: MetallicPro, White RAL 9016, Deep Green RAL 6004, Navy Blue RAL 5003, Burgundy RAL 3005, Salvia/Green RAL 6021, Blue RAL 5014, Terracota RAL 3012		7 001	7 632	8 350	8 678	10 878	12 615	14 451
MNU200F000	Profim NU 20F • swivel armchair • 4-star base • base: polished aluminum		6 507	6 777	7 455	7 794	8 132	9 488	15 193

Accessories/Options/Surcharges:

7TFRA009	Frame: HC - version with castors - white / graphite / polished aluminum (Only for: 20H)	624
7TFRA011	Frame: HW - wooden legs - beech wood: H5, H6, H7, H8, H11, H12, H13 (Only for: 20H)	1 141
7COPR002	Frames colours: MetallicPro, White RAL 9016, Deep Green RAL 6004, Navy Blue RAL 5003, Burgundy RAL 3005, Salvia/Green RAL 6021, Blue RAL 5014, Terracota RAL 3012 (Only for: 20H, 20V3)	48
7COPR003	Frames colours: Lightgrey NCS S 2500-N; Grey NCS S 6500-N, Metalsilver, Steelgray (Only for: 20H, 20R, 20V3)	218
7COPR006	Frame colour: Gold (Only for: 20H, 20V3)	522
7SHQU006	Quilting - front side of the seat (Q5)	499
7TGAS003	Gas lift with memory (Only for: 20F, 20R)	838

0 price group: Evo

1 price group: Cura, Tonal, Xtreme

2 price group: Select

3 price group: Capture, Oceanic, Step, Synergy

4 price group: Steelcut 3, Steelcut Trio 3

Glides

Standard:

- teflon glides – universal (models 20HS/20HW/20V3/20F).

Option:

- hard castors - for soft floors (model 20H/20HC),

- soft castors - for hard floors (model 20H/20HC),

- teflon glides – universal (models 20H/20HS, 20HW),

- felt glides - for hard floors

When ordering please clearly indicate the chosen option.

Model 20HW: wooden legs: beech wood - H5, H6, H12.

Option of mixing colours of the same fabric according to below scheme:

A - cushion, B - inner part of the shell, C - outer part of the shell.

In case of order of such option, following example should be specified: SC-67097/SC-60132/SC-60999 (where SC-67097 - A, SC-60132 - B, SC-60999 - C).

Option is available at no extra charge.

Quilting - extra charge to all price groups, lead time 30-40 working days.



Frame version: 20HC



Frame version: 20HW







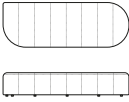

Profim REVO

Pearson Lloyd

- Represents a radical rethinking of the way office furniture is made.
- Created from recycled and infinitely recyclable REPP, instead of plywood
- Includes sofas, benches, screens, stools and tables in softly contoured, organic shapes
- With 96 configurations can be customised to suit every workspace, whatever its function or size
- The weight of the product is reduced by 40% lowering the carbon footprint during production and transportation by 13% and 40% respectively.
- Manufactured without the use of glue or staples for easy disassembly

Item no	Base model +	Price Group (PG)	Price Group						Price
			0	①	②	③	④	⑤	
MRVP400000	Profim REVO P40 • Pouffe, • Ø 40 cm	 	5 000	5 208	5 734	6 020	6 261	7 325	9 920
MRVP600000	Profim REVO P60 • Pouffe, • Ø 60 cm	 	6 053	6 306	7 084	7 439	7 736	9 051	14 050
MRVSN15000	Profim REVO SN150 • Seat narrow, • lenght 150 cm	 	11 767	12 257	13 150	13 807	14 359	16 800	22 750
MRVSN21000	Profim REVO SN210 • Seat narrow, • lenght 210 cm	 	15 063	15 690	16 881	17 724	18 434	21 567	33 484
MRVSW12000	Profim REVO SW120 • Seat wide, • lenght 120 cm	 	12 459	12 978	13 847	14 541	15 121	17 692	23 956
MRVSW18000	Profim REVO SW180 • Seat wide, • lenght 180 cm	 	16 590	17 281	18 426	19 346	20 121	23 542	31 876

Item no	Base model +	Price Group (PG)	Price Group						Price
			0	①	②	③	④	⑤	
MRVSW24000	Profim REVO SW240 • Seat wide, • lenght 240 cm		20 589	21 447	22 866	24 009	24 969	29 215	39 558
MRVB900000	Profim REVO B90 • Backrest, • lenght 90 cm		4 483	4 669	5 092	5 348	5 561	6 507	8 810
MRVB120000	Profim REVO B120 • Backrest, • lenght 120 cm		5 361	5 585	6 100	6 405	6 661	7 793	10 552
MRVB180000	Profim REVO B180 • Backrest, • lenght 180 cm		7 614	7 931	8 686	9 121	9 485	11 098	15 027
MRVW900000	Profim REVO W90 • Screen, • wide 90 cm		6 460	6 729	7 702	8 088	8 411	9 841	13 325
MRVW120000	Profim REVO W120 • Screen, • wide 120 cm		8 196	8 538	9 830	10 323	10 736	12 560	17 006
MRVW180000	Profim REVO W180 • Screen, • wide 180 cm		10 964	11 422	13 401	14 015	14 625	17 063	23 184

Accessories/Options/Surcharges:

7ELEC004	Mediaport - electrical outlet 230V and 2 USB ports (Only for: P60, SN150, SN210, SW120, SW180, SW240)	2 735
7TFOA003	Flame retardant foam BS 5852 (Only for: B120, B180, B90, P40, P60, SN150, SN210, SW120, SW180, SW240)	831

0 price group: Evo

1 price group: Cura, Tonal, Xtreme

2 price group: Select

3 price group: Capture, Oceanic, Step, Synergy

4 price group: Steelcut 3, Steelcut Trio 3

For Valencia and Silvertex (extended) fabrics - no quilting on the seat modules

Individual modules allow to create various types of systems / sets depending on your needs. A full list of possible configurations is available through the configurator on the website www.proffim.eu or directly at the link: [CONFIGURATOR pCon](#).

The price for a configured set is the amount of the value of each module of a given set.

Possibility to freely choose the type of upholstery for individual elements within a given set (e.g. seat: Select, backrest: Synergy, screen: Sprint).

The screens can only be combined with wide seats: SW120, SW160 or SW240.

It is not possible to purchase the screen as a free-standing module.



Profim SORRISO

Jarosław Szymański, Studio 1:1

- Three base options: cantilever, four-star base or flat base
- Möbelfakta certificate - a guarantee of durability, safety, environmental care and social responsibility during the production process

Item no	Base model +	Price Group (PG)	Price Group						Price
			0	①	②	③	④	⑤	
MSY100V000	Profim SORRISO 10V • armchair • wire frame • frame: black		5 494	6 089	7 171	7 450	9 736	8 872	11 729

Accessories/Options/Surcharges:

7SHQU006	Quilting - front side of the seat (Q5)	511
7CFRA051	Frame: MetallicPro	36

0 price group: Evo

1 price group: Cura, Tonal, Xtreme

2 price group: Select

3 price group: Capture, Oceanic, Step, Synergy

4 price group: Steelcut 3, Steelcut Trio 3

6 price group: Paloma

Castors / glides

Standard:

- teflon glides - universal

Option:

- felt glides - for hard floors

When ordering please clearly indicate the chosen option.

Option of mixing colours of the same fabric on shell and cushion according to below scheme:

A - cushion colour, B - shell colour.





In case of order of such option, following example should be specified: SC-67097/SC-60132 (where SC-67097 - A, SC-60132 - B). Option is available at no extra charge.





Quilting - extra charge to all price groups, lead time 30-40 working days.

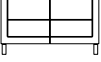
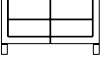

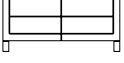
Profim VANCOUVER LITE

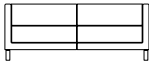
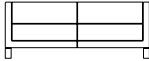
- Armchairs and sofas (in three sizes) come on metal cantilever and metal or wooden legs
- Complementary elements include a TV mount and media ports
- The collection is complemented by a simple wall which is used to connect the set in the shape of the letter "U"

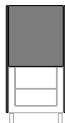
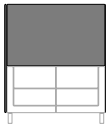
Item no	Base model +	Price Group (PG)	Price Group						Price
			0	①	②	③	④	⑤	
MVT100H000	Profim VANCOUVER LITE VL1 H • armchair • legs • frame: black / MetallicPro / wooden legs		6 074	6 327	6 961	7 278	7 593	8 859	9 494
MVT100V000	Profim VANCOUVER LITE VL1 V • armchair • cantilevers • frame: black / MetallicPro		6 596	6 871	7 557	7 901	8 244	9 619	10 305
MVT200H000	Profim VANCOUVER LITE VL2 H • 2-seat sofa • legs • frame: black / MetallicPro / wooden legs		7 567	7 883	8 670	11 206	15 046	11 035	11 822
MVT200V000	Profim VANCOUVER LITE VL2 V • 2-seat sofa • cantilevers • frame: black / MetallicPro		8 089	8 425	9 267	9 688	10 109	11 795	12 638
MVT250H000	Profim VANCOUVER LITE VL2,5H • 2,5-seat sofa • legs • frame: black / MetallicPro / wooden legs		8 518	8 873	9 760	10 205	10 648	12 423	13 311
MVT250V000	Profim VANCOUVER LITE VL2,5V • 2,5-seat sofa • cantilevers • frame: black / MetallicPro		8 969	9 417	10 359	10 830	11 299	13 184	14 125

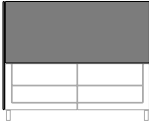
Item no	Base model +	Price Group (PG)	Price Group						Price
			0	①	②	③	④	⑤	
MVT300H000	Profim VANCOUVER LITE VL3 H • 3-seat sofa • legs • frame: black / MetallicPro / wooden legs		10 452	12 847	15 266	12 681	13 231	15 437	16 541
MVT300V000	Profim VANCOUVER LITE VL3 V • 3-seat sofa • cantilevers • frame: black / MetallicPro		11 108	11 570	12 728	13 307	13 883	16 199	17 354
MVTSW00000	Profim VANCOUVER LITE VL SW • straight connecting wall		2 175	2 266	2 493	2 605	2 718	3 170	
MVTW100000	Profim VANCOUVER LITE VL W1 • set of partition walls to be connected with armchair		7 044	7 338	8 073	8 440	8 808	10 274	
MVTW200000	Profim VANCOUVER LITE VL W2 • set of partition walls to be connected with 2-seater sofa		7 997	8 331	9 166	9 582	9 996	11 664	
MVTW250000	Profim VANCOUVER LITE VL W2,5 • set of partition walls to be connected with 2,5-seater sofa		9 113	9 494	10 440	10 917	11 391	13 288	
MVTW300000	Profim VANCOUVER LITE VL W3 • set of partition walls to be connected with 3-seater sofa		11 359	11 833	13 014	13 607	14 199	16 564	

Accessories/Options/Surcharges:

7TFRA013	Connecting with walls (HW/VW) (Only for: VL1 H, VL1 V)	438
7TFRA013	Connecting with walls (HW/VW) (Only for: VL2 H, VL2 V)	765
7TFRA013	Connecting with walls (HW/VW) (Only for: VL2,5H, VL2,5V, VL3 H, VL3 V)	1021
7QUEL004	Quilting - inner surface (Q6) (Only for: VL SW)	2625
7QUEL004	Quilting - inner surface (Q6) (Only for: VL W1)	3014
7QUEL004	Quilting - inner surface (Q6) (Only for: VL W2)	4181
7QUEL004	Quilting - inner surface (Q6) (Only for: VL W2,5)	4765
7QUEL004	Quilting - inner surface (Q6) (Only for: VL W3)	10696
7QUEL006	Quilting - outer surface (Q7) (Only for: VL1 H, VL1 V)	1264
7QUEL006	Quilting - outer surface (Q7) (Only for: VL2 H, VL2 V)	1653
7QUEL006	Quilting - outer surface (Q7) (Only for: VL2,5H, VL2,5V)	1835
7QUEL006	Quilting - outer surface (Q7) (Only for: VL3 H, VL3 V)	2334
7QUEL006	Quilting - outer surface (Q7) (Only for: VL SW)	3099
7QUEL006	Quilting - outer surface (Q7) (Only for: VL W1)	3707
7QUEL006	Quilting - outer surface (Q7) (Only for: VL W2)	5069
7QUEL006	Quilting - outer surface (Q7) (Only for: VL W2,5)	5627
7QUEL006	Quilting - outer surface (Q7) (Only for: VL W3)	13030
7TFRA016	TV handle (SW HA) (Only for: VL SW)	2079
7ELEC004	Mediaport - electrical outlet 230V and 2 USB ports (Only for: VL1 H, VL1 V, VL2 H, VL2 V, VL2,5H, VL2,5V, VL3 H, VL3 V)	2735

0 price group: Evo

1 price group: Cura, Tonal, Xtreme

2 price group: Select

3 price group: Capture, Oceanic, Step, Synergy

4 price group: Steelcut 3, Steelcut Trio 3

6 price group: Paloma

Glides

Standard:

- hard glides - for soft floors (models H)

- felt pads - for hard floors (models V)

Option:

- felt glides - for hard floors (models H)

When ordering please clearly indicate the chosen option.

Wooden legs: beech wood - H5, H6, H12.

In VL W1, VL W2, VL W2,5, VL W3 option of mixing colours of the same fabric on inner and outer part of the partition wall according to below scheme:

A - inner part of shell, B - outer part of shell.

In case of order of such option, following example should be specified: SC-67097/SC-60132 (gdzie SC-67097 - A, SC-60132 - B). Option is available at no extra charge.

While ordering set of "U-shape" armchairs/sofas (including wall VL SW) please indicate clearly this option on your order. Distance between the seats in "U-shape set" - 940 mm.

Quilting - extra charge to all price groups, lead time 30-40 working days.

SW HA - acceptable dimension of TV: max. diagonal of the screen - 40 inches, max. weight - 10 kg.



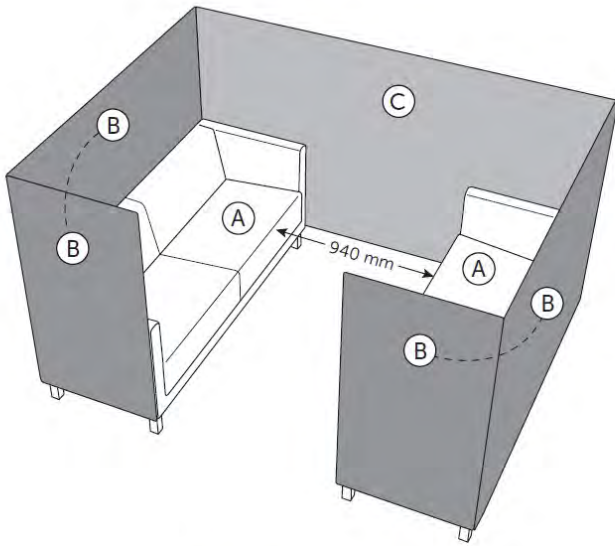

Sample of „U-shape” set with 3-seater sofas.

2 x A: VL 3 HW/VW
 (3-seat sofa, to be connected with partition walls)

2x B: VL W3
 (set of partition walls to be connected with 3-seater sofa)

1 x SW: VL SW
 (wall)

While ordering set of "U-shape" armchairs/sofas (including wall VL SW) please indicate clearly this option on your order.

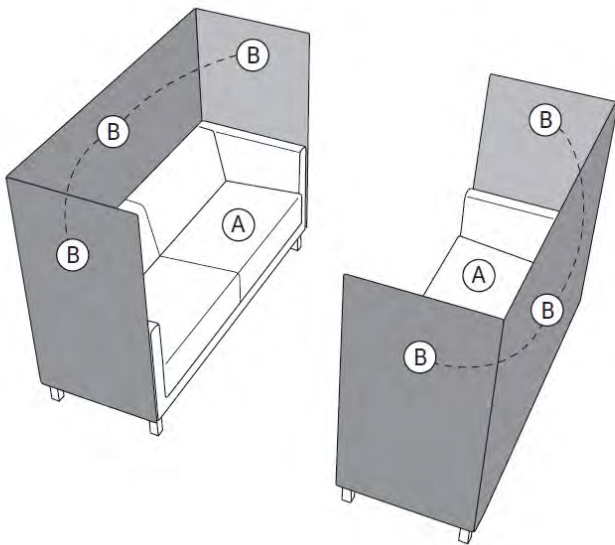









Sample of set with separate 3-seater sofas.

2 x A: VL 3 HW/VW
 (3-seat sofa, to be connected with partition walls)

2 x B: VL W3
 (set of partition walls to be connected with 3-seater sofa).

Profim VANCOUVER OTO

- Available in two sizes and two shapes
- The set is also available as a pouffe + table in the version with an added glass top
- Possibility of connecting cubic pouffes by means of a linking element
- The mediaport is a complementary element

Item no	Base model +	Price Group (PG)	Price Group						Price
			0	①	②	③	④	⑤	
MVOR200000	Profim VANCOUVER OTO VOR2 • small round pouffe • ø 410 mm	 	1 761	1 834	2 019	2 109	2 201	2 568	2 753
MVOR100000	Profim VANCOUVER OTO VOR1 • large round pouffe • ø 540 mm	 	1 961	2 042	2 244	2 346	2 449	2 857	3 061
MVOS200000	Profim VANCOUVER OTO VOS2 • small square pouffe • 410 x 410 mm	 	1 920	2 212	2 795	2 196	2 291	3 659	5 056
MVOS100000	Profim VANCOUVER OTO VOS1 • large square pouffe • 540 x 540 mm	 	2 228	2 321	2 553	2 671	2 786	3 250	3 481

Accessories/Options/Surcharges:

7TATO002	Table top milky tempered glass (Only for: VOR1, VOR2)	972
7TATO002	Table top milky tempered glass (Only for: VOS1, VOS2)	1 130
7ELEC004	Mediaport - electrical outlet 230V and 2 USB ports (Only for: VOS1, VOS2)	2 735
7QUEL006	Quilting - outer surface (Q7)	1 069

0 price group: Evo

1 price group: Cura, Tonal, Xtreme

2 price group: Select

3 price group: Capture, Oceanic, Step, Synergy

4 price group: Steelcut 3, Steelcut Trio 3

6 price group: Paloma

Glides

Standard:

- hard glides - for soft floors.

Option:

- felt glides - for hard floors.

When ordering please clearly indicate the chosen option.

Table top G1 - lead time 20-30 working days.





Quilting - extra charge to all price groups, lead time 30-40 working days.





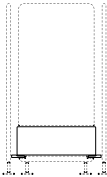

Profim WALL IN

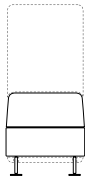

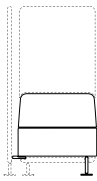
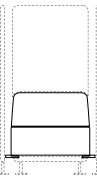
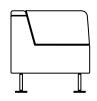
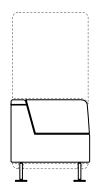
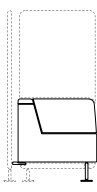
Tomek Rygalik, Studio Rygalik

- Walls enabling the division of the interior and the introduction of distance
- Possibility to choose upholstery colour
- Legs finished with aesthetic plates, available in three colours
- The mediaport is a complementary element

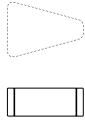
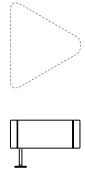
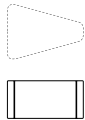
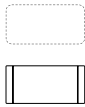
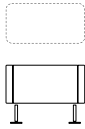
Item no	Base model +	Price Group (PG)	Price Group						Price
			0	①	②	③	④	⑤	
MWA1000000	Profim WALL IN 10 • pouffe • frame: black / MetallicPro		4 260	4 437	4 880	5 102	5 325	6 211	6 657
MWA1100000	Profim WALL IN 11 • pouffe to be connected with 1 partition wall • frame: black / MetallicPro		4 260	4 437	4 880	5 102	5 325	6 211	6 657
MWA1200000	Profim WALL IN 12 • pouffe to be connected with 2 partition walls • frame: black / MetallicPro		4 402	4 586	5 044	5 276	5 502	6 421	6 879
MWA1300000	Profim WALL IN 13 • pouffe to be connected with 3 partition walls • frame: black / MetallicPro		4 402	4 586	5 044	5 276	5 502	6 421	6 879
MWA2000000	Profim WALL IN 20 • armchair • frame: black / MetallicPro		5 572	5 804	6 383	6 674	6 964	8 126	8 708
MWA2100000	Profim WALL IN 21 • armchair to be connected with 1 partition wall • frame: black / MetallicPro		5 572	5 804	6 383	6 674	6 964	8 126	8 708

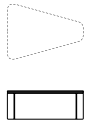
Item no	Base model +	Price Group (PG)	Price Group						Price
			0	①	②	③	④	⑤	
MWA2200000	Profim WALL IN 22 • armchair to be connected with 2 partition walls • frame: black / MetallicPro		5 715	5 953	6 548	6 845	7 145	8 334	8 930
MWA2300000	Profim WALL IN 23 • armchair to be connected with 3 partition walls • frame: black / MetallicPro		5 715	5 953	6 548	6 845	7 145	8 334	8 930
MWA3000000	Profim WALL IN 30 • corner armchair • frame: black / MetallicPro		6 362	6 627	7 290	7 621	7 953	9 279	9 941
MWA3100000	Profim WALL IN 31 • corner armchair to be connected with 1 partition wall • frame: black / MetallicPro		6 362	6 627	7 290	7 621	7 953	9 279	9 941
MWA3200000	Profim WALL IN 32 • corner armchair to be connected with 2 partition walls • frame: black / MetallicPro		6 507	6 777	7 455	7 794	8 132	9 488	10 166
MWAW110000	Profim WALL IN W11 • single partition wall to be connected with 1 seat • frame: black / MetallicPro		2 840	2 958	3 254	3 401	3 550	4 142	
MWAW120000	Profim WALL IN W12 • single partition wall to be connected with 2 seats • frame: black / MetallicPro		2 840	2 958	3 254	3 401	3 550	4 142	

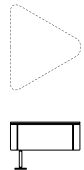
Item no	Base model +	Price Group (PG)	Price Group						Price
			0	①	②	③	④	⑤	
MWAC100000	Profim WALL IN C1 • pouffe • 30°connector		2 606	2 714	2 986	3 123	3 257	3 800	4 073
MWAC200000	Profim WALL IN C2 • pouffe • 60°connector • frame: black / MetallicPro		3 361	3 501	3 852	4 025	4 201	4 900	5 252
MWAP100000	Profim WALL IN P1 • pouffe • 30° armrest		2 805	2 921	3 213	3 360	3 505	4 088	4 381
MWAP300000	Profim WALL IN P3 • pouffe • rectangular armrest		2 534	2 640	2 904	3 036	3 168	3 696	3 961
MWAP400000	Profim WALL IN P4 • pouffe • rectangular armrest on legs • frame: black / MetallicPro		3 380	3 522	3 872	4 047	4 224	4 928	5 279
MWAB000000	Profim WALL IN B • square table • frame: black / MetallicPro		5 033	5 243	5 767	6 028	6 291	7 338	7 862
MWAB100000	Profim WALL IN B1 • table • 30°connector		6 633	6 909	7 600	7 944	8 290	9 670	10 361

Item no	Base model +	Price Group (PG)	Price Group						Price
			0	①	②	③	④	⑤	
MWAB200000	Profim WALL IN B2 • table • 60°connector • frame: black / MetallicPro		5 177	5 392	5 932	6 202	6 470	7 549	8 087
MWABW10000	Profim WALL IN BW1 • square table to be connected with 1 partition wall • frame: black / MetallicPro		6 633	6 909	7 600	7 944	8 290	9 670	10 361
MWABW20000	Profim WALL IN BW2 • square table to be connected with 2 partition walls • frame: black / MetallicPro		5 033	5 243	5 767	6 028	6 291	7 338	7 862

Accessories/Options/Surcharges:

	Table top HPL (Only for: B, BW1, BW2)	1 981
	Table top HPL (Only for: B1)	1 653
	Table top HPL (Only for: B2)	2 309
7JIRO001	Possibility of joining in rows	48
7ELEC004	Mediaport - electrical outlet 230V and 2 USB ports (Only for: 10, 11, 12, 13, 20, 21, 22, 23, 30, 31, 32)	2 795
7QUEL004	Quilting - inner surface (Q6) (Only for: 10, 11, 12, 13, C2)	572
7QUEL004	Quilting - inner surface (Q6) (Only for: 20, 21, 22, 23)	705
7QUEL004	Quilting - inner surface (Q6) (Only for: 30, 31, 32)	790
7QUEL004	Quilting - inner surface (Q6) (Only for: C1, P1, P3, P4)	413

0 price group: Evo

1 price group: Cura, Tonal, Xtreme

2 price group: Select

3 price group: Capture, Oceanic, Step, Synergy

4 price group: Steelcut 3, Steelcut Trio 3

6 price group: Paloma

Glides

Standard:

- metal glides - for soft floors.

Option:

- felt glides - for hard floors.

When ordering please clearly indicate the chosen option.

Model P4 (on legs) allows the completion of any system.

Glides and linking parts for partition walls are provided with the seat to be connected with the partition wall.

Wall In W11/W12 models never occur as freestanding elements.

Table top G1 - lead time 20-30 working days.

Colours of HPL (LW): White (LW01), Light Grey (LW03); Grey (LW04), Black (LW02), Navy Blue (LW06), Light Burgundy (LW07) - lead time 20-30 working days.

Quilting - extra charge to all price groups, lead time 30-40 working days.









Tables







Coat stands





Accessories

Profim ALLROUND

- Table top in Laminate and Linoleum (24 mm) or Melamine Beech (22 mm)
- Table edge band will match table top colour as standard. Optionally choose black, white or grey table edge band to any table top colour within our rangewithout extra charge.

Item no	Base model +	Price Group (PG)	①	②	③	Price
5180-30	Profim ALLROUND 5180-30 (E) <ul style="list-style-type: none"> • Tables, height 73/90 cm • 80 x 80 cm with column frame base with 4 star footbase 		3 246	4 383	5 697	
5180-10	Profim ALLROUND 5180-10 (E) <ul style="list-style-type: none"> • Table, height 73/90 cm • 180 x 90 cm with T frame • Distance between legs 110 cm 		4 802	7 299	9 488	
5180-22	Profim ALLROUND 5180-22 (S) <ul style="list-style-type: none"> • Table, height 73/90 cm • 180 x 80 cm with T frame • Distance between table legs 110 cm 		4 676	6 932	9 011	
5180-24	Profim ALLROUND 5180-24 (E) <ul style="list-style-type: none"> • Table, height 73/90 cm • 160 x 80 cm with T frame • Distance between table legs 110 cm 		4 555	6 593	8 572	
5180-25	Profim ALLROUND 5180-25 (S) <ul style="list-style-type: none"> • Table, height 73/90 cm • 140 x 80 cm with T frame • Distance between table legs 80 cm • Weight approx. 24.5 kg Lam. 		4 436	6 500	8 450	
5180-27	Profim ALLROUND 5180-27 (S) <ul style="list-style-type: none"> • Table, height 73/90 cm • 120 x 80 cm with T frame • Distance between table legs 80 cm 		4 349	6 290	8 176	

Item no	Base model +	Price Group (PG)	①	②	③	Price
5180-36	Profim ALLROUND 5180-36 (E) <ul style="list-style-type: none"> • Table, height 73/90 cm • 180 x 70 cm with T frame • Distance between table legs 110 cm 		4 555	6 567	8 538	
5180-38	Profim ALLROUND 5180-38 (S) <ul style="list-style-type: none"> • Table, height 73/90 cm • 140 x 70 cm with T frame • Distance between table legs 80 cm 		4 373	6 350	8 255	
5180-39	Profim ALLROUND 5180-39 (S) <ul style="list-style-type: none"> • Table, height 73/90 cm • 120 x 70 cm with T frame • Distance between table legs 80 cm 		4 260	5 997	7 795	
5182-10	Profim ALLROUND 5182-10 (E) <ul style="list-style-type: none"> • Round table with frame base, height 50/73 cm • Ø60 cm - 4 star footbase 		3 229	4 560	5 928	
5182-102	Profim ALLROUND 5182-102 (E) <ul style="list-style-type: none"> • High table, height 90/110 cm • Ø60 cm - 4 star footbase 		3 444	4 728	6 146	
5182-15	Profim ALLROUND 5182-15 (S) <ul style="list-style-type: none"> • Round table with frame base, height 50/73 cm • Ø70 cm - 4 star footbase 		3 390	4 790	6 226	
5182-152	Profim ALLROUND 5182-152 (E) <ul style="list-style-type: none"> • High table, height 90/110 cm • Ø70 cm - 4 star footbase 		3 556	4 954	6 441	

Item no	Base model +	Price Group (PG)	①	②	③	Price
5182-20	Profim ALLROUND 5182-20 (E) <ul style="list-style-type: none"> • Round table with frame base, height 50/73 cm • Ø80 cm - 4 star footbase 		3 597	5 077	6 600	
5182-202	Profim ALLROUND 5182-202 (E) <ul style="list-style-type: none"> • High table, height 90/110 cm • Ø80 cm - 4 star footbase 		3 767	5 242	6 813	
5182-25	Profim ALLROUND 5182-25 (E) <ul style="list-style-type: none"> • Round table with frame base, height 50/73 cm • Ø100 cm - 5 star footbase 		4 123	5 908	7 680	
5182-30	Profim ALLROUND 5182-30 (E) <ul style="list-style-type: none"> • Round table with frame base, height 50/73 cm • Ø120 cm - 5 star footbase 		4 456	6 603	8 584	
5184-01	Profim ALLROUND 5184-01 (E) <ul style="list-style-type: none"> • Ellipse table • Height 73/90 cm • 180 x 100 cm with T frame, seats 6 • Distance between table legs 110 cm 		6 059	8 280	10 765	

1. Melamine on chipboard (only beech)

2. Laminate on chipboard

3. Linoleum on chipboard

Height: 50/73/90/110 cm

Profim Allround table tops (rectangular and squared shapes) can be made available with MDF table core, chamfered edges of 20 degr and with a 10 mm black, white or grey edge band and black paint

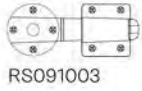

S=Standard Collection - normal production time 20-30 working days. Applicable when table top and base are standard (S).





E=Extended Collection - normal production time 30-35 working days (Linoleum: 35 working days). Applicable when any or all component options selected are extended (E).

For larger orders, please contact Customer Service for delivery details.



Profim EMINENT

- Ø38 mm tubular table leg in various colours. See below Accessories/options. Incl. levelling feet (up to 17 mm on all legs)
- Table tops in various colours, see below Accessories/options.
- Table edge band will match table top colour as standard. Optionally choose black, white or grey table edge band to any table top colour within our range without extra charge.
- Table suspension brackets for several tables available for Profim Ana and Noor (except 6080/85). Cannot be attached to round tables

Item no	Base model +	Price Group (PG)	①	②	③	Price
4590-22	Profim EMINENT 4590-22 • 180 x 80 cm • Distance between the table legs 164 cm • Weight appr 33.2 kg Lam.		4 646	5 729	7 447	
4590-24	Profim EMINENT 4590-24 • 160 x 80 cm • Distance between the table legs 144 cm • Weight appr 29.8 kg Lam.		4 406	5 288	6 874	
4590-25	Profim EMINENT 4590-25 • 140 x 80 cm • Distance between the table legs 124 cm • Weight appr 27.3 kg Lam.		4 420	5 300	6 892	
4590-27	Profim EMINENT 4590-27 • 120 x 80 cm • Distance between the table legs 104 cm • Weight appr 24.2 kg Lam.		3 869	4 682	6 088	
4590-30	Profim EMINENT 4590-30 • 80 x 80 cm • Distance between the table legs 64 cm • Weight appr 18.7 kg Lam.		3 334	4 063	5 283	

Item no	Base model +	Price Group (PG)	①	②	③	Price
4590-38	Profim EMINENT 4590-38 • 140 x 70 cm • Distance between the table legs 124 cm • Weight appr 25.2 kg Lam.		4 346	5 212	6 775	
4590-52	Profim EMINENT 4590-52 • 140 x 60 cm • Distance between the table legs 124 cm • Weight appr 23 kg Lam.		4 166	5 027	6 536	
4590-54	Profim EMINENT 4590-54 • 120 x 60 cm • Distance between the table legs 104 cm • Weight appr 20.4 kg Lam		3 250	4 245	5 518	
4592-30	Profim EMINENT 4592-30 • Ø120 cm with 4 legs • Distance between the table legs 60 cm		4 332	6 056	7 873	
4592-50	Profim EMINENT 4592-50 • Ø160 cm with 4 legs • Distance between the table legs 91 cm		6 681			
4593-15	Profim EMINENT 4593-15 • Trapezium 140 x 70 x 70 x 70, depth 60 cm • Distance between the table legs 116/53/60 cm		4 519	5 419	7 044	

1. Melamine on chipboard (only beech)

2. Laminate on chipboard

3. Linoleum on chipboard

Table top in Laminate and Linoleum (24 mm) or Melamine Beech (22 mm)
 Height approx. 73.5 cm. Table leg adjustment screw on legs

** See separate page "Table/chair suspension bracket system" for details



S=Standard Collection – normal production time 20-30 working days. Applicable when table top and base are standard (S).

E=Extended Collection – normal production time 30-35 working days (Linoleum: 35 working days). Applicable when any or all component options selected are extended (E).

For larger orders, please contact Customer Service for delivery details.

Table/chair suspension bracket system for Eminent table

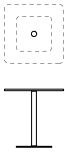
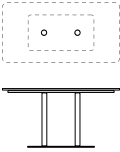
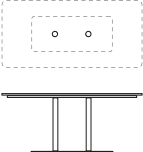

Table size (Length x width)	Width between legs (width chair)	Noor 6050/6055* (M30410 Bracket)	Noor 6060/6065* (M30410 Bracket)	Noor 6070/6075* (M30410 Bracket)	Ana	Com H/V (M30403 Bracket)
1200x600	1046x(446)	1	1	1	1 (M130350)	1 or 2
800x800	646x(646)	1 on both sides	1 on both sides	1 on both sides	2 on same side (M130355)	1 on both sides
1200x800	1046	1 on both sides	1 on both sides	1 or 2 on both sides	2 (1 on both sides) (M130360)	1 or 2 on both sides
1400x600	1246	1 or 2 on one side	1 or 2 on one side	1 or 2 on one side	4 (2 on both sides) (M130365)	1 or 2
1400x700	1246	1 or 2 on both sides	1 or 2 on both sides	1 or 2 on both sides	-	1 or 2 on both sides
1400x800	1246	1 or 2 on both sides	1 or 2 on both sides	1 or 2 on both sides	-	1 or 2 on both sides
1600x800	1446	1 or 2 on both sides	1 or 2 on both sides	1 or 2 on both sides	-	1 or 2 on both sides
1800x800	1646	1, 2 or 3 on both sides	1 or 2 on both sides	1 or 2 on both sides	6 (3 on both sides) (M130370)	1, 2 or 3 on both sides





* Valid for unupholstered chair, upholstered Seat (S), upholstered Seat and Back (SB) and Fully upholstered (F) variants. Table suspension bracket not applicable for Noor 6080/6085

Profim REVO TABLES

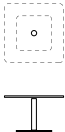
Pearson Lloyd

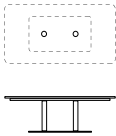
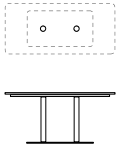
- tables and table frames of different length and height and shape
- designed with comfort in mind
- versatile and lightweight design
- various color palette of table tops and frames

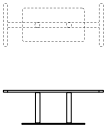
Item no	Base model +	Price Group (PG)	①	②	Price
MRVT750000	Profim REVO T75 • table 750 x 750 mm • height 740 mm • square, flat base		8 642	9 201	
MRVT150000	Profim REVO T150 • table 1500 x 750 mm • height 740 mm • rectangular, flat base		16 190	16 955	
MRVT180000	Profim REVO T180 • table 1800 x 850 mm • height 740 mm • rectangular, flat base		18 644	20 310	
MRVLS65000	Profim REVO LS65 • table 650 x 350 mm • height 665 mm • rectangular, flat base		5 809	6 174	
MRVLR48000	Profim REVO LR48 • table round Ø 480 mm • height 665 mm • round base, flat base		5 809	6 174	
MRVC750000	Profim REVO C75 • low table 750 x 750 mm • height 450 mm • square, flat base		8 374	8 946	

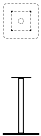
Item no	Base model +	Price Group (PG)	①	②	Price
MRVC150000	Profim REVO C150 • low table 1500 x 750 mm • height 450 mm • rectangular, flat base		15 643	16 396	
MRVT140000	Profim REVO MT140 • medium table 1400 x 700 mm • height 650 mm • rectangular, flat base		12 569	13 149	
MRVC75000F	Profim REVO FRAME C75 • table's frame • height 440 mm • square, flat base				5 253
MRVC15000F	Profim REVO FRAME C150 • table's frame • height 440 mm • rectangular, flat base				10 156
MRVLR4800F	Profim REVO FRAME LR48 • table's frame • height 655 mm • round base, flat base				4 295
MRVLS6500F	Profim REVO FRAME LS65 • table's frame • height 655 mm • rectangular, flat base				4 460
MRVT75000F	Profim REVO FRAME T75 • table's frame • height 730 mm • square, flat base				5 665

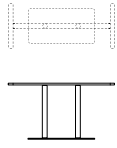
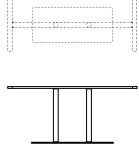
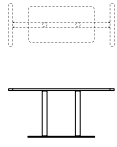
Item no	Base model +	Price Group (PG)	①	②	Price
MRVT15000F	Profim REVO FRAME T150 • table's frame • height 730 mm • rectangular, flat base				11 093
MRVT18000F	Profim REVO TABLES FRAME T180 • table's frame • height 730 mm • rectangular, flat base				12 597
MRVT14000F	Profim REVO FRAME MT140 • table's frame • height 640 mm • rectangular, flat base				10 815

1. Natural veneers / Natural colored veneers (ash)Frame

2. HPL

MetallicPro; Black RAL 9005; White RAL 9016; Light Grey NCS S 2500 N; Grey NCS S 6500 N; Deep Green RAL 6004; Navy Blue RAL 5003; Burgundy RAL 3005; Salvia/Green RAL 6021, Blue RAL 5014; Terracota RAL 3012

Natural veneers

Ash (NA), Beech (NB), Oak (NO), Walnut (NW)

Natural colored veneers (ash)

White (CNA01), Black (CNA02), Dark green (CNA05), Navy blue (CNA06), Burgundy (CNA07)

HPL

White (LW01), Light Grey (LW03); Grey (LW04), Black (LW02), Navy Blue (LW06), Light Burgundy (LW07)

There is a possibility of any combination of the top and frame colors.

Natural veneers: Ash (NA); Beech (NB); Oak (NO); Orzech (NW) - delivery time 30 business days.

Natural colored veneers: delivery time 30 business days.

HPL worktops: delivery time 30 business days.

Frame in Revo Tables is dedicated for assembly table tops made only from chipboard, plywood or wood.

Maximum parameters of the table top:

C75- 750 x 750 mm, weight 4kg.

C150 - 1500 x 750 mm, weight 8 kg.

LR48 - Ø 480 mm, weight 1,5 kg.

LS65 - 350 x 650 mm, weight 2kg

T75 - 750 x 750 mm, weight 4kg.



T150 - 1500 x 750 mm, weight 8 kg.

T180 - 1800 x 850 mm, weight 11kg.







MT140 - 1400 x 700 mm, weight 7kg.

Profim STANDARD FOLDING TABLE

- Folding table - 100 mm height when collapsed (with 22 mm table top)
- Frame in various colours. See below Accessories/options.
- For table top colours, see below Accessories/options.
- Table top edge band will match table top as standard. Optionally choose black, white or grey table edge band to any table top colour within our range without extra charge.
- Table top in Laminate (24 mm) or Melamine Beech (22 mm)

Item no	Base model +	Price Group (PG)	①	②	③	Price
4680-10	Profim STANDARD FOLDING TABLE 4680-10 • 180 x 90 cm • Distance between the table legs 103 cm • Weight appr 30.9 kg Lam.		3 758	5 615	7 125	
4680-15	Profim STANDARD FOLDING TABLE 4680-15 • 120 x 90 cm • Distance between the table legs 103 cm • Weight appr 22.6 kg Lam.		3 234	4 553	6 164	
4680-22	Profim STANDARD FOLDING TABLE 4680-22 • 180 x 80 cm • Distance between the table legs 103 cm • Weight appr 28.1 kg Lam.		3 267	5 205	6 602	
4680-24	Profim STANDARD FOLDING TABLE 4680-24 • 160 x 80 cm • Distance between the table legs 103 cm • Weight appr 25.7 kg Lam.		3 169	4 879	6 127	
4680-25	Profim STANDARD FOLDING TABLE 4680-25 • 140 x 80 cm • Distance between the table legs 103 cm • Weight appr 23.2 kg Lam.		3 131	4 565	5 657	

Item no	Base model +	Price Group (PG)	①	②	③	Price
4680-27	Profim STANDARD FOLDING TABLE 4680-27 <ul style="list-style-type: none"> • 120 x 80 cm • Distance between the table legs 103 cm • Weight appr 20.8 kg Lam. 		2 708	4 196	5 014	
4680-36	Profim STANDARD FOLDING TABLE 4680-36 <ul style="list-style-type: none"> • 180 x 70 cm • Distance between the table legs 103 cm • Weight appr 25.4 kg Lam. 		3 169	4 623	5 918	
4680-38	Profim STANDARD FOLDING TABLE 4680-38 <ul style="list-style-type: none"> • 140 x 70 cm • Distance between the table legs 103 cm • Weight appr 21.1 kg Lam. 		2 869	4 123	5 154	
4680-39	Profim STANDARD FOLDING TABLE 4680-39 <ul style="list-style-type: none"> • 120 x 70 cm • Distance between the table legs 103 cm • Weight appr 18.9 kg Lam. 		2 708	3 961	4 847	
4680-52	Profim STANDARD FOLDING TABLE 4680-52 <ul style="list-style-type: none"> • 140 x 60 cm • Distance between the table legs 103 cm • Weight appr 18.9 kg Lam. 		3 021	4 153	4 797	
4680-54	Profim STANDARD FOLDING TABLE 4680-54 <ul style="list-style-type: none"> • 120 x 60 cm • Distance between the table legs 103 cm • Weight appr 17.1 kg Lam. 		2 503	3 747	4 360	

Item no	Base model +	Price Group (PG)	①	②	③	Price
4680-58	Profim STANDARD FOLDING TABLE 4680-58 <ul style="list-style-type: none"> Exam table 90 x 60 cm Distance between the table legs 75 cm Weight appr 14.3 kg Lam. 		2256	3169	3727	
4680-90	Profim STANDARD FOLDING TABLE 4680-90 <ul style="list-style-type: none"> 120 x 45 cm Distance between the table legs 103 cm Weight appr 14.3 kg Lam. 		2329	3306	3838	
4681-45	Profim STANDARD FOLDING TABLE 4681-45 <ul style="list-style-type: none"> 1/2 circle with folding frame, Ø160 cm Distance between the table legs 74 cm 		3595	5503	5810	
4688-52	Profim STANDARD FOLDING TABLE 4688-52 <ul style="list-style-type: none"> L-frame 140 x 60 cm Distance between the table legs 103 cm Weight appr 18.9 kg Lam. 		3021	4153	4797	
4688-54	Profim STANDARD FOLDING TABLE 4688-54 <ul style="list-style-type: none"> L-frame 120 x 60 cm Distance between the table legs 103 cm Weight appr 17.1 kg Lam. 		2503	3747	4360	
4688-90	Profim STANDARD FOLDING TABLE 4688-90 <ul style="list-style-type: none"> L-frame 120 x 45 cm Distance between the table legs 103 cm Weight appr 14.3 kg Lam. 		2329	3306	3838	

1. Melamine on chipboard (only beech)

2. Laminate on chipboard

Height, approx: 74.5 cm

Trolley with frame. 3211 for transport of 5 upright Profim Standard folding tables. 3212 for transport of 13 upright Profim Standard folding tables. Both trolleys can hold 12 tables lying down

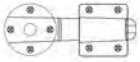

RS091003

S=Standard Collection - normal production time 20-30 working days. Applicable when table top and base are standard (S).

E=Extended Collection - normal production time 30-35 working days. Applicable when any or all component options selected are extended (E).

For larger orders, please contact Customer Service for delivery details.





Lightweight core on request.







Profim U-CONNECT

Acer Design a/s, Justus Kolberg, Erik Simonsen

- Folding tables
- A smart mobile folding table with wheels and can nest together when lined up in the vertical position. The table top is anchored with a bracket in the upright position. The table top can be tipped along its long axis
- Table top edge band will match table top colour as standard. Optionally choose black, white or grey table edge band to any table top colour within our range without extra charge.
- Table top in Laminate or Linoleum (24 mm) and Melamine Beech (22 mm)

Item no	Base model +	Price Group (PG)	①	②	③	④	Price
3490-22	Profim U-CONNECT 3490-22 • 180 x 80 cm • Distance between the table legs 163 cm • Weight appr 31.6 kg Lam.		7 843	9 698	11 082	12 608	
3490-36	Profim U-CONNECT 3490-36 • 180 x 70 cm • Distance between the table legs 163 cm • Weight appr 28.7 kg Lam.		7 755	9 477	10 669	12 320	
3490-24	Profim U-CONNECT 3490-24 • 160 x 80 cm • Distance between the table legs 143 cm • Weight appr 28.7 kg Lam.		7 132	8 817	10 076	11 462	
3490-37	Profim U-CONNECT 3490-37 • 160 x 70 cm • Distance between the table legs 143 cm • Weight appr 26.1 kg Lam.		7 049	8 613	9 698	11 197	
3490-25	Profim U-CONNECT 3490-25 • 140 x 80 cm • Distance between the table legs 123 cm • Weight appr 25.4 kg Lam.		6 483	8 016	9 158	10 422	

Item no	Base model +	Price Group (PG)	①	②	③	④	Price
3490-38	Profim U-CONNECT 3490-38 • 140 x 70 cm • Distance between the table legs 123 cm • Weight appr 23.2 kg Lam.		6 410	7 836	8 817	10 187	
3490-52	Profim U-CONNECT 3490-52 • 140 x 60 cm • Distance between the table legs 123 cm • Weight appr 21 kg Lam.		6 335	7 697	8 483	10 006	
3490-27	Profim U-CONNECT 3490-27 • 120 x 80 cm • Distance between the table legs 103 cm • Weight appr 22.6 kg Lam.		6 384	7 795	8 752	10 134	
3490-39	Profim U-CONNECT 3490-39 • 120 x 70 cm • Distance between the table legs 103 cm • Weight appr 21.6 kg Lam.		6 511	7 637	8 460	9 929	
3490-54	Profim U-CONNECT 3490-54 • 120 x 60 cm • Distance between the table legs 103 cm • Weight appr 18.5 kg Lam.		6 261	7 479	8 167	9 722	

1. Melamine on chipboard (only beech)

2. Laminate on chipboard

3. Linoleum on chipboard

Height 73.5 cm

Features Ø65 mm castors with soft rim and brake

Profim u-Connect table tops (rectangular and squared shapes) can be made available with MDF table core, chamfered edges of 20 degr and with a 10 mm black, white or grey edge band and black paint (see extra charge below)



RBM u-Connect

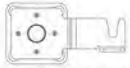

115000338008

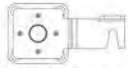

115000338009



S=Standard Collection – normal production time 20-30 working days. Applicable when table top and base are standard (S).

E=Extended Collection – normal production time 30-35 working days (Linoleum: 35 working days). Applicable when any or all component options selected are extended (E).

For larger orders, please contact Customer Service for delivery details.

Lightweight core on request.



MÖBELFAKTA

Profim SEVEN

Tomek Rygalik, Studio Rygalik

- Option of combining colours, it is possible to play with colours (hanger and hooks are available in different shades)

Item no	Base model +	Price Group (PG)	Coat hanger	Price
MSZ0000000	Profim SEVEN • coat hanger		2002	

Hard glides - for soft floors (set).



Colours of frame:

- Black RAL 9005
- MetallicPro
- White RAL 9016
- Lightgrey NCS S 2500-N
- Grey NCS S 6500-N
- Deep green RAL 6004
- Navy blue RAL 5003
- Burgundy RAL 3005
- Salvia/Green RAL 6021
- Blue RAL 5014
- Terracota RAL 3012
- Steelgray

It is possible to order hooks in different colour than the coat stand frame.

Profim CUSHION

- Two sizes
- Several types of fabric

Item no	Base model +	Price Group (PG)	①	②	③	④	Price
MCU3000000	Profim CUSHION CU30 • cushions with filling • 300 x 300 mm		461	717	754	1 130	
MCU4000000	Profim CUSHION CU40 • cushions with filling • 400 x 400 mm		547	790	826	1 325	

1 price group: Cura, Tonal, Xtreme

2 price group: Select

3 price group: Capture, Oceanic, Step, Synergy

4 price group: Steelcut 3, Steelcut Trio 3

Filling: silicon.

Weight:

CU30 - 0,15 kg,

CU40 - 0,25 kg.

Colour of pillowcase is always white.

Allround

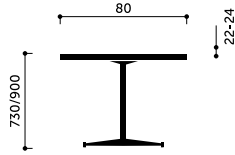

Allround 5180-30

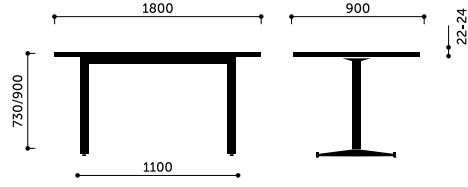

Allround 5180-10

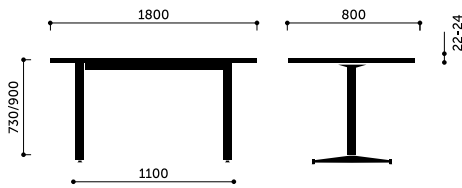

Allround 5180-22

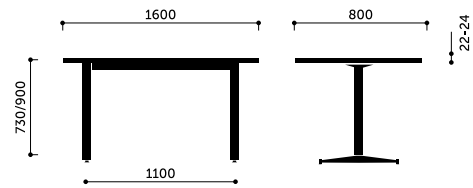

Allround 5180-24

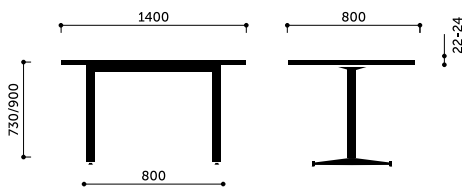

Allround 5180-25

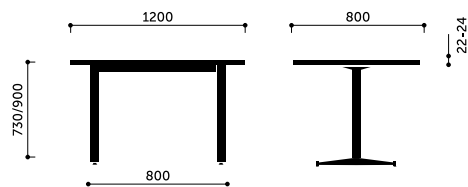

Allround 5180-27

Technical details

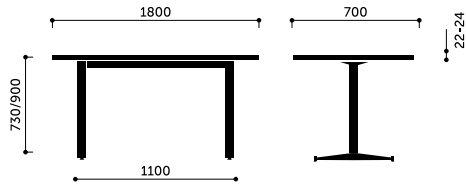

Allround 5180-36

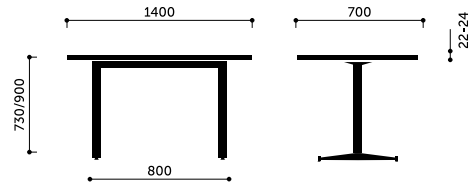

Allround 5180-38

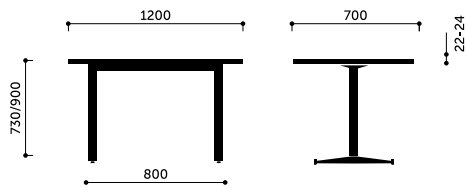

Allround 5180-39

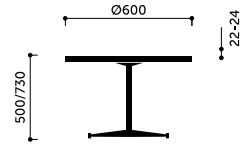

Allround 5182-10

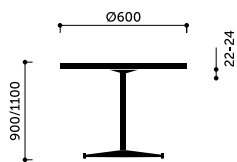

Allround 5182-102

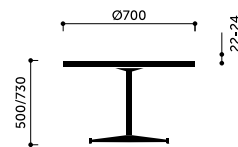

Allround 5182-15

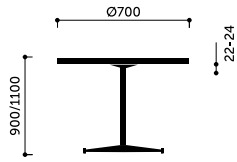

Allround 5182-152

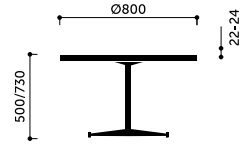

Allround 5182-20

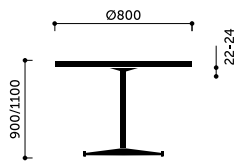

Allround 5182-202

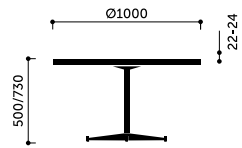

Allround 5182-25

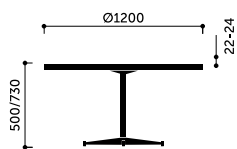

Allround 5182-30

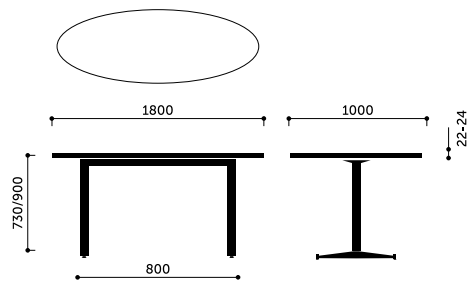

Allround 5184-01

Technical details

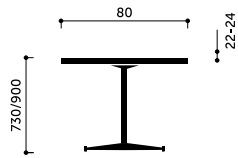

Allround 5180-30

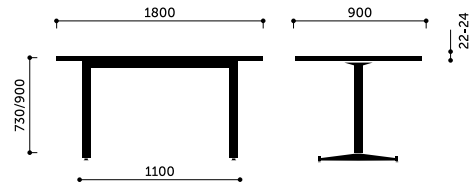

Allround 5180-10

Ana

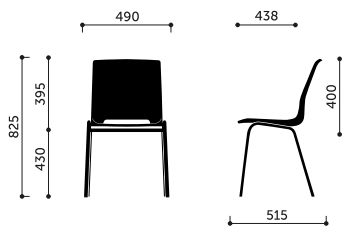

4340 / 4340S / 4340SR

Ariz

550V 580
550V 2P 610
470
450
420 (450)

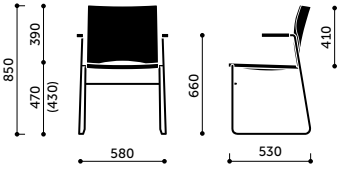

550V / 550V 2P

555V 580
555V 2P 610
470
450
410 (450)

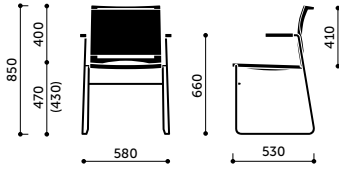

555V / 555V 2P

560V 580
560V 2P 610
470
460
430 (470)

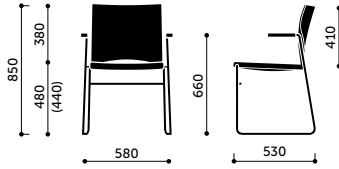

560V / 560V 2P

V	kg 10,5	15	710	1090	650	0,50 m ³
	kg 6,5	45				
V 2P	kg 12,0	10	710	1090	650	0,50 m ³
	kg 8,0	45				

V	kg 10,0	15	710	1090	650	0,50 m ³
	kg 6,0	45				
V 2P	kg 11,5	10	710	1090	650	0,50 m ³
	kg 7,5	45				

V	kg 11,0	5	710	1090	650	0,50 m ³
	kg 7,0	20				
V 2P	kg 12,5	5	710	1090	650	0,50 m ³
	kg 8,5	20				

570V 580
570V 2P 610
500
460
420 (470)

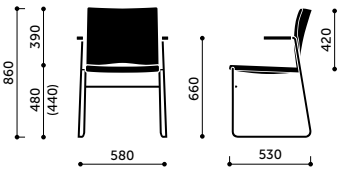

570V / 570V 2P

575V 580
575V 2P 610
470
460
420 (470)

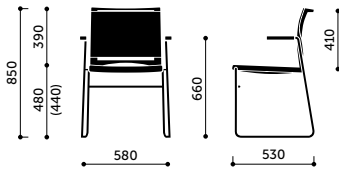

575V / 575V 2P

V	kg 11,5	5	710	1090	650	0,50 m ³
	kg 7,5	20				
V 2P	kg 13,0	5	710	1090	650	0,50 m ³
	kg 9,0	20				

V	kg 10,5	5	710	1090	650	0,50 m ³
	kg 6,5	20				
V 2P	kg 12,0	5	710	1090	650	0,50 m ³
	kg 8,0	20				

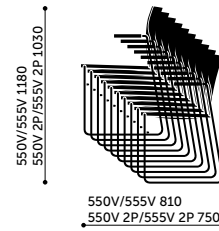

stacking

Technical details

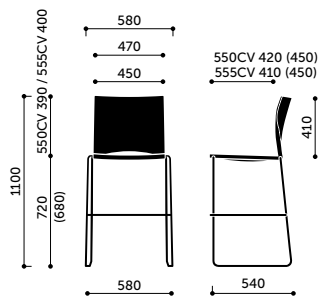

550CV / 555CV

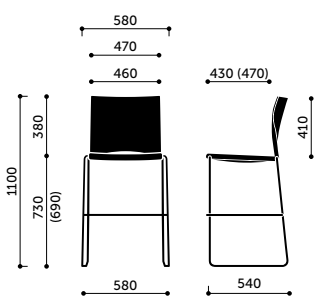

560CV

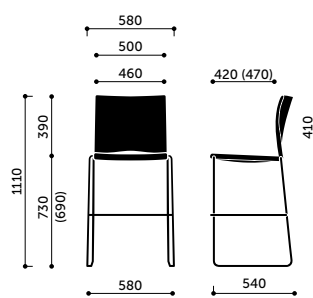

570CV / 575CV

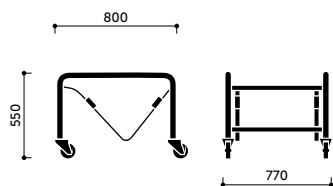
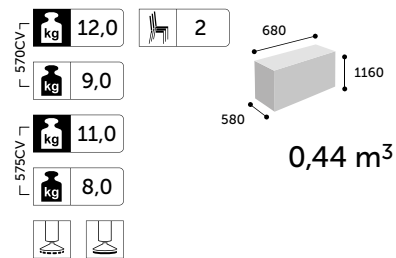
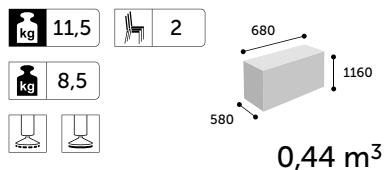
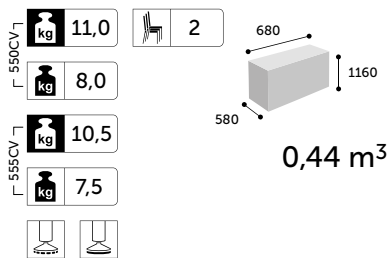

W (chairs trolley)

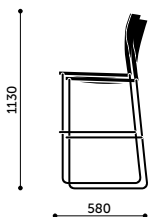

stacking CV

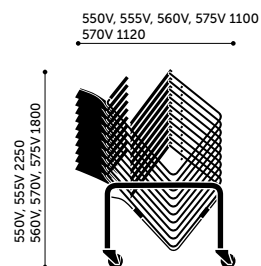

stacking on trolley

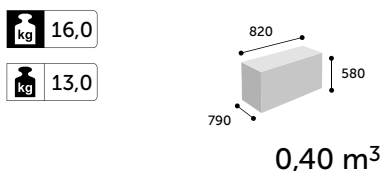

Bit

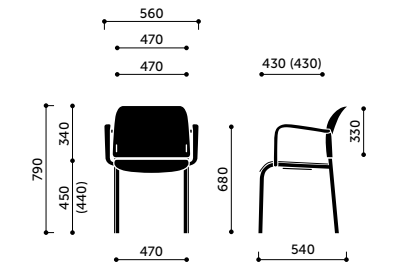

550H / 550H 2P

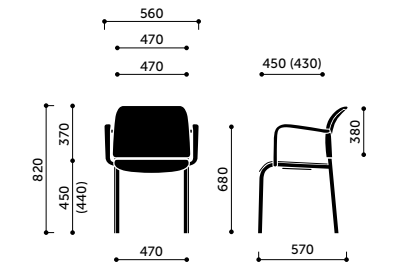

555H / 555H 2P

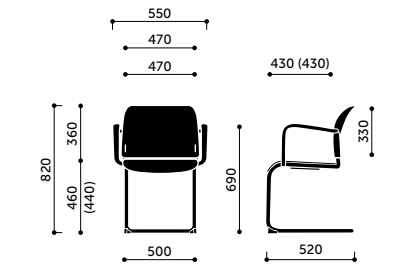

550V / 550V 2P

9,5 kg
5
710
1090
0,50 m³

5,5 kg
10,0 kg
6,0 kg

550H
550H 2P

9,5 kg
5
710
1090
0,50 m³

5,5 kg
10,0 kg
6,0 kg

555H
555H 2P

11,5 kg
3
710
1090
0,50 m³

7,5 kg
12,5 kg
8,5 kg

550V
550V 2P

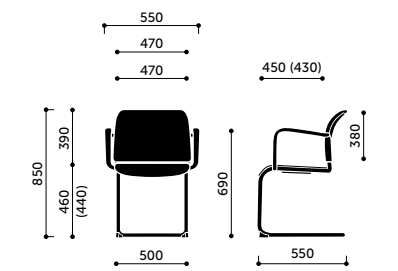

555V / 555V 2P

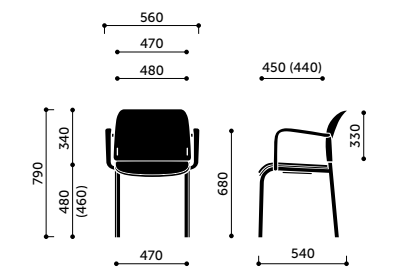

560H / 560H 2P

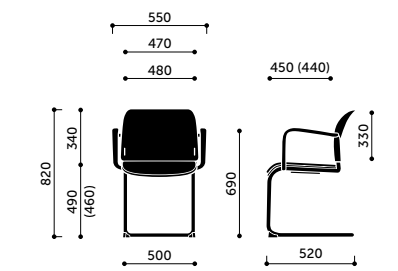

560V / 560V 2P

11,5 kg
3
710
1090
0,50 m³

7,5 kg
12,5 kg
8,5 kg

555V
555V 2P

10,5 kg
3
710
1090
0,50 m³

6,5 kg
11,0 kg
7,0 kg

560H
560H 2P

12,0 kg
3
710
1090
0,50 m³

8,0 kg
13,0 kg
9,0 kg

560V
560V 2P

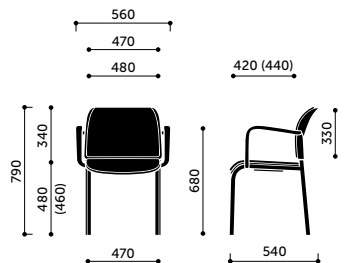

570H / 570H 2P

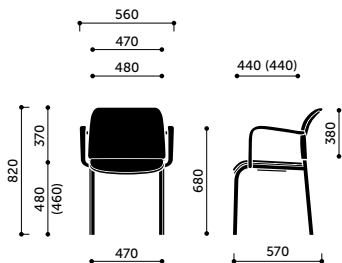

575H / 575H 2P

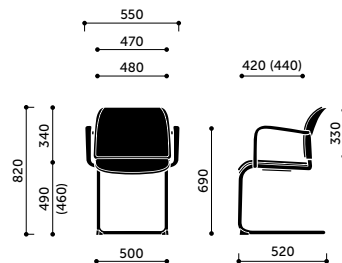

570V / 570V 2P

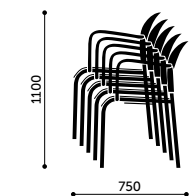

stacking H

11,0 kg
3
710
1090
0,50 m³

7,0 kg
11,5 kg
7,5 kg

570H
570H 2P

10,5 kg
3
710
1090
0,50 m³

6,5 kg
11,0 kg
7,0 kg

575H
575H 2P

12,5 kg
3
710
1090
0,50 m³

8,5 kg
13,5 kg
9,5 kg

570V
570V 2P

Technical details

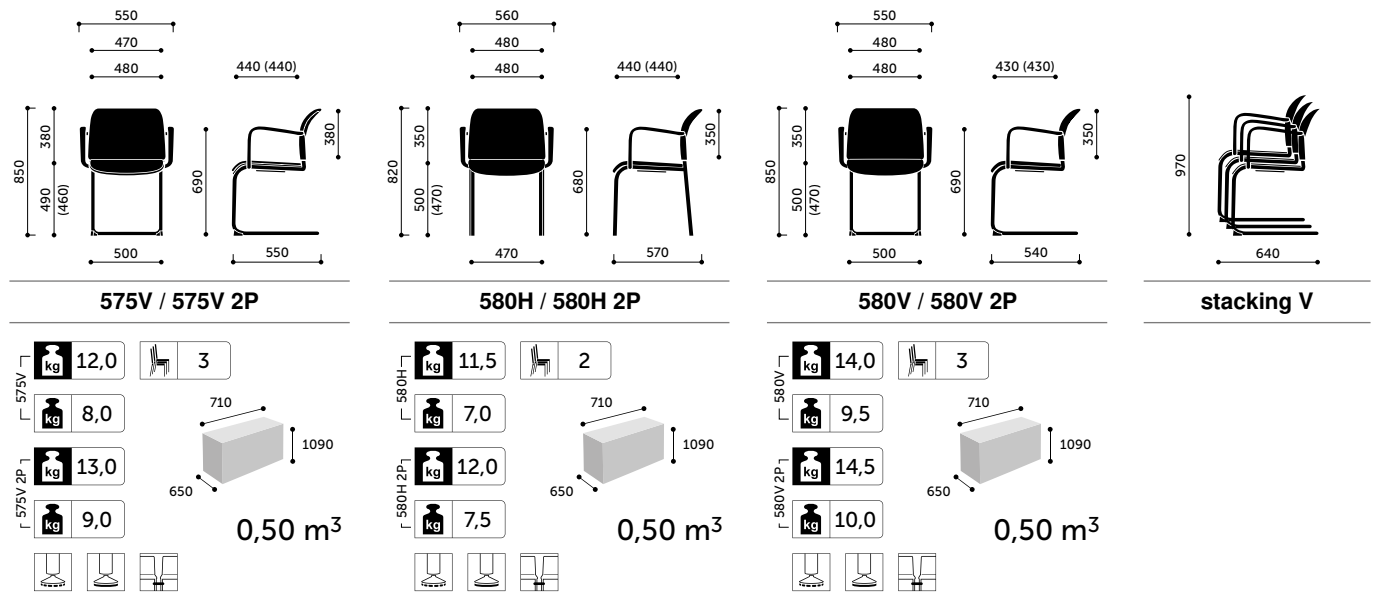

Chic

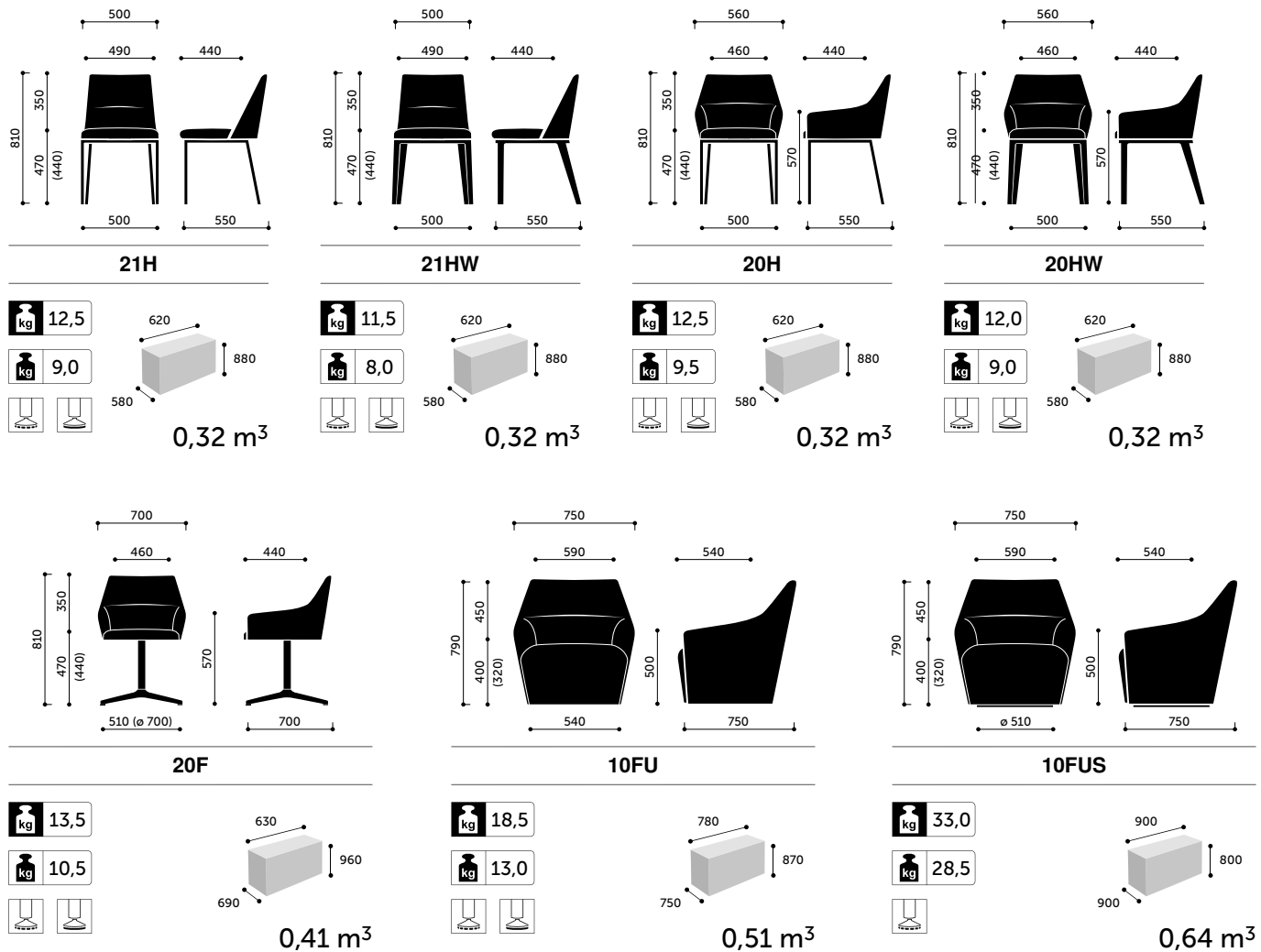

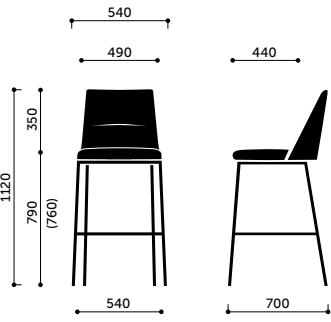

21CH

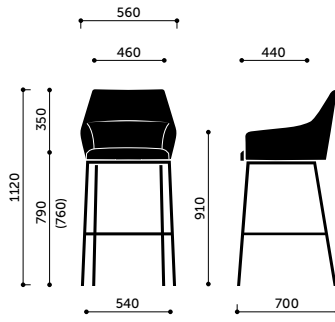
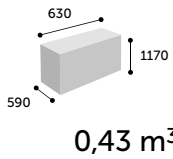
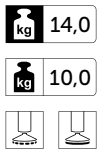

20CH

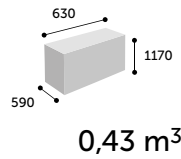
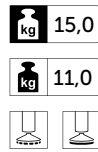

Chic Lounge

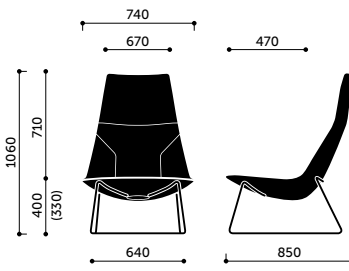

A10V3

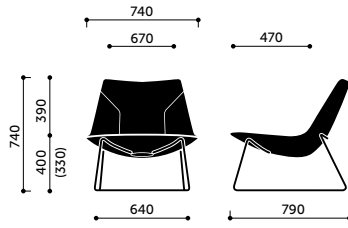
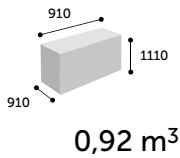
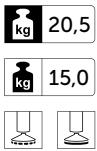

A20V3

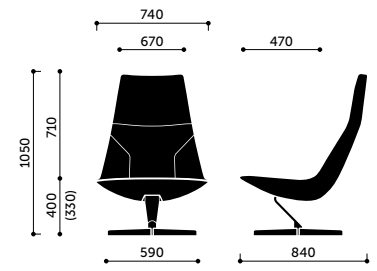
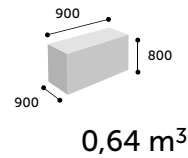
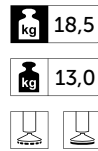

A10F

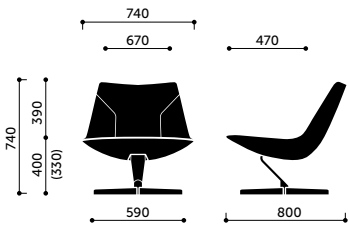
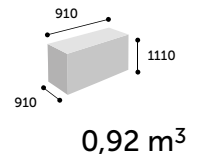
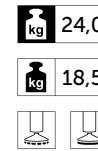

A20F

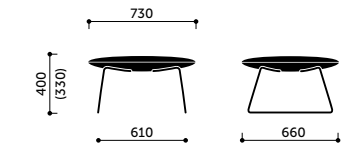
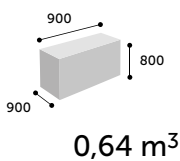
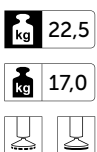

PV3

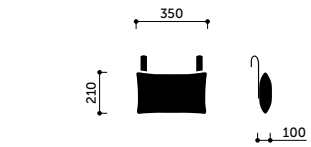
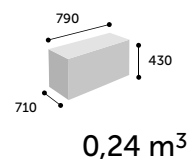
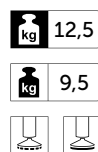

CU

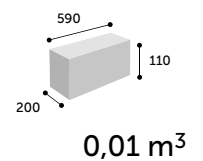
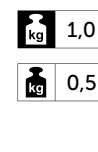

Technical details

Com

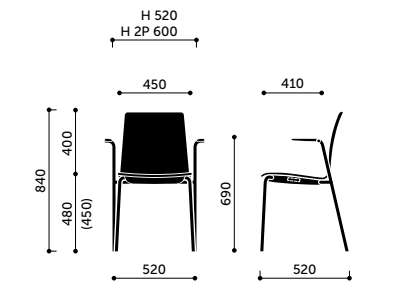

K12H / K12H 2P

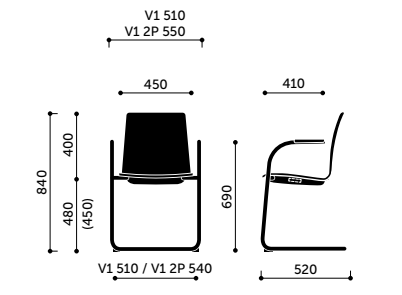
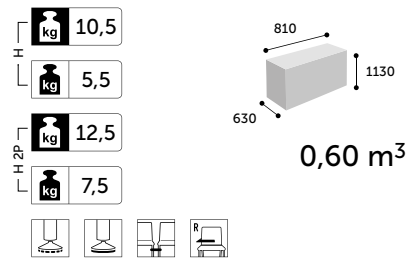

K12V1 / K12V1 2P

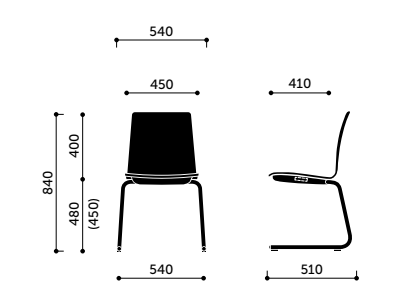
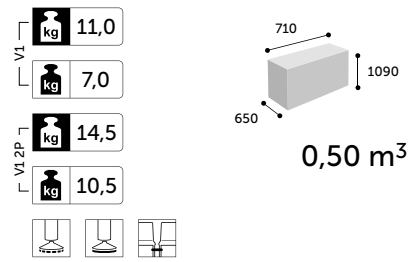

K12V2

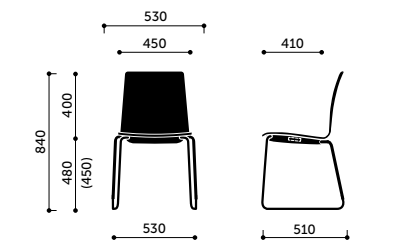
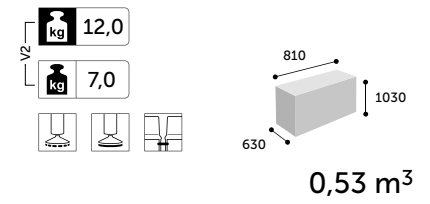

K12V

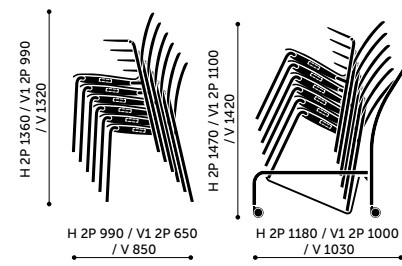
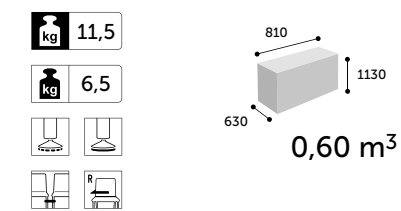

stacking K12

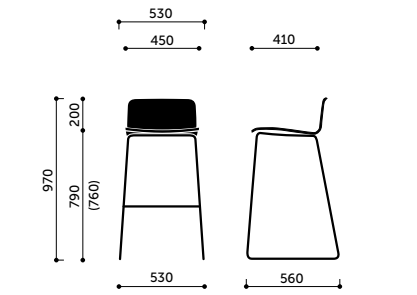
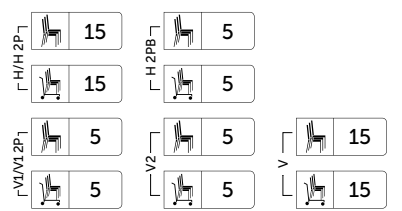

K12CV

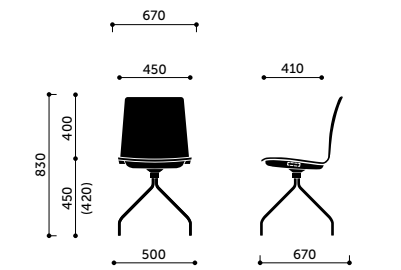
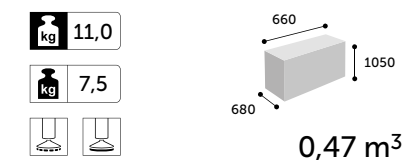

K12HF/HS

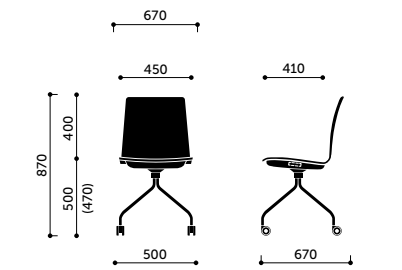
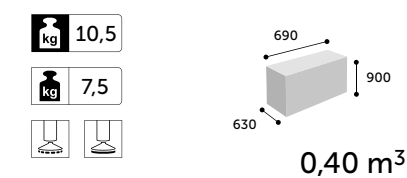

K12HC

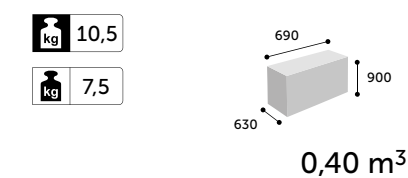

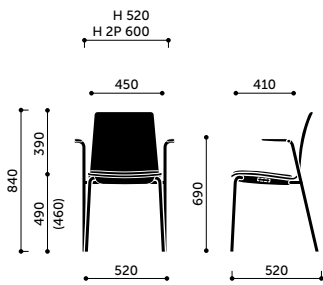

K22H / K22H 2P

- 11,0
- 6,0
- 13,0
- 8,0

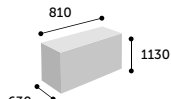

0,60 m³

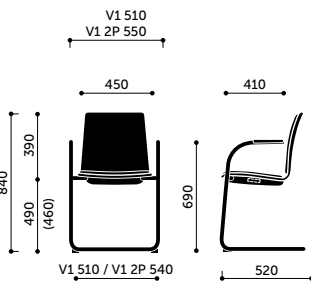

K22V1 / K22V1 2P

- 11,5
- 7,5
- 15,0
- 11,0

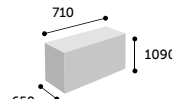

0,50 m³

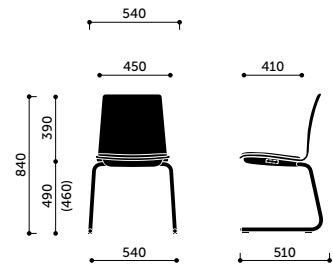

K22V2

- 12,5
- 7,5

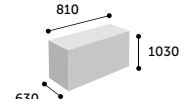

0,53 m³

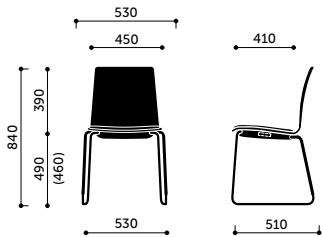

K22V

- 12,0
- 7,0

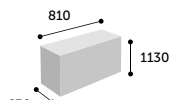

0,60 m³

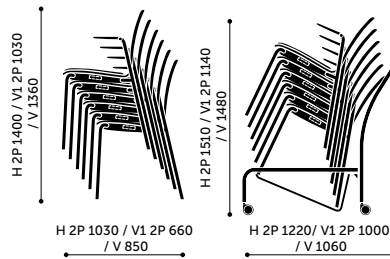

stacking K22

- 12
- 12
- 5
- 5
- 5
- 5
- 12
- 12

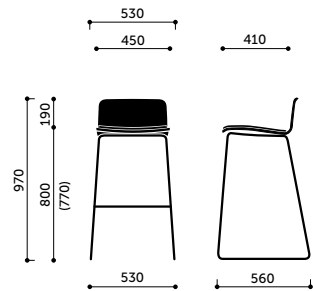

K22CV

- 11,5
- 8,0

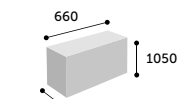

0,47 m³

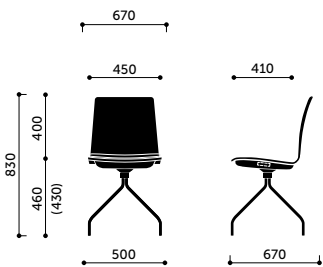

K22HF/HS

- 11,0
- 8,0

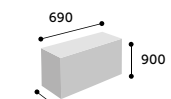

0,40 m³

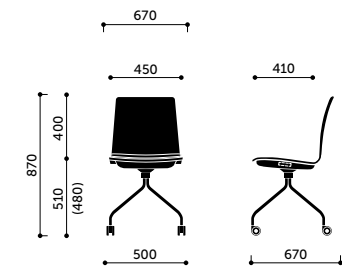

K22HC

- 11,0
- 8,0

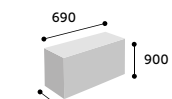

0,40 m³



Technical details

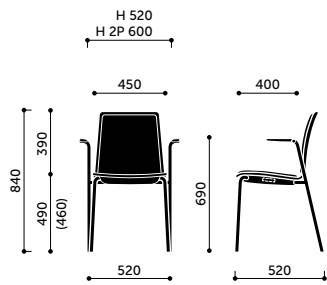

K32H / K32H 2P

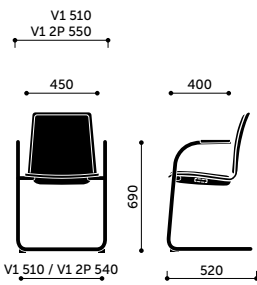
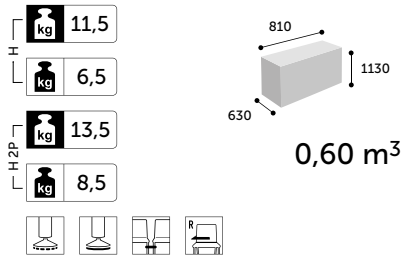

K32V1 / K32V1 2P

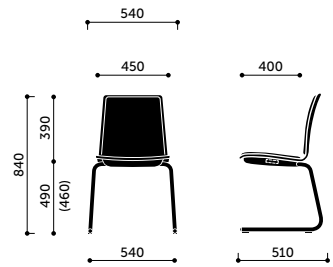
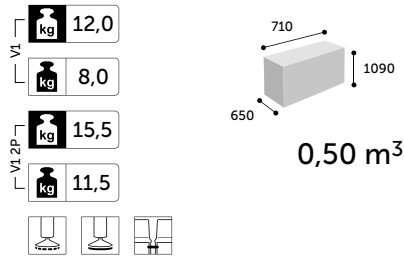

K32V2

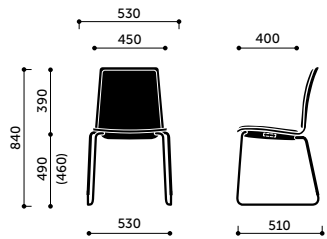
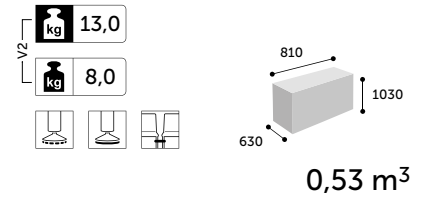

K32V

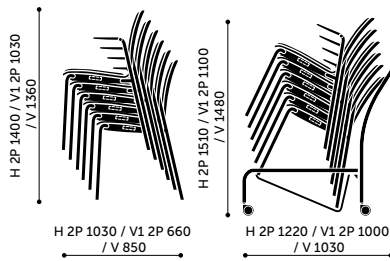
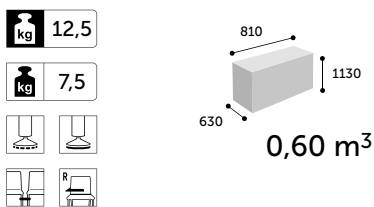

stacking K32

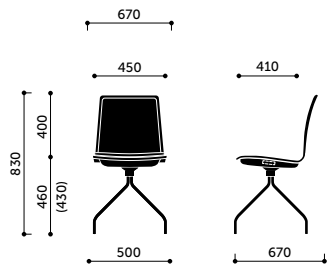
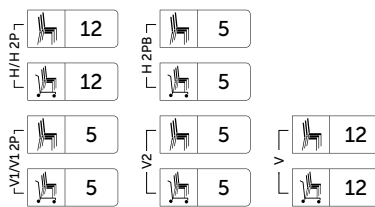

K32HF/HS

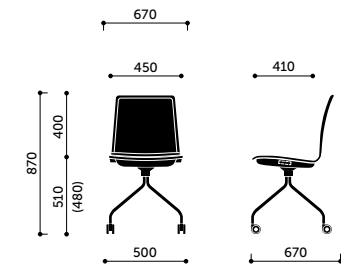
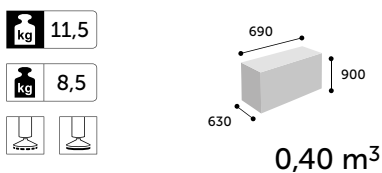

K32HC

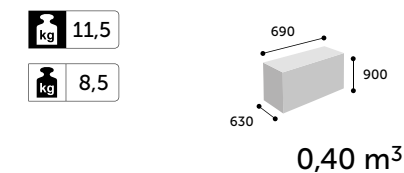

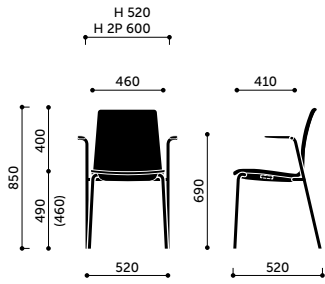

K42H / K42H 2P

- 11,0
- 6,0
- 13,0
- 8,0

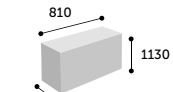

0,60 m³

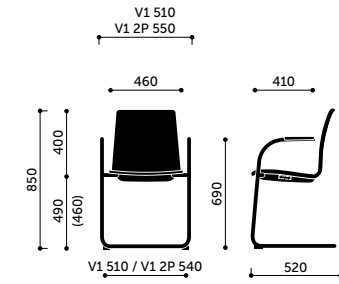

K42V1 / K42V1 2P

- 11,5
- 7,5
- 15,0
- 11,0

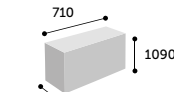

0,50 m³

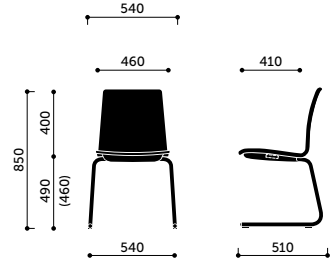

K42V2

- 12,5
- 7,5

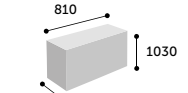

0,53 m³

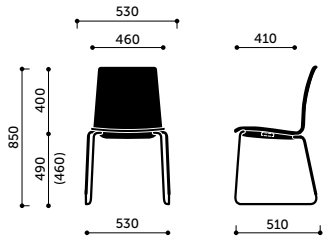

K42V

- 12,0
- 7,0

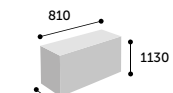

0,60 m³

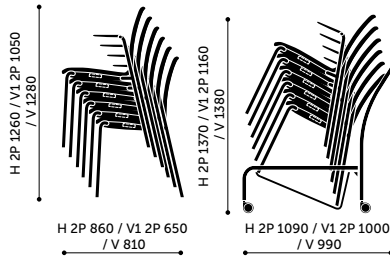

stacking K42

- 10
- 10
- 5
- 5
- 5
- 5
- 10
- 10

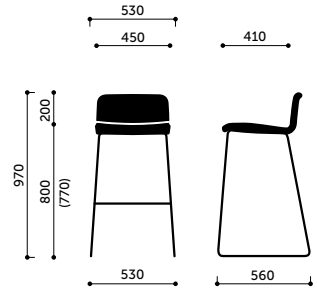

K42CV

- 11,5
- 8,0

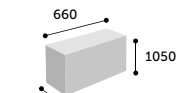

0,47 m³

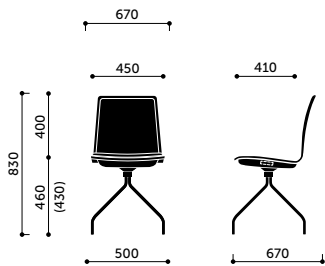

K32HF/HS

- 11,5
- 8,5

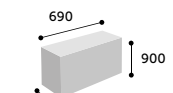

0,40 m³

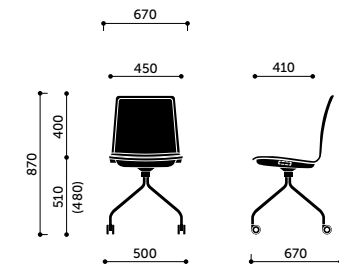

K32HC

- 11,5
- 8,5

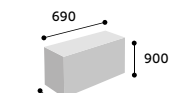

0,40 m³



Technical details

Ellie^{Pro}

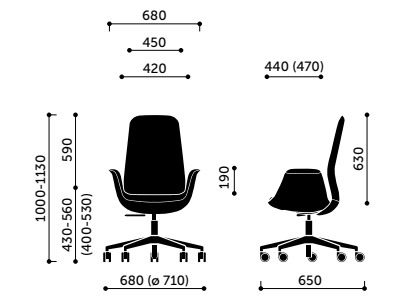

10ST

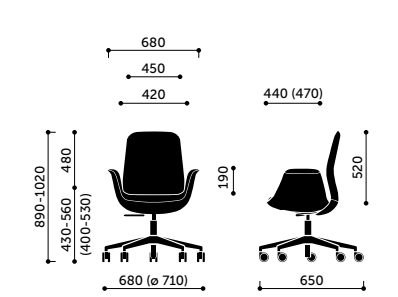

20ST

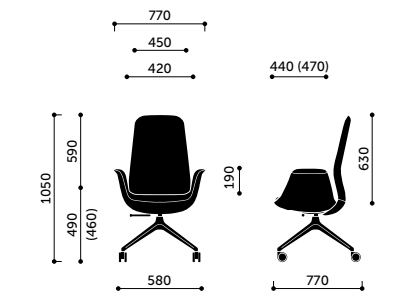

10HST

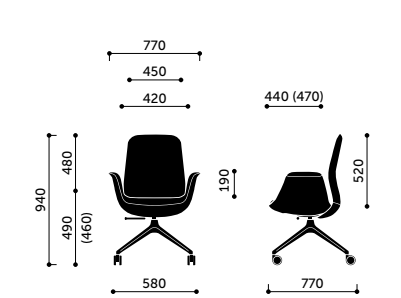
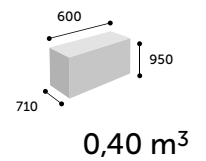
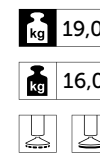
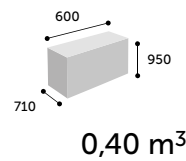
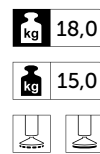
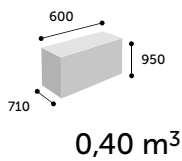
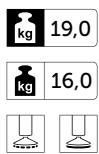

20HST

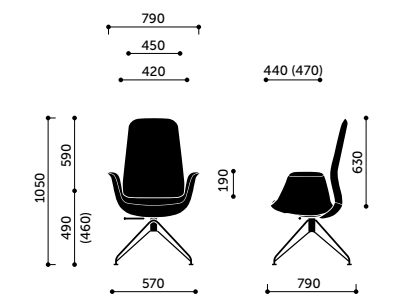

10V3

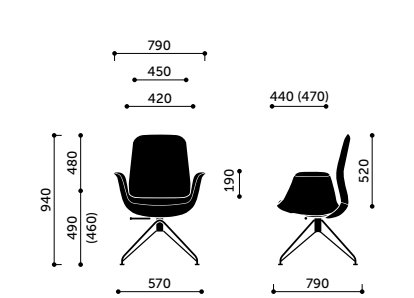

20V3

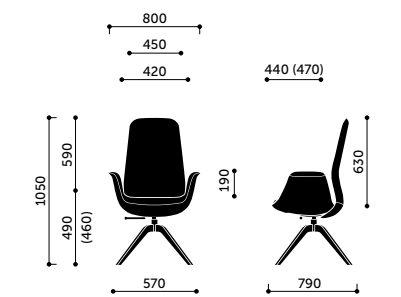
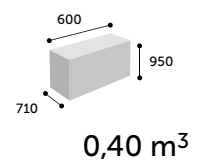
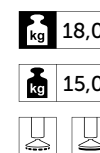
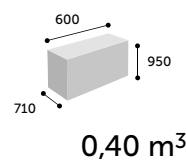
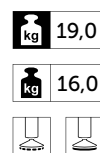
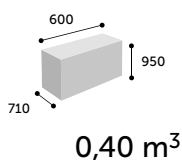
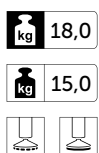

10HW

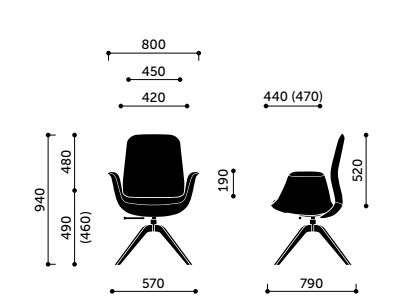

20HW

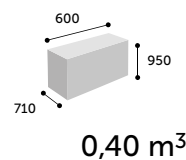
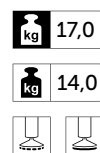
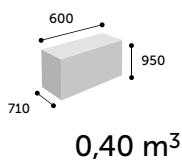
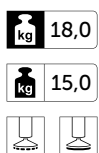

Eminent

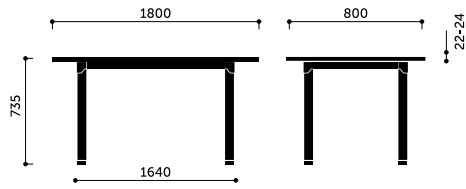

Eminent 4590-22

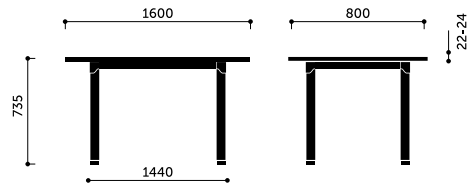

Eminent 4590-24

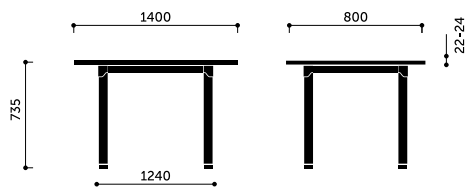

Eminent 4590-25

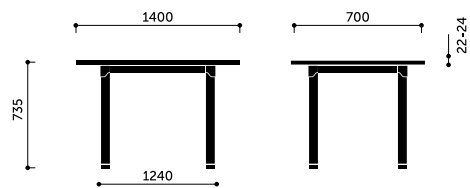

Eminent 4590-38

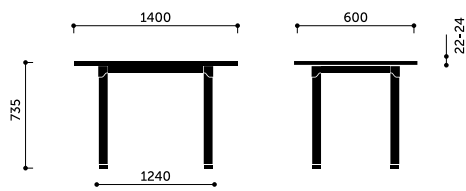

Eminent 4590-52

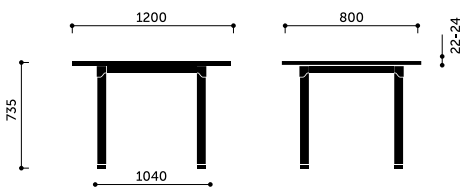

Eminent 4590-27

Technical details

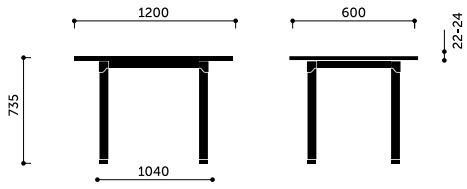

Eminent 4590-54

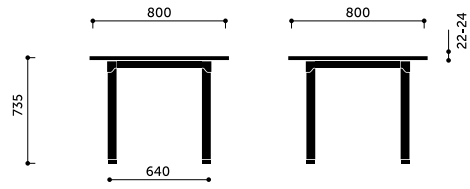

Eminent 4590-30

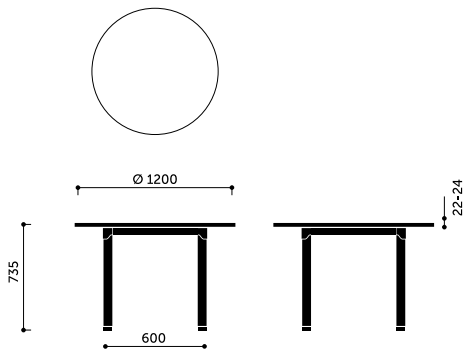

Eminent 4592-30

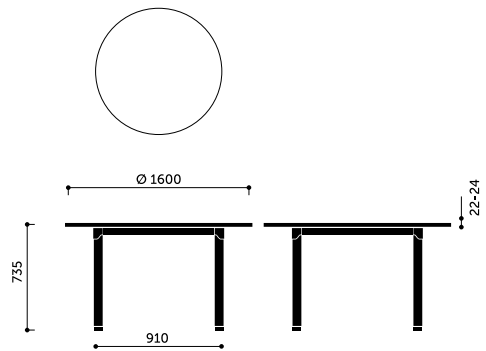

Eminent 4592-50

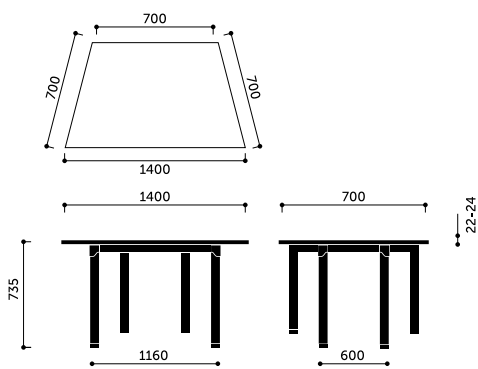

Eminent 4592-50

Fan

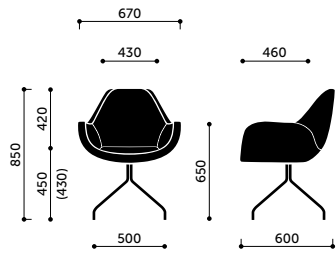

10H / 10HS

kg 13,5

kg 10,5

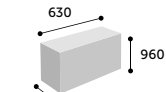

0,41 m³

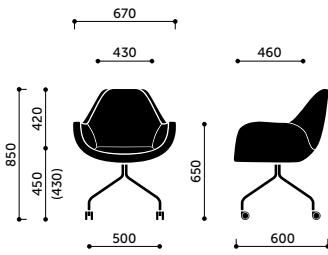

10HC

kg 13,5

kg 10,5

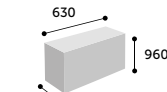

0,41 m³

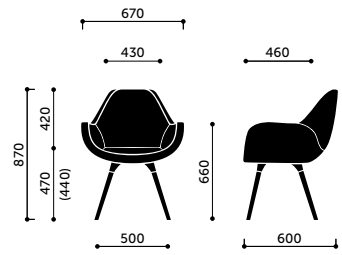

10HW

kg 12,5

kg 9,5

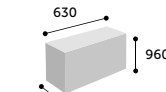

0,41 m³

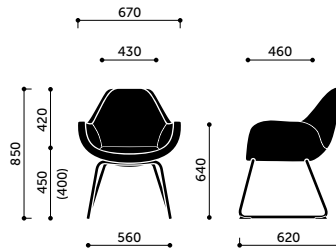

10V

kg 13,5

kg 10,5

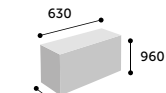

0,41 m³

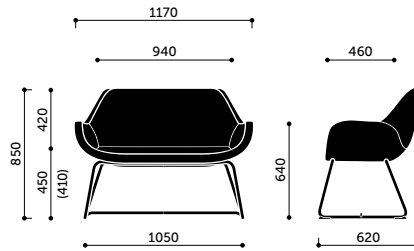

20V

kg 24,0

kg 17,0

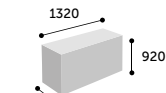

0,91 m³

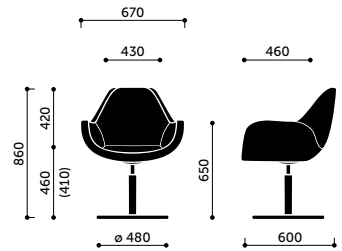

10R

kg 27,0

kg 23,0

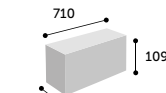
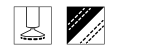

0,50 m³

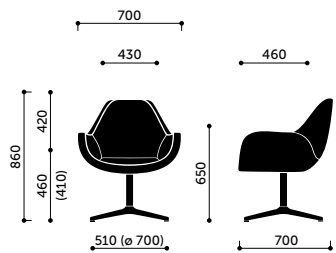

10F

kg 14,5

kg 11,5

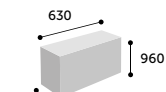

0,41 m³

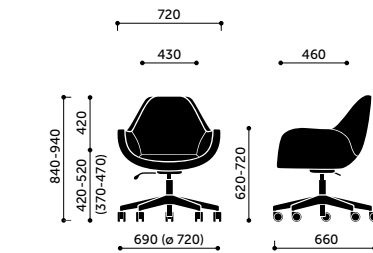

10Z

kg 16,5

kg 12,0

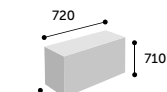

0,35 m³

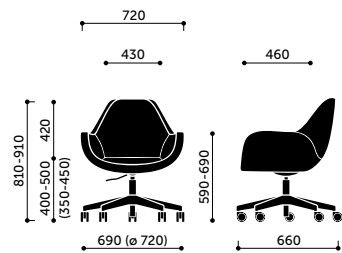

10E

kg 17,5

kg 13,0

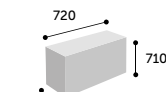

0,35 m³

Mickey

Technical details

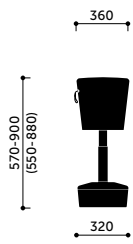

Mickey

 13,5

 11,5

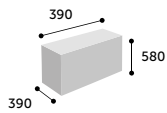

0,09 m³

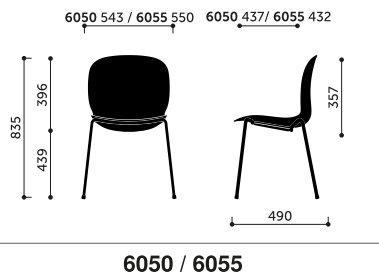

6050 / 6055

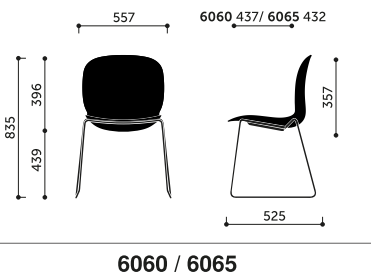

6060 / 6065

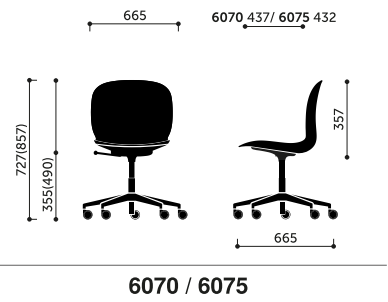

6070 / 6075

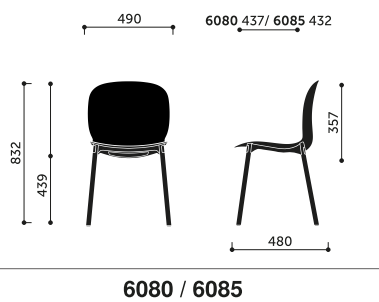

6080 / 6085

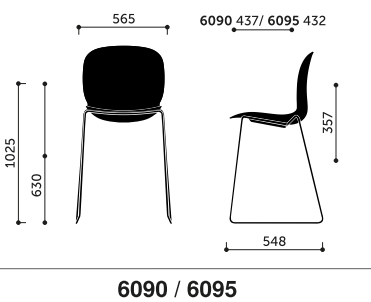

6090 / 6095

Technical details

Normo

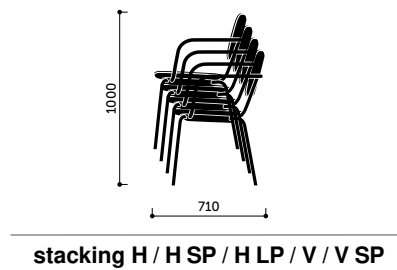
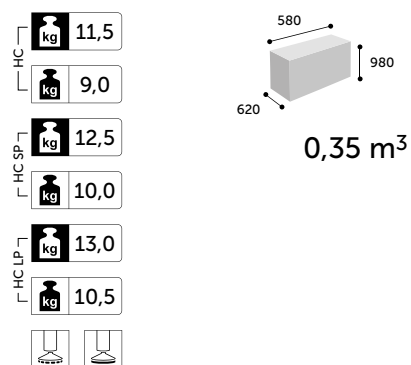
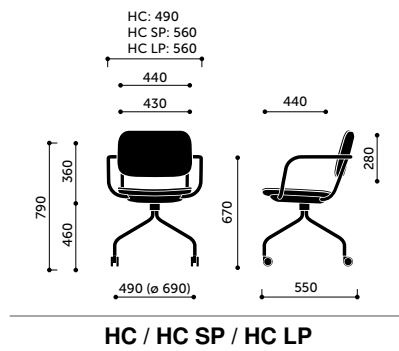
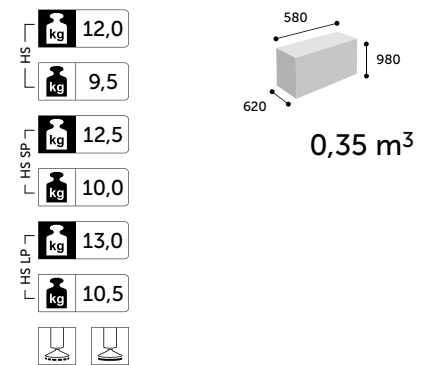
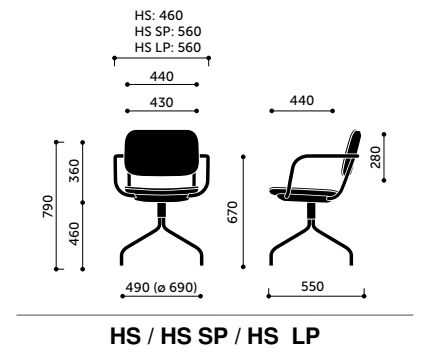
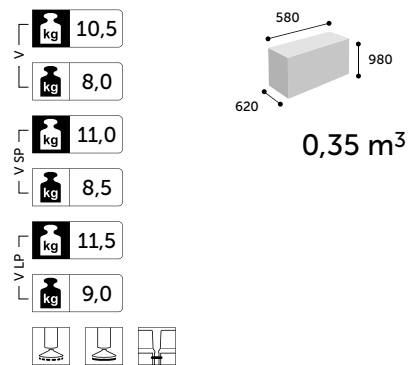
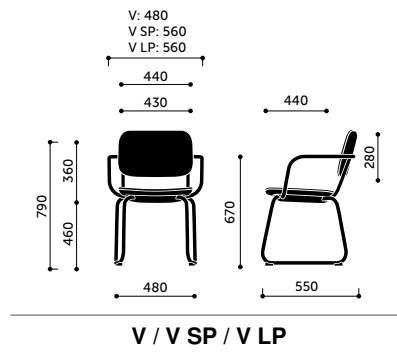
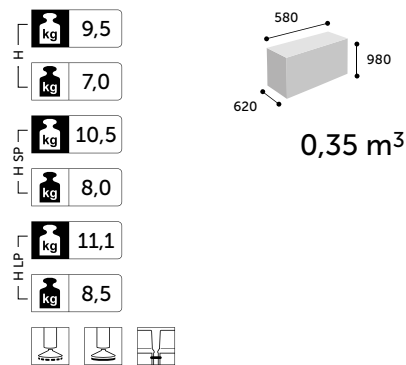
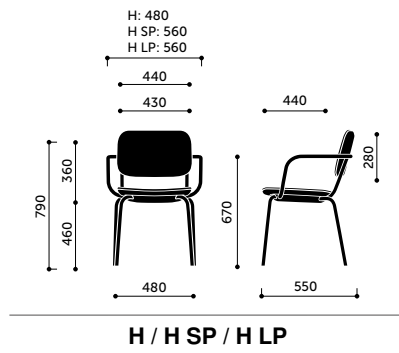

Nu

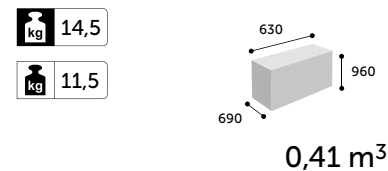
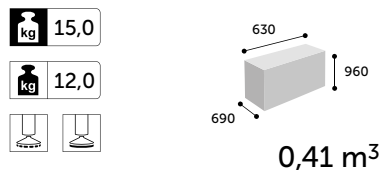
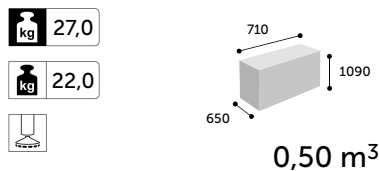
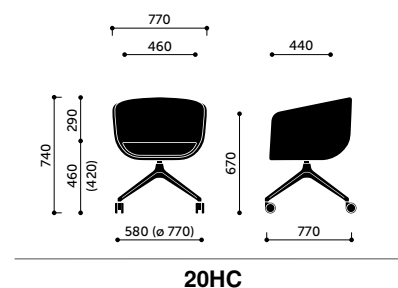
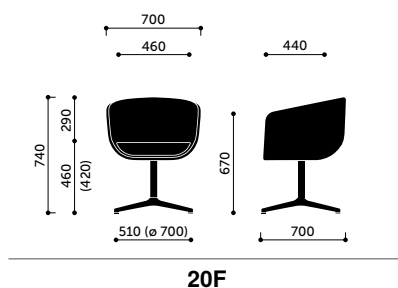
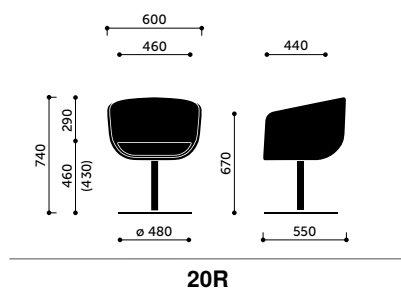
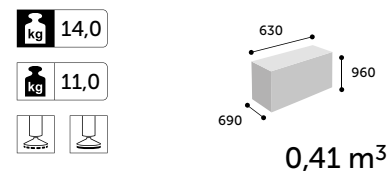
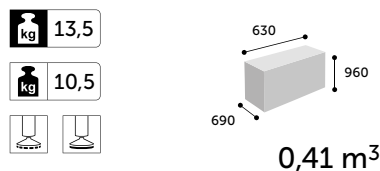
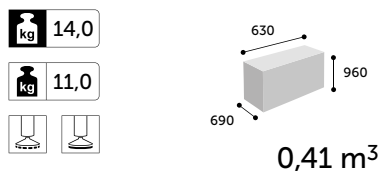
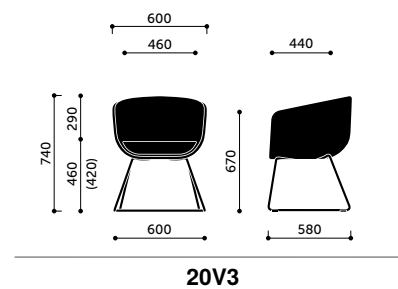
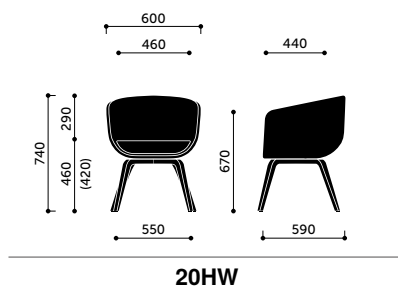
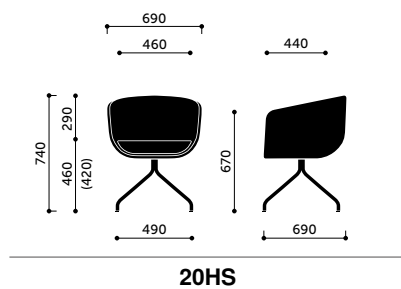

Revo

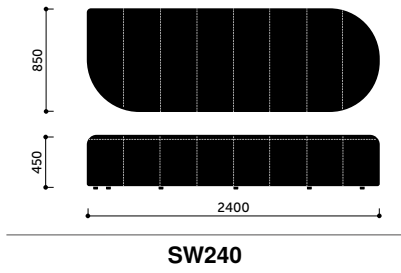

SW240

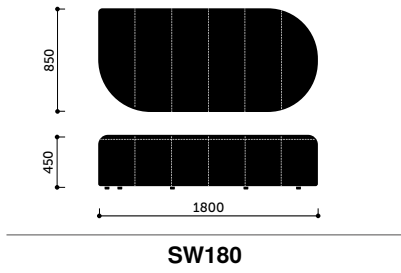

SW180

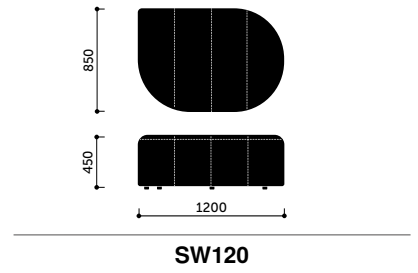

SW120

50,5
 42,0

1,10 m³

40,5
 34,0

0,85 m³

27,0
 21,0

0,60 m³

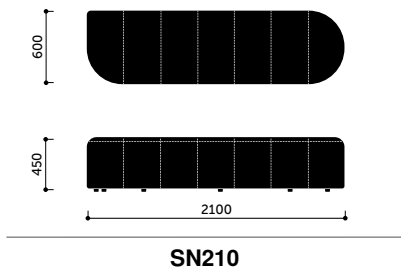

SN210

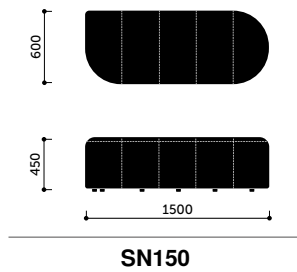

SN150

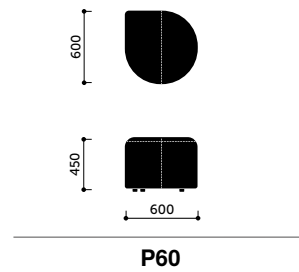

P60

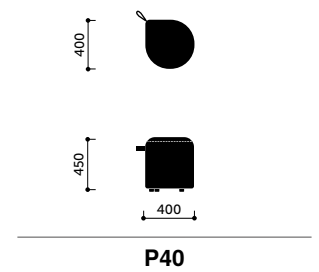

P40

34,0
 27,0

0,70 m³

23,5
 19,0

0,60 m³

8,5
 6,5

0,25m³

4,5
 3,5

0,12m³

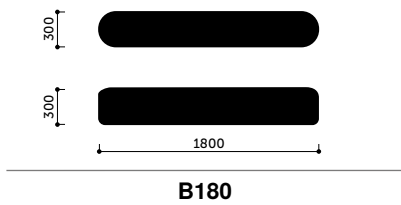

B180

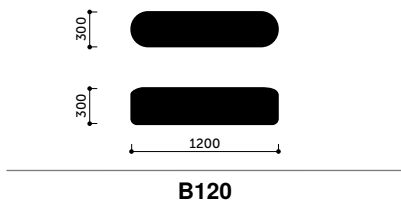

B120

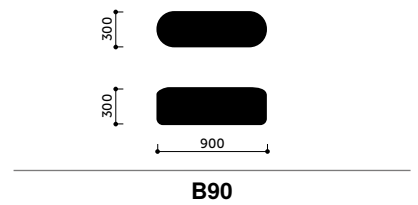

B90

14,0
 10,0

0,35 m³

11,5
 8,0

0,25 m³

8,0
 5,0

0,18m³

Technical details

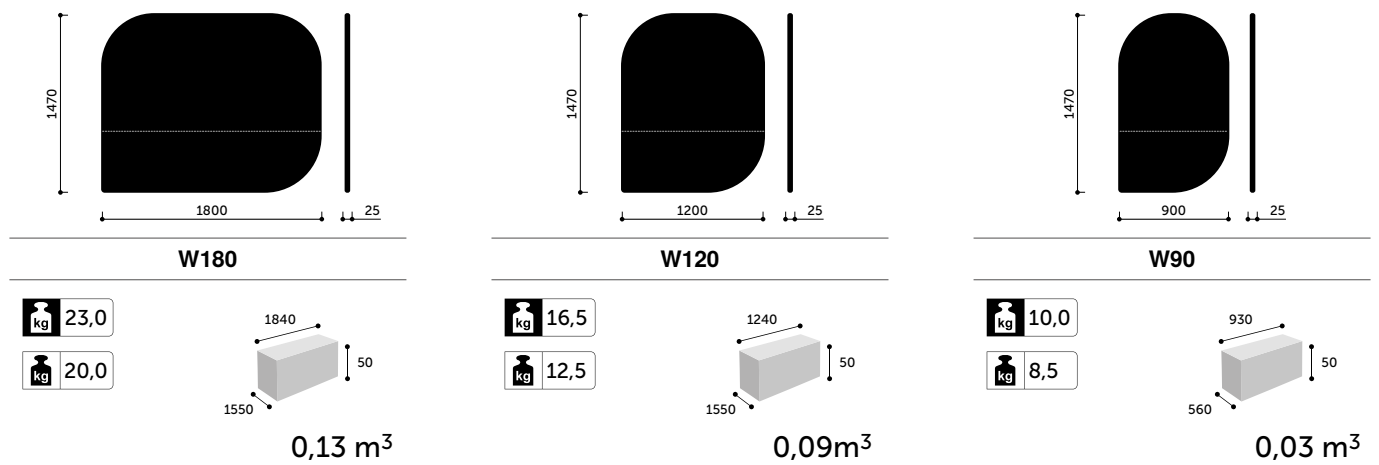

Revo Tables

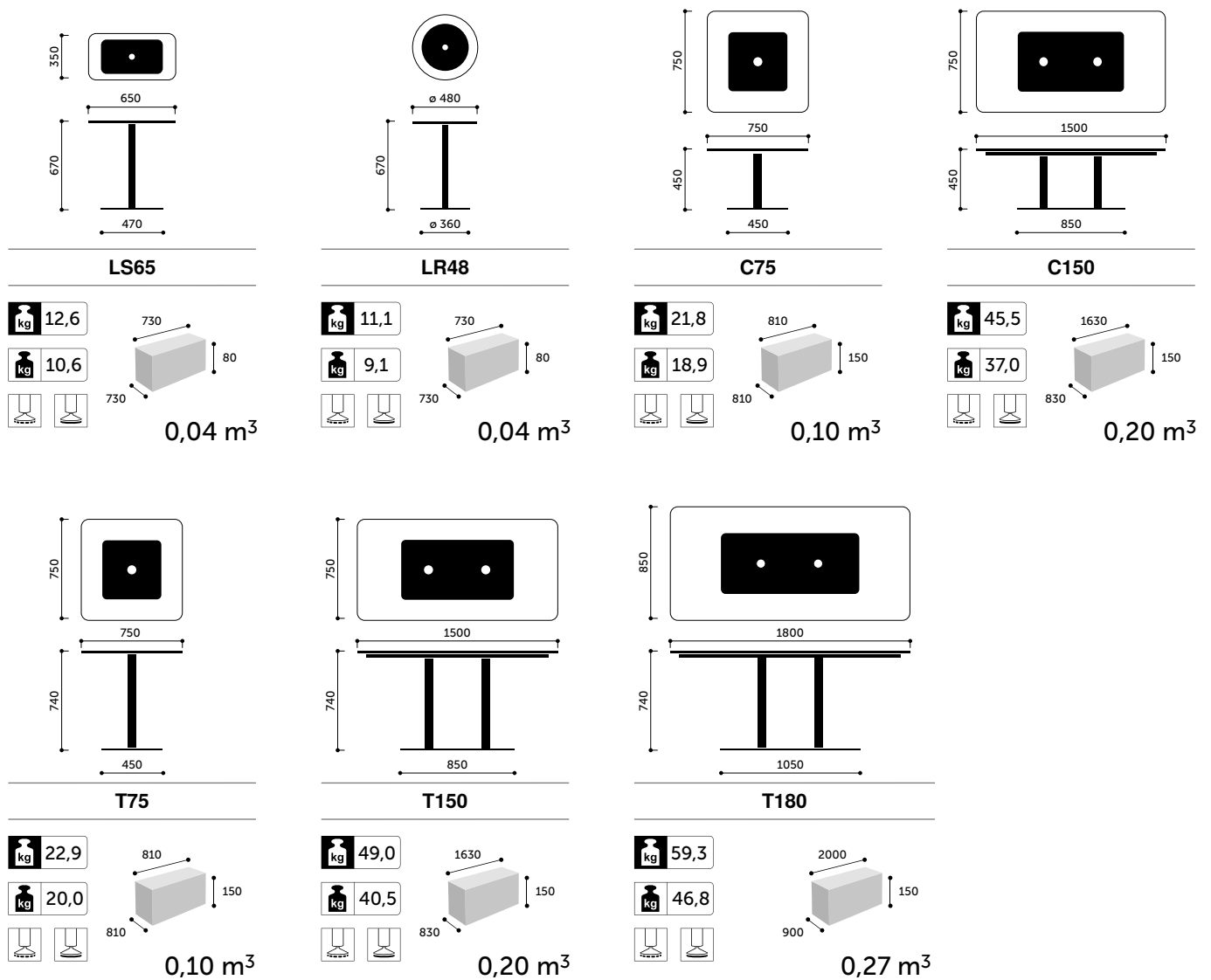

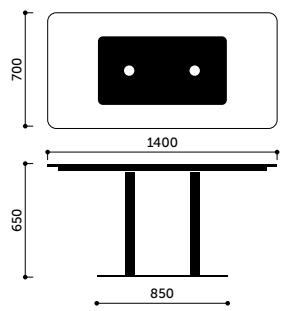

MT140

kg 47,5

kg 39,0

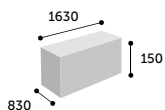

0,20 m³

Seven

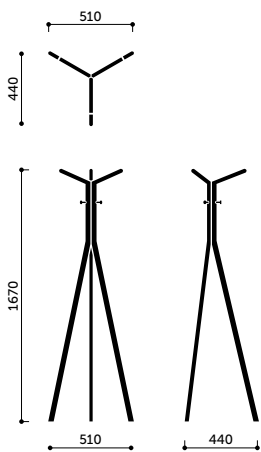

Seven

kg 6,0

kg 5,0

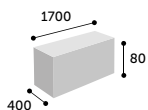

0,05 m³

Sorriso

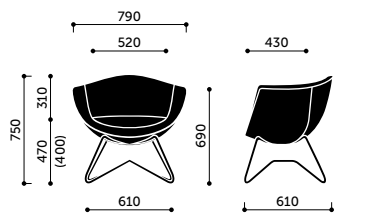

10V

 17,5

 13,5

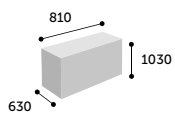

0,53 m³

Technical details

Standard Folding Table

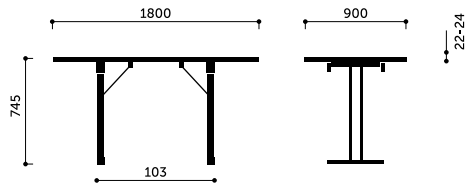

Standard Folding Table 4680-10

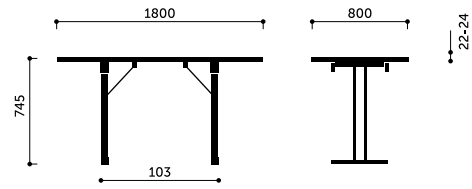

Standard Folding Table 4680-22

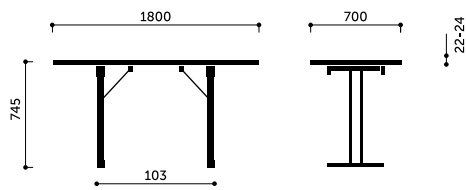

Standard Folding Table 4680-36

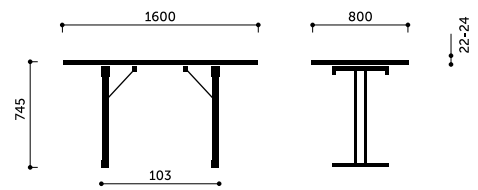

Standard Folding Table 4680-24

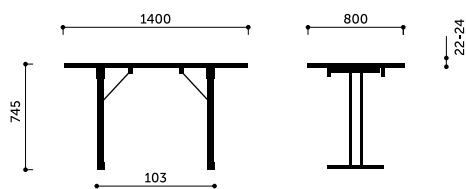

Standard Folding Table 4680-25

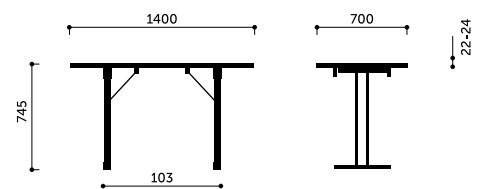

Standard Folding Table 4680-38

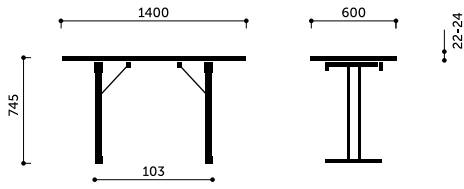

Standard Folding Table 4680-52

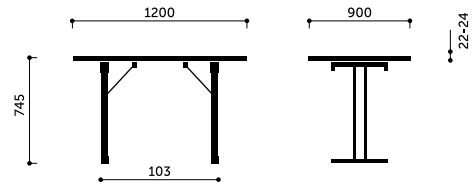

Standard Folding Table 4680-15

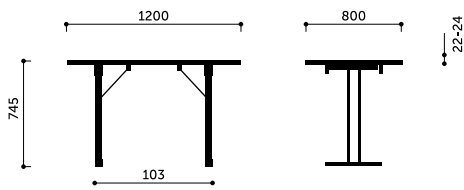

Standard Folding Table 4680-27

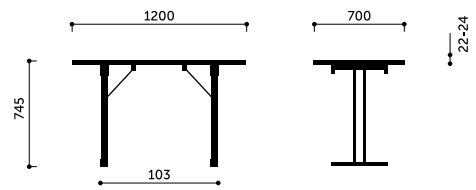

Standard Folding Table 4680-39

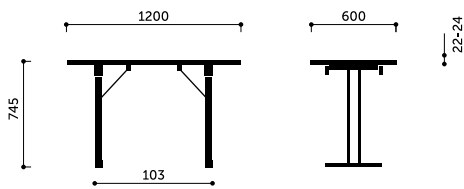

Standard Folding Table 4680-54

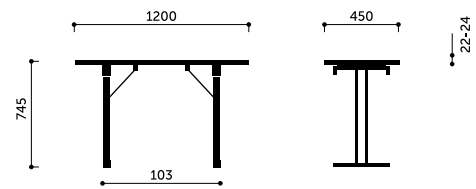

Standard Folding Table 4680-90

Technical details

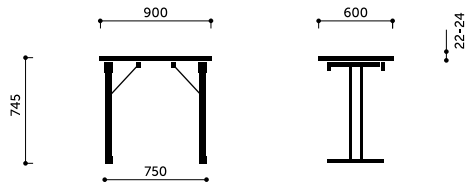

Standard Folding Table 4680-58

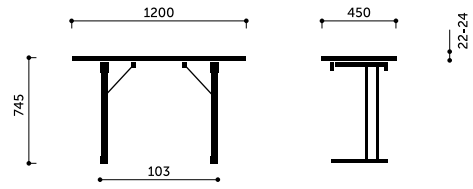

Standard Folding Table 4688-90

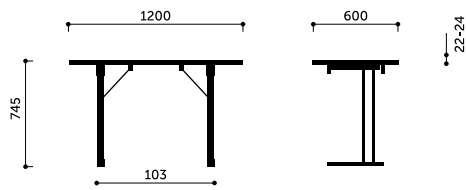

Standard Folding Table 4688-54

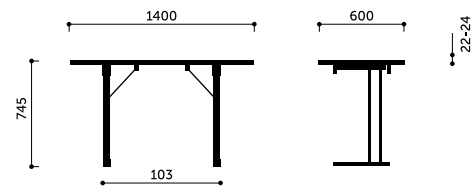

Standard Folding Table 4688-52

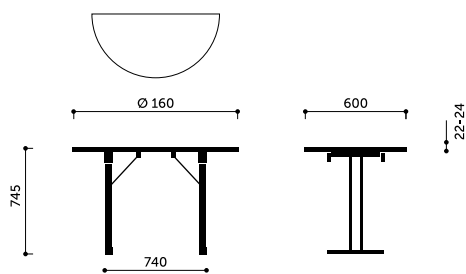

Standard Folding Table 4681-45

Technical details

Trillo^{Pro}

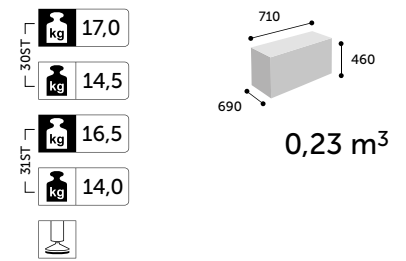
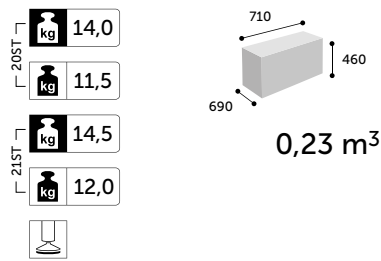
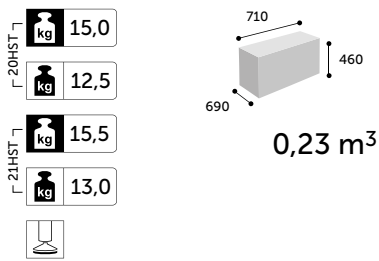
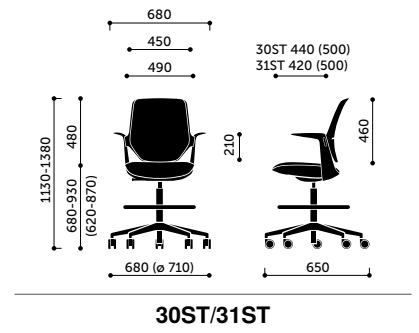
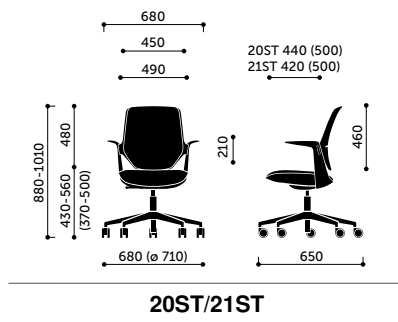
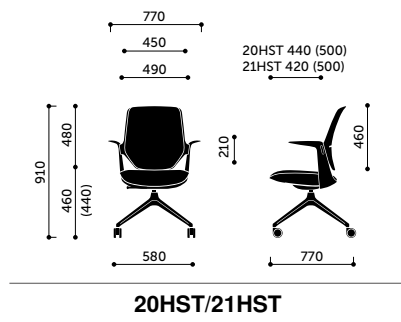

Trillo^{Pro}

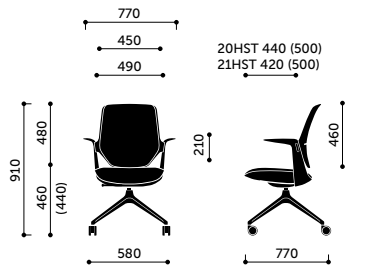

20HST/21HST

- 20HST 15,0 kg
- 20HST 12,5 kg
- 21HST 15,5 kg
- 21HST 13,0 kg

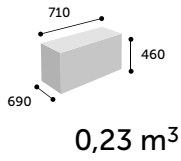

0,23 m³

u-Connect

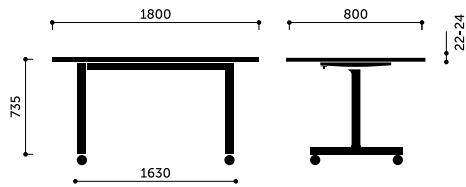

u-Connect 3490-22

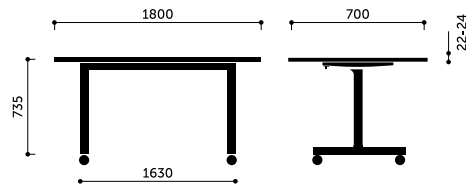

u-Connect 3490-36

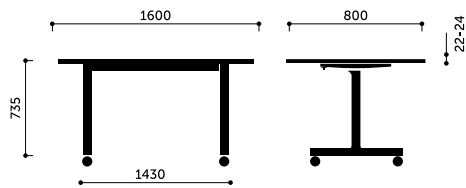

u-Connect 3490-24

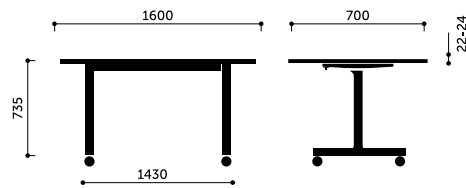

u-Connect 3490-37

Technical details

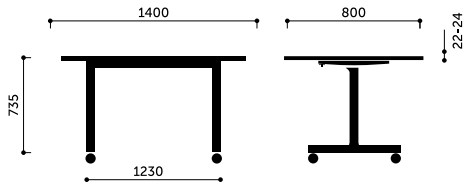

u-Connect 3490-25

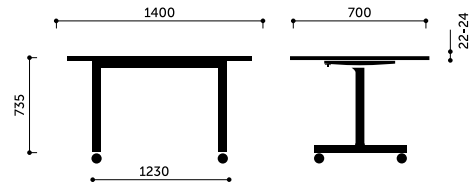

u-Connect 3490-38

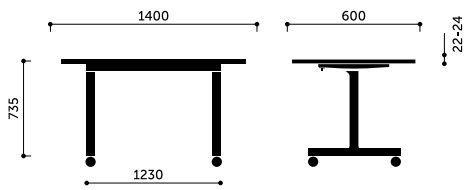

u-Connect 3490-52

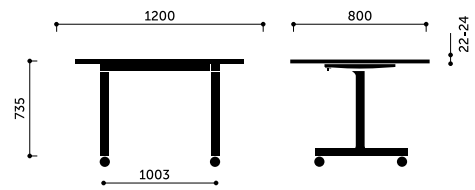

u-Connect 3490-27

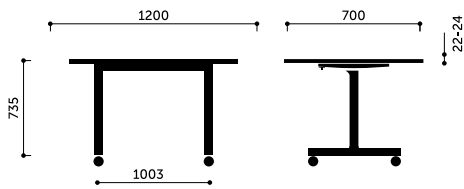

u-Connect 3490-39

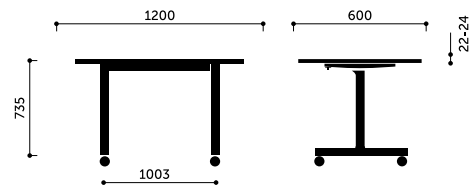

u-Connect 3490-54

Vancouver Lite

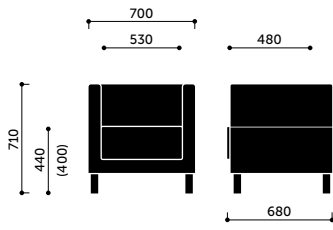

VL1 H / VL1 V

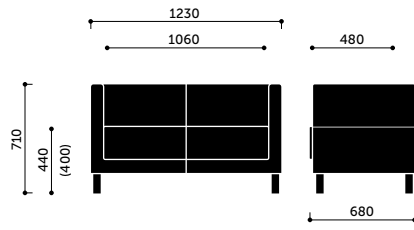

VL2 H / VL2 V

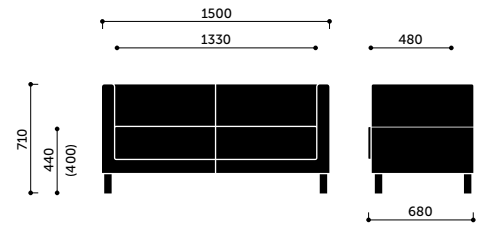

VL2,5 H / VL2,5 V

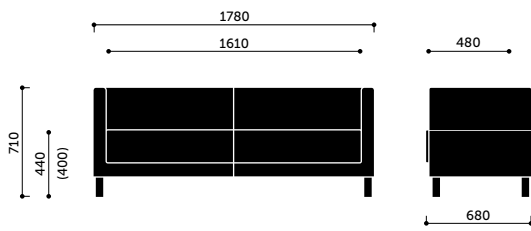
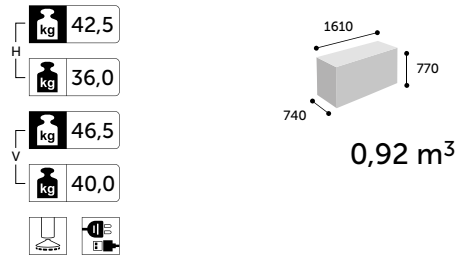
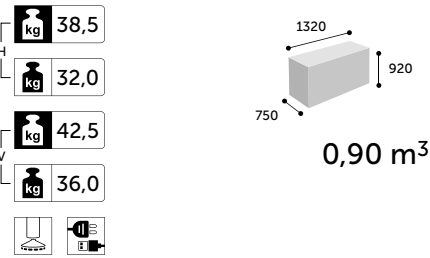
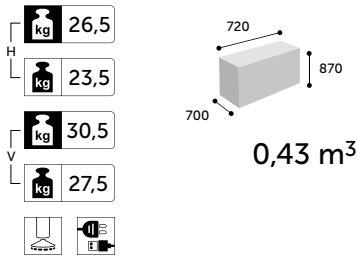

VL3 H / VL3 V

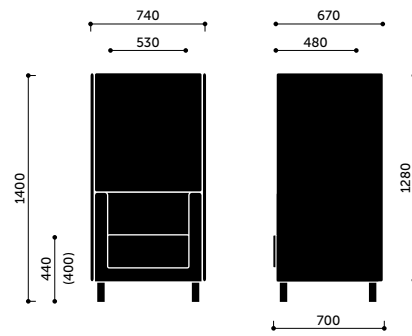

VL1 HW / VL1 VW + VL W1

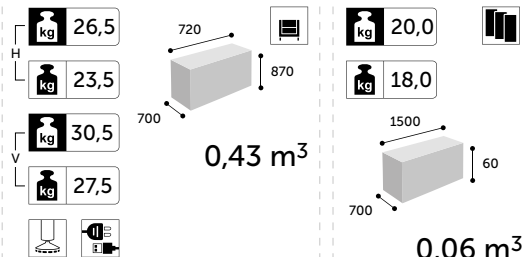

Technical details

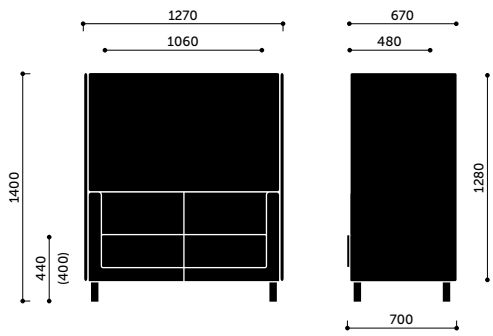

VL2 HW / VL2 VW + VL W2

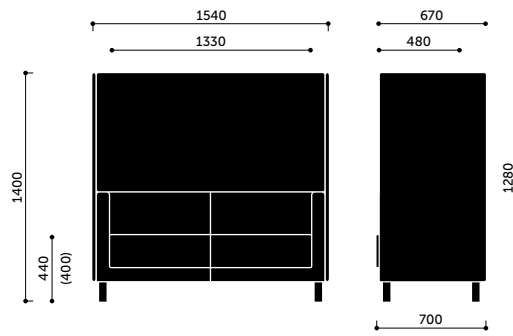

VL2,5 HW / VL2,5 VW + VL W2,5

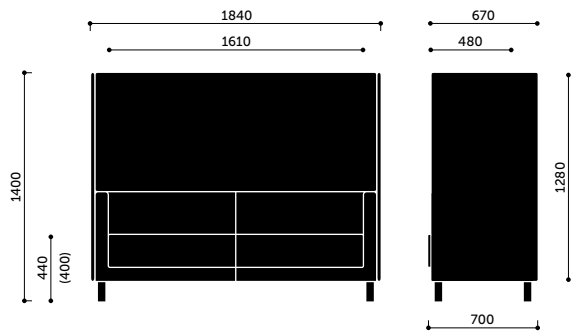
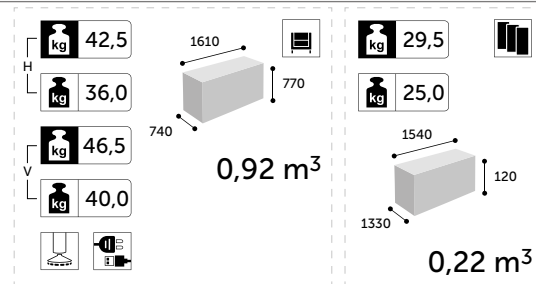
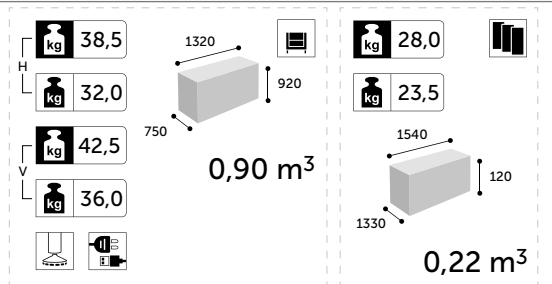

VL3 HW / VL3 VW + VL W3

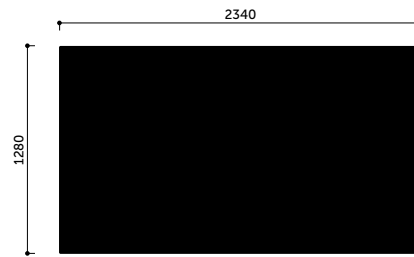

VL SW / VL SW HA

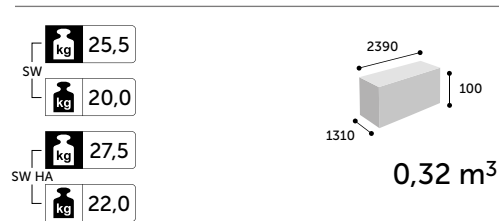
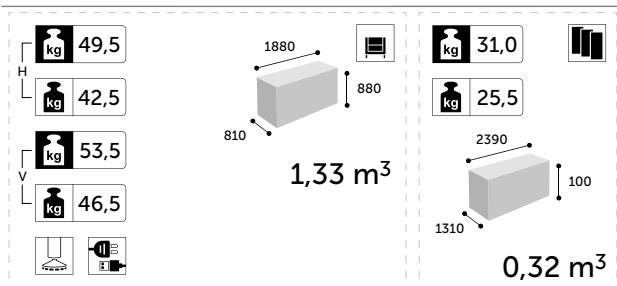

Vancouver Oto

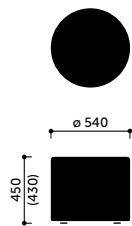

VOR1

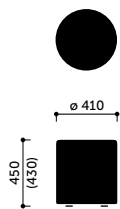
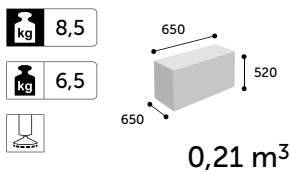

VOR2

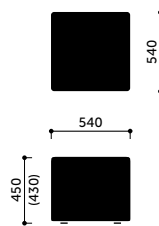
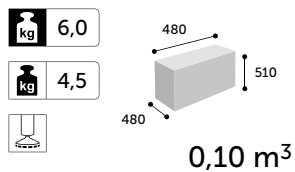

VOS1

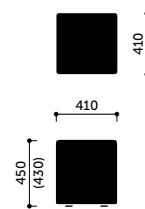
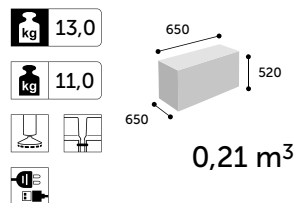

VOS2

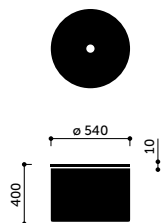
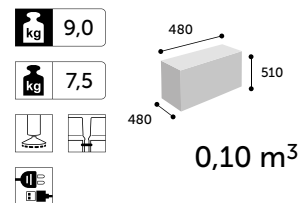

VOR1B

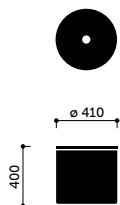
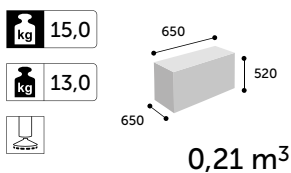

VOR2B

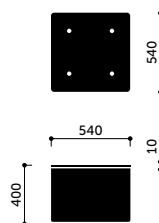
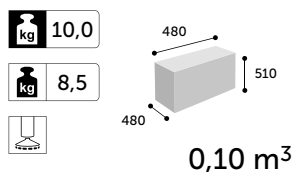

VOS1B

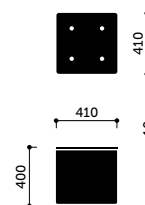
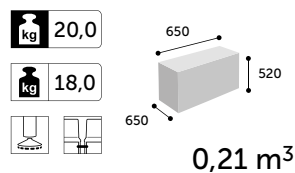

VOS2B

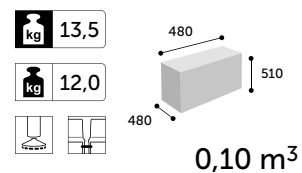

Wall In

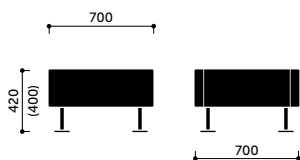

10 / 11 / 12 / 13

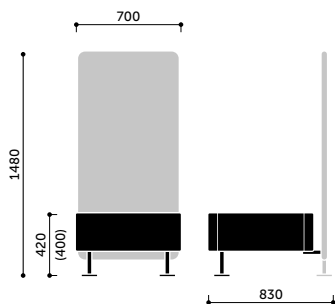
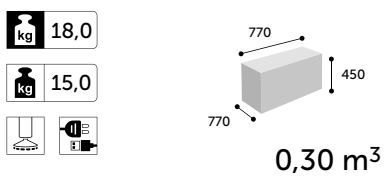

11 + W11

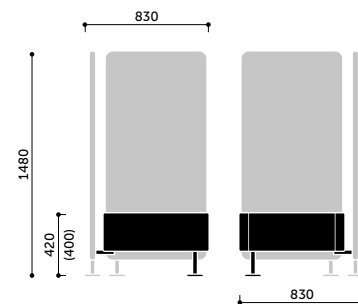

12 + 2xW11 (version I)

Technical details

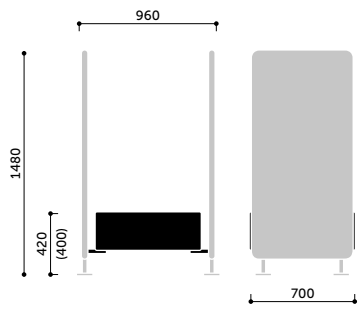

12 + 2xW11 (version II)

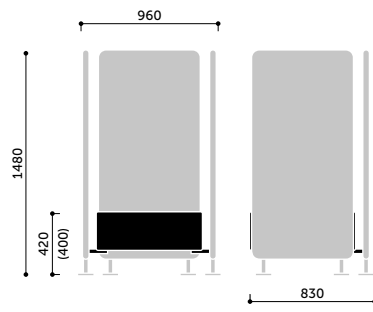

13 + 3xW11

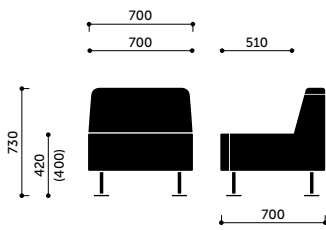

20 / 21 / 22 / 23

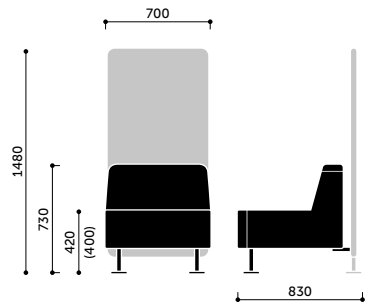

21 + W11

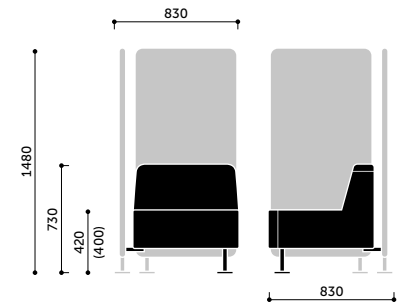

22 + 2xW11 (version I)

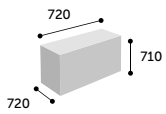
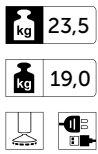

0,35 m³

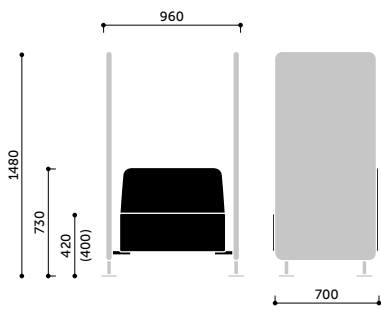

22 + 2xW11 (version II)

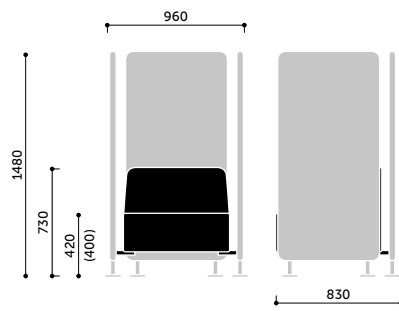

23 + 3xW11

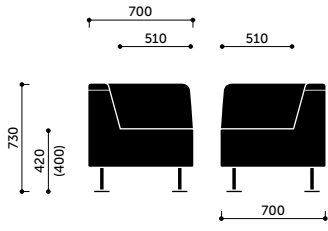

30 / 31 / 32

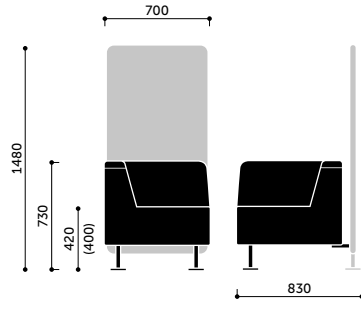

31

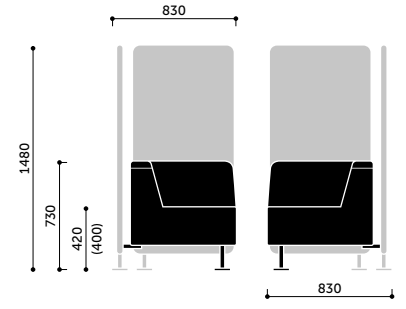

32

kg 24,5

kg 20,0

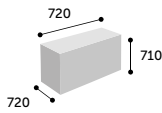

0,35 m³

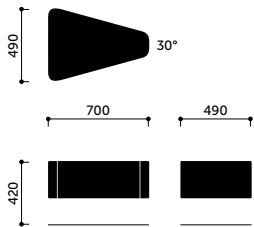

C1

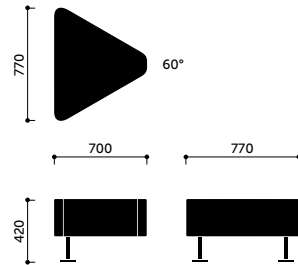

C2

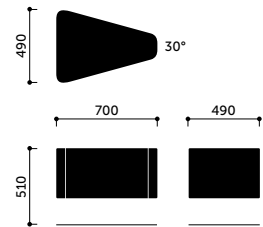

P1

kg 8,5

kg 7,0

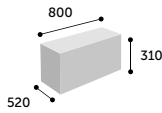

0,13 m³

kg 11,5

kg 9,0

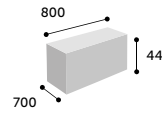

0,25 m³

kg 12,0

kg 9,5

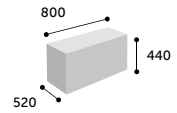

0,20 m³

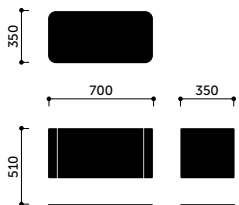

P3

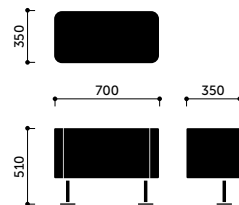

P4

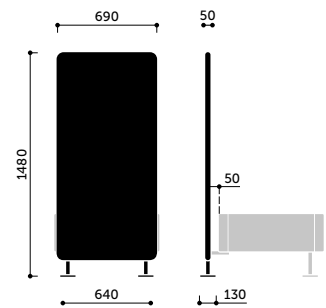

W11 / W12

kg 12,5

kg 10,0

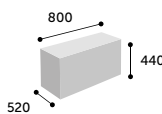

0,20 m³

kg 13,5

kg 11,0

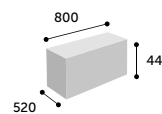

0,20 m³

kg 11,5

kg 9,5

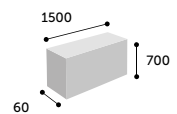

0,06 m³

Technical details

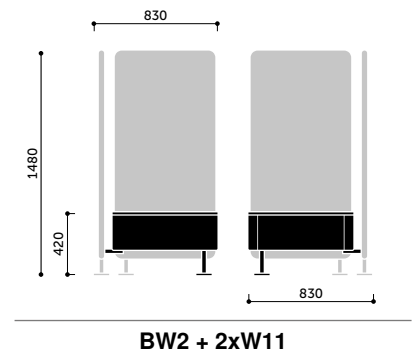
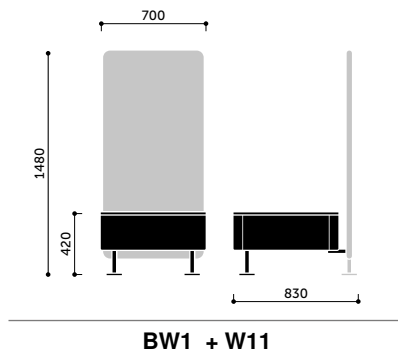
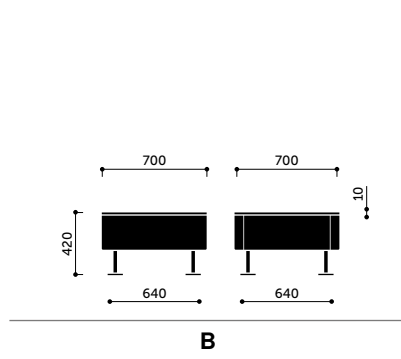

- 28,5
- 25,5
-

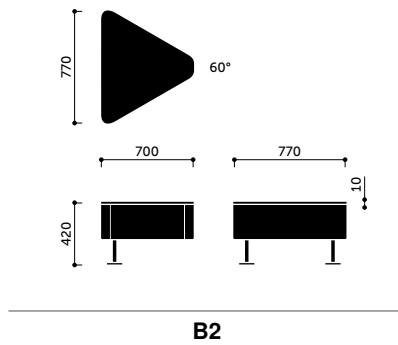
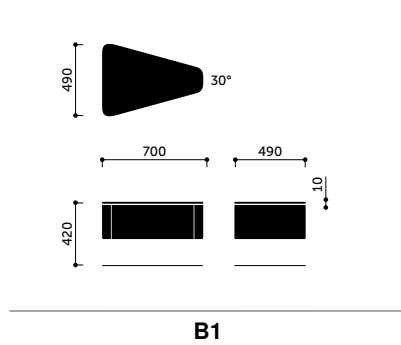
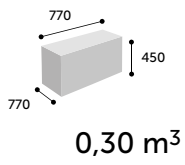

- 14,5
- 13,0
-

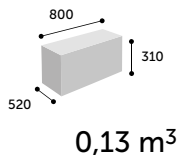

- 20,5
- 18,0
-

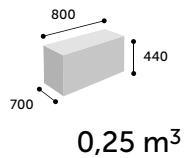

Zoo

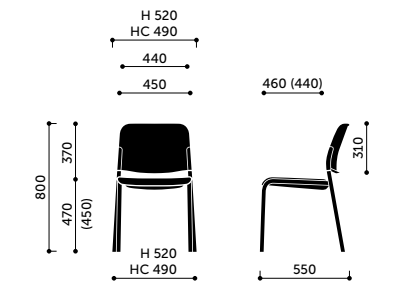

522H / 522HC

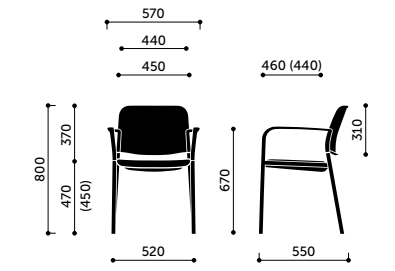
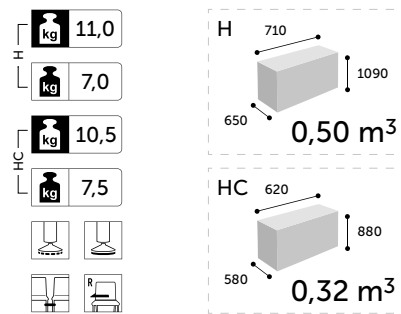

522H 2P / 522HC 2P

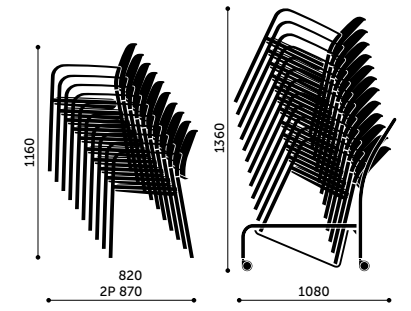
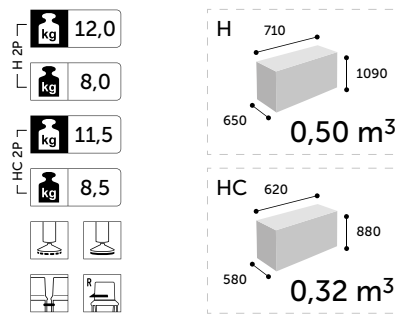

stacking 522H

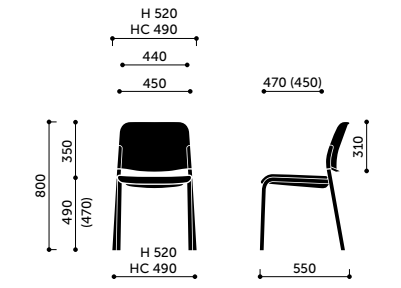
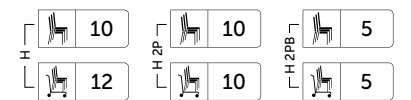

502H / 502HC

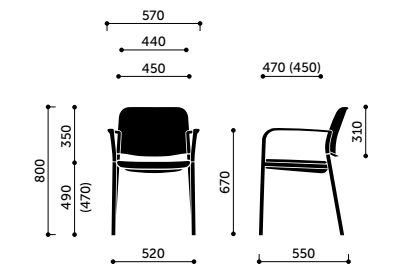
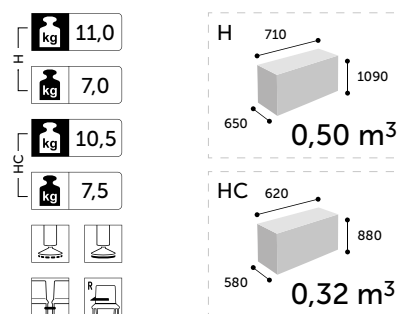

502H 2P / 502HC 2P

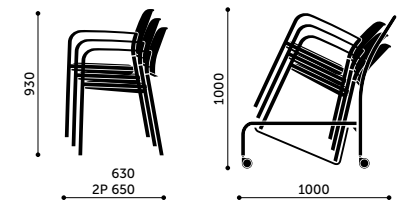

stacking 502H

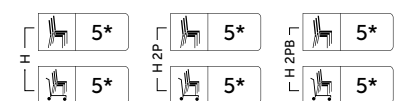

* chairs upholstered in Valencia: 3 pcs.

Technical details

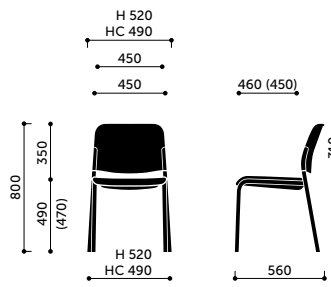

500H / 500HC

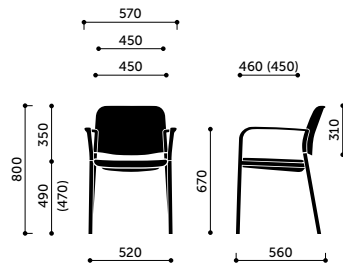

500H 2P / 500HC 2P

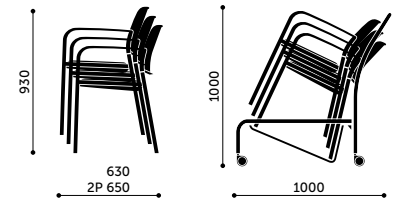

stacking 500H

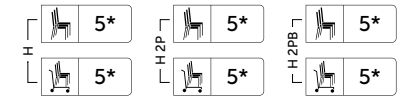
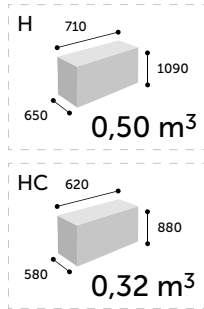
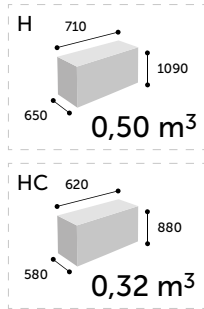
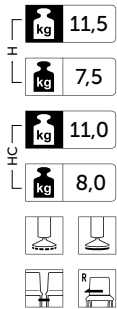

* chairs upholstered in Valencia: 3 pcs.

Castors / glides









Castors / glides	Models	Type	Castors / glides	Models	Type
	Ellie ^{Pro} , Noor, Trillo ^{Pro}	soft / hard (ø 65 mm)		Com V	felt / teflon
	Trillo ^{Pro} 30ST/31ST	soft / hard (ø 65 mm)		Chic H	felt / teflon
	Acos ^{Pro} 30VN	felt / teflon		Chic 20F, Fan 10F, Nu 20F	felt / teflon
	Acos ^{Pro} 30H	felt / teflon		Chic 20HW, Nu 20HW	felt / teflon
	Ariz - without armrests	felt / teflon		Ellie ^{Pro} 10HW, Ellie ^{Pro} 20HW	felt / teflon
	Ariz - with armrests	felt / teflon		Chic Lounge V3, Nu 20V3	felt / teflon
	Bit H	felt / teflon		Ellie ^{Pro} 10V3, Ellie ^{Pro} 20V3	felt / teflon
	Bit V, Zoo H	felt / teflon		Ellie ^{Pro} 10ST, Ellie ^{Pro} 20ST, Ellie ^{Pro} 10HST, Ellie ^{Pro} 20HST, Trillo ^{Pro} 20, Trillo ^{Pro} 21, Nu HC	teflon (ø 50 mm)
	Com H	felt / teflon		Fan 10H, Fan 10HS, Nu 20HS	felt / teflon
	Com V1	felt / teflon		Fan 10HW	felt / teflon
	Com V2	felt / teflon		Fan 10V, Fan 20V	felt / teflon
	Ana	felt / hard			

Castors / glides





Castors / glides	Models	Type
	Fan 10HC, Fan 10Z, Fan 10E, Nu 20HC	Universal (ø 65 mm)
	Com HC, Normo HC	Universal (ø 55 mm)
	Fan 10Z, Fan 10E	teflon
	Sorriso 10V	felt / teflon
	Noor 6090/6095	felt / hard
	Noor 6060/6065	felt / hard
	Noor 6050/6055	felt / hard
	Noor 6080/6085	felt / hard

Castors are equipped with a brake that prevents the chair from "moving away" without a load.
In models LightUp 330ST/350ST and Trillo[®] 30ST/31ST castors are equipped with a reverse brake that prevents the chair from "moving away" with a load.

Bases

Base	Applied to the models	Colour	Type of material	Diameter (mm)
	Ellie ^{Pro} 10HST, Ellie ^{Pro} 20HST, Trillo ^{Pro} 20HST, Trillo ^{Pro} 21HST, Nu HC	black	aluminium powder coated aluminum	770
	Ellie ^{Pro} 10HST, Ellie ^{Pro} 20HST, Trillo ^{Pro} 20HST, Trillo ^{Pro} 21HST, Nu HC	white	powder coated aluminum	770
	Ellie ^{Pro} 10HST, Ellie ^{Pro} 20HST, Trillo ^{Pro} 20HST, Trillo ^{Pro} 21HST, Nu HC	graphite	powder coated aluminum	770
	Ellie ^{Pro} 10HST, Ellie ^{Pro} 20HST, Trillo ^{Pro} 20HST, Trillo ^{Pro} 21HST, Nu HC	polished aluminum	aluminium	770
	Ellie ^{Pro} 10ST, Ellie ^{Pro} 20ST	black	plastic - polyamide	710
	Ellie ^{Pro} 10ST, Ellie ^{Pro} 20ST	light grey	plastic - polyamide	710
	Noor 6070, Noor 6075	polished aluminum	aluminium	665
	Noor 6070, Noor 6075	black	aluminium	665
	Noor 6070, Noor 6075	white	aluminium	665

Bases

Base	Applied to the models	Colour	Type of material	Diameter (mm)
	Fan	black	plastic - polyamide	720
	Fan	MetallicPro	powder coated aluminum	720
	Fan	polished aluminum	aluminum	720
	Sorriso 10F	polished aluminum	aluminium	760
	Fan 10F, Nu 20F	polished aluminum	aluminium	700

Mechanisms



Rocker

Fan 10Z

A - Seat height
B - Tilt angle of the backrest and the seat



Economic

Fan 10E

A - Seat height



Economic

Noor 6070/6075

A - Seat height



Synchro Self*

Trillo^{Pro}, Ellie^{Pro}

A - Seat height
B - Tilt angle of the backrest and the seat



Synchro Self*

Trillo^{Pro}, Ellie^{Pro}

A - Tilt angle of the backrest and the seat



Rocker

MyTurn 10FZ, 20FZ

A - Seat height (only in Z models)
B - Tilt angle of the backrest and the seat

The Synchro mechanisms used in Profim products are equipped with Anti-Shock system after releasing the mechanism, the back does not hit the sitting person, but remains in the previous position. The Synchro mechanism is activated only when the person leans on the backrest again.

Linking parts

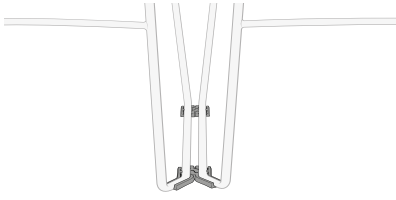

Linking part Ariz

Price - no extra charge.

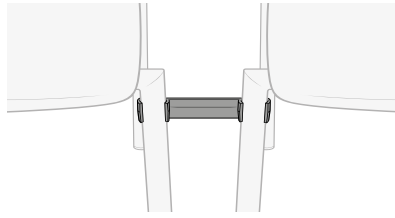

Universal FIXED 1 Linking part

Available in models without armrests: Bit.

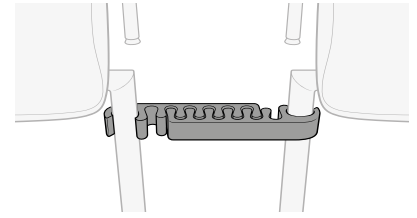

Universal ADJUSTABLE Linking part

Available in Bit without armrests.
Available in Com.

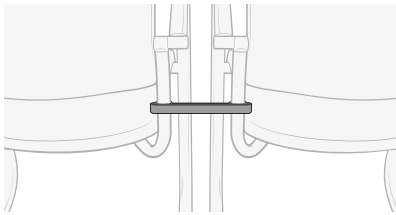

Universal FIXED 2 Linking part

Available in models: Acos^{PRO}.

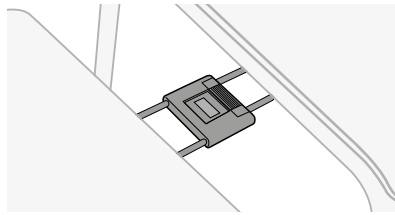

Linking part Com, Zoo

Available in 4-legged Com and Zoo.

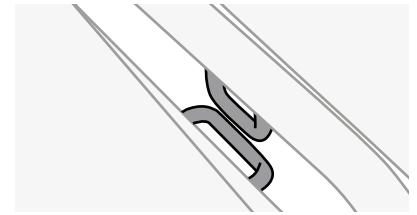

Linking part Ana

Available in Ana.

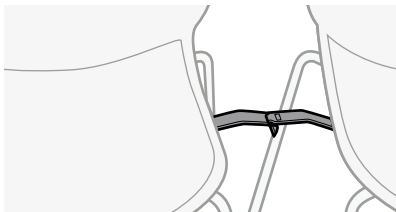

Linking part Noor

Available in Noor.

Stacking

	Maximum quantity in stack (pc.)	Maximum quantity in stack on trolley (pc.)
Acos^{Pro}		
30V	2	-
Ana		
4340	12	-
4340S	10	-
4340SR	7	-
Ariz		
550V, 555V	15	45
550V 2P, 555V 2P	10	45
560V, 560V 2P	5	20
570V, 570V 2P	5	20
575V, 575V 2P	5	20
550CV	2	-
555CV	2	-
560CV	2	-
570CV	2	-
575CV	2	-
Bit		
550H, 550H 2P	5	-
555H, 555H 2P	5	-
560H, 560H 2P	3	-
570H, 570H 2P	3	-
575H, 575H 2P	3	-
550V, 550V 2P	3	-
555V, 555V 2P	3	-
560V, 560V 2P	3	-
570V, 570V 2P	3	-
575V, 575V 2P	3	-
Com		
12H (+2P)	15	15
12H 2PB	5	5
12V1 (+2P)	5	5
12V2	5	5
12V	15	15
22H (+2P)	12	12
22H 2PB	5	5
22V1 (+2P)	5	5
22V2	5	5
22V	12	12
32H (+2P)	12	12
32H 2PB	5	5

	Maximum quantity in stack (pc.)	Maximum quantity in stack on trolley (pc.)
32V1 (+2P)	5	5
32V2	5	5
32V	12	12
42H (+2P)	10	10
42H 2PB	5	5
42V1 (+2P)	5	5
42V2	5	5
42V	10	10
Noor		
4-leg 6050/6055	10	-
4-leg 6050/6055 with armrests	10	-
4-leg 6060/6065	5	-
4-leg 6060/6065 with armrests	5	-
Normo		
H, H LP, H SP	4	-
V, V SP	4	-
Zoo		
522H	10	12
522H 2P	10	10
522H 2PB	5	5
502H, 502H 2P, 502H 2PB	5*	5*
500H, 500H 2P, 500H 2PB	5*	5*

* Chairs upholstered in Valencia - 3 pcs.

Glides, table tops, joining in rows

	Joining in rows	Felt glides (for hard surfaces)	Teflon glides (universal)	Left-sided table top	Right-sided table top
Ana	•	•		•	•
Ariz	•	•	•	•	•
Bit	•	•	•		
Chic		•	•		
Chic Lounge		•	•		
Chic Tables		•	•		
Com	•	•	•	•	
Ellie ^{Pro}		•	•		
Fan		•	•		
Mickey			•		
MyTurn Sofa		•			
Noor	•	•			
Normo		•	•		
Nu		•	•		
October		•			
Revo			•		
Revo Tables		•			
Seven					
SoftBox	•	•			
Sorriso		•	•		
Tables SH/SR/SV/SW		•	•		
Trillo ^{Pro}			•		
Vancouver Lite		•			
Vancouver Oto	•	•			
Wall In	•	•			
Zoo	•	•	•	•	

Details in additional information on specific models.

Consumption of fabric and leather

The quantities below are only estimated. The real quantity of fabric- or leather-consumption may vary in accordance to the quantity of pieces on order. Please notice that before we accept any order in customer's own material we need to make sample trials. Please be aware that not every type of fabric/leather is suitable for upholstery. Volume of customer's own material must be agreed each time with Profim sales organization

Column A - Estimated consumption of fabric (roll width: 1,40 m)

Column B - Estimated consumption of leather (m²)

	A	B		A	B		A	B
Acos^{Pro}			Ellie^{Pro}			Revo		
30H, 30HC, 30V	1,2	1,8	10	2,5	-	P40	1,5	-
			20	2,4	-	P60	2,2	-
Ariz			Fan			SW120	2,4	-
560, 575	0,6	-	10	1,4	1,9	SW180	3,2	-
570	1,6	-	20	2,4	3,3	SW240	3,9	-
Bit			cushion	0,5	0,5	SN150	2,6	-
560, 575	0,6	-	Mickey			SN210	3,3	-
570	1,0	-	seating	0,7	-	B90	1,2	-
580	1,2	-	side of the base	0,25	-	B120	1,5	-
Chic			MyTurn Sofa			B180	2,1	-
10	2,2	3,5	10	3,8	7,4	W90	2,9	-
20	1,2	1,4	20	6,0	10,0	W120	3,8	-
21	1,0	1,1	30	8,7	13,0	W180	5,6	-
Chic Lounge			Normo			SoftBox		
A10	2,2	4,0	500	1,0	-	10, S2	2,2	2,4
A20	2,1	3,3	Nu			1C	2,5	4,0
PV3	1,2	1,6	20	1,6	-	11	3,2	5,5
CU	0,4	0,3	October			20	3,0	4,0
Cushion			10	2,0	2,1	2B	4,4	6,0
CU30	0,4	-	20	3,5	4,0	2R, 2L	4,8	6,5
CU40	0,5	-	11	3,6	5,7	21	4,5	7,2
Com			21	5,5	9,2	3B	6,6	8,7
22	0,5	0,3	31	7,7	12,2	3R, 3L	5,8	8,9
32	1,0	0,7	12	6,5	8,5	31	5,9	9,6
42	1,1	1,1	22	8,0	12,5	1CW*	1,6	-
22CV	0,5	0,3	32	10,5	18,5	11W*	1,8	-
42CV	0,7	0,8				2BW*	1,7	-
						2RW*, 2LW*	2,1	-
						21W*	2,6	-
						3BW*	2,4	-
						3RW*, 3LW*	2,9	-
						31W *	3,3	-

*refers only to screens

Consumption of fabric and leather

	A	B		A	B
Sorriso			Wall In		
10	2,1	2,6	10, 11, 12, 13, B	1,5	2,0
Trillo^{Pro}			20, 21	1,8	2,7
20	0,6	-	22, 23	1,8	2,7
21	1,2	-	30, 31, 32	2,3	3,2
Vancouver Lite			C1, B1	1,6	1,4
1 H/V	2,6	4,1	C2, B2, P1	1,6	1,7
2 H/V	3,6	5,9	P3, P4	1,2	1,7
2,5 H/V	4,0	6,7	W	1,7	-
3 H/V	5,1	8,4	Zoo		
1 HW/VW	1,9	3,2	502	0,7	-
2 HW/VW	2,6	4,8	500	1,1	-
2,5 HV/VW	2,9	5,5			
3 HV/VW	3,5	6,5			
W1	6,7	-			
W2	6,7	-			
W2,5	8,9	-			
W3	8,9	-			
SW	5,5	-			
Vancouver Oto					
R1, R1B	1,2	1,6			
R2, R2B	1,0	1,1			
S1, S1B	1,8	2,6			
S2, S2B	1,1	1,3			

Quilting



Bit / Com

Q1 - quilting on the seat pad
Q2 - quilting on the backrest pad

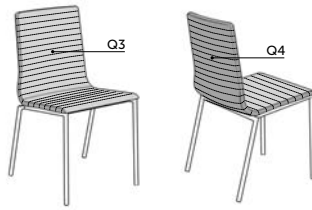

Acos^{Pro} / Com

Q3 - quilting on the whole front part
Q4 - quilting on the whole rear part



Nu / Sorriso

Q5 - quilting on the seat cushion

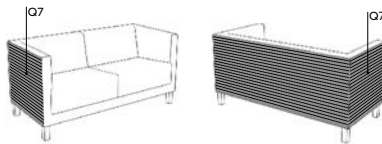

MyTurn Sofa / Vancouver Lite

Q7 - quilting on the outer part of the sides and the back

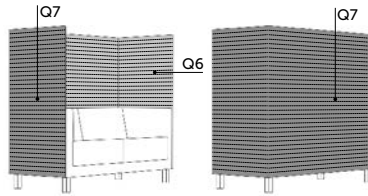

Vancouver Lite

Q6 - quilting on the inner part of the wall
Q7 - quilting on the outer part of the wall

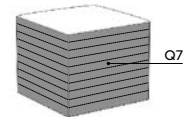

Vancouver Oto

Q7 - quilting on all of the sides

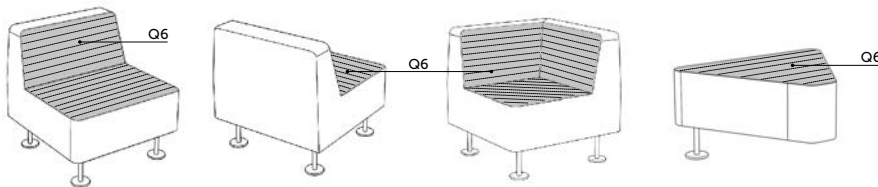

Wall In

Q6 - quilting on the seat and backrest

Measuring methodology

Swivel armchairs and chairs are measured with a mechanism adjusted in such a way that the seat is as much as it is possible positioned levelly, while the backrest vertically. Swivel armchairs and chairs are measured on their castors, whereas visitor and reception chairs on hard glides. The measurements are approximate and can differ depending on the product configuration.

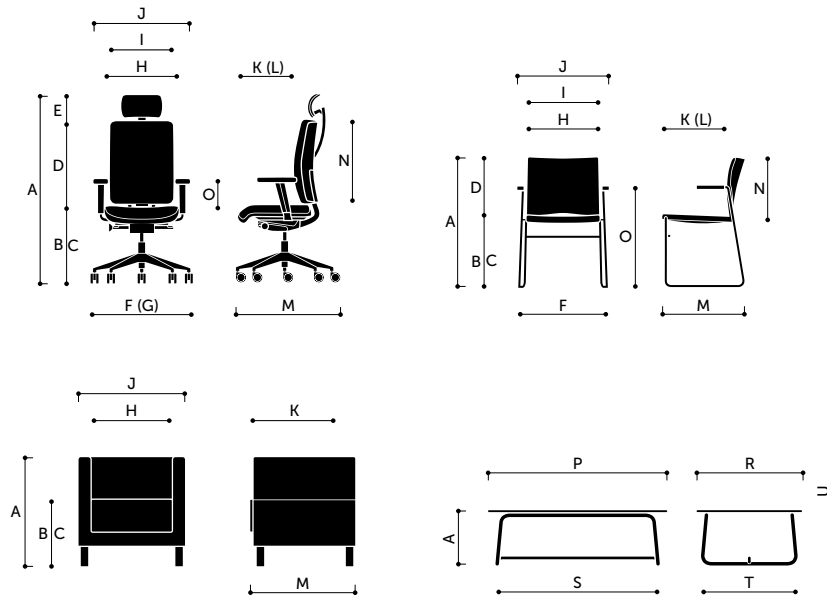

A - Total height

For products fitted with a gas lift - it is measured with gas lift's minimum and maximum extension. For products fitted with an additional backrest and headrest height adjustment - it is measured in both minimum and maximum positions of the backrest, headrest and gas lift.

B - Seat height

Measured at the highest point of the seat. For products fitted with a gas lift - it is measured with absorber's minimum and maximum extension.

C - Seat height with the burden

Seat measured according to EN standards (with seat burden). For products fitted with a gas lift - it is measured with gas lift's minimum and maximum extension.

D - Backrest height

Measured from the seat to the backrest upper edge. For products with adjustable backrest height - it is measured in the minimum and maximum position.

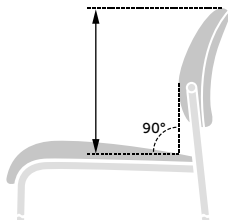

E - Headrest height

Measured from the backrest upper edge to the headrest upper edge. The headrest adjusted in maximum vertical position in relation to the upper and lower edge of the headrest. Measured in the headrest's minimum and maximum position.

F - Base, frame width

Measured at the uttermost points of the base according to the following figures.

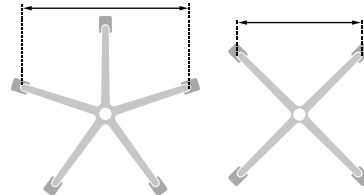

G - Base diameter

Measured according to the figure underneath.

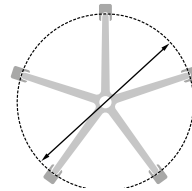

H - Seat width

Measured at the uttermost points of the seat.

I - Backrest width

Measured at the uttermost points of the backrest.

J - Total width

Measured at the uttermost points. For products fitted with adjustable armrests - it is measured with the armrests slid apart to maximum. For products fitted with armrests with adjustable pads - it is measured with the pads slid apart to maximum.

Measuring methodology

K - Seat depth

Measuring the distance between the uttermost point on the seat and the point it touches the backrest (the contact point is determined with a level positioned vertically to the backrest by projecting the S point from the backrest onto the seat) (1). For some shell chairs, where there is no distinct border-line between the seat and the backrest, the depth is measured on the bend halfway between the seat and the backrest (2). For products with additional adjustable seat depth - it is measured with minimum and maximum slide.

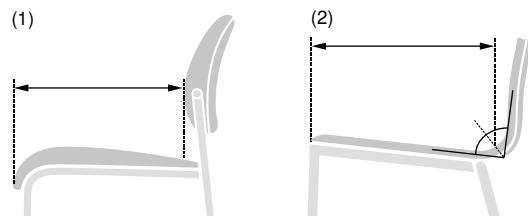

L - Seat (element) length

Measured at the uttermost points of the seat.

M - Total depth

Measured at the uttermost points. Swivel armchairs and chairs are measured according to the drawing underneath. For products with adjustable seat depth - it is measured with minimum and maximum slide.

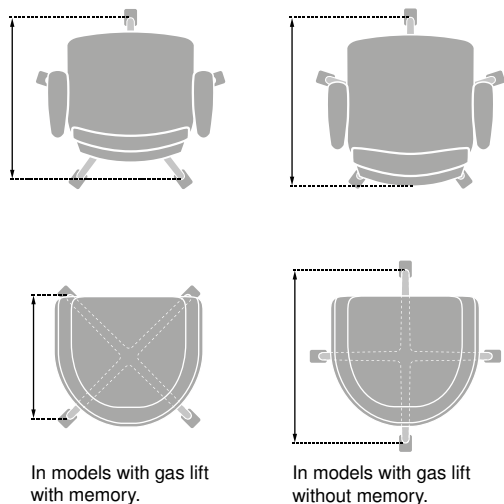

N - Backrest (element) length

Measured at the uttermost points of the backrest.

O - Armrest height

For swivel armchairs and chairs – it is measured from the seat surface to the armrest upper edge. For armrests with adjustable height – it is measured in the minimum and maximum position. For visitor chairs – it is measured from the floor to the armrest upper edge.

P - Table top length

Measured at the uttermost points of the table top.

R - Table top width

Measured at the uttermost points of the table top.

S - Table frame length

Measured at the uttermost points of the table frame.

T - Table frame width

Measured at the uttermost points of the table frame.

U - Table top thickness

Table top (element) thickness is measured.

Terms of guarantee

applies to products manufactured after January 15th, 2019

1. Profim (the Guarantor) guarantees the efficient operation of its products.
2. Claims must be submitted at the purchase location, on a claims form (which can be downloaded from www.profim.eu), together with a purchase document (invoice or guarantee) and the guarantee certificate, if the certificate in question was issued to the Purchaser.
3. Claimed products will be accepted only if cleaned, packaged, and secured against damage in shipping.
4. The claimed product should be delivered, along with the documents listed in point 2, to the purchase location. If the claim is rejected, the product is sent back to the purchase location at the cost of the Purchaser.
5. The Guarantor shall determine whether the claim is justified within 14 days from the claimed products' delivery to manufacturer (together with claim application). A claims department employee will contact the Purchaser by phone or e-mail in order to determine the date and manner of product repair/replacement. Any doubts related to the claims procedure may be clarified with our customer service at +46 380 55 53 80 or info-se@flok.com. Submitting a claim does not entitle the Purchaser to withhold payment for the product.
6. In order to enable the manufacturer to identify the product, the claim notice should include information from the product's LABEL, i.e. the date of manufacture, order number, product number, and configuration. Any tampering with the LABEL will cause the guarantee to become null and void.
7. Guarantee period.
Refers to the products listed in the current price list and on the website www.profim.eu.

Guarantee period	Offer	Operating mode
5 years not longer however than 7 years from production date	Standard Classic - selected products	5 days a week, 8 hours per day (single shift work)
3 years not longer however than 4 years from production date	Classic	5 days a week, 8 hours per day (single shift work)

8. If the product is used for more than 8 hours per day, the guarantee period is reduced to three years.
9. Chair parts (e.g. castors, mechanisms, plastic parts) sold to the Purchaser are covered by a 2 years warranty.
10. If the product is replaced with another product free of defects or repaired by having one of its parts replaced, the course of the guarantee for such product or element is restarted. The guarantee period is extended by the period in which the Purchaser could not make use of the product.
11. If a defect cannot be removed or the removal involves excessive costs, the Guarantor may replace the product with another product free of defects. Any replaced defective products or parts thereof become the property of the Guarantor.
12. In case where an identical product is not available, the Guarantor may replace it with another product free of defects and with identical/similar parameters.

13. Claims concerning mechanical damage (scratches, dents, abrasions, upholstery soiling, missing parts etc.) will be accepted only if submitted within 7 days from the date of handing the product over to the Purchaser. By the above deadline, the Purchaser should unpack the product and remove the wrapping and protective elements in order to rule out mechanical damage. If reservations are made upon delivery with respect to the delivered product, a damage protocol must be drawn up in the presence of the courier or carrier and sent to the Guarantor together with the claims notice.
14. The refusal to hand the product (or any part thereof) over for repair in factory conditions, or preventing repair at the site of the Purchaser, causes the Guarantor to be released from its guarantee obligations and any guarantee claims to be waived.
15. The date of product repair at the site of the Purchaser is scheduled by the Guarantor.
16. Customized products i.e. chairs covered with fabric provided by the Purchaser and manufactured using technology that is not standard for a given product (such as using another base, armrests, covered by a fabric that is not part of standard offer etc.) are covered by one year guarantee.
17. The guarantee covers solely products located on the territory of the Republic of Poland or the country of the Distributor.
18. The Guarantor reserves the right to make innovations in the products that do not alter their durability and usability.
19. Repairs conducted by unauthorized persons or using unauthorized parts will cause the guarantee to become null and void.
20. The Purchaser's rights hereunder do not include the right to pursue lost profits and be indemnified for any potential damage caused by product failure.
21. The Guarantor's liability covers solely defects inherent in the product sold.
22. If the product is damaged after the expiry of the guarantee, the Guarantor may send, if possible, the Purchaser the required element or cure the defect using its factory service. In both cases the Purchaser will be charged accordingly.

Terms of guarantee

applies to products manufactured after January 15th, 2019

THE GUARANTEE DOES NOT COVER:

- a) defects caused by assembling the product in a manner not compliant with the manual and using it in a manner not compliant with its purpose,
- b) damage caused during transport and transloading (does not apply to transport provided by the Guarantor),
- c) failure to observe the recommendations contained in the user's manual, damage to castors, glides or floor caused by the inappropriate choice of available options (e.g. using hard castors on hard surfaces); the proper choice of options does not rule out damages that may be caused by using the chairs on carpets, panels, parquet floors etc. of inappropriate quality or on soiled surfaces (e.g. by sand),
- d) damage resulting from extreme climate conditions or environmental factors (e.g. acids, humidity etc.),
- e) damage caused by departing from standard specifications at the customer's request,
- f) operational wear and tear of wheels or upholstery materials,
- g) wear and tear of felt glides, which can be replaced under warranty, only in case the felt come away,
- h) differences in the fabrics shade, if the products come from different manufacturing series of the fabric manufacturer, and differences in individual products purchased by the Purchaser successively are claimed,
- i) discoloration of upholstery caused by some of the clothing colourants and additional colourants (such as those used in denim) which may transfer onto lighter upholstery (the effect can be intensified due to humidity and temperature and is irreversible),
- j) soiling and permanent discolouring of upholstery caused by external factors,
- k) leather upholstery products, where the natural features of the material, such as smell, difference in the structure, texture and shade differences, scars and insects pricks are claimed; during use (e.g. on the seat) the leather takes on shine and becomes looser; the Guarantor does not accept claims motivated by the above features,
- l) foam deformations,
- m) differences in the hardness of polyurethane cold-moulded foam resulting from parameter variations, which according to the DIN 53576/ISO 2439 norm are acceptable if within the range of +/- 10%,
- n) damaging the surface of wooden elements as a result of contact with the edges of desks or other office furniture; mechanical damage of wooden surfaces is not considered to be a product defect,
- o) wooden components used in products, if the slight differences occurring in individual elements are claimed; the character of the raw material makes it impossible to precisely determine the final aesthetic effects, defined by the wood colour, shade, and figure,
- p) differences in geometry of plywood shells, which, because of their natural properties, may differ in tolerance of +/- 1.5 degrees,
- r) small variations in HPL colours, in accordance with PN-EN 438 norm.
- s) differences in colour, gloss, tone or pattern in ceramic table tops. It is natural material and above features are characteristic of this type of surface.

GENERAL REMARKS CONCERNING PRODUCT USE:

23. The products should be protected against the direct influence of sunrays.
24. Leather products should not be placed next to a heater or another heat source. Please observe a minimum distance of 30 cm from the heat source.
25. Leather should be maintained using special care products that create a protective layer resistant to water and oil substances.
26. Products should be protected against becoming wet.
27. The upholstery fabric should be protected against soiling by grease, sweat, lubricants etc. In case of soiling, apply appropriate cleaning agents.
28. Avoid exposing upholstery to extensive, focused tension (for example standing on a chair) that can result in splitting or a rip of stitching as well as mechanical damage to upholstery.
29. Upholstered furniture is supposed to be used to sit evenly on the seat surface to avoid natural tendency of fabrics and leather to creasing and wrinkling due to ongoing pressure, temperature and the moist of the body (wrinkling and creasing is not a product fault but a natural effect; the bigger the upholstered surface the higher tendency for this effect to occur).
30. Products should be dusted at least once a week.
31. Hard castors are used with soft carpeting and carpets.
32. Soft castors are used with hard floors (e.g. PVC, parquet floors, floor panels).
33. Remarks concerning the use of products containing plywood elements:
 - temperature range from +15°C to +30°C,
 - humidity range from 40% to 65%.
34. Ceramic tops meet the frost resistance requirements per EN 10545-12.
35. Table Chic RH and RR with metal and ceramic table top (apply only when frame/column is made of EPO1, EPO2, EPO3, with hard or teflon glides) can be for outdoor use according to EN 12944-2 cat. C3.
36. Plastic elements of the products like bases, armrests cover (especially light grey colours) require regular cleaning adequate to density of usage.

Fabrics and finishings

Profim Standard fabrics

EVO - PRICE GROUP 0

Evo is a uni-coloured polyester crepe fabric. The irregular weave structure add shine and good stretch.

Composition: 100% polyester

Weight: 320 g/m²

Abrasion resistance: 180 000 Martindale (EN ISO 12947-2)

Flammability: BS EN 1021: 1-2 (Cigarette & match)

Light fastness: 4-5 (EN ISO 105-B02)

Rubbing fastness: 4-5 (Wet/Dry) (EN ISO 105-X12)

Pilling resistance: 5 (EN ISO 12945-2)

Environmental facts: EU Ecolabel, Oeko-Tex® Standard 100, ISO 14001 certified company

Design: Miranda Design Team

Produced in: Poland

Cleaning & disinfection: Dry cleaning with tetrachloroethylene and water solution of carbonate fluoride

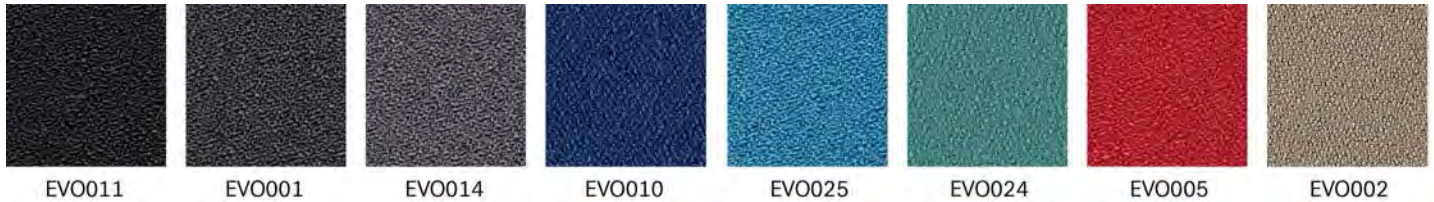

CURA (GABRIEL) - PRICE GROUP 1

Cura is a two-coloured fabric made from 98% post-consumer recycled polyester. It has a matt, slightly irregular and natural-looking texture where the dark, underlying grey fibers create a discreet yet vibrant melange effect. High durability and stretchability and its soft, voluminous touch make Cura suitable for both office and lounge furniture.

Composition: 98% post-consumer recycled polyester, 2% polyester

Weight: 420 g/m²

Abrasion resistance: 100 000 Martindale (EN ISO 12947-2)

Flammability: BS EN 1021: 1-2, BS 5852 0&1, CA TB 117-2013, ASTM E 84 Class I

Light fastness: 5-8 (EN ISO 105 - B02)

Rubbing fastness: 4-5/4-5 (Wet/Dry) (EN ISO 105X12)

Pilling: 4-5 (EN ISO 12945-2)

Environmental facts: EU Ecolabel, Oeko-Tex® Standard 100, Contains no Flame Retardant chemicals, ISO 14001 certified company

Design: Cenk Kivrikoglu

Produced in: Lithuania

Cleaning: Wash or dry cleaning, Can be disinfected with ethanol and is bleach-cleanable (For further info follow Gabriel´s cleaning guidelines – www.gabriel.dk)

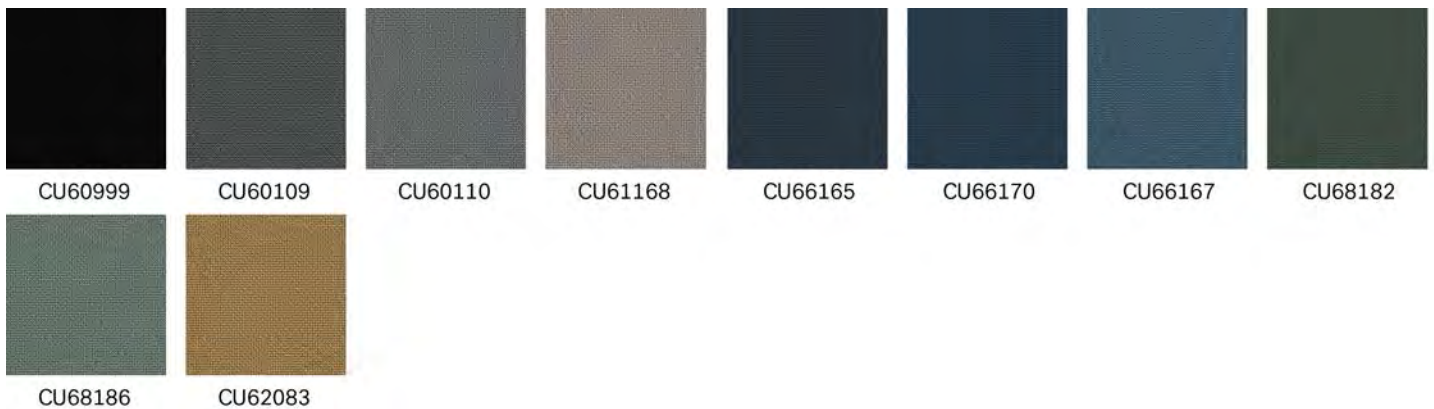

TONAL (GABRIEL) - PRICE GROUP 1

Tonal is a post-consumer recycled polyester fabric in a two-coloured melange. It has a discreet textured look with a fusion of light and dark tones adding depth to the colours.

Composition: 99% post-consumer recycled polyester, 1% polyester

Weight: 315 g/lm

Abrasion resistance: 100 000 Martindale (EN ISO 12947-2)

Flammability: BS EN 1021: 1-2, BS 476 Part 7 class 1, CA TB 117-2013, ASTM E 84 Class I

Light fastness: 6-8 (EN ISO 105 - B02)

Rubbing fastness: 4-5/4-5 (Wet/Dry) (EN ISO 105X12)

Pilling: 4-5 (EN ISO 12945-2)

Environmental facts: EU Ecolabel, Oeko-Tex® Standard 100, Contains no Flame Retardant chemicals, ISO 14001 certified company

Design: Cenk Kivrikoglu

Produced in: Lithuania

Cleaning: Wash or dry cleaning. Can be disinfected with ethanol and is bleach-cleanable (For further info follow Gabriel's cleaning guidelines - www.gabriel.dk)

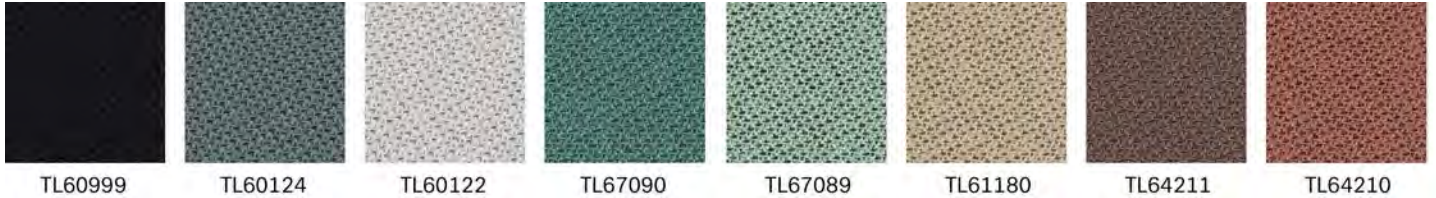

XTREME (CAMIRA) - PRICE GROUP 1

Xtreme is a crepe fabric made from 100% post-consumer recycled polyester that features exceptional Euro flammability performance. Extra stretch and structure gives an irregular, shiny finish.

Composition: 100% post-consumer recycled polyester

Weight: 310 g/m²

Abrasion resistance: >100 000 Martindale (EN ISO 12947-2)

Flammability: BS EN 1021: 1-2 (Cigarette & match), BS 7176 Low & Medium Hazard, BS 5852 Section 4 Crib 5, DIN 4102 B1, UNI 9175 Class 1 IM, NF D 60-013

Light fastness: 6 (EN ISO 105 - B02: 2013)

Rubbing fastness: 4/4 (Wet/Dry) (EN ISO 105X12)

Pilling: 5 (EN ISO 12945-2)

Environmental facts: EU Ecolabel, Oeko-Tex® Standard 100, Indoor Advantage™ "Gold", non metallic dyestuffs, ISO 14001 certified company.

Design: Camira Design Studio

Produced in: United Kingdom

Cleaning & disinfection: Washable to 60 °C and bleach cleanable (For further info follow Camira's cleaning guidelines - www.camirafabrics.com)

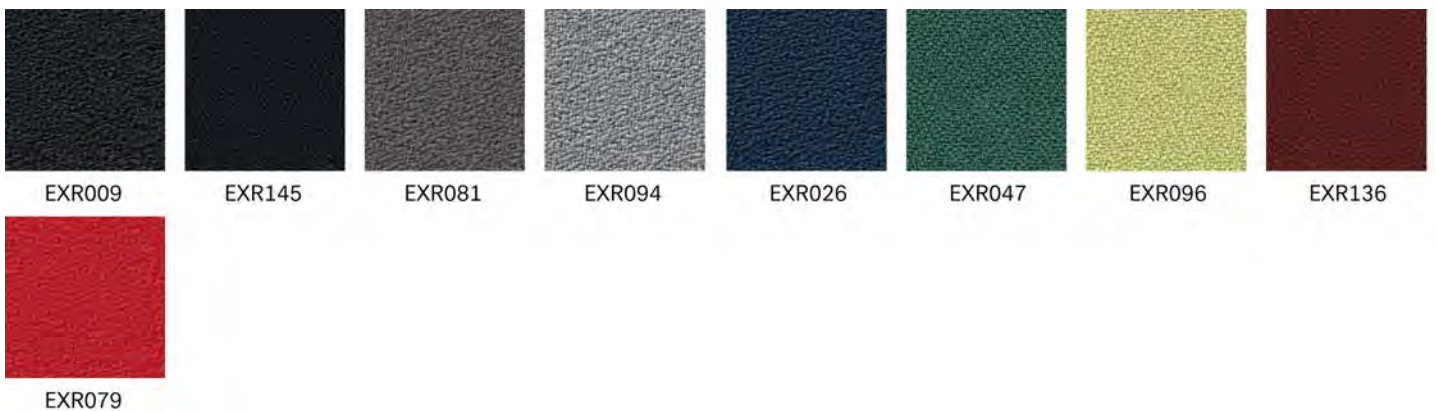

SELECT (GABRIEL) - PRICE GROUP 2

Select is a classic woolen fabric with a tightly woven relief structure, combining excellent softness, stretch and durability. Its rich texture with the interplay of light and shadow add depth in all the colours in the palette.

Composition: 85% New Zealand wool, 15% polyamide

Abrasion resistance: 200 000 Martindale (EN ISO 12947-2)

Flammability: BS EN 1021: 1-2, BS 5852 0&1, BS5852 Crib 5, CA TB 117-2013, IMO MSC 307(88) Annex 1 part 8/MED registration IMO

Light fastness: 5-8 (EN ISO 105 - B02)

Rubbing fastness: 4-5/4-5 (Wet/Dry) (EN ISO 105X12)

Pilling: 4 (EN ISO 12945-2)

Environmental facts: EU Ecolabel, Oeko-Tex® Standard 100, 100% free of heavy metals, ISO 14001 certified company

Design: Cenk Kivrikoglu

Produced in: Lithuania

Cleaning: Professional dry cleaning (For further info follow Gabriel's cleaning guidelines - www.gabriel.dk)



CAPTURE (GABRIEL) - PRICE GROUP 3

Capture is a lightly felted and multi-coloured wool fabric combining softness, stretch and strenght. It fuses light and dark colours to a refined melange pattern in subtle nuances, which add richness and depth to the design.

Composition: 85% New Zealand wool, 15% polyamide

Abrasion resistance: 200.000 Martindale (EN ISO 12947-2)

Flammability: BS EN 1021: 1-2 (Cigarette & match), BS 5852 Part 1 0,1 (Cigarette & match), CA TB 117-2013, Class Uno UNI 9175 Class 1 IM

Light fastness: 5-7 (EN ISO 105-B02)

Rubbing fastness: 4-5/4-5 (Wet/Dry) (EN ISO 105X12)

Pilling: 4-5 (EN-ISO 12945-2)

Environmental facts: EU Ecolabel, Oeko-Tex® Standard 100, 100% free of heavy metals, ISO 14001 certified company

Design: Cenk Kivrikoglu

Produced in: Lithuania

Cleaning: Professional dry cleaning (For further info follow Gabriel's cleaning guidelines - www.gabriel.dk)



OCEANIC (CAMIRA) - PRICE GROUP 3

Oceanic is made from 100 % post-consumer recycled polyester yarn where 90% are created from post-consumer plastic bottles diverted from landfill and 10% is upcycled marine plastic(from marine litter). It is a fabric born out of the SEAQUAL Initiative designed to combat marine plastic pollution and achieve a waste free environment. Oceanic has a two coloured diagonal structure with a matte surface and soft touch.

Composition: 100 % post-consumer recycled polyester, including 50% SEAQUAL yarn

Weight: 497 g/m² ±5%

Abrasion resistance: >100 000 Martindale (EN ISO 12947-2)

Flammability: BS EN 1021: 1-2 (Cigarette & match), BS 7176 Low, BS 7176 Medium Hazard with EnviroFlam5, CA TB 117-2013

Light fastness: 5 (EN ISO 105 - B02: 2013)

Rubbing fastness: 4/4 (Wet/Dry) (EN ISO 105X12)

Pilling: 4 (EN ISO 12945-2)

Environmental facts: EU Ecolabel, Oeko-Tex® Standard 100, Indoor Advantage™ "Gold", non metallic dyestuffs, ISO 14001 certified company.

Design: Camira Design Studio

Produced in: United Kingdom

Cleaning & disinfection: Washable at 60 °C and bleach cleanable (For further info follow Camira´s cleaning guidelines – www.camirafabrics.com)

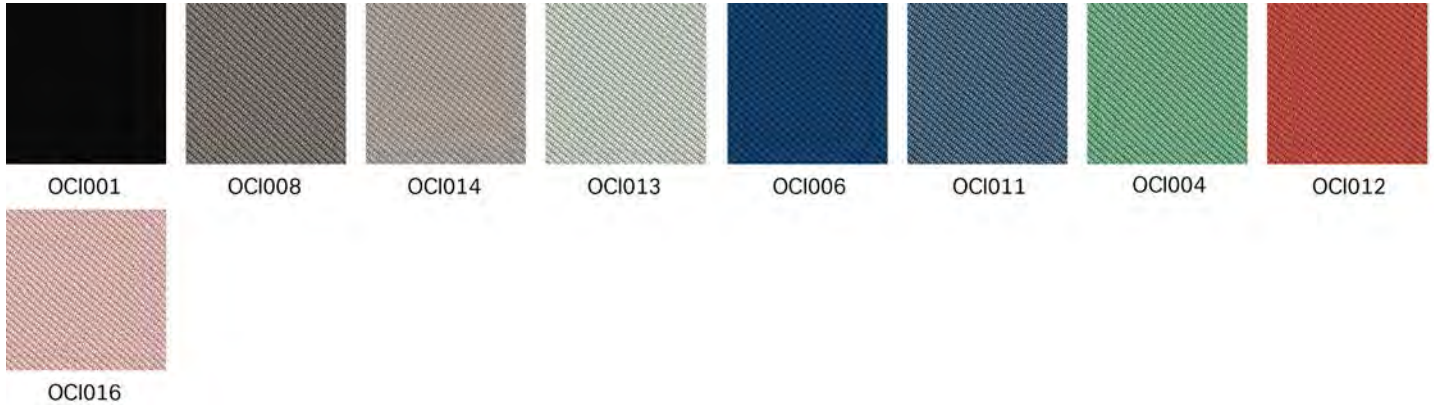

STEP (GABRIEL) - PRICE GROUP 3

Step is unique in both texture and performance. With its delicate surface, Step is perceived as vivid and interesting. The texture with the fire-resistant Trevira CS yarn ensures that the fabric is suited for use in environments with high fire safety and durability requirements.

Composition: 100% Trevira CS

Weight: 336 g/m²

Composition: 100% Trevira cs

Abrasion resistance: 100 000 Martindale (EN ISO 12947-2)

Flammability: BS EN 1021: 1&2 (Cigarette & match), BS 5852 0&1 (Cigarette & match), BS 5852 Crib 5, CA TB 117-2013, MED Certificate IMO, Class Uno UNI 9175 Class 1 EMME, ÖNORM

Light fastness: 5-7 (EN ISO 105 - B02)

Rubbing fastness: 4-5/4-5 (Wet/Dry) (EN ISO 105X12)

Pilling: 4-5 (EN ISO 12945-2)

Environmental facts: EU Ecolabel, Oeko-Tex® Standard 100, 100% free of heavy metals, ISO 14001 certified company

Design: Inger Mosholt Nielsen

Produced in: Lithuania

Cleaning: Professional dry cleaning (For further info follow Gabriel's cleaning guidelines www.gabriel.dk)

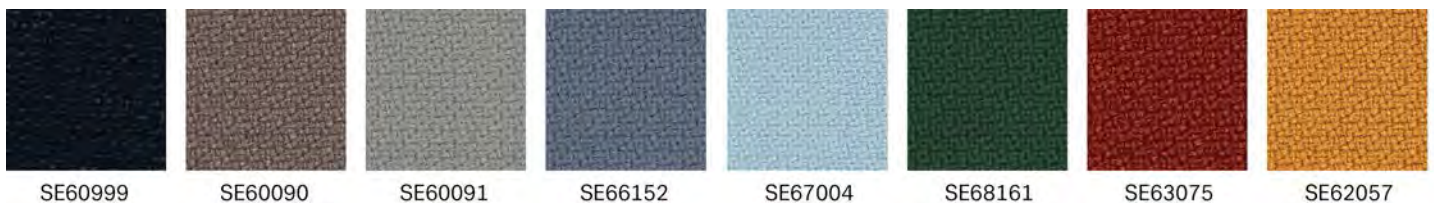

SYNERGY (CAMIRA) - PRICE GROUP 3

Epitomising natural simplicity, Synergy is a wool rich fabric which is at once both irresistibly soft and ultra-high performing. Delicately felted, with a beautifully relaxed drape, the understated aesthetics showcase the intriguing coloration of this considered textile.

Composition:

- 95% wool
- 5% polyamide
- **Weight:** 400 g/m²

Certificates:

- **Abrasion resistance:** 100000 Martindale cycles (BS-EN ISO 12947-2)
- **Pilling resistance:** 4 (BS-EN ISO 12945-2)
- **Flammability:** cigarette (BS-EN 1021-1)
- **Flammability:** match (BS-EN 1021-2)
- **Flammability:** (UNI 9175 Class 1IM)
- **Light fastness:** 5 (ISO 105-B02)
- **Maintenance:**
 - -vacuum regularly
 - -use dry-clean preparations
 - -do not bleach

Because of the fact that the fabric Synergy is composed of 95% natural fiber, each of the batches shows variations in shade, which may be visible in products of follow-up orders. Additionally, an inherent feature of all natural fibers is the tendency to delicate fabric pilling.

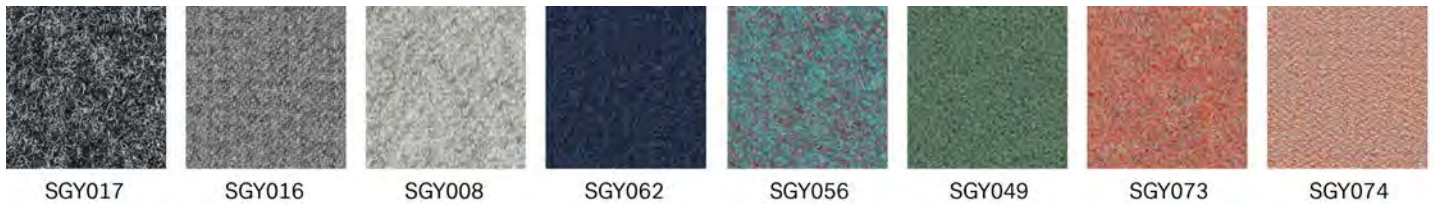

STEELCUT 3 (KVADRAT) - PRICE GROUP 4

Steelcut 3 is a unicoloured strong worsted wool and polyamide woven fabric, combining durability, soft touch and colour depth. The construction create a three-dimensional surface resembling small pyramids or steel points. Despite its complex weaving technique, it has a simple and precise expression.

Composition: 90% worsted new wool, 10% polyamide

Weight: 825 g/lm

Abrasion resistance: 100 000 Martindale (EN ISO 12947-2)

Flammability: BS EN 1021: 1-2 (Cigarette & match, CA TB 117-2013, BS 5852 Crib 5 (with treatment), BS 5852 part 1, IMO FTP Code 2010 Part 8, NF D 60 013, NFPA 260, UNI 9175 1IM, ÖNORM B1/Q1, AS/NZS 3837 Class 2, ASTM E84 Class A Unadhered, ASTM 84 Class B Adhered

Light fastness: 5 6 (EN ISO 105-B02)

Rubbing fastness: 3-5/4-5 (Wet/Dry) (EN ISO 105X12)

Pilling: 3-4 (EN ISO 12945-2)

Environmental facts: EU Ecolabel, 100% free of heavy metals, ISO 14001 certified company, GREENGUARD Gold

Design: Frans Dijkmeijer, Giulio Ridolfo (updated colourways)

Produced in: United Kingdom

Cleaning: Professional dry cleaning with tetrachloroethylene, normal process (For further info follow Kvadrat´s cleaning guidelines – www.kvadrat.dk)

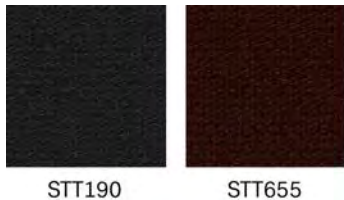

STEELCUT TRIO 3 (KVADRAT) - PRICE GROUP 4

Steelcut Trio 3 is a strong worsted wool and polyamide woven fabric, made with three different coloured yarns. The colours and the special weave create a three-dimensional surface where the colours seem to change depending on the angle of perspective. Like Steelcut 3, despite the complexity of the textile's innovative weave, it has a simple, precise expression.

Composition: 90% worsted new wool, 10% polyamide

Weight: 770 g/lm

Abrasion resistance: 100 000 Martindale (EN ISO 12947-2)

Flammability: BS EN 1021: 1-2 (Cigarette & match, CA TB 117-2013, . BS 5852 Crib 5 (with treatment), BS 5852 part 1, BS 5852 ignition source 3, IMO FTP Code 2010 Part 8, NF D 60 013, NFPA 260, UNI 9175 1IM, ÖNORM B1/Q1, AS/NZS 3837 Class 2, GB 50222 B1 with treatment (Chinese)

Light fastness: 6-7 (EN ISO 105-B02)

Rubbing fastness: 3-5/4-5 (Wet/Dry) (EN ISO 105X12)

Pilling: 4 (EN ISO 12945-2)

Environmental facts: EU Ecolabel, 100% free of heavy metals, ISO 14001 certified company, GREENGUARD Gold

Design: Frans Dijkmeijer, Giulio Ridolfo (updated colourways)

Produced in: United Kingdom

Cleaning: Professional dry cleaning with tetrachloroethylene, normal process (For further info follow Kvadrat's cleaning guidelines – www.kvadrat.dk)



PALOMA SOFT (WOLLSDORF) - PRICE GROUP 6

High quality semi-aniline leather. All our standard colours from Paloma have a special finish adding a particular softness to the leather. Excellent friction and breathing properties. The surface may feature small scars and marks resulting from insect bites etc. These are proof of the natural origin of the product and are part of its character.

Flammability: BS EN 1021: 1-2 (Cigarette & match), BS 5852 Crib 5, IMO A.652 (16)

Light fastness: 6 (EN ISO 105-B02)

Rubbing: Wet 80/4 -Dry 2000/4 - Sweat 50/4 - ISO 11640

Finish-adhesion: 2.0 N/cm ISO 11644

Tear-strength: 20 N/mm DIN 53329- A

Environmental facts: Tanned without using chromium salts, BlueAngel, ECO2L-certificate, ISO 14001 certified company

Produced in: Austria

Animal Welfare: All hides are by-products from the meat and dairy industries, only use hides from healthy and uninjured animal. Following European standards as a minimum and the "Five Freedoms" of livestock as defined by FAWC (Farm Animal Welfare Council)

Cleaning: Follow the leather care guide from our supplier – www.wollsdorf.com



Fabrics and finishings

Mesh

Ariz

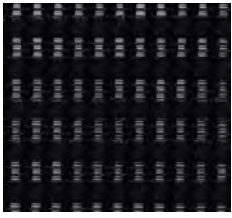

GZ-21

Mesh

Bit



Runner 60061

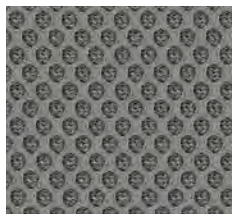

Runner 60011



Runner 60999

Mesh

Zoo



Runner 60061

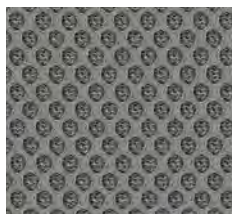

Runner 60011



Runner 60999

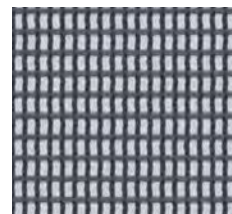

String 60118

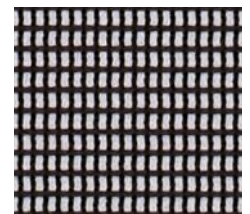

String 60999

Fabrics and finishings

Plastics

Ariz



CODE 20



CODE 517



CODE 01



CODE 516



CODE 503



CODE 513



CODE 3020

Plastics

Ellie^{Pro}/ Trillo^{Pro}

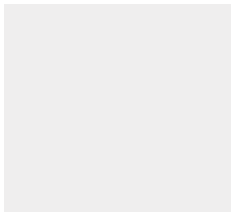

Light grey (RAL 7047)

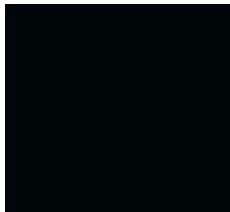

Black

Plastics

Mickey

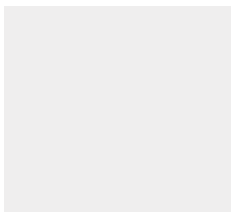

Light grey (RAL 7047)



Grey (RAL 7043)

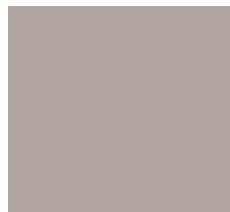

Beige (RAL 7036)

Fabrics and finishings

Plastics / frames

Zoo

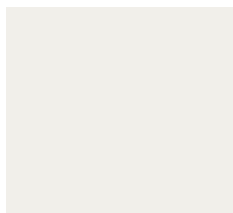

Light grey (NCS S 2500-N)



Grey (NCS S 6500-N)

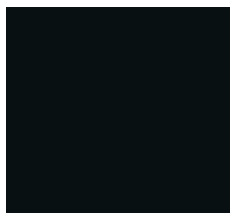

Black (RAL 9005)

Tempered glass

Chic Tables

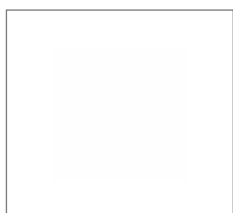

G1 (Milky)

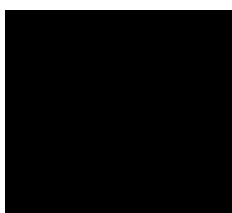

G2 (Black)



G3 (RAL 7044)



G4 (RAL 7042)

Kolor stelaży / Frame colours / Gestellfarben

Legenda / Legend / Legende:

- Nowość / New colour / Neue Farbe
- Bez zmian / No changes / Keine Änderungen



		MetallicPro	Chrome	Black / RAL 9005	White / RAL 9016	Light Grey / NCS S 2500 N	Grey / NCS S 6500 N	Deep Green / RAL 6004	Navy Blue / RAL 5003	Burgundy / RAL 3005	Salvia/Green / RAL 6021	Blue / RAL 5014	Terracota / RAL 3012	Gold	Metalsilver	Graphite
Acos ^{Pro}	V, H, HC	●	○	○	●	●	●	●	●	●	●	●	●			
Arca	V, V PP	●	○	○	●											
Ariz	V, V 2P, CV	●	○	○	●	●	●	●	●	●	●	●	●			
Bit	H, V	●	○	○	●											
Chic	H	●	○	○	○	●	●	●	●	●	●	●	●	●		
Chic	CH	●	○	●	●	●	●	●	●	●	●	●	●			
Chic Lounge	V3, PV3, F	●	○	○	●	●	●	●	●	●	●	●	●	●		
Chic Tables	RR	●	○	○	●	●	●	●	●	●	●	●	●			
Chic Tables	RH, CS, CR	●	○	○	●	●	●	●	●	●	●	●	●	●		
Com	HC, HF, HS	●	○	○	●	●	●	●	●	●	●	●	●	●		
Com	H, H 2P, V, CV, V1, V1 2P, V2	●	○	○	●	●	●	●	●	●	●	●	●			
Ellie ^{Pro} (polished alu)	HST	●	○	○	○											○
Ellie ^{Pro}	V3	●		○	●	●	●							●	○	
Fan	H, HC, HS, V	●	○	○	●	●	●	●	●	●	●	●	●	●		
Fan	R	●	○	●	●	●	●	●	●	●	●	●	●			
MyTurn Sofa	H, V	●	○	○												
MyTurn Sofa Tables	H, V	●	○	○												
MyTurn	VN		○													
Normo	H, V, HS, HC	○		○	○	○	○	○	○	○	○	○	○			
Nu	H, V3	●	○	○	●	●	●	●	●	●	●	●	●	●		
Nu (polished alu)	HC	●	○	○	○											○
Nu	R	●	○	●	●	●	●	●	●	●	●	●	●			
October	-	●	○	○												
October Tables	-	●	○	○												
Revo Tables	-	○		○	○	●	●	○	○	○	○	○	○			
Seven	-	●		○	○	●	●	●	●	●	●	●	●			
SoftBox (polished alu)	-		○	○												
SoftBox Tables	-		○	○												
Sorriso	V	●	○	○												
Sun	H, V, H 2P, H 2PB	●	○	○												
Tables	SV, SH, SR	●	○	○	●	●	●	●	●	●	●	●	●			
Trillo ^{Pro} (polished alu)	HST	●	○	○	○											○
Vancouver Lite	H, V	●	○	○												
Wall In	-	●	○	○												
Xenon	H, V, H 2P, V 2P	●	○	○												
Xenon Net	H, V, H 2P, V 2P	●	○	○												
Zoo	H, H 2P, HC, HC 2P	●	○	○	●	○	○									

Kolory drewna i sklejkki / Wood colours / Holzfarben

Legenda / Legend / Legende:

- Nowość / New colour / Neue Farbe
- Bez zmian / No changes / Keine Änderungen

	Sklejka bukowa / Stained beech / Holz (Schichtholz Buche)			Okleiny naturalne / Natural veneers / Beiztöne Holz				Okleiny naturalne barwione / Coloured natural veneers / Farben von Edelurnier				
	H6	H12	H5	Ash (NA)	Beech (NB)	Oak (NO)	Walnut (NW)	White Ash CNA01	Black Ash CNA02	Deep Green Ash CNA05 (RAL 6004)	Navy Blue Ash CNA06 (RAL 5003)	Burgundy Ash CNA07 (RAL 3005)
Chic	○	○	○									
Chic Tables				●	●	●	●	●	●	●	●	●
Com	○	○	○	●		●	●	●	●	●	●	●
Ellie ^{Pro}	○	○	○									
Fan	○	○	○									
MyTurn Sofa Tables												
Nu	○	○	○									
October	○	○	○									
October Tables	○	○	○									
Revo Tables				○	○	○	○	○	○	○	○	○
SoftBox Tables												
Tables SH/SR												
Tables SW	○	○	○									
Wall In												

Kolory drewna i sklejkki / Wood colours / Holzfarben

Legenda / Legend / Legende:

- Nowość / New colour / Neue Farbe
- Bez zmian / No changes / Keine Änderungen

	Okleiny naturalne modyfikowane / Natural modified veneers / Beiztöne Holz							Drewno (dąb) / Wood (Oak) / Holz (Buche)						
	HM10	HM11	HM12	HM20	HPL	White LW01 (RAL 9016)	Light Grey LW03 (NCS S 2500-N)	Grey LW04 (RAL 7037)	Black LW02 (RAL 9011)	Navy Blue LW06 (RAL 5003)	Light Burgundy LW07 (RAL 3004)	HO6	HO12	HO11
Chic														
Chic Tables														
Com						○	●	○	○	●	●			
Ellie ^{Pro}														
Fan												○	○	○
MyTurn Sofa Tables	○	○	○	○		●		●	●					
Nu														
October														
October Tables														
Revo Tables						○	●	●	○	○	○			
SoftBox Tables	○	○	○	○		○		○	○					
Tables SH/SR						○	●	○	○	●	●			
Tables SW												○	○	○
Wall In						○	●	○	○	●	●			

Kolory kubeków / Shell colours / Schalenfarbe

Legenda / Legend / Legende:

- Standardowy czas realizacji / Standard delivery time / Standardlieferzeit
- Wydłużony czas realizacji / Extended delivery time / Verlängerte Lieferzeit

	Plastics														Veneer shell		
	Poppy	Vanilla	Straw	Rose	Coral	Sky	Sea Green	Teal Blue	Forest	Misty Grey	Clay	Graphite	Graphite – recycled PP	Charcoal	Oak	Dark stained Oak	
Ana	●	●					○	●		●		●	●				
Noor 6050/6055	○	●	○	○	○	○	●	●	○	●	●	●			●	○	
Noor 6060/6065	○	●	○	○	○	○	●	●	○	●	●	●			●	○	
Noor 6070/6075	○	●	○	○	○	○	●	●	○	●	●	●			●	○	
Noor 6080/6085	○	●	○	○	○	○	●	●	○	●	●	●			●	○	
Noor Up 6090/6095	○	●	○	○	○	○	●	●	○	●	●	●			●	○	

Kolory stelaży / Frame colours / Gestellfarbe

Legenda / Legend / Legende:

- Standardowy czas realizacji / Standard delivery time / Standardlieferzeit
- Wydłużony czas realizacji / Extended delivery time / Verlängerte Lieferzeit

	Frames											Aluminium elements			Wood (Ash)			Aluminium elements for base 6080/6085	
	Lingon RAL 3000	Snow (White) RAL 9016	Canola	Rose	Aqua	Sea Green	Teal Blue	Forest	Misty Grey	Black RAL 9005	Metalsilver	Steelgrey	Polished Alu	White stained Ash	Stained Ash	Dark stained Ash	Black painted Aluminium frame	Polished Aluminium frame	
Ana	○	●				○	●		●	●	●						●		
Noor 6050/6055	○	○		○		●	●	○	○	●	●								
Noor 6060/6065	○	●	○	○	○	●	●	○	○	●	●								
Noor 6070/6075		○							●			○							
Noor 6080/6085													○	●	○		●	○	
Noor Up 6090/6095	○	●	○	○	○	●	●	○	○	●	●								

Kolory blatów / Table tops colours / Plattefarbe

Legenda / Legend / Legende:

- Standardowy czas realizacji / Standard delivery time / Standardlieferzeit
- Wydłużony czas realizacji / Extended delivery time / Verlängerte Lieferzeit

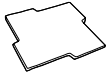

	HPL													Linoleum					Melamine	
	Polar White Mat Formica F2255	Folkstone Formica F7927	Sarum Grey Formica F2770	Diamond Black Formica F2253	Oak natural Formica F1079	Birch Formica F7921	Pale Ash Nat Formica F1004	Elegant Oak Nat Formica F5374	Refined Walnut Nat Formica F5872	Dark Ash Nat Formica F8575	Kashmir Mat Formica F0187	Oyster Grey Mat Formica F7929	Pumice Mat Formica F7858	Olive Forbo Desktop 4184	Smokey Blue Forbo Desktop 4179	Burgundy Forbo Desktop 4154	Iron Forbo Desktop 4178	Beech M3227		
Allround	●	●	○	○	○	○	○	○	○	○	○	○	○	○	○	○	○	●		
u-Connect	●	●	○	○	○	○	○	○	○	○	○	○	○	○	○	○	○	●		
Eminent	●	●	○	○	○	○	○	○	○	○	○	○	○	○	○	○	○	●		
Standard Folding table	●	●	○	○	○	○	○	○	○	○	○	○					●			

Kolory stelaży / Frame colours / Gestellfarbe

Legenda / Legend / Legende:

- Standardowy czas realizacji / Standard delivery time / Standardlieferzeit
- Wydłużony czas realizacji / Extended delivery time / Verlängerte Lieferzeit



	Snow RAL 9016	Misty Grey	Metalsilver	Steelgrey	Black RAL 9005/RAL9011	Polished aluminium
Allround	●		●	●	●	
u-Connect	●	●		●	●	○
Eminent	●		●	●	●	
Standard Folding table		●	●	●		

Rozmiary blatów / Table top sizes / Plattenmaßen

Legenda / Legend / Legende:

- Standardowy czas realizacji / Standard delivery time / Standardlieferzeit
- Wydłużony czas realizacji / Extended delivery time / Verlängerte Lieferzeit
- Standard / Extended

cm	ø60	ø70	ø80	ø100	ø120	ø160	1/2 circle ø160	Ellipse 180 x 100	Trapezium 140x70x70x70, depth 60	80 x 80	90 x 60	120 x 45	120 x 60	120 x 70	120 x 80	120 x 90	140 x 60	140 x 70	140 x 80	160 x 70	160 x 80	180 x 70	180 x 80	180 x 90	
Allround	○	●	○	○	○			○		○				●	●			●	●			○	○	●	○
u-Connect													●	●	●			●	●	●	●	●	●	●	●
Eminent					○	○			○	○			●		●			○	●	●		●		●	
Standard Folding table							○				●	●	●	●	●	●	●	●	●	●	●	●	○	●	○

Fabrics - Extended

Lead time 30-40 working days

- Legend: ● Possibility of making the product in the given upholstery
 ○ Possibility of making only the seat in the given upholstery
 □ No possibility of making the walls in the given upholstery
 ◇ Handle always in fabric Next
 - Impossibility of making a product in a given upholstery

	Camira											Gabriel										
	Blazer (PG 3)	Craggan Flax (PG 4)	Era (PG 3)	Gravity (PG 3)	Main Line Flax (PG 3)	Rivet (PG 3)	Nexus (PG 3)	Rivet (PG 3)	Urban (PG 3)	X2 (PG 3)	Breeze Fusion (PG 4)	Chilli (PG 3)	Comfort+ (PG 5)	Crisp (PG 3)	Cyber (PG 3)	Fame (PG 2)	Focus (PG 3)	Focus Melange (PG 3)	Go_Check (PG 3)	Focus Royal (PG 3)	Gaja Classic (PG 3)	
Ana	●	●	●	●	●	●	●	●	●	●	●	●	●	●	-	●	●	●	●	●	●	●
Ariz	●	●	●	●	●	●	●	-	●	●	●	●	●	-	●	●	●	●	●	-	●	●
Bit	●	-	●	-	●	●	-	-	●	●	-	●	●	-	●	●	●	●	●	-	●	●
Chic	●	-	●	-	●	●	●	-	●	●	●	●	●	-	●	●	●	●	●	-	●	●
Chic Lounge	●	-	●	-	●	●	-	-	●	●	●	●	●	-	●	●	●	●	●	-	●	●
Com	●	-	●	-	●	●	●	-	●	●	●	●	●	-	●	●	●	●	●	-	●	●
Ellie ^{Pro}	●	-	●	-	●	●	-	-	●	●	●	●	●	-	●	●	●	●	●	-	●	●
Fan	●	-	●	●	●	●	●	-	●	●	●	●	●	-	●	●	●	●	●	-	●	●
Mickey	●	-	●	-	●	●	●	-	●	●	●	●	●	-	●	●	●	●	●	-	●	●
MyTurn Sofa	●	-	●	-	●	●	-	-	●	●	●	●	●	-	●	●	●	●	●	-	●	●
Noor	●	●	●	●	●	●	●	●	●	●	●	●	●	●	●	●	●	●	●	●	●	●
Noor F	●	-	-	-	●	-	●	-	-	●	-	●	●	●	●	●	●	●	●	●	●	●
Normo	●	-	●	-	●	●	-	-	●	●	●	●	●	-	●	●	●	●	●	-	●	●
Nu	●	-	●	-	●	●	●	-	●	●	●	●	●	-	●	●	●	●	●	-	●	●
October	●	●	●	-	●	●	●	-	●	●	●	●	●	-	●	●	●	●	●	-	●	●
Revo	●	-	●	-	●	●	-	-	●	●	●	●	●	-	●	●	●	●	●	-	●	●
SoftBox	●	-	●	-	●	●	●	-	●	●	●	●	●	-	●	●	●	●	●	-	●	●
Sorriso	●	-	●	-	●	●	●	-	●	●	●	●	●	-	●	●	●	●	●	-	●	●
Trillo ^{Pro}	●	-	●	-	●	●	-	-	●	●	●	●	●	-	●	●	●	●	●	-	●	●
Vancouver Lite	●	-	●	-	●	●	●	-	●	●	●	●	●	-	●	●	●	●	●	-	●	●
Vancouver Oto	●	-	●	●	●	●	●	-	●	●	●	●	●	-	●	●	●	●	●	-	●	●
Wall In	●	-	●	-	●	●	●	-	●	●	●	●	●	-	●	●	●	●	●	-	●	●
Zoo	●	-	●	-	●	●	●	-	●	●	●	●	●	-	●	●	●	●	●	-	●	●
Cushions	●	-	●	-	●	●	-	-	●	●	●	●	●	-	●	●	●	●	●	-	●	●

Fabrics - Extended

Lead time 30-40 working days

Gaja C2C (PG 3)	Passion (PG 4)	Step Melange (PG 3)	GU											Kvadrat								
			Arndal (PG 4)	Bardal (PG 4)	Gandal + (PG 4)	Heidal (PG 4)	Hemsedal (PG 3)	Mandal (PG 4)	Morgedal (PG 4)	Setesdal (PG 4)	Sirdal (PG 4)	Suldal (PG 4)	Atlas (PG 3)	Canvas (PG 4)	Coda (PG 6)	Divina Melange (PG 5)	Divina (PG 5)	Divina MD(PG 5)	Flord 2 (PG 4)			
●	●	●	●	●	●	●	●	●	●	●	●	●	●	●	●	●	●	●	●	●	Ana	
●	-	●	●	●	●	●	●	-	●	●	●	●	●	●	-	●	●	●	-	●	Ariz	
-	-	●	-	-	-	-	-	-	-	-	-	-	●	●	-	●	●	-	-	●	Bit	
-	-	●	●	●	●	●	●	-	●	●	●	●	●	●	●	●	●	●	-	●	Chic	
-	-	●	●	●	●	●	●	-	●	●	●	●	●	●	●	-	●	●	-	●	Chic Lounge	
-	-	●	●	●	●	●	●	-	●	●	●	●	●	●	-	●	●	●	-	●	Com	
-	-	●	●	●	●	●	●	-	●	●	●	●	●	●	-	●	●	●	-	●	Ellie ^{Pro}	
-	-	●	●	●	●	●	●	-	●	●	●	●	●	●	●	●	●	●	-	●	Fan	
-	-	●	●	●	●	●	●	-	●	●	●	●	●	●	◇	◇	◇	●	-	●	Mickey	
-	-	●	●	●	●	●	●	-	●	●	●	●	●	●	●	●	●	●	-	●	MyTurn Sofa	
●	●	●	●	●	●	●	●	●	●	●	●	●	●	●	●	●	●	●	●	●	Noor	
●	-	●	●	●	-	●	●	-	●	●	●	●	-	-	●	●	●	●	●	●	Noor F	
-	-	●	●	●	●	●	●	-	●	●	●	●	●	●	●	●	●	●	-	●	Normo	
-	-	●	●	●	●	●	●	-	●	●	●	●	●	●	●	●	●	●	-	●	Nu	
-	-	●	-	-	-	-	-	-	-	-	-	-	●	●	●	●	●	-	-	●	October	
-	-	●	-	-	-	●	-	-	-	-	-	-	●	●	●	●	●	-	-	●	Revo	
-	-	●	●	●	●	●	●	-	●	●	●	●	●	●	●	●	●	●	-	●	SoftBox	
-	-	●	-	-	-	-	-	-	-	-	-	-	●	●	●	●	●	-	-	●	Sorriso	
-	-	●	-	-	-	-	-	-	-	-	-	-	●	●	-	●	●	-	-	●	Trillo ^{Pro}	
-	-	●	●	●	●	●	●	-	●	●	●	●	●	●	●	●	●	●	-	●	Vancouver Lite	
-	-	●	●	●	●	●	●	-	●	●	●	●	●	●	●	●	●	●	-	●	Vancouver Oto	
-	-	●	●	●	●	●	●	-	●	●	●	●	●	●	●	●	●	●	-	●	Wall In	
-	-	●	-	-	-	-	-	-	-	-	-	-	●	●	-	●	●	-	-	●	Zoo	
-	-	●	-	-	-	-	-	-	-	-	-	-	●	●	●	●	●	-	-	●	Cushions	

Fabrics - Extended

Lead time 30-40 working days

- Legend: ● Possibility of making the product in the given upholstery
 ○ Possibility of making only the seat in the given upholstery
 □ No possibility of making the walls in the given upholstery
 ◇ Handle always in fabric Next
 - Impossibility of making a product in a given upholstery





















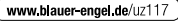



	Foss (PG 5)	Hallingdal 65 (PG 5)	Melange Nap (PG 4)	Naveit (PG 4)	Remix (PG 3)	Re-wood (PG 3)	Twill Weave (PG 5)	Tonus 4 (PG 5)	Nevotex	Illusion (PG 4)	Illusion Full Grain(PG 4)	Oniro	PUxx 1 (PG 3)	PUxx 2 (PG 3)	Spradling	Silvertex (PG 3)	Valencia (PG 1)	Svensson	Khaki (PG 3)	Node (PG 3)	Semi (PG 3)	Step (PG 3)
Ana	●	●	●	●	●	●	●	●		●	●		●	●		●	●		●	●	●	●
Ariz	●	●	●	-	●	●	●	●		○	-		○	○		●	●		●	-	●	●
Bit	-	-	●	-	●	●	●	-		-	-		-	-		●	●		-	-	●	-
Chic	-	●	●	-	●	●	●	●		-	-		-	-		●	●		-	-	●	-
Chic Lounge	-	●	●	-	●	●	●	●		-	-		-	-		-	-		-	-	●	-
Com	-	●	●	-	●	●	●	●		-	-		○	○		●	●		-	-	●	-
Ellie ^{Pro}	-	●	●	-	●	●	●	●		-	-		-	-		-	-		-	-	●	-
Fan	-	●	●	-	●	●	●	●		-	-		-	-		●	●		-	-	●	-
Mickey	-	●	●	-	●	●	●	●		-	-		-	-		◇	●		-	-	●	-
MyTurn Sofa	-	●	●	-	●	●	●	●		-	-		-	-		●	●		-	-	-	-
Noor	●	●	●	●	●	●	●	●		●	●		●	●		●	●		●	●	●	●
Noor F	-	●	●	-	●	●	●	-		-	-		-	-		-	-		-	●	●	●
Normo	-	●	●	-	●	●	●	●		-	-		-	-		-	-		-	-	●	-
Nu	●	●	●	-	●	●	●	●		-	-		-	-		●	●		-	-	●	-
October	-	-	●	-	●	●	●	-		-	-		-	-		●	●		-	-	●	-
Revo	-	-	●	-	●	●	●	-		-	-		-	-		●	●		-	-	●	-
SoftBox	-	●	●	-	●	●	●	●		-	-		-	-		□	□		-	-	●	-
Sorriso	-	-	●	-	●	●	●	●		-	-		-	-		●	●		-	-	●	-
Trillo ^{Pro}	-	-	●	-	●	●	●	-		-	-		-	-		●	●		-	-	●	-
Vancouver Lite	-	●	●	-	●	●	●	●		-	-		-	-		●	●		-	-	●	-
Vancouver Oto	-	●	●	-	●	●	●	●		-	-		-	-		●	●		-	-	●	-
Wall In	-	●	●	-	●	●	●	●		-	-		-	-		□	□		-	-	●	-
Zoo	-	-	●	-	●	●	●	-		-	-		-	-		●	●		-	-	●	-
Cushions	-	-	●	-	●	●	●	-		-	-		-	-		●	●		-	-	●	-

Fabrics - Extended

Lead time 30-40 working days

	Ana
	Ariz
	Bit
	Chic
	Chic Lounge
	Com
	Ellie ^{Pro}
	Fan
	Mickey
	MyTurn Sofa
	Noor
	Noor F
	Normo
	Nu
	October
	Revo
	SoftBox
	Sorriso
	Trillo ^{Pro}
	Vancouver Lite
	Vancouver Oto
	Wall In
	Zoo
	Cushions

Legend

 20,0	net weight		Ergonomie geprüft
 22,5	gross weight		GS (geprüfte Sicherheit)
 10	stacking (max. quantity)		Quality Office
 15	stacking on trolley for transportation (max. quantity)		MöBELFAKTA
	right-sided table top		The Blue Angel
	left-sided table top		
	joining in rows		Forest Stewardship Council®
	two-colour upholstery		Environmental Product Declarations (EPD)
	teflon glides		
	felt glides		
	special threads		
	clothes hanger		
	Mediaport		
	guarantee period		
	ISO 9001		
	ISO 14001		
	Chrom (III)		
	The mark of responsible forestry. Concerns only products indicated as FSC® certified.		

Office

Flokk AB
Rosenlundsgatan 40,
trapphus B, vån 3
118 52 Stockholm
Sweden

Social Media

Facebook
YouTube
Instagram
Pinterest
LinkedIn

Factory

Flokk AB
Vallgatan 1
571 41 Nässjö
Sweden

Price List

Valid from the 1st of April 2024
edition 1
Swivel chairs

All prices: SEK

ADDA RAMAVTAL

Contents

Profim VIOLLE     

Profim XENON     

Profim XENON NET     

Technical details



Fabrics and finishings

Profim Standard fabrics Fabrics

and finishings - Extended

Legend

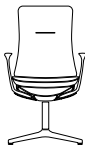
Swivel chairs

Item no	Base model +	Price Group (PG)	Price Group						Price
			0	①	②	③	④	⑤	
MLX130F000	Profim VIOLLE 130F <ul style="list-style-type: none"> • visitor • swivel • high backrest • 4-star base • base: white / black/ polished aluminum • non-arm version • teflon glides - universal 		8 271	8 740	9 233	9 603	11 124	10 475	11 870
MLX150F000	Profim VIOLLE 150F <ul style="list-style-type: none"> • visitor • swivel • high mesh backrest • 4-star base • base: white / black/ polished aluminum • non-arm version • teflon glides - universal 		7 778	8 006	8 271	8 602	8 897	9 005	9 559

Accessories/Options/Surcharges:

7BASC006	Base: lightgray (Only for: 130SFL, 131SFL, 150SFL, 151SFL)	108
7BASC002	Base: white (Only for: 130SFL, 131SFL, 150SFL, 151SFL)	734
7BASC003	Base: polished aluminum (Only for: 130SFL, 131SFL, 150SFL, 151SFL)	734
7ARMR016	Armrests P62PU - black (set) (Only for: 130SFL, 131SFL, 150SFL, 151SFL)	1 794
7ARMR017	Armrests P62PU - lightgrey (set) (Only for: 130SFL, 131SFL, 150SFL, 151SFL)	1 987
7ARMR001	Armrests - fixed, aluminum, polyurethane pad (set) (Only for: 130F, 150F)	1 854
7LUSU003	Lumbar support TYPE B - height and depth adjustable (Only for: 150SFL, 151SFL)	349
7HANG002	Clothes hanger (HA) black or light grey - maximum load 4 kg (Only for: 130SFL, 131SFL, 150SFL, 151SFL)	494
7PLAP003	Plastic colours - lightgrey (Only for: 130SFL, 131SFL, 150SFL, 151SFL)	542

0 price group: Evo

1 price group: Cura, Tonal, Xtreme

2 price group: Select

3 price group: Capture, Oceanic, Step, Synergy

4 price group: Steelcut 3, Steelcut Trio 3

Castors/glides:

- hard castors - for soft floors (set),
- soft castors - for hard floors (set),
- teflon glides - universal (set).

Glides in models 130F / 150F:

- standard - teflon glides (universal),
- option - felt glides (for hard floors).

When ordering please clearly indicate the chosen option.

Armrest P62PU black - height adjustable armrest (range 90 mm), sliding pad (range +/- 50 mm) with span option (+/- 28 mm), polyurethane pad.

Armrest PU - fixed, aluminum, polyurethane pad.

Seat covers can be made also for Rhythm and Runner upholstery. When ordering please clearly indicate the chosen option.

Gas lift with shock absorber - colour of column cover always the same as base colour.

Models Violle 130,150, 151 can be upholstered in Runner or Rhythm mesh.

Headrest may be covered in seat-upholstery or in Rhythm or Runner-mesh. Please clearly indicate on your order the chosen option.

Plastic elements: seat cover+adjustments levers, outer frame in mesh backrest, lumbar support, rear part of headrest.

Aluminium elements: armrest frame, backrest frame. It is not possible to mix different colours in particular group of elements.

In models Violle 130F / 150F gas lift with memory as standard (without height adjustment). Colour of column cover - always the same as base colour.

In models Violle 130F:

- base white and polished aluminium - cover colour lightgrey,

In models Violle 150F:

- cover colour always the same as frame of backrest.

In models with armrests:

- base white and polished aluminium, armpad lightgrey - cover colour lightgrey.

When ordering please clearly indicate the chosen option.



Item no	Base model +	Price Group (PG)	Price Group						Price
			0	①	②	③	④	⑤	

MBC021H000	Profim XENON 20H • visitor chair • 4-legged • base: black • non-arm version		3 002	3 352	3 532	3 673	4 507	4 327	5 399
------------	---	---	-------	-------	-------	-------	-------	-------	-------

MBC021V000	Profim XENON 20V • visitor chair • cantilever • stackable • base: black • non-arm version		3 134	3 497	3 640	3 785	4 653	4 435	5 542
------------	--	---	-------	-------	-------	-------	-------	-------	-------

Accessories/Options/Surcharges:

7BASC003	Base: polished aluminum (Only for: 10S, 10SFL, 10SL, 11S, 11SFL, 11SL)	734
7COPR002	Frames colours: MetallicPro, (Only for: 20H, 20V)	33
7CFRA001	Frame: chrome (Only for: 20H, 20V)	374
7ARMR006	Armrests P61PU - black (set) (Only for: 10S, 10SFL, 10SL, 11S, 11SFL, 11SL)	589
7ARMR003	Armrests P59PU (set) (Only for: 10S, 10SFL, 10SL, 11S, 11SFL, 11SL)	867
7ARMR001	Armrests - metal with a polypropylene pad (set) (Only for: 20H, 20V)	289
7TGAS005	Gas lift with shock absorber (Only for: 10S, 10SFL, 10SL, 11S, 11SFL, 11SL)	252
7HANG002	Clothes hanger (HA) - maximum load 4 kg (Only for: 10S, 10SFL, 10SL, 11S, 11SFL, 11SL)	434
7SBQU002	Quilting - front side of the seat (Q1) (Only for: 10S, 10SFL, 10SL, 11S, 11SFL, 11SL)	434
7SBQU003	Quilting - front of the backrest (Q2) (Only for: 10S, 10SFL, 10SL, 11S, 11SFL, 11SL)	517
7SEQU004	Quilting - front side of the seat (Q1) (Only for: 20H, 20V)	434

0 price group: Evo

1 price group: Cura, Tonal, Xtreme

2 price group: Select

3 price group: Capture, Oceanic, Step, Synergy

4 price group: Steelcut 3, Steelcut Trio 3

Castors/glides:

- hard castors - for soft floors (set),
- soft castors - for hard floors (set),
- teflon glides - universal (set).

Glides in models 20H / 20V:

- standard - teflon glides (universal),
- option - felt glides (for hard floors).

When ordering please clearly indicate the chosen option.

Armrest P61PU - height adjustable armrest (range 80 mm), polyurethane pad.

Armrest P59PU - height adjustable armrest (range 80 mm), sliding pad (+/- 50 mm) with span option (+/- 30 mm), polyurethane pad.

Armrests P61PU and P59PU are always black, irrespective of the colour of base.

J-bar (backrest bracket) - always in grey colour.

SmartADLS - patented solution and a unique feature of the Xenon collection ensuring proper support of the lower spine.

When ordering please clearly indicate the chosen option.

Quilting - extra charge to all price groups, lead time 30-40 working days.



www.blauer-engel.de/uz117

Item no	Base model +	Price Group (PG)	0	①	②	③	④	⑤	⑥	Price
MBC201H000	Profim XENON NET 20H • visitor chair • 4-legged • frame: black • non-arm version		3 015	3 256	3 412	3 549	4 327	3 785	4 423	

Item no	Base model +	Price Group (PG)	Price Group						Price
			0	①	②	③	④	⑤	
MBC201V000	Profim XENON NET 20V • visitor chair • cantilever • stackable • frame: black • non-arm version		3 148	3 400	3 545	3 687	4 435	3 894	4 544

Accessories/Options/Surcharges:

7BASC003	Base: polished aluminum	734
7COPR002	Frames colours: MetallicPro, (Only for: 20H, 20V)	33
7CFRA001	Frame: chrome (Only for: 20H, 20V)	374
7ARMR006	Armrests P61PU - black (set) (Only for: 100S, 100SFL, 100SL, 101S, 101SFL, 101SL, 110S, 110SFL, 110SL, 111S, 111SFL, 111SL)	589
7ARMR003	Armrests P59PU (set) (Only for: 100S, 100SFL, 100SL, 101S, 101SFL, 101SL, 110S, 110SFL, 110SL, 111S, 111SFL, 111SL)	867
7ARMR001	Armrests - metal with a polypropylene pad (set) (Only for: 20H, 20V)	289
7TGAS005	Gas lift with shock absorber (Only for: 100S, 100SFL, 100SL, 101S, 101SFL, 101SL, 110S, 110SFL, 110SL, 111S, 111SFL, 111SL)	252
7HANG002	Clothes hanger (Only for: 100S, 100SFL, 100SL, 101S, 101SFL, 101SL, 110S, 110SFL, 110SL, 111S, 111SFL, 111SL)	434
7SEQU004	Quilting - front side of the seat (Q1)	434

0 price group: Evo

1 price group: Cura, Tonal, Xtreme

2 price group: Select

3 price group: Capture, Oceanic, Step, Synergy

4 price group: Steelcut 3, Steelcut Trio 3

Castors/glides:

- hard castors - for soft floors (set),
- soft castors - for hard floors (set),
- teflon glides - universal (set).

Glides in models 20H / 20V:

- standard - teflon glides (universal),
- option - felt glides (for hard floors),

When ordering please clearly indicate the chosen option.

Armrest P61PU - height adjustable armrest (range 80 mm), polyurethane pad.

Armrest P59PU - height adjustable armrest (range 80 mm), sliding pad (+/- 50 mm) with span option (+/- 30 mm), polyurethane pad.

Armrests P61PU and P59PU are always black, irrespective of the colour of base.

Type of mesh: Runner, String. Please clearly indicate on your order the chosen option.

In models Xenon Net 110/111 headrest may be covered in seat-upholstery or in Runner-mesh. Please clearly indicate on your order the chosen option.

J-bar (backrest bracket) - always in grey colour.

SmartADLS - patented solution and a unique feature of the Xenon Net collection ensuring proper support of the lower spine.

When ordering please clearly indicate the chosen option.

Quilting - extra charge to all price groups, lead time 30-40 working days.



www.blauer-engel.de/uz117

Consumption of fabric and leather

The quantities below are only estimated. The real quantity of fabric- or leather-consumption may vary in accordance to the quantity of pieces on order. Please notice that before we accept any order in customer's own material we need to make sample trials. Please be aware that not every type of fabric/leather is suitable for upholstery. Volume of customer's own material must be agreed each time with Profim sales organization

Column A - Estimated consumption of fabric (roll width: 1,40 m)

Column B - Estimated consumption of leather (m²)

	A	B
Accis^{Pro}		
150	0,7	0,8

Action		
100, 110	1,5	2,0
105, 115	0,6	0,8
580	1,2	-

LightUp		
230, 330	1,2	-
250, 350	0,5	-

Motto		
10	1,4	-
11	1,8	-

MyTurn		
10	1,7	2,3
20	1,6	2,1

Veris		
10, 101	1,5	1,2
11, 111	1,8	1,2

Violle		
130SFL	1,8	1,5
131SFL	2,1	1,7
150SFL	0,6	0,6
151SFL	0,9	0,8
130F	1,8	1,5
150F	0,6	0,6

Xenon		
10	1,5	1,5
11	1,9	1,7

Xenon Net		
100, 101	0,7	0,7
110, 111	1,1	0,9

Measuring methodology

Swivel armchairs and chairs are measured with a mechanism adjusted in such a way that the seat is as much as it is possible positioned levelly, while the backrest vertically. Swivel armchairs and chairs are measured on their castors, whereas visitor and reception chairs on hard glides. The measurements are approximate and can differ depending on the product configuration.

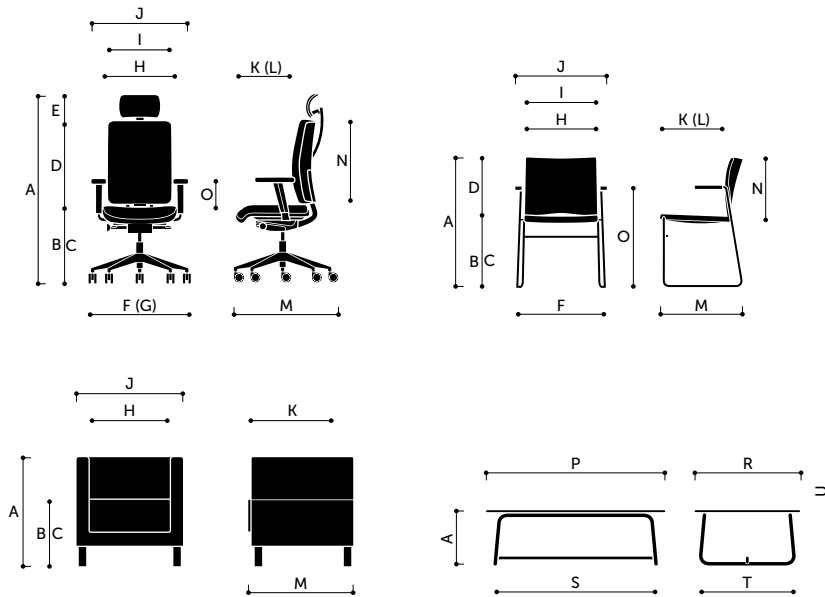

A - Total height

For products fitted with a gas lift - it is measured with gas lift's minimum and maximum extension. For products fitted with an additional backrest and headrest height adjustment - it is measured in both minimum and maximum positions of the backrest, headrest and gas lift.

B - Seat height

Measured at the highest point of the seat. For products fitted with a gas lift - it is measured with absorber's minimum and maximum extension.

C - Seat height with the burden

Seat measured according to EN standards (with seat burden). For products fitted with a gas lift - it is measured with gas lift's minimum and maximum extension.

D - Backrest height

Measured from the seat to the backrest upper edge. For products with adjustable backrest height - it is measured in the minimum and maximum position.

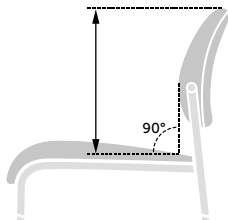

E - Headrest height

Measured from the backrest upper edge to the headrest upper edge. The headrest adjusted in maximum vertical position in relation to the upper and lower edge of the headrest. Measured in the headrest's minimum and maximum position.

F - Base, frame width

Measured at the uttermost points of the base according to the following figures.

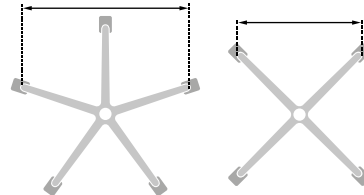

G - Base diameter

Measured according to the figure underneath.

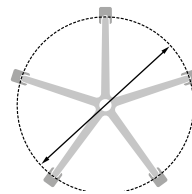

H - Seat width

Measured at the uttermost points of the seat.

I - Backrest width

Measured at the uttermost points of the backrest.

J - Total width

Measured at the uttermost points. For products fitted with adjustable armrests - it is measured with the armrests slid apart to maximum. For products fitted with armrests with adjustable pads - it is measured with the pads slid apart to maximum.

Measuring methodology

K - Seat depth

Measuring the distance between the uttermost point on the seat and the point it touches the backrest (the contact point is determined with a level positioned vertically to the backrest by projecting the S point from the backrest onto the seat) (1). For some shell chairs, where there is no distinct border-line between the seat and the backrest, the depth is measured on the bend halfway between the seat and the backrest (2). For products with additional adjustable seat depth - it is measured with minimum and maximum slide.

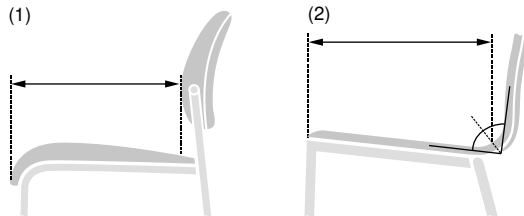

L - Seat (element) length

Measured at the uttermost points of the seat.

M - Total depth

Measured at the uttermost points. Swivel armchairs and chairs are measured according to the drawing underneath. For products with adjustable seat depth - it is measured with minimum and maximum slide.

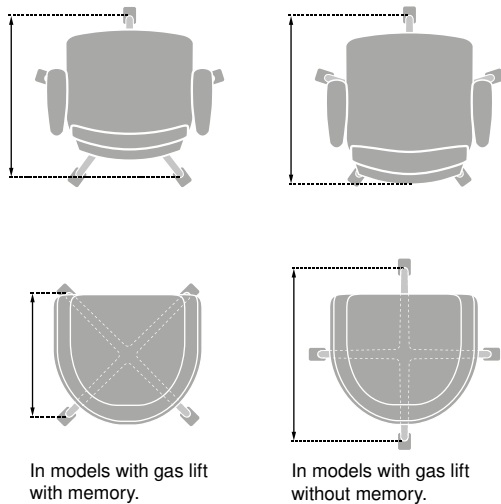

N - Backrest (element) length

Measured at the uttermost points of the backrest.

O - Armrest height

For swivel armchairs and chairs – it is measured from the seat surface to the armrest upper edge. For armrests with adjustable height – it is measured in the minimum and maximum position. For visitor chairs – it is measured from the floor to the armrest upper edge.

P - Table top length

Measured at the uttermost points of the table top.

R - Table top width

Measured at the uttermost points of the table top.

S - Table frame length

Measured at the uttermost points of the table frame.

T - Table frame width

Measured at the uttermost points of the table frame.

U - Table top thickness

Table top (element) thickness is measured.

Fabrics and finishings

Profim Standard fabrics

EVO - PRICE GROUP 0

Evo is a uni-coloured polyester crepe fabric. The irregular weave structure add shine and good stretch.

Composition: 100% polyester

Weight: 320 g/m²

Abrasion resistance: 180 000 Martindale (EN ISO 12947-2)

Flammability: BS EN 1021: 1-2 (Cigarette & match)

Light fastness: 4-5 (EN ISO 105-B02)

Rubbing fastness: 4-5 (Wet/Dry) (EN ISO 105-X12)

Pilling resistance: 5 (EN ISO 12945-2)

Environmental facts: EU Ecolabel, Oeko-Tex® Standard 100, ISO 14001 certified company

Design: Miranda Design Team

Produced in: Poland

Cleaning & disinfection: Dry cleaning with tetrachloroethylene and water solution of carbonate fluoride

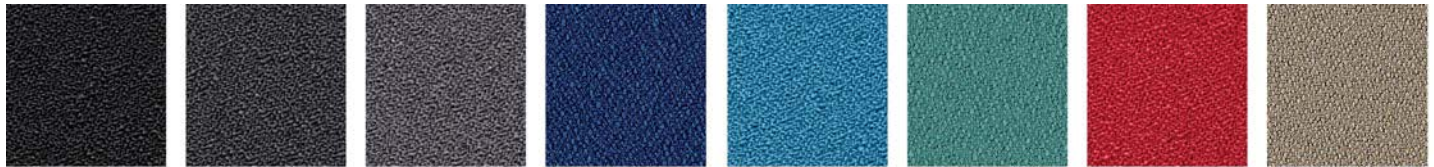

EVO011

EVO001

EVO014

EVO010

EVO025

EVO024

EVO005

EVO002

CURA (GABRIEL) - PRICE GROUP 1

Cura is a two-coloured fabric made from 98% post-consumer recycled polyester. It has a matt, slightly irregular and natural-looking texture where the dark, underlying grey fibers create a discreet yet vibrant melange effect. High durability and stretchability and its soft, voluminous touch make Cura suitable for both office and lounge furniture.

Composition: 98% post-consumer recycled polyester, 2% polyester

Weight: 420 g/m²

Abrasion resistance: 100 000 Martindale (EN ISO 12947-2)

Flammability: BS EN 1021: 1-2, BS 5852 0&1, CA TB 117-2013, ASTM E 84 Class I

Light fastness: 5-8 (EN ISO 105 - B02)

Rubbing fastness: 4-5/4-5 (Wet/Dry) (EN ISO 105X12)

Pilling: 4-5 (EN ISO 12945-2)

Environmental facts: EU Ecolabel, Oeko-Tex® Standard 100, Contains no Flame Retardant chemicals, ISO 14001 certified company

Design: Cenk Kivrikoglu

Produced in: Lithuania

Cleaning: Wash or dry cleaning, Can be disinfected with ethanol and is bleach-cleanable (For further info follow Gabriel´s cleaning guidelines – www.gabriel.dk)



CU60999

CU60109

CU60110

CU61168

CU66165

CU66170

CU66167

CU68182



CU68186

CU62083

TONAL (GABRIEL) - PRICE GROUP 1

Tonal is a post-consumer recycled polyester fabric in a two-coloured melange. It has a discreet textured look with a fusion of light and dark tones adding depth to the colours.

Composition: 99% post-consumer recycled polyester, 1% polyester

Weight: 315 g/lm

Abrasion resistance: 100 000 Martindale (EN ISO 12947-2)

Flammability: BS EN 1021: 1-2, BS 476 Part 7 class 1, CA TB 117-2013, ASTM E 84 Class I

Light fastness: 6-8 (EN ISO 105 - B02)

Rubbing fastness: 4-5/4-5 (Wet/Dry) (EN ISO 105X12)

Pilling: 4-5 (EN ISO 12945-2)

Environmental facts: EU Ecolabel, Oeko-Tex® Standard 100, Contains no Flame Retardant chemicals, ISO 14001 certified company

Design: Cenk Kivrikoglu

Produced in: Lithuania

Cleaning: Wash or dry cleaning. Can be disinfected with ethanol and is bleach-cleanable (For further info follow Gabriel's cleaning guidelines - www.gabriel.dk)

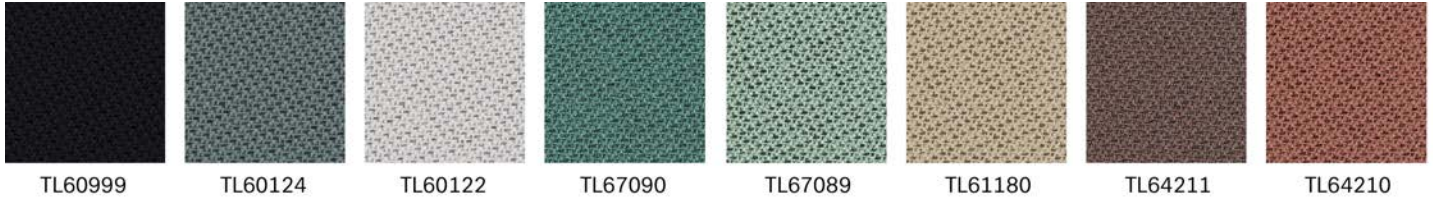

XTREME (CAMIRA) - PRICE GROUP 1

Xtreme is a crepe fabric made from 100% post-consumer recycled polyester that features exceptional Euro flammability performance. Extra stretch and structure gives an irregular, shiny finish.

Composition: 100% post-consumer recycled polyester

Weight: 310 g/m²

Abrasion resistance: >100 000 Martindale (EN ISO 12947-2)

Flammability: BS EN 1021: 1-2 (Cigarette & match), BS 7176 Low & Medium Hazard, BS 5852 Section 4 Crib 5, DIN 4102 B1, UNI 9175 Class 1 IM, NF D 60-013

Light fastness: 6 (EN ISO 105 - B02: 2013)

Rubbing fastness: 4/4 (Wet/Dry) (EN ISO 105X12)

Pilling: 5 (EN ISO 12945-2)

Environmental facts: EU Ecolabel, Oeko-Tex® Standard 100, Indoor Advantage™ "Gold", non metallic dyestuffs, ISO 14001 certified company.

Design: Camira Design Studio

Produced in: United Kingdom

Cleaning & disinfection: Washable to 60 °C and bleach cleanable (For further info follow Camira's cleaning guidelines - www.camirafabrics.com)

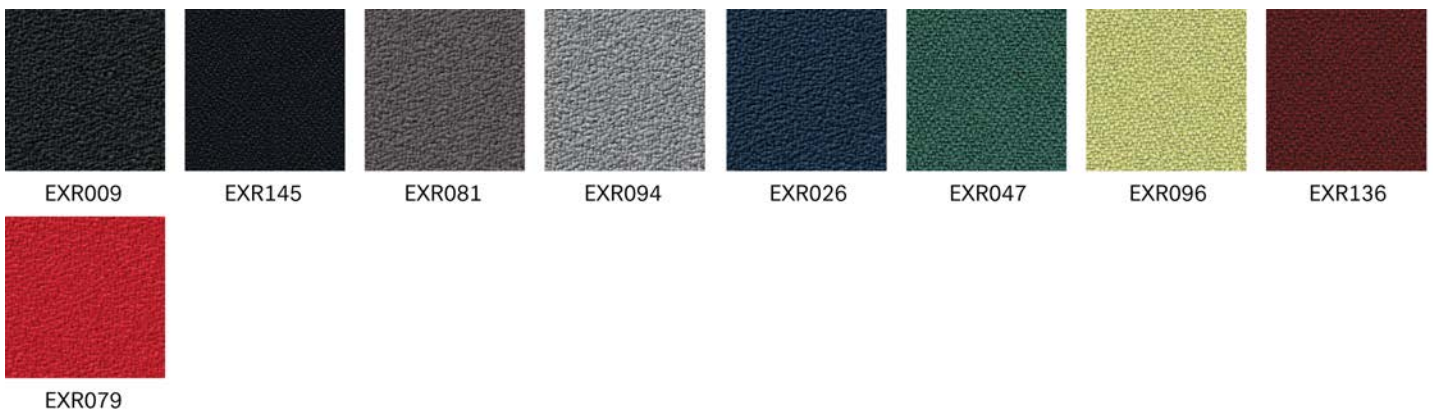

SELECT (GABRIEL) - PRICE GROUP 2

Select is a classic woolen fabric with a tightly woven relief structure, combining excellent softness, stretch and durability. Its rich texture with the interplay of light and shadow add depth in all the colours in the palette.

Composition: 85% New Zealand wool, 15% polyamide

Abrasion resistance: 200 000 Martindale (EN ISO 12947-2)

Flammability: BS EN 1021: 1-2, BS 5852 0&1, BS5852 Crib 5, CA TB 117-2013, IMO MSC 307(88) Annex 1 part 8/MED registration IMO

Light fastness: 5-8 (EN ISO 105 - B02)

Rubbing fastness: 4-5/4-5 (Wet/Dry) (EN ISO 105X12)

Pilling: 4 (EN ISO 12945-2)

Environmental facts: EU Ecolabel, Oeko-Tex® Standard 100, 100% free of heavy metals, ISO 14001 certified company

Design: Cenk Kivrikoglu

Produced in: Lithuania

Cleaning: Professional dry cleaning (For further info follow Gabriel's cleaning guidelines - www.gabriel.dk)

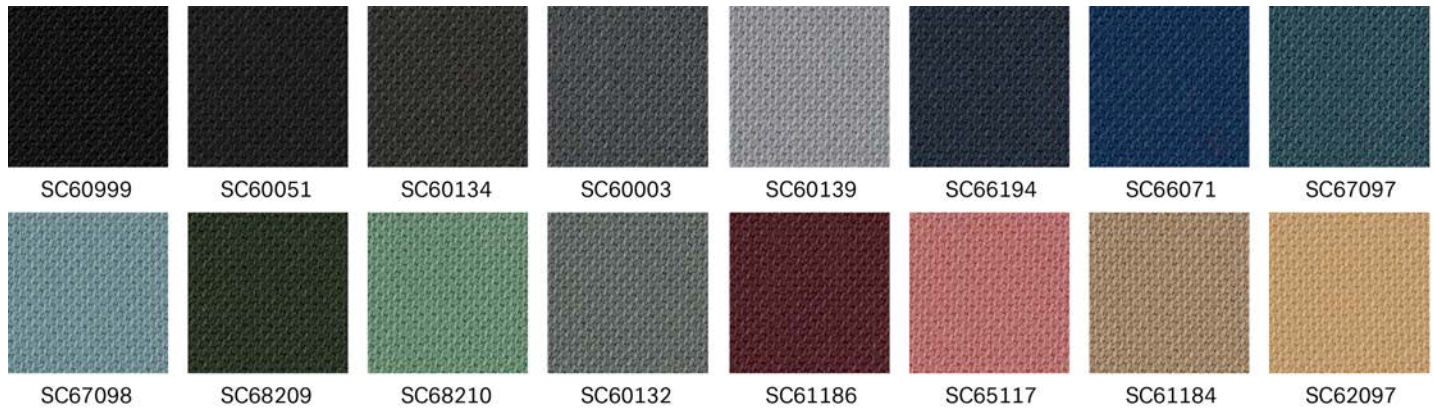

CAPTURE (GABRIEL) - PRICE GROUP 3

Capture is a lightly felted and multi-coloured wool fabric combining softness, stretch and strenght. It fuses light and dark colours to a refined melange pattern in subtle nuances, which add richness and depth to the design.

Composition: 85% New Zealand wool, 15% polyamide

Abrasion resistance: 200.000 Martindale (EN ISO 12947-2)

Flammability: BS EN 1021: 1-2 (Cigarette & match), BS 5852 Part 1 0,1 (Cigarette & match), CA TB 117-2013, Class Uno UNI 9175 Class 1 IM

Light fastness: 5-7 (EN ISO 105-B02)

Rubbing fastness: 4-5/4-5 (Wet/Dry) (EN ISO 105X12)

Pilling: 4-5 (EN-ISO 12945-2)

Environmental facts: EU Ecolabel, Oeko-Tex® Standard 100, 100% free of heavy metals, ISO 14001 certified company

Design: Cenk Kivrikoglu

Produced in: Lithuania

Cleaning: Professional dry cleaning (For further info follow Gabriel's cleaning guidelines - www.gabriel.dk)



OCEANIC (CAMIRA) - PRICE GROUP 3

Oceanic is made from 100 % post-consumer recycled polyester yarn where 90% are created from post-consumer plastic bottles diverted from landfill and 10% is upcycled marine plastic(from marine litter). It is a fabric born out of the SEAQUAL Initiative designed to combat marine plastic pollution and achieve a waste free environment. Oceanic has a two coloured diagonal structure with a matte surface and soft touch.

Composition: 100 % post-consumer recycled polyester, including 50% SEAQUAL yarn

Weight: 497 g/m² ±5%

Abrasion resistance: >100 000 Martindale (EN ISO 12947-2)

Flammability: BS EN 1021: 1-2 (Cigarette & match), BS 7176 Low, BS 7176 Medium Hazard with EnviroFlam5, CA TB 117-2013

Light fastness: 5 (EN ISO 105 - B02: 2013)

Rubbing fastness: 4/4 (Wet/Dry) (EN ISO 105X12)

Pilling: 4 (EN ISO 12945-2)

Environmental facts: EU Ecolabel, Oeko-Tex® Standard 100, Indoor Advantage™ "Gold", non metallic dyestuffs, ISO 14001 certified company.

Design: Camira Design Studio

Produced in: United Kingdom

Cleaning & disinfection: Washable at 60 °C and bleach cleanable (For further info follow Camira´s cleaning guidelines – www.camirafabrics.com)

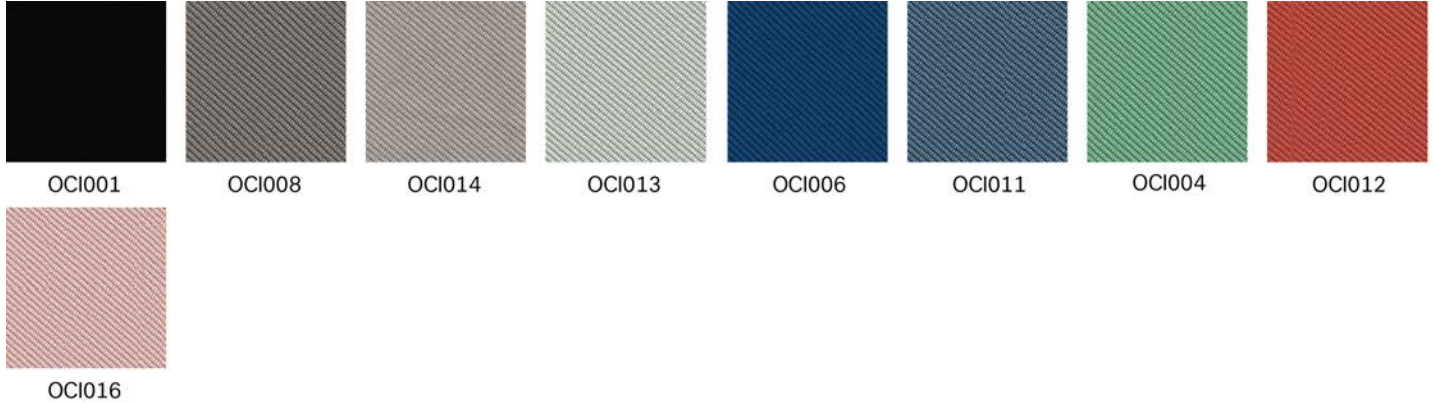

STEP (GABRIEL) - PRICE GROUP 3

Step is unique in both texture and performance. With its delicate surface, Step is perceived as vivid and interesting. The texture with the fire-resistant Trevira CS yarn ensures that the fabric is suited for use in environments with high fire safety and durability requirements.

Composition: 100% Trevira CS

Weight: 336 g/m²

Composition: 100% Trevira cs

Abrasion resistance: 100 000 Martindale (EN ISO 12947-2)

Flammability: BS EN 1021: 1&2 (Cigarette & match), BS 5852 0&1 (Cigarette & match), BS 5852 Crib 5, CA TB 117-2013, MED Certificate IMO, Class Uno UNI 9175 Class 1 EMME, ÖNORM

Light fastness: 5-7 (EN ISO 105 - B02)

Rubbing fastness: 4-5/4-5 (Wet/Dry) (EN ISO 105X12)

Pilling: 4-5 (EN ISO 12945-2)

Environmental facts: EU Ecolabel, Oeko-Tex® Standard 100, 100% free of heavy metals, ISO 14001 certified company

Design: Inger Mosholt Nielsen

Produced in: Lithuania

Cleaning: Professional dry cleaning (For further info follow Gabriel's cleaning guidelines www.gabriel.dk)

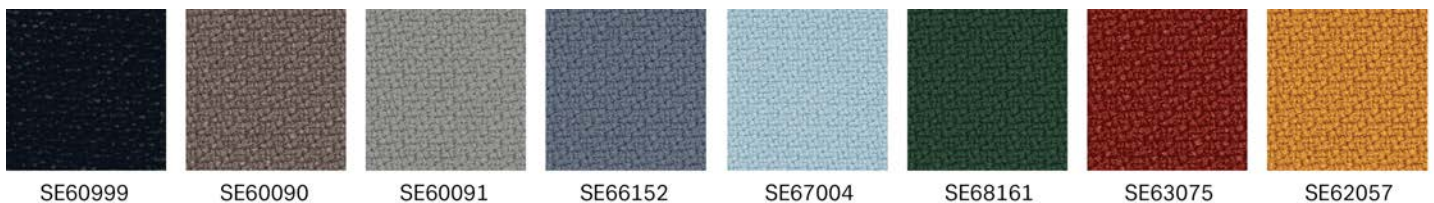

SYNERGY (CAMIRA) - PRICE GROUP 3

Epitomising natural simplicity, Synergy is a wool rich fabric which is at once both irresistibly soft and ultra-high performing. Delicately felted, with a beautifully relaxed drape, the understated aesthetics showcase the intriguing coloration of this considered textile.

Composition:

- 95% wool
- 5% polyamide
- **Weight:** 400 g/m²

Certificates:

- **Abrasion resistance:** 100000 Martindale cycles (BS-EN ISO 12947-2)
- **Pilling resistance:** 4 (BS-EN ISO 12945-2)
- **Flammability:** cigarette (BS-EN 1021-1)
- **Flammability:** match (BS-EN 1021-2)
- **Flammability:** (UNI 9175 Class 1IM)
- **Light fastness:** 5 (ISO 105-B02)
- **Maintenance:**
 - -vacuum regularly
 - -use dry-clean preparations
 - -do not bleach

Because of the fact that the fabric Synergy is composed of 95% natural fiber, each of the batches shows variations in shade, which may be visible in products of follow-up orders. Additionally, an inherent feature of all natural fibers is the tendency to delicate fabric pilling.

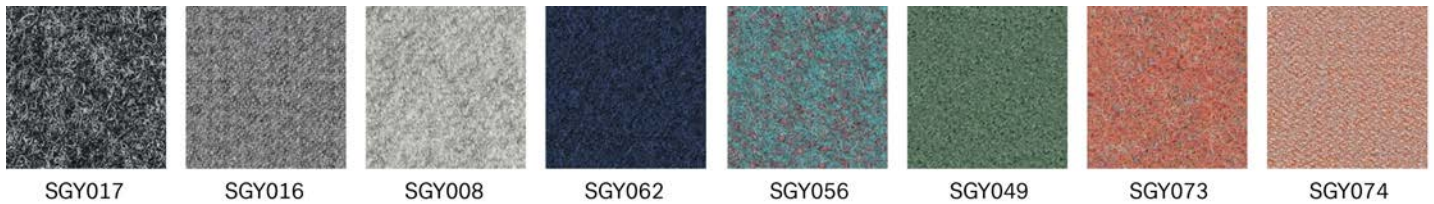

STEELCUT 3 (KVADRAT) - PRICE GROUP 4

Steelcut 3 is a unicoloured strong worsted wool and polyamide woven fabric, combining durability, soft touch and colour depth. The construction create a three-dimensional surface resembling small pyramids or steel points. Despite its complex weaving technique, it has a simple and precise expression.

Composition: 90% worsted new wool, 10% polyamide

Weight: 825 g/lm

Abrasion resistance: 100 000 Martindale (EN ISO 12947-2)

Flammability: BS EN 1021: 1-2 (Cigarette & match, CA TB 117-2013, BS 5852 Crib 5 (with treatment), BS 5852 part 1, IMO FTP Code 2010 Part 8, NF D 60 013, NFPA 260, UNI 9175 1IM, ÖNORM B1/Q1, AS/NZS 3837 Class 2, ASTM E84 Class A Unadhered, ASTM 84 Class B Adhered

Light fastness: 5 6 (EN ISO 105-B02)

Rubbing fastness: 3-5/4-5 (Wet/Dry) (EN ISO 105X12)

Pilling: 3-4 (EN ISO 12945-2)

Environmental facts: EU Ecolabel, 100% free of heavy metals, ISO 14001 certified company, GREENGUARD Gold

Design: Frans Dijkmeijer, Giulio Ridolfo (updated colourways)

Produced in: United Kingdom

Cleaning: Professional dry cleaning with tetrachloroethylene, normal process (For further info follow Kvadrat´s cleaning guidelines – www.kvadrat.dk)

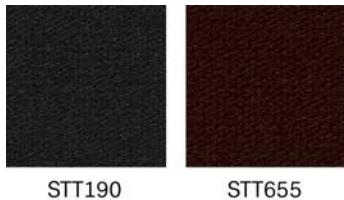

STEELCUT TRIO 3 (KVADRAT) - PRICE GROUP 4

Steelcut Trio 3 is a strong worsted wool and polyamide woven fabric, made with three different coloured yarns. The colours and the special weave create a three-dimensional surface where the colours seem to change depending on the angle of perspective. Like Steelcut 3, despite the complexity of the textile's innovative weave, it has a simple, precise expression.

Composition: 90% worsted new wool, 10% polyamide

Weight: 770 g/lm

Abrasion resistance: 100 000 Martindale (EN ISO 12947-2)

Flammability: BS EN 1021: 1-2 (Cigarette & match, CA TB 117-2013, . BS 5852 Crib 5 (with treatment), BS 5852 part 1, BS 5852 ignition source 3, IMO FTP Code 2010 Part 8, NF D 60 013, NFPA 260, UNI 9175 1IM, ÖNORM B1/Q1, AS/NZS 3837 Class 2, GB 50222 B1 with treatment (Chinese)

Light fastness: 6-7 (EN ISO 105-B02)

Rubbing fastness: 3-5/4-5 (Wet/Dry) (EN ISO 105X12)

Pilling: 4 (EN ISO 12945-2)

Environmental facts: EU Ecolabel, 100% free of heavy metals, ISO 14001 certified company, GREENGUARD Gold

Design: Frans Dijkmeijer, Giulio Ridolfo (updated colourways)

Produced in: United Kingdom

Cleaning: Professional dry cleaning with tetrachloroethylene, normal process (For further info follow Kvadrat's cleaning guidelines – www.kvadrat.dk)

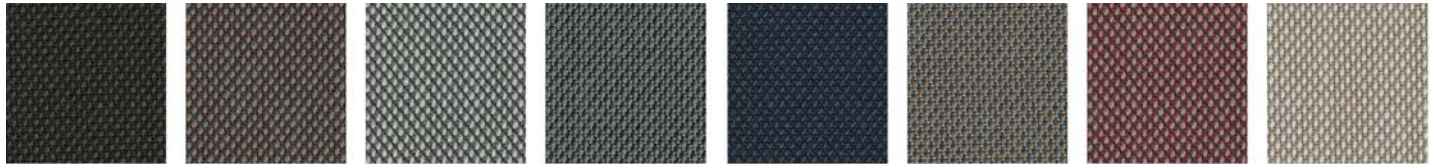

STT383

STT276

STT133

STT153

STT796

STT253

STT645

STT213

PALOMA SOFT (WOLLSDORF) - PRICE GROUP 6

High quality semi-aniline leather. All our standard colours from Paloma have a special finish adding a particular softness to the leather. Excellent friction and breathing properties. The surface may feature small scars and marks resulting from insect bites etc. These are proof of the natural origin of the product and are part of its character.

Flammability: BS EN 1021: 1-2 (Cigarette & match), BS 5852 Crib 5, IMO A.652 (16)

Light fastness: 6 (EN ISO 105-B02)

Rubbing: Wet 80/4 -Dry 2000/4 - Sweat 50/4 - ISO 11640

Finish-adhesion: 2.0 N/cm ISO 11644

Tear-strength: 20 N/mm DIN 53329- A

Environmental facts: Tanned without using chromium salts, BlueAngel, ECO2L-certificate, ISO 14001 certified company

Produced in: Austria

Animal Welfare: All hides are by-products from the meat and dairy industries, only use hides from healthy and uninjured animal. Following European standards as a minimum and the "Five Freedoms" of livestock as defined by FAWC (Farm Animal Welfare Council)

Cleaning: Follow the leather care guide from our supplier – www.wollsdorf.com



ATG56100

ATG55185

ATG55206

ATG55115

ATG55130

Fabrics and finishings

Mesh

Action

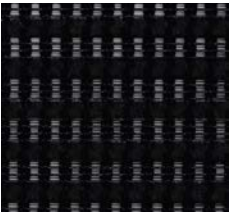

GZ-21

Mesh

Veris

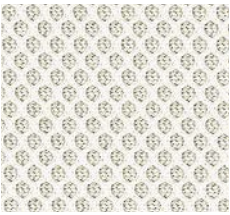

Runner 60061

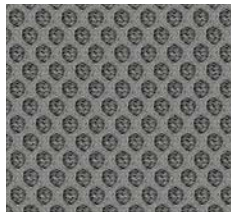

Runner 60011

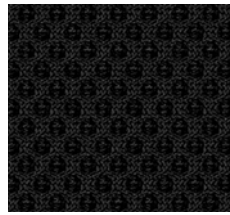

Runner 60999

Mesh

LightUp / Xenon Net



Runner 60061

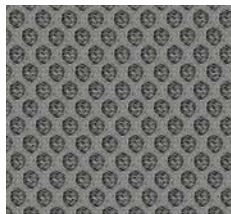

Runner 60011



Runner 60999

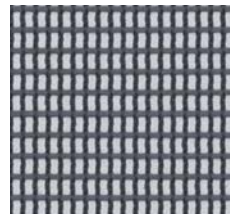

String 60118

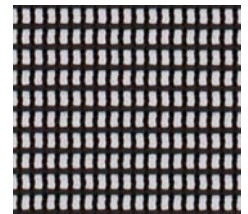

String 60999

Fabrics and finishings

Mesh

Accis^{Pro} / Violle

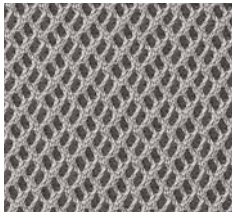

Rhythm 60165



Rhythm 60176



Rhythm 60999



Rhythm 66152

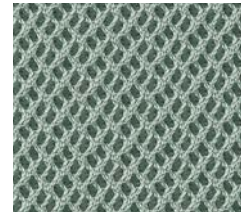

Rhythm 68121



Rhythm 63067



Runner 60061

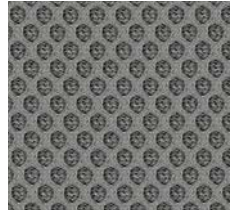

Runner 60011

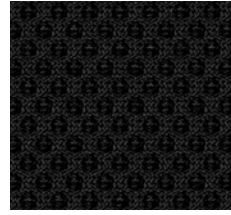

Runner 60999

Plastics

Accis^{Pro} / Light^{Up} / Violle

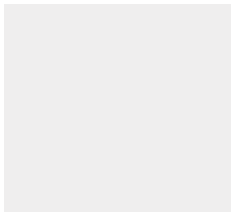

Light grey (RAL 7047)



Black

Fabrics - Extended

Lead time 30-40 working days

- Legend: ● Possibility of making the product in the given upholstery
 ○ Possibility of making only the seat in the given upholstery
 - Impossibility of making a product in a given upholstery

	Camira	Blazer (PG 3)	Era (PG 3)	Halcyon (PG 3)	Main Line Flax (PG 3)	Rivet (PG 3)	Urban (PG 3)	X2 (PG 3)	Gabriel	Breeze Fusion (PG 4)	Chill (PG 3)	Comfort+ (PG 5)	Crisp (PG 3)	Fame (PG 3)	Focus (PG 3)	Focus Melange (PG 3)	Go_Check (PG 3)	Go_Couture (PG 3)	Go_Uni (PG 3)	Just (PG 3)	Mica (PG 3)	Step Melange (PG 3)
Accis ^{Pro}	●	●	●	●	●	●	●	●	-	●	●	●	-	●	●	●	●	●	●	●	●	●
Action	●	●	-	●	●	●	●	●	-	●	●	●	-	●	●	●	●	●	●	●	●	●
LightUp	●	●	-	●	●	●	●	●	-	●	●	●	-	●	●	●	●	●	●	●	●	●
Motto	●	●	●	●	●	●	●	●	●	●	●	●	●	●	●	●	●	●	●	●	●	●
MyTurn	●	●	-	●	●	●	●	●	●	●	●	●	●	●	●	●	●	●	●	●	●	●
Veris Net	●	●	●	●	●	●	●	●	-	●	●	●	-	●	●	●	●	●	●	●	●	●
Violle	●	●	●	●	●	●	●	●	-	●	●	●	-	●	●	●	●	●	●	●	●	●
Xenon	●	●	●	●	●	●	●	●	-	●	●	●	-	●	●	●	●	●	●	●	●	●
Xenon Net	●	●	●	●	●	●	●	●	-	●	●	●	-	●	●	●	●	●	●	●	●	●

Fabrics - Extended

Lead time 30-40 working days

Kvadrat												Sanwil	Softline (PG 1)	Skai					
	Atlas (PG 3)	Canvas (PG 4)	Coda (PG 6)	Divina Melange (PG 5)	Divina (PG 5)	Divina MD(PG 5)	Hallingdal 65 (PG 5)	Melange Nap (PG 4)	Remix (PG 3)	Revive (PG 3)	Re-wool (PG 3)				Twill Weave (PG 5)	Palena (PG 3)	Palma (PG 3)	Parolega (PG 3)	Sotega (PG 3)
	●	●	●	●	●	-	-	●	●	●	●	●	●		●	●	●	●	Accis ^{Pro}
	●	●	-	●	●	-	-	●	●	●	●	●	●		●	-	●	●	Action
	●	●	○	○	○	-	-	●	●	●	○	○	●		○	-	○	●	LightUp
	●	●	-	●	●	●	●	●	●	●	●	●	●		●	●	●	●	Motto
	●	●	●	●	●	●	●	●	●	●	●	●	●		-	-	●	-	MyTurn
	●	●	-	●	●	-	-	●	●	●	●	●	●		●	●	●	●	Veris Net
	●	●	●	●	●	-	-	●	●	●	●	●	●		●	●	●	●	Violle
	●	●	●	●	●	-	-	●	●	●	●	●	●		●	●	●	●	Xenon
	●	●	●	●	●	-	-	●	●	●	●	●	●		●	●	●	●	Xenon Net



























Fabrics - Extended

Lead time 30-40 working days

- Legend:
- Possibility of making the product in the given upholstery
 - Possibility of making only the seat in the given upholstery
 - Impossibility of making a product in a given upholstery

	Spradling					Svensson			Textafoam	
	Chronos (PG 3)	Silvertex (PG 3)	Silvertex B1 (PG 3)	Valencia B1 (PG 3)		Semi (PG 3)	Velvet (PG 1)			
Accis ^{Pro}	●	●	●	●		●		●		
Action	○	●	●	●		●		-		
LightUp	○	○	●	●		●		●		
Motto	●	●	●	●		●		●		
MyTurn	-	●	-	-		●		-		
Veris Net	●	●	●	●		●		-		
Violle	●	●	●	●		●		●		
Xenon	●	●	●	●		●		●		
Xenon Net	●	●	●	●		●		●		

Legend

 20,0	net weight		Ergonomie geprüft
 22,5	gross weight		GS (geprüfte Sicherheit)
 10	stacking (max. quantity)		Quality Office
 15	stacking on trolley for transportation (max. quantity)		MöBELFAKTA
	right-sided table top		The Blue Angel
	left-sided table top		
	joining in rows		Forest Stewardship Council®
	two-colour upholstery		Environmental Product Declarations (EPD)
	teflon glides		
	felt glides		
	special threads		
	clothes hanger		
	Mediaport		
	guarantee period		
	ISO 9001		
	ISO 14001		
	Chrom (III)		
	The mark of responsible forestry. Concerns only products indicated as FSC® certified.		

Office

Flokk AB
Rosenlundsgatan 40,
trapphus B, vån 3
118 52 Stockholm
Sweden

Social Media

Facebook
YouTube
Instagram
Pinterest
LinkedIn

Factory

Flokk AB
Vallgatan 1
571 41 Nässjö
Sweden