

# Price List

Valid from the 1st of April 2024  
edition 1

All prices: SEK

**ADDA RAMAVTAL**

# SENAB

## Färgmarkeringar och/eller symboler för hållbara alternativ i prislistan:

### Mörkgrön markering eller symbol

Miljömärkt produkt – Möbler där hela den sammansatta varan har en typ 1 miljömärkning enligt ISO 14024 med Svanen, Möbelfakta, EU Ecolabel eller annan likvärdig märkning.

### Ljusgrön markering eller symbol

Hållbarhetsmärkt produkt eller beståndsdel – Möbler där hela eller delar av den sammansatta varan är hållbarhetsmärkt, exempelvis med FSC, EU Ecolabel eller OEKO-TEX®. Leverantören ska kunna ge mer detaljerad information om vilka delar eller variationer som är hållbarhetsmärka vid begäran.

### Orange markering eller symbol

Klimatberäknad produkt – Produkt med dokumenterad miljövarudeklaration (EPD) enligt ISO 14025.

### Lila markering eller symbol

Produkt med återvunnet eller förnybart material (enligt definitionerna i ISO 14021). Leverantören ska kunna ge information om andel (%) återvunnet och/eller förnybart (biobaserat) vid begäran. Märkning av återvinningsbart material utgår.

### Blå markering eller symbol

Demonterbar produkt – Produkt som är demonterbar till olika komponenter och beståndsdelar som i första hand möjliggör återbruk och i andra hand materialåtervinning när produkten nått sin fulla livslängd. Produkten ska vara designad för renovering, det vill säga att det ska vara enkelt att reparera och byta ut moduler, komponenter och beståndsdelar som slits över tid. Exempelvis ska ytskikt, som bordsskivor, textil och stoppning kunna tas isär, avlägsnas och ersättas med hjälp av vanligt förekommande manuella verktyg, ej specialverktyg. Enklare reparationer och utbytesarbeten ska kunna utföras av en lekman. Om det krävs fackmanakunskap för mer avancerade arbeten ska det framgå av anvisningarna som leverantören ska kunna ge vid begäran. Anvisningarna ska innehålla en sprängskiss, steg för steg beskrivning inklusive vilka verktyg som krävs samt hur möbelns ingående delar bör källsorteras.

# Contents

## Order entry specifications

Profim MICKEY    

Profim TRILLO PRO     

## Visitor chairs

Profim ANA     

Profim ARIZ    

Profim BIT    

Profim COM    

Profim NOOR 4-LEG     

Profim NOOR SLEDGEBASE     

Profim NOOR FOOTBASE     

Profim NOOR WOODEN LEGS     

Profim NOOR UP     

Profim NORMO     

Profim ZOO    

## Sofas, armchairs, modular systems

Profim CHIC    

Profim CHIC LOUNGE     

Profim ELLIE PRO     

Profim FAN     

Profim NU    

Profim REVO     

Profim SORRISO    

Profim VANCOUVER LITE     

Profim VANCOUVER OTO     

Profim WALL IN    

## Tables, coat stands and accessories

Profim ALLROUND  

Profim EMINENT  

Profim REVO TABLES     

Profim STANDARD FOLDING TABLE   

Profim U-CONNECT   

Profim SEVEN    

## Technical details

### Fabrics and finishings

Profim Standard fabrics

Fabrics and finishings - Extended Legend

Armchairs

Swivel chairs

Pouffes

# Profim MICKEY

## ITO Design

- It is a unique combination of a pouffe and a swivel stool with height adjustment
- Totally intuitive and easy to use
- Provides support by tilting from side to side (range of 10 degrees in each direction)
- Three colours of plastic parts
- Möbelfakta certificate - a guarantee of durability, safety, environmental care and social responsibility during the production process

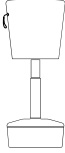
| Item no    | Base model +  | Price Group (PG)  | Price Group |       |       |       |       |       | Price |
|------------|---|---|-------------|-------|-------|-------|-------|-------|-------|
|            |   |   | 0           | ①     | ②     | ③     | ④     | ⑤     |       |
| MMC0000000 | Profim MICKEY <ul style="list-style-type: none"> <li>• stool, swivel with height adjustment and sideways tilt 10°</li> <li>• base: lightgrey (RAL 7047) / grey (RAL 7043) / beige (RAL 7036)</li> </ul> |  | 3 720       | 3 876 | 4 263 | 4 457 | 4 648 | 5 424 | 6 527 |

**0 price group: Evo**

**1 price group: Cura, Tonal, Xtreme**

**2 price group: Select**

**3 price group: Capture, Oceanic, Step, Synergy**

**4 price group: Steelcut 3, Steelcut Trio 3**

Base: lightgrey (RAL 7047) / grey (RAL 7043) / beige (RAL 7036) - when ordering please clearly indicate the chosen option.

Glides:

- teflon glides - universal (set).

When ordering please clearly indicate the chosen option.

The sides of the base can be made of:

- the same fabric as the seat,

- plastic in the same colour as the rest of plastic elements.

Please clearly indicate on your order the chosen option.

Handle for height adjustment is always made of the same fabric as the rest of the seat.





Plastic elements and the cover of the gas lift are made of different materials therefore their colour might vary slightly.



# Profim TRILLO PRO

## ITO Design

- Easily adjustable basic functions.
- Synchro self mechanism ensures adjustment to user's weight,
- Several versions to choose from: backrest in plastic or with upholstered pad, plastics in two colours,
- Blue Angel certificate - confirms that our chair is environmentally friendly

| Item no    | Base model +  | Price Group (PG)  | 0     | ①     | ②     | ③     | ④     | ⑤     | Price |
|------------|---|---|-------|-------|-------|-------|-------|-------|-------|
| MSX200ST00 | Profim TRILLO PRO 20ST<br><ul style="list-style-type: none"> <li>• plastic backrest</li> <li>• self mechanism</li> <li>• 5-star base</li> <li>• base: black</li> </ul>  |    | 2 782 | 3 010 | 3 118 | 3 242 | 3 504 | 3 616 |       |
| MSX210ST00 | Profim TRILLO PRO 21ST<br><ul style="list-style-type: none"> <li>• plastic backrest with upholstered pad</li> <li>• self mechanism</li> <li>• 5-star base</li> <li>• base: black</li> </ul>   |    | 3 252 | 3 576 | 3 791 | 3 943 | 4 504 | 4 398 |       |
| MSX200HS00 | Profim TRILLO PRO 20HST<br><ul style="list-style-type: none"> <li>• plastic backrest</li> <li>• self mechanism</li> <li>• 4-star base, high</li> <li>• base: black / white / graphite / polished aluminum / MetallicPro</li> </ul>                      |  | 3 780 | 4 036 | 4 168 | 4 327 | 4 582 | 4 837 |       |
| MSX210HS00 | Profim TRILLO PRO 21HST<br><ul style="list-style-type: none"> <li>• plastic backrest with upholstered pad</li> <li>• self mechanism</li> <li>• 4-star base, high</li> <li>• base: black / white / graphite / polished aluminum / MetallicPro</li> </ul> |  | 4 279 | 4 655 | 4 910 | 5 105 | 5 712 | 5 688 |       |

### Accessories/Options/Surcharges:

|          |  |     |
|----------|--|-----|
| 7BASC006 | Base: lightgray (Only for: MSX200ST00, MSX210ST00) | 230 |
|----------|--|-----|

**0 price group: Evo**

**1 price group: Cura, Tonal, Xtreme**

**2 price group: Select**

**3 price group: Capture, Oceanic, Step, Synergy**

**4 price group: Steelcut 3, Steelcut Trio 3**

Castors/glides:

- glides (set)
- hard castors - for soft floors (set),
- soft castors - for hard floors (set),

Plastic colours:- black, grey (RAL 7043), light grey (RAL 7047).

Plastic elements: backrest and armrests.

In models 20HST / 21HST:

- base colour black / MetallicPro - plastic elements black, castors black,
- base colour white - plastic elements lightgrey (RAL 7047), castors lightgrey,
- base colour graphite - plastic elements black or grey (RAL 7043), castors black,
- base colour polished aluminium - plastic elements black, grey (RAL 7043) and castors black or plastic elements light grey (RAL 7047) and castors lightgrey.

Please clearly indicate on your order the chosen option.



[www.blauer-engel.de/uz117](http://www.blauer-engel.de/uz117)



Visitor chairs



# Profim ANA

Tias Eckhoff

- Polypropylene (PP) shell in various colours.

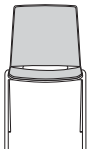
| Item no                                | Base model +  | Price Group (PG)   | Price Group |       |       |       |       |       | Price |     |
|--|---|--|-------------|-------|-------|-------|-------|-------|-------|-----|
|  |   |  | 0           | ①     | ②     | ③     | ④     | ⑤     |       | ⑥   |
| 4340                                   | Profim ANA 4340<br>• Without upholstery   |   |             |       |       |       |       |       |       | 742 |
| 4340s                                  | Profim ANA 4340s<br>• Upholstered seat  |   | 1 188       | 1 193 | 1 250 | 1 405 | 1 606 | 1 808 | 2 462 |     |
| 4340sr                                 | Profim ANA 4340sr<br>• Upholstered seat and back                                    |  | 1 552       | 1 589 | 1 634 | 1 955 | 2 385 | 2 730 | 3 730 |     |
| <b>Accessories/Options/Surcharges:</b> |   |  |             |       |       |       |       |       |       |     |
| 3YES                                   | Linking device, welded. Must be specified at time of order. Can not be retrofitted. |  |             |       |       |       |       |       |       | 124 |
| PD303                                  | Felt glides - 4 units.  |  |             |       |       |       |       |       |       | 39  |

**0 price group: Alba, Evo, Next,**

**1 price group: Cura, Tonal, Xtreme**

**2 price group: Select**

**3 price group: Capture, Oceanic, Step, Synergy**

**4 price group: Steelcut 3, Steelcut Trio 3**

Frame of 19 x 1.5 mm tubular steel available in various colours.

Weight 3.7 kg model 4340.

Height: Seat 430 mm, Back 400 mm, Chair width 490 mm, Chair height 825 mm, Chair depth 515 mm.

Stackable up to 12 chairs without upholstery (height: 1.83 m), 10 chairs with seat upholstery (height: 1.65 m) and 7 chairs with seat and back upholstery.

Can be linked together using linking device - see options.

Table suspension Profim Ana. See Profim Eminent table.

Graphite shell colour in recycled PP.



S=Standard Collection – normal delivery time from factory 10-15 working days. Applicable when all component options (fabric, shell, frame/legs) are standard(S).





E=Extended Collection – normal delivery time from factory 20-30 working days. Applicable when any or all component options selected are extended (E).





For larger orders, please contact Customer Service for delivery details.



# Profim ARIZ

- Wide configuration possibilities with several plastic colours and a wide range of upholstery fabrics
- Plastic, upholstered, and mesh versions.
- Version with comfortable armrest available
- Possibility of high stacking (up to 45 pieces on a special trolley for chair transport)
- Option to join in rows, mount writing top and newspaper basket
- Möbelfakta certificate - a guarantee of durability, safety, environmental care and social responsibility during the production process

| Item no    | Base model +  | Price Group (PG)  | 0    | ①    | ②    | ③    | ④    | ⑤    | Price |
|------------|---|---|------|------|------|------|------|------|-------|
| MWE500V000 | Profim ARIZ 550V<br>• plastic seat and backrest<br>• frame: black                 |    |      |      |      |      |      |      | 1775  |
| MWE550V000 | Profim ARIZ 555V<br>• plastic seat<br>• mesh backrest<br>• frame: black           |    |      |      |      |      |      |      | 2115  |
| MWE600V000 | Profim ARIZ 560V<br>• upholstered seat<br>• plastic backrest<br>• frame: black    |  | 2005 | 2139 | 2248 | 2334 | 2540 | 2613 |       |
| MWE700V000 | Profim ARIZ 570V<br>• upholstered seat and backrest<br>• frame: black             |  | 2382 | 2625 | 3002 | 3124 | 3902 | 3476 |       |
| MWE750V000 | Profim ARIZ 575V<br>• upholstered seat<br>• mesh backrest<br>• frame: black       |  | 2395 | 2540 | 2638 | 2735 | 2953 | 3063 |       |
| MWE500CV00 | Profim ARIZ 550CV<br>• bar stool<br>• plastic seat and backrest<br>• frame: black |  |      |      |      |      |      |      | 2467  |

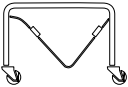
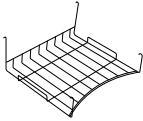
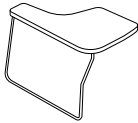
| Item no    | Base model +   | Price Group (PG)  | 0     | ①     | ②     | ③     | ④     | ⑤     | Price |
|------------|--|---|-------|-------|-------|-------|-------|-------|-------|
| MWE550CV00 | Profim ARIZ 555CV<br>• bar stool<br>• plastic seat<br>• mesh backrest<br>• frame: black        |    |       |       |       |       |       |       | 2722  |
| MWE600CV00 | Profim ARIZ 560CV<br>• bar stool<br>• upholstered seat<br>• plastic backrest<br>• frame: black |    | 2 662 | 2 820 | 2 953 | 3 063 | 3 246 | 3 428 |       |
| MWE700CV00 | Profim ARIZ 570CV<br>• bar stool<br>• upholstered seat and backrest<br>• frame: black          |    | 3 039 | 3 318 | 3 695 | 3 841 | 4 594 | 4 279 |       |
| MWE750CV00 | Profim ARIZ 575CV<br>• bar stool<br>• upholstered seat<br>• mesh backrest<br>• frame: black    |  | 3 051 | 3 233 | 3 330 | 3 464 | 3 646 | 3 853 |       |
| MWE000W000 | Profim ARIZ Chairs' trolley (W)  |  |       |       |       |       |       |       | 3 659 |
| MPDWEKO000 | Profim ARIZ Newspapers bin (K)   |  |       |       |       |       |       |       | 438   |
| MPDWEBL000 | Profim ARIZ Table top (B)  |  |       |       |       |       |       |       | 1 373 |

### Accessories/Options/Surcharges:

|          |   |       |
|----------|---|-------|
| 7COPR002 | Frames colours: MetallicPro, White RAL 9016, Deep Green RAL 6004, Navy Blue RAL 5003, Burgundy RAL 3005, Salvia/Green RAL 6021, Blue RAL 5014, Terracota RAL 3012 (Only for: 550CV, 550V, 555CV, 555V, 560CV, 560V, 570CV, 570V, 575CV, 575V) | 36    |
| 7COPR003 | Frames colours: Lightgrey NCS S 2500-N; Grey NCS S 6500-N (Only for: 550CV, 555CV, 555V, 560CV, 560V, 570CV, 570V, 575CV, 575V)   | 218   |
| 7COPR003 | Frames colours: Lightgrey NCS S 2500-N; Grey NCS S 6500-N (Only for: 550V)  | 1 641 |
| 7ARMR001 | Armrests - metal, polypropylene pad (set) (Only for: 550V, 555V, 560V, 570V, 575V)  | 790   |

**0 price group: Evo**

**1 price group: Cura, Tonal, Xtreme**

**2 price group: Select**

**3 price group: Capture, Oceanic, Step, Synergy**

**4 price group: Steelcut 3, Steelcut Trio 3**

Glides:

- standard - teflon glides (universal),
- option - felt glides (for hard floors).

When ordering please clearly indicate the chosen option.

Colours of plastics:

black (CODE 01), white (CODE 20), gray blue (CODE 503), olive green (CODE 513), red (CODE 3020), navy (CODE 516), ashen (CODE 517).

In models Ariz 555/575 backrest frame only in colours: black, white and ashen.

Available versions with mesh backrest (in Ariz 555 model):

- black plastic seat (CODE 01) + black backrest frame (CODE 01) + black mesh,
- white plastic seat (CODE 20) + white backrest frame (CODE 20) + black mesh,
- ashen plastic seat (CODE 517) + ashen backrest frame (CODE 517) + black mesh.

In standard there is no option of different colours of backrest and seat.

Type of mesh: GZ.

Accessories only for 550V / 555V / 560V / 570V / 575V models:



- Chairs' trolley - frame colour is always black.
- Table top (B) - assembled on the left or right hand, available in chairs without armrests only, table top's frame colour is always chrome.
- Newspapers bin (K) - mounted under the seat, colour is always chrome.



# Profim BIT

- Cantilever- or leg-mounted version
- Stackable
- Option to join in rows
- Choice of plastic or upholstered seat and plastic, mesh or upholstered backrest

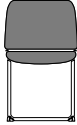
| Item no    | Base model +  | Price Group (PG)  | 0     | ①     | ②     | ③     | ④     | ⑤     | Price |
|------------|---|---|-------|-------|-------|-------|-------|-------|-------|
| MBT500H000 | Profim BIT 550H<br>• 4-legged<br>• plastic seat and backrest<br>• frame: black                    |    |       |       |       |       |       |       | 1775  |
| MBT500V000 | Profim BIT 550V<br>• cantilever<br>• plastic seat and backrest<br>• frame: black                  |    |       |       |       |       |       |       | 2248  |
| MBT550H000 | Profim BIT 555H<br>• 4-legged<br>• plastic seat<br>• mesh backrest<br>• frame: black              |  |       |       |       |       |       |       | 2188  |
| MBT550V000 | Profim BIT 555V<br>• cantilever<br>• plastic seat<br>• mesh backrest<br>• frame: black            |  |       |       |       |       |       |       | 2588  |
| MBT600H000 | Profim BIT 560H<br>• 4-legged<br>• seat upholstered pad<br>• plastic backrest<br>• frame: black   |  | 2 152 | 2 443 | 2 710 | 2 820 | 3 014 | 3 135 |       |
| MBT600V000 | Profim BIT 560V<br>• cantilever<br>• seat upholstered pad<br>• plastic backrest<br>• frame: black |  | 2 613 | 2 869 | 3 185 | 3 318 | 3 476 | 3 695 |       |

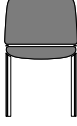
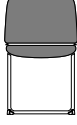
| Item no                                | Base model +   | Price Group (PG)  | 0     | ①     | ②     | ③     | ④     | ⑤     | Price |
|--|--|---|-------|-------|-------|-------|-------|-------|-------|
| MBT700H000                             | Profim BIT 570H<br>• 4-legged<br>• seat and backrest<br>• upholstered pads<br>• frame: black       |    | 2 431 | 2 808 | 3 391 | 3 525 | 3 998 | 3 938 |       |
| MBT700V000                             | Profim BIT 570V<br>• cantilever<br>• seat and backrest<br>• upholstered pads<br>• frame: black     |    | 2 856 | 3 282 | 3 841 | 3 986 | 4 461 | 4 449 |       |
| MBT750H000                             | Profim BIT 575H<br>• 4-legged<br>• seat upholstered pad<br>• mesh backrest<br>• frame: black       |    | 2 528 | 2 808 | 3 087 | 3 221 | 3 415 | 3 573 |       |
| MBT750V000                             | Profim BIT 575V<br>• cantilever<br>• seat upholstered pad<br>• mesh backrest<br>• frame: black     |  | 2 990 | 3 269 | 3 549 | 3 695 | 3 841 | 4 120 |       |
| MBT800H000                             | Profim BIT 580H<br>• 4-legged<br>• seat and backrest fully upholstered<br>• frame: black           |  | 2 431 | 3 367 | 4 631 | 4 813 | 5 445 | 5 360 |       |
| MBT800V000                             | Profim BIT 580V<br>• cantilever<br>• seat and backrest fully upholstered<br>• frame: black         |  | 2 856 | 3 829 | 5 092 | 5 287 | 5 907 | 5 907 |       |
| <b>Accessories/Options/Surcharges:</b> |  |   |       |       |       |       |       |       |       |
| 7ARMR001                               | Armrests - plastic, always black (set)   |   |       |       |       |       |       |       | 365   |
| 7SEQU001                               | Quilting - pad or front side of the seat (Q1) (Only for: MBT600H000, 560V, 570H, 570V, 575H, 575V) |   |       |       |       |       |       |       | 474   |
| 7BAQU001                               | Quilting - pad or front of the backrest (Q2) (Only for: 570H, 570V)                                |   |       |       |       |       |       |       | 389   |

0 price group: Evo

1 price group: Cura, Tonal, Xtreme

2 price group: Select

**3 price group: Capture, Oceanic, Step, Synergy**

**4 price group: Steelcut 3, Steelcut Trio 3**

Glides:

- standard - teflon glides (universal),
- option - felt glides (for hard floors).

When ordering please clearly indicate the chosen option.

Plastic of backrest and seat - always black.

Backrest mesh - always black.

Types of mesh: Runner.

Quilting - extra charge to all price groups, lead time 30-40 working days.













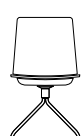





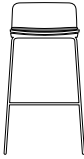

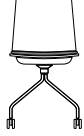
# Profim COM





## Paul Brooks

- Five types of bases allow any configuration
- The collection is completed with a barstool on a metal wire frame
- The square shape of the shell has four finishing options: plywood, with upholstered seat pad, with seat and backrest pad or fully upholstered
- The shell can come in different finishes: lacquered plywood, lined with natural veneer or HPL laminate which is scratch resistant

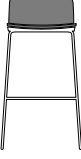
| Item no    | Base model +  | Price Group (PG)  | Price Group |   |   |   |   |   | Price |
|------------|---|---|-------------|---|---|---|---|---|-------|
|            |   |   | 0           | ① | ② | ③ | ④ | ⑤ |       |
| MCM120H000 | Profim COM K12H<br><ul style="list-style-type: none"> <li>• 4-legged</li> <li>• frame: black</li> <li>• plywood shell</li> </ul>  |    |             |   |   |   |   |   | 1441  |
| MCM120V000 | Profim COM K12V<br><ul style="list-style-type: none"> <li>• cantilever</li> <li>• wire frame</li> <li>• frame: black</li> <li>• stackable</li> <li>• plywood shell</li> </ul> |    |             |   |   |   |   |   | 1554  |
| MCM120CV00 | Profim COM K12CV<br><ul style="list-style-type: none"> <li>• barstool</li> <li>• frame: black</li> <li>• plywood shell</li> </ul>   |  |             |   |   |   |   |   | 2171  |
| MCM120HF00 | Profim COM K12HF<br><ul style="list-style-type: none"> <li>• "spider" frame</li> <li>• frame: black</li> <li>• plywood shell</li> </ul>                                       |  |             |   |   |   |   |   | 2648  |
| MCM120HS00 | Profim COM K12HS<br><ul style="list-style-type: none"> <li>• "spider" frame</li> <li>• frame: black</li> <li>• swivel</li> <li>• plywood shell</li> </ul>                     |  |             |   |   |   |   |   | 2947  |
| MCM120HC00 | Profim COM K12HC<br><ul style="list-style-type: none"> <li>• "spider" frame</li> <li>• frame: black</li> <li>• on castors</li> <li>• plywood shell</li> </ul>                 |  |             |   |   |   |   |   | 2994  |

| Item no    | Base model +   | Price Group<br>(PG)   | Price Group |      |      |      |      |      | Price |
|------------|--|---|-------------|------|------|------|------|------|-------|
|            |  |   | 0           | ①    | ②    | ③    | ④    | ⑤    |       |
| MCM220H000 | Profim COM K22H<br><ul style="list-style-type: none"> <li>• 4-legged</li> <li>• frame: black</li> <li>• plywood shell</li> <li>• seat upholstered pad</li> </ul>   |    | 1816        | 1891 | 2080 | 2175 | 2269 | 2648 | 2837  |
| MCM220V000 | Profim COM K22V<br><ul style="list-style-type: none"> <li>• cantilever</li> <li>• wire fame</li> <li>• frame: black</li> <li>• stackable</li> <li>• plywood shell</li> <li>• seat upholstered pad</li> </ul> |    | 1923        | 2003 | 2205 | 2304 | 2403 | 2805 | 3005  |
| MCM220CV00 | Profim COM K22CV<br><ul style="list-style-type: none"> <li>• barstool</li> <li>• frame: black</li> <li>• plywood shell</li> <li>• seat upholstered pad</li> </ul>  |    | 2516        | 2621 | 2883 | 3014 | 3145 | 3670 | 3933  |
| MCM220HF00 | Profim COM K22HF<br><ul style="list-style-type: none"> <li>• "spider" frame</li> <li>• frame: black</li> <li>• plywood shell</li> <li>• seat upholstered pad</li> </ul>                                      |  | 2950        | 3072 | 3380 | 3534 | 3687 | 4302 | 4609  |
| MCM220HS00 | Profim COM K22HS<br><ul style="list-style-type: none"> <li>• "spider" frame</li> <li>• frame: black</li> <li>• swivel</li> <li>• seat upholstered pad</li> </ul>   |  | 3237        | 3372 | 3680 | 3834 | 3986 | 4602 | 4909  |
| MCM220HC00 | Profim COM K22HC<br><ul style="list-style-type: none"> <li>• "spider" frame</li> <li>• frame: black</li> <li>• on castors</li> <li>• seat upholstered pad</li> </ul>   |  | 3283        | 3420 | 3728 | 3880 | 4035 | 4648 | 4955  |
| MCM320H000 | Profim COM K32H<br><ul style="list-style-type: none"> <li>• 4-legged</li> <li>• frame: black</li> <li>• plywood shell</li> <li>• seat and backrest upholstered pads</li> </ul>                               |  | 2282        | 2377 | 2617 | 2733 | 2854 | 3330 | 3566  |

| Item no    | Base model +  | Price Group<br>(PG)   | Price Group |       |       |       |       |       | Price |
|------------|---|---|-------------|-------|-------|-------|-------|-------|-------|
|            |   |   | 0           | ①     | ②     | ③     | ④     | ⑤     |       |
| MCM320V000 | Profim COM K32V<br><ul style="list-style-type: none"> <li>• cantilever</li> <li>• wire frame</li> <li>• frame: black</li> <li>• stackable</li> <li>• plywood shell</li> <li>• seat and backrest upholstered pads</li> </ul> |    | 2 391       | 2 491 | 2 738 | 2 863 | 2 987 | 3 486 | 3 734 |
| MCM320HF00 | Profim COM K32HF<br><ul style="list-style-type: none"> <li>• "spider" frame</li> <li>• frame: black</li> <li>• plywood shell</li> <li>• seat and backrest upholstered pads</li> </ul>                                       |    | 3 373       | 3 513 | 3 865 | 4 041 | 4 217 | 4 920 | 5 273 |
| MCM320HS00 | Profim COM K32HS<br><ul style="list-style-type: none"> <li>• "spider" frame</li> <li>• frame: black</li> <li>• swivel</li> <li>• seat and backrest upholstered pads</li> </ul>  |    | 3 662       | 3 814 | 4 165 | 4 340 | 4 516 | 5 219 | 5 571 |
| MCM320HC00 | Profim COM K32HC<br><ul style="list-style-type: none"> <li>• "spider" frame</li> <li>• frame: black</li> <li>• on castors</li> <li>• seat and backrest upholstered pads</li> </ul>  |  | 3 706       | 3 860 | 4 212 | 4 388 | 4 565 | 5 266 | 5 619 |
| MCM420H000 | Profim COM K42H<br><ul style="list-style-type: none"> <li>• 4-legged</li> <li>• frame: black</li> <li>• fully upholstered</li> </ul>  |  | 2 048       | 2 133 | 2 347 | 2 456 | 2 563 | 2 987 | 3 201 |
| MCM420V000 | Profim COM K42V<br><ul style="list-style-type: none"> <li>• cantilever</li> <li>• wire frame</li> <li>• frame: black</li> <li>• stackable</li> <li>• fully upholstered</li> </ul>   |  | 2 156       | 2 245 | 2 472 | 2 583 | 2 696 | 3 145 | 3 370 |
| MCM420CV00 | Profim COM K42CV<br><ul style="list-style-type: none"> <li>• barstool</li> <li>• frame: black</li> <li>• fully upholstered</li> </ul>   |  | 2 678       | 2 789 | 3 068 | 3 207 | 3 348 | 3 906 | 4 184 |

| Item no                                | Base model +  | Price Group (PG)  | Price Group |       |       |       |       |       | Price |
|--|---|---|-------------|-------|-------|-------|-------|-------|-------|
|  |   |   | 0           | ①     | ②     | ③     | ④     | ⑤     |       |
| MCM420HF00                             | Profim COM K42HF<br>• "spider" frame<br>• frame: black<br>• fully upholstered   |    | 3 161       | 3 293 | 3 624 | 3 787 | 3 952 | 4 611 | 4 941 |
| MCM420HS00                             | Profim COM K42HS<br>• "spider" frame<br>• frame: black<br>• swivel<br>• fully upholstered   |    | 3 448       | 3 593 | 3 923 | 4 087 | 4 252 | 4 911 | 5 241 |
| MCM420HC00                             | Profim COM K42HC<br>• "spider" frame<br>• frame: black<br>• on castors<br>• fully upholstered   |    | 3 495       | 3 640 | 3 970 | 4 133 | 4 299 | 4 957 | 5 288 |
| MCM000CTH0                             | Profim COM CTH<br>• Trolley for transportation  |  |             |       |       |       |       |       | 2 116 |
| <b>Accessories/Options/Surcharges:</b> |   |   |             |       |       |       |       |       |       |
| 7TFRA018                               | Frame: V1 - cantilever with metal frame (Only for: K12V, K22V, K32V, K42V)  |   |             |       |       |       |       |       | 425   |
| 7TFRA019                               | Frame: V2 - reversed cantilever (Only for: K12V, K22V, K32V, K42V)  |   |             |       |       |       |       |       | 97    |
| 7COPR002                               | Frames colours: MetallicPro, White RAL 9016, Deep Green RAL 6004, Navy Blue RAL 5003, Burgundy RAL 3005, Salvia/Green RAL 6021, Blue RAL 5014, Terracota RAL 3012 (Only for: K12CV, K12H, K12HC, K12HF, K12HS, K12V, K22CV, K22H, K22HC, K22HF, K22HS, K22V, K32H, K32HC, K32HF, K32HS, K32V, K42CV, K42H, K42HC, K42HF, K42HS, K42V) |   |             |       |       |       |       |       | 36    |
| 7COPR003                               | Frames colours: Lightgrey NCS S 2500-N; Grey NCS S 6500-N, Metalsilver, Steelgray (Only for: K12CV, K12H, K12HC, K12HF, K12HS, K12V, K22CV, K22H, K22HC, K22HF, K22HS, K22V, K32H, K32HC, K32HF, K32HS, K32V, K42CV, K42H, K42HC, K42HF, K42HS, K42V)   |   |             |       |       |       |       |       | 218   |
| 7COPR006                               | Frame colour: Gold (Only for: K12HC, K12HF, K12HS, K22HC, K22HF, K22HS, K32HC, K32HF, K32HS, K42HC, K42HF, K42HS)   |   |             |       |       |       |       |       | 522   |
| 7ARMR001                               | Armrests (Only for: K12H, K12V, K22CV, K22H, K22V, K32H, K32V, K42H, K42V)  |   |             |       |       |       |       |       | 524   |
| 7TARM003                               | Plywood pad for armrest (Only for: K12H, K12V, K22H, K22V, K32H, K32V, K42H, K42V)  |   |             |       |       |       |       |       | 231   |
|  | HPL LW01 (white), LW02 (black), LW03 (light gray )LW04 (grey), LW06 (dark blue), LW07 (light burgundy )(grey) (Only for: K12CV, K12H, K12HC, K12HF, K12HS, K12V, K22CV, K22H, K22HC, K22HF, K22HS, K22V, K32H, K32HC, K32HF, K32HS, K32V)   |   |             |       |       |       |       |       | 572   |
|  | Natural veneers Ash (NA), Beech (NB), Oak (NO), Walnut (NW) (Only for: K12CV, K12H, K12HC, K12HF, K12HS, K12V, K22CV, K22H, K22HC, K22HF, K22HS, K22V, K32H, K32HC, K32HF, K32HS, K32V)   |   |             |       |       |       |       |       | 377   |
|  | Natural colored veneers (ash): White (CNA01), Black (CNA02), Dark green (CNA05), Navy blue (CNA06), Burgundy (CNA07) (Only for: K12CV, K12H, K12HC, K12HF, K12HS, K12V, K22CV, K22H, K22HC, K22HF, K22HS, K22V, K32H, K32HC, K32HF, K32HS, K32V)  |   |             |       |       |       |       |       | 377   |

### Accessories/Options/Surcharges:

|          |   |     |
|----------|---|-----|
| 7SEQU001 | Quilting - pad or front side of the seat (Q1) (Only for: K22CV, K22H, K22HC, K22HF, K22HS, K22V, K32H, K32HC, K32HF, K32HS, K32V)   | 377 |
| 7BAQU001 | Quilting - pad or front of the backrest (Q2) (Only for: K32H, K32HC, K32HF, K32HS, K32V)  | 377 |
| 7SHQU004 | Quilting - front side of the shell (Q3) (Only for: K42CV, K42H, K42HC, K42HF, K42HS, K42V)  | 838 |
| 7JIRO001 | Possibility of joining in rows (Only for: K12H, K12V, K22H, K22V, K32H, K32V, K42H, K42V)   | 316 |
| 7TATO002 | Table top 2PB - extra charge: version with armrests (Only for: K12H, K22H, K32H, K42H)  | 802 |
| 7HAND002 | Shell with cut-out (C) in upper part of the backrest, enabling moving the chair (Only for: K12H, K12HC, K12HF, K12HS, K12V, K22H, K22HC, K22HF, K22HS, K22V, K32H, K32HC, K32HF, K32HS, K32V) | 36  |

**0 price group: Evo**

**1 price group: Cura, Tonal, Xtreme**

**2 price group: Select**

**3 price group: Capture, Oceanic, Step, Synergy**

**4 price group: Steelcut 3, Steelcut Trio 3**

**6 price group: Paloma**

Colours of plywood - standard colours of lacquer: H6, H12, H5

Natural veneers -Ash (NA), Beech (NB), Oak (NO), Wallnut (NW)

Coloured natural veneers - White Ash CNA01, Black Ash CNA02, Deep Green Ash CNA05 (RAL 6004), Navy Blue Ash CNA06 RAL 5003, Burgundy Ash CNA07 RAL 3005

HPL - White LW01 (RAL 9016), Light Grey LW03 (NCS S 2500-N), Grey LW04 (RAL 7037), Black LW02 (RAL 9011), Navy Blue LW06 (RAL 5003), Light Burgundy LW07 (RAL 3004)

Glides:

- standard - teflon glides (universal),

- option - felt glides (for hard floors).

When ordering please clearly indicate the chosen option.

Armrest pad: Version V1 - plastic pad, always black.

Version Com K12 / K22 / K32 colour and type of plywood pad is always the same as shell.

Versions Com K4 (fully upholstered) armrest plywood pad finishing:

- Colours of plywood - standard colours of lacquer: H6, H12, H5

- Natural veneers -Ash (NA), Beech (NB), Oak (NO), Wallnut (NW)

- Coloured natural veneers - White Ash CNA01, Black Ash CNA02, Deep Green Ash CNA05 (RAL 6004), Navy Blue Ash CNA06 RAL 5003, Burgundy Ash CNA07 RAL 3005

- HPL - White LW01 (RAL 9016), Light Grey LW03 (NCS S 2500-N), Grey LW04 (RAL 7037), Black LW02 (RAL 9011), Navy Blue LW06 (RAL 5003), Light Burgundy LW07 (RAL 3004)

Please clearly indicate the chosen option.

Armrests:

- 2P - metal, polypropylene pad (set) - does not apply to versions V and V2,

- 2P - metal, plywood pad (set) - does not apply to versions V, V1 and V2.

Quilting - extra charge to all price groups, lead time 30-40 working days.



Frame version: V2



Frame version: V1



# Com

Paul Brooks

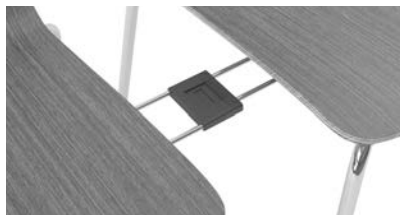

## Joining in rows (H/V)

The linking part is an integral part of the chair, therefore it cannot be purchased and assembled at a later stage. The linking part is suitable for versions: H / H 2P / H 2PB / V.

Linking part is made of stainless steel and black plastic.

The total width of two connected chairs is:

- version H - 1160 mm,
- version H 2P/ H2PB - 1240-1310 mm,
- version V - 1170 mm.



## Joining in rows (V1/V2)

The linking part is suitable for versions: V1 / V1 2P / V2. Always in black.

Total width of two connected chairs:

- version V1 - 985-1075 mm,
- version V1 2P - 1150-1220 mm,
- version V2 - 1165-1245 mm.



## Trolley for transportation (CTH)

Trolley with a handle.

Available colours: black, metallic.

Always with soft castors.

Dimension: 1000 x 1010 x 630 mm



## "Anti-panic" system (APA)\*

"Anti-panic" connectors for chairs without armrests (refers only to the H versions).

Always in black.

Total width of two connected chairs: 1030 mm.



## "Anti-panic" system (APB)\*

"Anti-panic" connectors for chairs with armrests/ armrests with table top (refers only to the H versions).

Always in black.

Total width of two connected chairs: 1220-1290 mm.



## "Anti-panic" system (APD)\*

"Anti-panic" system for connecting rows (refers only to the H versions).

The price is for 1 connector.

Always in black.



## Shell with cut-out (C)

Shell with cut-out in upper part of the backrest, enabling moving the chair. Do not concern versions with shell fully upholstered.



## Table top (2PB)

The table top is an integral part of 2PB models therefore it cannot be purchased separately.







It is assembled on the right side of the chair and is equipped with anti-panic system which prevents blocking the table top in case of sudden movement. It's always black composite.

Maximum table load: 15kg.

# Profim NOOR 4-LEG

StokkeAustad, Form Us With Love, Susanne Grønlund Design and Flokk design team

- Armrests available in matching colours to frame
- Stackable up to 10 chairs, 5 chairs with armrests (upholstered and unupholstered models)
- Table suspension for Profim Noor 6050/55 to Profim Eminent frame table available (See Eminent table)
- Red Dot Design award 2013
- Norwegian Design Council – Award for Design Excellence

| Item no | Base model +  | Price Group (PG)  | Price Group |      |      |      |      |      | Price |      |
|---------|---|---|-------------|------|------|------|------|------|-------|------|
|         |   |   | 0           | ①    | ②    | ③    | ④    | ⑤    |       | ⑥    |
| 6050    | Profim NOOR 6050<br>• Polypropylene chair   |    |             |      |      |      |      |      |       | 1812 |
| 6055    | Profim NOOR 6055<br>• 3D veneer chair<br>• Oak  |    |             |      |      |      |      |      |       | 6200 |
| 6050s   | Profim NOOR 6050S<br>• Polypropylene chair<br>• Seat upholstery   |  | 2027        | 2091 | 2134 | 2241 | 2304 | 2604 | 2946  |      |
| 6050sb  | Profim NOOR 6050sb<br>• Polypropylene chair<br>• Seat + back upholstery   |  | 2338        | 2412 | 2461 | 2584 | 2657 | 3002 | 3397  |      |
| 6050f   | Profim NOOR 6050f<br>• Polypropylene chair<br>• Fully upholstered in selected fabrics.<br>See below Accessories/options for complete list |  | 2765        | 2853 | 2910 | 3055 | 3143 | 3551 |       |      |
| 6055s   | Profim NOOR 6055s<br>• 3D veneer chair<br>• Oak<br>• Seat upholstery  |  | 6194        | 6391 | 6520 | 6847 | 7043 | 7954 | 9001  |      |



| Item no | Base model +   | Price Group (PG)  | Price Group |       |       |       |       |       | Price |
|---------|--|---|-------------|-------|-------|-------|-------|-------|-------|
|         |  |   | 0           | ①     | ②     | ③     | ④     | ⑤     |       |
| 6055sb  | Profim NOOR 6055sb<br>• 3D veneer chair<br>• Oak<br>• Seat + back upholstery |  | 6 507       | 6 710 | 6 848 | 7 190 | 7 363 | 8 355 | 9 451 |

**Accessories/Options/Surcharges:**

|         |  |     |
|---------|--|-----|
| 3YES    | Linking device, welded. Must be specified at time of order. Can not be retrofitted.    | 91  |
| PD303   | Felt glides - 4 units.   | 62  |
| AR809   | Noor armrests pair (Only for: 6055, 6055s, 6055sb)                                     | 843 |
| SH30006 | Additional price* for dark stained oak 3D veneer shell (Only for: 6055, 6055s, 6055sb) | 368 |

**0 price group: Alba, Evo, Next,**

**1 price group: Cura, Tonal, Xtreme**

**2 price group: Select**

**3 price group: Capture, Oceanic, Step, Synergy**

**4 price group: Steelcut 3, Steelcut Trio 3**

6-8 mm polypropylene (PP) and 6.7 mm 3D veneer shells (oak or dark stained oak\*)

16x2 mm 4 leg tubular steel base

Weight: 5.7 kg model 6050, 4.7 kg model 6055

Seat height 439 mm, Back height 357 mm, Chair width 543 mm, Chair width w/armrests 550 mm, Chair height 835 mm, Chair depth 490 mm



S=Standard Collection - normal production time 10-15 working days. Applicable when all component options (fabric, shell, frame/legs) are standard (S).

E=Extended Collection - normal production time 20-30 working days. Applicable when any or all component options selected are extended (E).







For larger orders, please contact Customer Service for delivery details.



# Profim NOOR SLEDGEBASE

StokkeAustad, Form Us With Love, Susanne Grønlund Design and Flokk design team

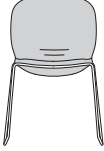
- Armrests available in matching colours to frame
- Stackable up to 10 chairs, 5 chairs with armrests (upholstered and unupholstered models)
- Table suspension for Profim Noor 6060/65 to Profim Eminent frame table available.
- Red Dot Design - 'Best of the best' award winner 2013
- Norwegian Design Council - Award for Design Excellence

| Item no | Base model +  | Price Group (PG)  | Price Group |      |      |      |      |      | Price |      |
|---------|---|---|-------------|------|------|------|------|------|-------|------|
|         |   |   | 0           | ①    | ②    | ③    | ④    | ⑤    |       | ⑥    |
| 6060    | Profim NOOR 6060<br>• Polypropylene chair   |    |             |      |      |      |      |      |       | 2042 |
| 6065    | Profim NOOR 6065<br>• 3D veneer chair<br>• Oak  |   |             |      |      |      |      |      |       | 6427 |
| 6060s   | Profim NOOR 6060s<br>• Polypropylene chair<br>• Seat upholstery   |  | 2242        | 2315 | 2361 | 2479 | 2550 | 2880 | 3261  |      |
| 6060sb  | Profim NOOR 6060sb<br>• Polypropylene chair<br>• Seat + back upholstery   |  | 2554        | 2635 | 2689 | 2823 | 2905 | 3281 | 3710  |      |
| 6060f   | Profim NOOR 6060f<br>• Polypropylene chair<br>• Fully upholstered in selected fabrics.<br>See below Accessories/options for complete list |  | 2983        | 3077 | 3139 | 3293 | 3390 | 3829 |       |      |
| 6065s   | Profim NOOR 6065s<br>• 3D veneer chair<br>• Oak<br>• Seat upholstery  |  | 6413        | 6614 | 6751 | 7086 | 7290 | 8235 | 9315  |      |

| Item no | Base model +   | Price Group (PG)  | Price Group |       |       |       |       |       | Price |
|---------|--|---|-------------|-------|-------|-------|-------|-------|-------|
|         |  |   | 0           | ①     | ②     | ③     | ④     | ⑤     |       |
| 6065sb  | Profim NOOR 6065sb<br>• 3D veneer chair<br>• Oak<br>• Seat + back upholstery |  | 6 723       | 6 934 | 7 076 | 7 429 | 7 641 | 8 633 | 9 766 |

**Accessories/Options/Surcharges:**

|         |  |     |
|---------|--|-----|
| 3YES    | Linking device, welded. Must be specified at time of order. Can not be retrofitted.    | 91  |
| PD303   | Felt glides - 4 units.   | 68  |
| AR809   | Noor armrests pair (Only for: 6065, 6065s, 6065sb)                                     | 843 |
| SH30006 | Additional price* for dark stained oak 3D veneer shell (Only for: 6065, 6065s, 6065sb) | 368 |

**0 price group: Alba, Evo, Next,**

**1 price group: Cura, Tonal, Xtreme**

**2 price group: Select**

**3 price group: Capture, Oceanic, Step, Synergy**

**4 price group: Steelcut 3, Steelcut Trio 3**

6-8 mm polypropylene (PP) and 6.7 mm 3D veneer shells (oak or dark stained oak\*) 12 mm steel sledgebase Weight: 6.5 kg model 6060, 6.2 kg model 6065  
Seat height 439 mm, Back height 357 mm, Chair width 557 mm, Chair height 835 mm, Chair depth 525 mm



S=Standard Collection – normal production time 10-15 working days. Applicable when all component options (fabric, shell, frame/legs) are standard (S).

E=Extended Collection – normal production time 20-30 working days. Applicable when any or all component options selected are extended (E).

For larger orders, please contact Customer Service for delivery details.



# Profim NOOR FOOTBASE

StokkeAustad, Form Us With Love, Susanne Grønlund Design and Flokk design team

- Standard gaslift B black
- Seat mechanism and footbase (Ø665 mm) in black painted aluminium as standard.
- Polished aluminium seat mechanism and footbase available as option. Seat mechanism, gaslift and footbase in white lacquered aluminium available as option
- Armrest available in black, white or metal silver
- Table suspension for Profim Noor 6070/75 to Profim Eminent frame table available.
- Red Dot Design Award 2013
- Norwegian Design Council – Award for Design Excellence

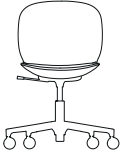
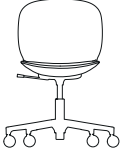
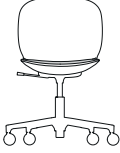
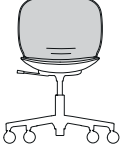
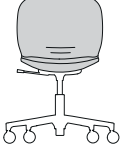
| Item no | Base model +  | Price Group (PG)  | 0     | ①     | ②     | ③     | ④     | ⑤     | ⑥     | Price |
|---------|---|---|-------|-------|-------|-------|-------|-------|-------|-------|
| 6070    | Profim NOOR 6070<br>• Polypropylene chair   |    |       |       |       |       |       |       |       | 2956  |
| 6075    | Profim NOOR 6075<br>• 3D veneer chair<br>• Oak  |   |       |       |       |       |       |       |       | 7343  |
| 6070s   | Profim NOOR 6070s<br>• Polypropylene chair<br>• Seat upholstery   |  | 3 114 | 3 214 | 3 277 | 3 292 | 3 540 | 3 998 | 4 523 |       |
| 6070sb  | Profim NOOR 6070sb<br>• Polypropylene chair<br>• Seat + back upholstery   |  | 3 425 | 3 532 | 3 605 | 3 784 | 3 891 | 4 396 | 4 973 |       |
| 6070f   | Profim NOOR 6070f<br>• Polypropylene chair<br>• Fully upholstered in selected fabrics.<br>See below Accessories/options for complete list |  | 3 850 | 3 971 | 4 053 | 4 254 | 4 379 | 4 944 |       |       |

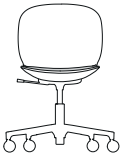
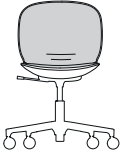
| Item no | Base model +   | Price Group (PG)  | Price Group |       |       |       |       |       | Price  |
|---------|--|---|-------------|-------|-------|-------|-------|-------|--------|
|         |  |   | 0           | ①     | ②     | ③     | ④     | ⑤     |        |
| 6075s   | Profim NOOR 6075s<br>• 3D veneer chair<br>• Oak<br>• Seat upholstery         |  | 7 280       | 7 511 | 7 663 | 8 047 | 8 277 | 9 347 | 10 576 |
| 6075sb  | Profim NOOR 6075sb<br>• 3D veneer chair<br>• Oak<br>• Seat + back upholstery |  | 7 591       | 7 832 | 7 991 | 8 388 | 8 628 | 9 748 | 11 029 |

#### Accessories/Options/Surcharges:

|              |  |     |
|--------------|--|-----|
| 125182       | Glides, 58 mm  | 0   |
| 115000024009 | Footbase in polished aluminium   | 579 |
| AR809        | Noor armrests pair (Only for: 6075, 6075s, 6075sb)                                     | 843 |
| SH30006      | Additional price* for dark stained oak 3D veneer shell (Only for: 6075, 6075s, 6075sb) | 368 |

- 0 price group: Alba, Evo, Next,**  
**1 price group: Cura, Tonal, Xtreme**  
**2 price group: Select**  
**3 price group: Capture, Oceanic, Step, Synergy**  
**4 price group: Steelcut 3, Steelcut Trio 3**

6-8 mm polypropylene (PP) and 6.7 mm 3D veneer shells (oak or dark stained oak\*)  
 Weight: 8.0 kg model 6070, 7.6 kg model 6075  
 Seat height 355-490 mm, back height 357 mm, chair width and depth 665 mm, chair height 727-857 mm



S=Standard Collection - normal production time 10-15 working days. Applicable when all component options (fabric, shell, frame/legs) are standard (S).  
 E=Extended Collection - normal production time 20-30 working days. Applicable when any or all component options selected are extended (E).







For larger orders, please contact Customer Service for delivery details.



# Profim NOOR WOODEN LEGS

StokkeAustad, Form Us With Love, Susanne Grønlund Design and Flokk design team

- Seat frame in black painted aluminium as standard.
- Wooden legs: natural stained ash as standard.
- Not stackable
- Red Dot Design Award 2013
- Norwegian Design Council – Award for Design Excellence

| Item no | Base model +  | Price Group (PG)  | Price Group |      |      |      |       |       | Price |      |
|---------|---|---|-------------|------|------|------|-------|-------|-------|------|
|         |   |   | 0           | ①    | ②    | ③    | ④     | ⑤     |       | ⑥    |
| 6080    | Profim NOOR 6080<br>• Polypropylene chair   |    |             |      |      |      |       |       |       | 4574 |
| 6085    | Profim NOOR 6085<br>• 3D veneer chair<br>• Oak  |    |             |      |      |      |       |       |       | 8963 |
| 6080s   | Profim NOOR 6080s<br>• Polypropylene chair<br>• Seat upholstery   |  | 4651        | 4801 | 4897 | 5143 | 5290  | 5973  | 6757  |      |
| 6080sb  | Profim NOOR 6080sb<br>• Polypropylene chair<br>• Seat + back upholstery   |  | 4965        | 5119 | 5226 | 5484 | 5643  | 6374  | 7209  |      |
| 6080f   | Profim NOOR 6080f<br>• Polypropylene chair<br>• Fully upholstered in selected fabrics.<br>See below Accessories/options for complete list |  | 5392        | 5560 | 5675 | 5959 | 6131  | 6925  |       |      |
| 6085s   | Profim NOOR 6085s<br>• 3D veneer chair<br>• Oak<br>• Seat upholstery  |  | 8821        | 9098 | 9285 | 9749 | 10028 | 11329 | 12812 |      |

| Item no | Base model +   | Price Group (PG)  | Price Group |       |       |        |        |        | Price  |
|---------|--|---|-------------|-------|-------|--------|--------|--------|--------|
|         |  |   | 0           | ①     | ②     | ③      | ④      | ⑤      |        |
| 6085sb  | Profim NOOR 6085sb<br>• 3D veneer chair<br>• Oak<br>• Seat + back upholstery |  | 9 130       | 9 419 | 9 610 | 10 093 | 10 379 | 11 726 | 13 263 |

**Accessories/Options/Surcharges:**

|         |  |     |
|---------|--|-----|
| PD303   | Felt glides - 4 units.   | 68  |
| SH30006 | Additional price* for dark stained oak 3D veneer shell (Only for: 6085, 6085s, 6085sb) | 368 |

**0 price group: Alba, Evo, Next,**

**1 price group: Cura, Tonal, Xtreme**

**2 price group: Select**

**3 price group: Capture, Oceanic, Step, Synergy**

**4 price group: Steelcut 3, Steelcut Trio 3**

6-8 mm polypropylene (PP) and 6.7 mm 3D veneer shells (oak or dark stained oak\*)

Weight: 5.4 kg model 6080, 4.6 kg model 6085

Seat height 439 mm, Back height 357 mm, Chair width 490 mm, Chair height 832 mm, Chair depth 480 mm



S=Standard Collection – normal production time 10-15 working days. Applicable when all component options (fabric, shell, frame/legs) are standard (S).

E=Extended Collection – normal production time 20-30 working days. Applicable when any or all component options selected are extended (E).







For larger orders, please contact Customer Service for delivery details.



# Profim NOOR UP

StokkeAustad, based on the design of the RBM Noor of StokkeAustad, Form Us With Love, Susanne Grønlund Design and Flokk design team

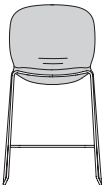
- Suitable for tables around 90 cm high
- Armrests available in matching colours to frame
- Stackable up to 5 chairs

| Item no | Base model +   | Price Group (PG)  | Price Group |      |      |      |      |      | Price |      |
|---------|--|---|-------------|------|------|------|------|------|-------|------|
|         |  |   | 0           | ①    | ②    | ③    | ④    | ⑤    |       | ⑥    |
| 6090    | Profim NOOR UP 6090<br>• Polypropylene chair   |    |             |      |      |      |      |      |       | 2771 |
| 6095    | Profim NOOR UP 6095<br>• 3D veneer chair<br>• Oak  |    |             |      |      |      |      |      |       | 7159 |
| 6090s   | Profim NOOR UP 6090s<br>• Polypropylene chair<br>• Seat upholstery   |  | 2940        | 3033 | 3094 | 3247 | 3340 | 3773 | 4269  |      |
| 6090sb  | Profim NOOR UP 6090sb<br>• Polypropylene chair<br>• Seat + back upholstery   |  | 3249        | 3351 | 3420 | 3591 | 3695 | 4172 | 4718  |      |
| 6090f   | Profim NOOR UP 6090f<br>• Polypropylene chair<br>• Fully upholstered in selected fabrics.<br>See below Accessories/options for complete list |  | 3675        | 3792 | 3869 | 4063 | 4180 | 4719 |       |      |
| 6095s   | Profim NOOR UP 6095s<br>• 3D veneer chair<br>• Oak<br>• Seat upholstery  |  | 7108        | 7334 | 7482 | 7856 | 8079 | 9127 | 10323 |      |



| Item no | Base model +  | Price Group (PG)  | Price Group |       |       |       |       |       | Price  |
|---------|---|---|-------------|-------|-------|-------|-------|-------|--------|
|         |   |   | 0           | ①     | ②     | ③     | ④     | ⑤     |        |
| 6095sb  | Profim NOOR UP 6095sb<br>• 3D veneer chair<br>• Oak<br>• Seat + back upholstery |  | 7 417       | 7 653 | 7 807 | 8 197 | 8 432 | 9 524 | 10 773 |

**Accessories/Options/Surcharges:**

|         |  |     |
|---------|--|-----|
| PD303   | Felt glides - 4 units.   | 68  |
| SH30006 | Additional price* for dark stained oak 3D veneer shell (Only for: 6095, 6095s, 6095sb) | 379 |

**0 price group: Alba, Evo, Next,**

**1 price group: Cura, Tonal, Xtreme**

**2 price group: Select**

**3 price group: Capture, Oceanic, Step, Synergy**

**4 price group: Steelcut 3, Steelcut Trio 3**

6-8 mm polypropylene (PP) and 6.7 mm 3D veneer shells (oak or dark stained oak\*)

Weight: 7.7 kg model 6090, 7.2 kg model 6095

12 mm medium-high steel sledgebase

Seat height 630 mm, Back height 357 mm, Chair width 565 mm, Chair height 1025 mm, Chair depth 548 mm



S=Standard Collection – normal production time 10-15 working days. Applicable when all component options (fabric, shell, frame/legs) are standard (S).

E=Extended Collection – normal production time 20-30 working days. Applicable when any or all component options selected are extended (E).



For larger orders, please contact Customer Service for delivery details.



# Profim NORMO

## Studio Ganszyniec

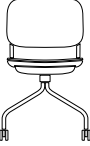
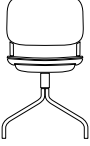
- Chair designed for work and meetings
  - Solid metal construction guarantees stability regardless of intensity of use
  - Our first circular product
  - Manufactured without the use of glue or staples for easy disassembly
  - The seat structure is created from 100% recycled plastic (PP)
  - Normo can be separated/disassembled and recycled up to 94%

| Item no    | Base model +   | Price Group (PG)  | 0     | ①     | ②     | ③     | ④     | ⑤     | ⑥     | Price |
|------------|--|---|-------|-------|-------|-------|-------|-------|-------|-------|
| MKN500H000 | Profim NORMO 500H<br>• 4 legged<br>• seat and backrest upholstered                             |    | 2 540 | 2 820 | 3 233 | 3 367 | 3 755 | 3 755 | 4 327 |       |
| MKN500HC00 | Profim NORMO 500HC<br>• spider' frame on castors<br>• seat and backrest upholstered            |   | 3 512 | 3 792 | 4 205 | 4 363 | 4 728 | 4 874 | 5 627 |       |
| MKN500HS00 | Profim NORMO 500HS<br>• spider' frame on glides<br>• swivel<br>• seat and backrest upholstered |  | 3 780 | 4 047 | 4 461 | 4 643 | 4 971 | 5 190 | 5 968 |       |
| MKN500V000 | Profim NORMO 500V<br>• cantilever<br>• seat and backrest upholstered                           |  | 2 625 | 2 905 | 3 318 | 3 452 | 3 829 | 3 841 | 4 449 |       |

### Accessories/Options/Surcharges:

|          |                            |     |
|----------|----------------------------|-----|
| 7ARMR020 | SP - metal armrests, short | 377 |
| 7ARMR021 | LP - metal armrests, long  | 438 |

**0 price group: Evo**

**1 price group: Cura, Tonal, Xtreme**

**2 price group: Select**

**3 price group: Capture, Oceanic, Step, Synergy**

**4 price group: Steelcut 3, Steelcut Trio 3**

Frames colours:

- Black RAL 9005
- MetallicPro
- White RAL 9016

- Lightgrey NCS S 2500-N
- Grey NCS S 6500-N
- Deep green RAL 6004
- Navy blue RAL 5003
- Burgundy RAL 3005
- Salvia/Green RAL 6021
- Blue RAL 5014
- Terracota RAL 3012

Glides:

- teflon glides (universal),
- felt glides (for hard floors).

Castors in HC model:

- universal.

When ordering please clearly indicate the chosen option.



Armrest SP





Armrest LP



# Profim ZOO

## Paul Brooks

- Variety of configurations
- Available in different versions: on four legs, legs with castors, with plastic or upholstered seat, plastic or upholstered backrest, with or without armrests
- Available in three plastic colours (black, grey and light grey) and five frame colours

| Item no    | Base model +  | Price Group (PG)  | 0     | ①     | ②     | ③     | ④     | ⑤     | Price |
|------------|---|---|-------|-------|-------|-------|-------|-------|-------|
| MZO522H000 | Profim ZOO 522H<br>• 4-legged<br>• frame: black<br>• plastic seat and backrest              |    |       |       |       |       |       |       | 2 139 |
| MZO502H000 | Profim ZOO 502H<br>• 4-legged<br>• frame: black<br>• upholstered seat<br>• plastic backrest |    | 2 406 | 2 625 | 2 795 | 2 905 | 3 428 | 3 233 |       |
| MZO500H000 | Profim ZOO 500H<br>• 4-legged<br>• frame: black<br>• upholstered seat and backrest          |  | 3 464 | 3 902 | 4 363 | 4 545 | 5 384 | 5 069 |       |

### Accessories/Options/Surcharges:

|          |  |     |
|----------|--|-----|
| 7TFRA005 | Frame HC - 4-legged version with castors | 608 |
| 7CFRA051 | Frame: MetallicPro                       | 36  |
| 7ARMR001 | Armrests                                 | 461 |
| 7TATO002 | Table top                                | 838 |
| 7JIRO001 | Possibility of joining in rows           | 329 |

**0 price group: Evo**

**1 price group: Cura, Tonal, Xtreme**

**2 price group: Select**

**3 price group: Capture, Oceanic, Step, Synergy**

**4 price group: Steelcut 3, Steelcut Trio 3**

Glides:

- standard - teflon glides (universal),
- option - felt glides (for hard floors).

Castors in HC models:

- universal castors

When ordering please clearly indicate the chosen option.

Plastic colours for seats, backrests and armrests:

black (RAL 9005), grey (NCS S 6500-N), lightgrey (NCS S 2500-N).

It is possible to freely join the colours of seat, backrest and armrests.

Although in one RAL/NCS, the colour of individual elements of the chair such as seat, backrest, armrests and frame, can vary due to different types of materials used.

Seat cover:

- black frame - cover always black (RAL 9005),
- MetallicPro, RAL/NCS - cover always grey (NCS S 6500-N), except of chairs with black plastic seat - in that case cover is always black (RAL 9005).

In model Zoo 500 without armrests the plastic elements

connecting the frame with backrest are:

- black frame - always black (RAL 9005),
- MetallicPro frame - always grey (NCS S 6500-N),
- grey / lightgrey frame - always in frame colour.



Frame version: HC



# Zoo

Paul Brooks



## Table top (2PB)

The table top is an integral part of 2PB models therefore it cannot be purchased separately. It is assembled on the right side of the chair and is equipped with anti-panic system which prevents blocking the table top in case of sudden movement. It's always black composite. Maximum table load: 15 kg.

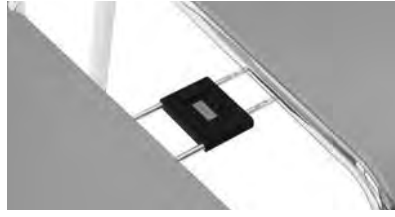

## Joining in rows - 4-legged version

The linking part is an integral part of the chair, therefore it cannot be purchased and assembled at a later stage. The linking part is suitable for versions on 4 legs (H/H 2P/H 2PB). Linking part is made of stainless steel and black plastic. The total width of two connected chairs is:  
- no armrests - 1070 mm,  
- with armrests - 1260 mm.



## „Anti-panic” system (APA)\*

"Anti-panic" connectors for chairs without armrests. Available colours: black, metallic. Total width of two connected chairs: 1120 mm. The anti-panic system meets EN 14703 norm.



## „Anti-panic” system (APB)\*

"Anti-panic" connectors for chairs with armrests. Always in black. Total width of two connected chairs: 1170 mm. The anti-panic system meets EN 14703 norm.



## „Anti-panic” system (APC)\*

"Anti-panic" connectors for chairs with armrests and a table top. Always in black. Total width of two connected chairs: 1350 mm. The anti-panic system meets EN 14703 norm.



## „Anti-panic” system (APD)\*

"Anti-panic" system for connecting rows. The price is for 1 connector. Always in black. The anti-panic system meets EN 14703 norm.



## Trolley for transportation (CTH)

Trolley with a handle. Available colours: black, metallic. Always with soft castors. Dimensions: 1000 x 1000 x 600 mm

Sofas







Armchairs

Modular systems

# Profim CHIC

Christophe Pillet

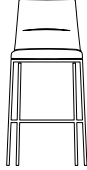
- The seat is equipped with the return memory (it returns to the starting position by itself)
- Restaurant and bar chairs with a range of bases and armchairs with a swivel base or with glides
- Möbelfakta certificate - a guarantee of durability, safety, environmental care and social responsibility during the production process

| Item no    | Base model +   | Price Group (PG)  | Price Group |       |       |       |       |       | Price  |
|------------|--|---|-------------|-------|-------|-------|-------|-------|--------|
|            |  |   | 0           | ①     | ②     | ③     | ④     | ⑤     |        |
| MCC210H000 | Profim CHIC 21H<br><ul style="list-style-type: none"> <li>• chair</li> <li>• metal legs</li> <li>• frame: MetallicPro; Black RAL 9005; White RAL 9016; Deep Green RAL 6004; Navy Blue RAL 5003; Burgundy RAL 3005; Salvia/Green RAL 6021, Blue RAL 5014; Terracota RAL 3012</li> <li>• without armrests</li> </ul> |    | 4 242       | 4 419 | 4 860 | 5 082 | 5 303 | 6 186 | 6 627  |
| MCC200H000 | Profim CHIC 20H<br><ul style="list-style-type: none"> <li>• chair</li> <li>• metal legs</li> <li>• frame: MetallicPro; Black RAL 9005; White RAL 9016; Deep Green RAL 6004; Navy Blue RAL 5003; Burgundy RAL 3005; Salvia/Green RAL 6021, Blue RAL 5014; Terracota RAL 3012</li> <li>• with armrests</li> </ul>    |    | 4 636       | 4 830 | 5 313 | 5 555 | 5 797 | 6 763 | 7 246  |
| MCC200F000 | Profim CHIC 20F<br><ul style="list-style-type: none"> <li>• chair</li> <li>• base: polished aluminium</li> <li>• 4-star base</li> </ul>  |  | 5 337       | 5 560 | 6 116 | 6 395 | 6 673 | 7 785 | 8 340  |
| MCC100FU00 | Profim CHIC 10FU<br><ul style="list-style-type: none"> <li>• armchair</li> </ul>   |  | 6 777       | 7 060 | 7 765 | 8 117 | 8 470 | 9 881 | 10 587 |
| MCC210CH00 | Profim CHIC 21CH<br><ul style="list-style-type: none"> <li>• bar stool without armrests</li> <li>• metal legs</li> <li>• frame: MetallicPro; Black RAL 9005; White RAL 9016; Deep Green RAL 6004; Navy Blue RAL 5003; Burgundy RAL 3005; Salvia/Green RAL 6021, Blue RAL 5014; Terracota RAL 3012</li> </ul>       |  | 4 962       | 5 169 | 5 685 | 5 942 | 6 202 | 7 234 | 7 751  |
| MCC200CH00 | Profim CHIC 20CH<br><ul style="list-style-type: none"> <li>• bar stool</li> <li>• metal legs</li> <li>• frame: MetallicPro; Black RAL 9005; White RAL 9016; Deep Green RAL 6004; Navy Blue RAL 5003; Burgundy RAL 3005; Salvia/Green RAL 6021, Blue RAL 5014; Terracota RAL 3012</li> </ul>                        |  | 5 355       | 5 578 | 6 138 | 6 416 | 6 694 | 7 812 | 8 369  |



**Accessories/Options/Surcharges:**

|          |   |      |
|----------|---|------|
| 7TFRA011 | Frame: HW - wooden legs beech wood - H5, H6, H7, H8, H11, H12 (HW) (Only for: 20H, 21H)                             | 2670 |
| 7TGAS003 | Gas lift with memory (Only for: 20F)  | 802  |
| 7TFRA022 | Gas lift with memory without height adjustment (Only for: 10FU)   | 1957 |
| 7COPR003 | Frames colours: Lightgrey NCS S 2500-N; Grey NCS S 6500-N , Metalsilver, Steelgray (Only for: 20CH, 20H, 21CH, 21H) | 218  |
| 7COPR006 | Frame colour: Gold (Only for: 20H, 21H)   | 425  |

**0 price group: Evo**

**1 price group: Cura, Tonal, Xtreme**

**2 price group: Select**

**3 price group: Capture, Oceanic, Step, Synergy**

**4 price group: Steelcut 3, Steelcut Trio 3**

**6 price group: Paloma**

Glides:

- standard - teflon glides (universal),

- option - felt glides (for hard floors).

When ordering please clearly indicate the chosen option.









Frame version: HW

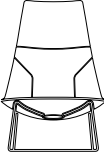

# Profim CHIC LOUNGE

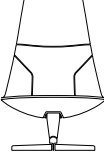
Christophe Pillet

- Characteristic detail in the form of vertical stitching
- Two backrest levels – for different needs and different users
- Possibility to combine leather and fabric in one cover
- Possibility to choose different upholstery colours
- Cushion and footrest increase the comfort of rest
- Attractive price/quality ratio
- Möbelfakta certificate - a guarantee of durability, safety, environmental care and social responsibility during the production process

| Item no    | Base model +  | Price Group (PG)  | ①      | ②      | ③      | ④      | ⑤      | ⑥      | Price |
|------------|---|---|--------|--------|--------|--------|--------|--------|-------|
| MCLA10V300 | Profim CHIC LOUNGE A10V3<br>• armchair<br>• high backrest<br>• wire frame<br>• frame: MetallicPro; Black RAL 9005; White RAL 9016; Deep Green RAL 6004; Navy Blue RAL 5003; Burgundy RAL 3005; Salvia/Green RAL 6021, Blue RAL 5014; Terracota RAL 3012 |    | 8 518  | 9 370  | 9 796  | 10 223 | 11 925 | 16 043 |       |
| MCLA20V300 | Profim CHIC LOUNGE A20V3<br>• armchair<br>• low backrest<br>• wire frame<br>• frame: MetallicPro; Black RAL 9005; White RAL 9016; Deep Green RAL 6004; Navy Blue RAL 5003; Burgundy RAL 3005; Salvia/Green RAL 6021, Blue RAL 5014; Terracota RAL 3012  |   | 7 659  | 8 422  | 8 808  | 9 189  | 10 720 | 13 952 |       |
| MCLA10F000 | Profim CHIC LOUNGE A10F<br>• armchair<br>• high backrest<br>• 4-star base<br>• frame: MetallicPro; Black RAL 9005; White RAL 9016; Deep Green RAL 6004; Navy Blue RAL 5003; Burgundy RAL 3005; Salvia/Green RAL 6021, Blue RAL 5014; Terracota RAL 3012 |  | 10 990 | 12 087 | 12 640 | 13 188 | 15 387 | 18 985 |       |
| MCLA20F000 | Profim CHIC LOUNGE A20F<br>• armchair<br>• low backrest<br>• 4-star base<br>• frame: MetallicPro; Black RAL 9005; White RAL 9016; Deep Green RAL 6004; Navy Blue RAL 5003; Burgundy RAL 3005; Salvia/Green RAL 6021, Blue RAL 5014; Terracota RAL 3012  |  | 10 129 | 11 142 | 11 646 | 12 154 | 14 180 | 16 833 |       |
| MCLPV30000 | Profim CHIC LOUNGE PV3<br>• footrest<br>• wire frame<br>• frame: MetallicPro; Black RAL 9005; White RAL 9016; Deep Green RAL 6004; Navy Blue RAL 5003; Burgundy RAL 3005; Salvia/Green RAL 6021, Blue RAL 5014; Terracota RAL 3012                      |  | 4 661  | 5 127  | 5 362  | 5 594  | 6 526  | 8 350  |       |
| MCLCU00000 | Profim CHIC LOUNGE CU<br>• high backrest cushion  |  | 786    | 866    | 903    | 943    | 1 102  | 1 750  |       |

---

**Accessories/Options/Surcharges:**

---

|          |  |     |
|----------|--|-----|
| 7COPR003 | Frames colours: Lightgrey NCS S 2500-N; Grey NCS S 6500-N , Metalsilver, Steelgray (Only for: A10F, A10V3, A20F, A20V3, PV3) | 218 |
| 7COPR006 | Frame colour: Gold (Only for: A10F, A20F)  | 742 |
| 7COPR006 | Frame colour: Gold (Only for: A10V3, A20V3, PV3)   | 522 |

---

**1 price group: Cura, Tonal, Xtreme**

**2 price group: Select**

**3 price group: Capture, Oceanic, Step, Synergy**

**4 price group: Steelcut 3, Steelcut Trio 3**

**6 price group: Paloma**

Glides:

- standard - teflon glides (universal),
- option - felt glides (for hard floors).

When ordering please clearly indicate the chosen option.

Option of mixing colours of the same fabric according to below scheme:

A - inner part of shell colour, B - outer part of shell colour.

In case of order of such option, following example should be specified: SC-67097/SC-60132 (where SC-67097 - A, SC-60132 - B).

Option is available at no extra charge.





In models A10V3/A10F it is possible to order extra cushion for the backrest.



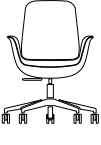

# Profim ELLIE PRO

## ITO Design

- Quick and easy adjustment with the synchro self mechanism (height and tilt adjustment).
- Mechanism fully integrated into the seat
- Possibility of choosing two-colour upholstery
- Several types and colours of bases (four- and five-star bases and metal wire frame or version with wooden legs)
- Blue Angel certificate - confirms that our chair is environmentally friendly

| Item no    | Base model +  | Price Group (PG)  | 0     | ①     | ②     | ③     | ④      | ⑤      | Price |
|------------|---|---|-------|-------|-------|-------|--------|--------|-------|
| MHB100ST00 | Profim ELLIE PRO 10ST<br><ul style="list-style-type: none"> <li>• swivel armchair</li> <li>• Self mechanism</li> <li>• high backrest</li> <li>• 5-star base</li> <li>• base: black</li> </ul>   |    | 7 410 | 7 719 | 8 490 | 8 876 | 9 263  | 10 805 |       |
| MHB200ST00 | Profim ELLIE PRO 20ST<br>swivel armchair<br>Self mechanism<br>low backrest<br>5-star base<br>base: black  |    | 7 121 | 7 418 | 8 160 | 8 530 | 8 901  | 10 163 |       |
| MHB100HS00 | Profim ELLIE PRO 10HST<br><ul style="list-style-type: none"> <li>• swivel armchair</li> <li>• Self mechanism</li> <li>• high backrest</li> <li>• high 4-star base</li> <li>• base: black / MetallicPro / white / polished aluminum</li> </ul> |  | 7 963 | 8 295 | 9 123 | 9 537 | 9 952  | 11 611 |       |
| MHB200HS00 | Profim ELLIE PRO 20 HST<br><ul style="list-style-type: none"> <li>• swivel armchair</li> <li>• Self mechanism</li> <li>• low backrest</li> <li>• high 4-star base</li> <li>• base: black / MetallicPro / white / polished aluminum</li> </ul> |  | 7 675 | 7 994 | 8 793 | 9 194 | 9 591  | 11 192 |       |
| MHB100V000 | Profim ELLIE PRO 10V3<br><ul style="list-style-type: none"> <li>• swivel armchair</li> <li>• Self mechanism</li> <li>• high backrest</li> <li>• wire frame</li> <li>• frame: black / MetallicPro / white</li> </ul>                           |  | 8 339 | 8 686 | 9 556 | 9 991 | 10 424 | 12 161 |       |
| MHB200V000 | Profim ELLIE PRO 20V3<br><ul style="list-style-type: none"> <li>• swivel armchair</li> <li>• Self mechanism</li> <li>• low backrest</li> <li>• wire frame</li> <li>• frame: black / MetallicPro / white</li> </ul>                            |  | 8 052 | 8 387 | 9 227 | 9 644 | 10 065 | 11 743 |       |

| Item no    | Base model +  | Price Group (PG)  | 0      | ①      | ②      | ③      | ④      | ⑤      | Price |
|------------|---|---|--------|--------|--------|--------|--------|--------|-------|
| MHB100HW00 | Profim ELLIE PRO 10HW<br>• swivel armchair<br>• Self mechanism<br>• high backrest<br>• wooden legs<br>• frame: beech wood - H5, H6, H12 |  | 10 586 | 11 027 | 12 130 | 12 681 | 13 232 | 15 437 |       |

|            |  |   |        |        |        |        |        |        |  |
|------------|--|---|--------|--------|--------|--------|--------|--------|--|
| MHB200HW00 | Profim ELLIE PRO 20HW<br>• swivel armchair<br>• Self mechanism<br>• low backrest<br>• wooden legs<br>• frame: beech wood - H5, H6, H12 |  | 10 299 | 10 728 | 11 800 | 12 337 | 12 872 | 15 017 |  |
|------------|--|---|--------|--------|--------|--------|--------|--------|--|

#### Accessories/Options/Surcharges:

|          |  |     |
|----------|--|-----|
| 7BASC008 | Light Gray (Only for: 10ST, 20ST)  | 109 |
| 7TARM006 | Upholstered armpad - leather pad on the armrests                                 | 218 |
| 7COPR003 | Frames colours: Lightgrey NCS S 2500-N; Grey NCS S 6500-N (Only for: 10V3, 20V3) | 218 |
| 7CFRA025 | Frame : metalsilver (Only for: 10V3, 20V3)                                       | 243 |
| 7COPR006 | Frame colour: Gold (Only for: 10V3, 20V3)  | 717 |

**0 price group: Evo**

**1 price group: Cura, Tonal, Xtreme**

**2 price group: Select**

**3 price group: Capture, Oceanic, Step, Synergy**

**4 price group: Steelcut 3, Steelcut Trio 3**

Castors / glides:

Standard:

- hard castors - for soft floors.

Option:

- soft castors - for hard floors,

- teflon glides - universal,

- felt glides - for hard floors.

When ordering please clearly indicate the chosen option.

In case of armrests with a leather pad, the threads will always be the same as the upholstery inside the shell.

In models HST, V3, HW Self mechanism is not height adjustable.

Option of mixing colours of the same fabric according to below scheme:

A - inner part of shell colour, B - outer part of shell colour.







In case of order of such option, following example should be specified: SC-67097/SC-60132 (where SC-67097 - A, SC-60132 - B). Option is available at no extra charge.



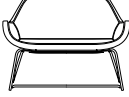

# Profim FAN

Piotr Kuchciński

- Several types of bases - glides and castors as well as wooden legs which perfectly match the SW40 and Revo tables
- Additional cushion improves comfort of use
- The collection also includes a cantilever sofa
- Two types of thread to choose from (upholstery colour or decorative thread)
- Möbelfakta certificate - a guarantee of durability, safety, environmental care and social responsibility during the production process

| Item no    | Base model +   | Price Group (PG)  | Price Group |       |       |       |        |       | Price  |
|------------|--|---|-------------|-------|-------|-------|--------|-------|--------|
|            |  |   | 0           | ①     | ②     | ③     | ④      | ⑤     |        |
| MFN100H000 | Profim FAN 10H<br>• armchair<br>• 4-legged<br>• frame: black   |    | 3 829       | 3 988 | 4 586 | 4 984 | 5 384  | 5 981 | 6 380  |
| MFN100V000 | Profim FAN 10V<br>• armchair<br>• cantilever<br>• frame: black   |    | 4 080       | 4 250 | 4 889 | 5 312 | 5 737  | 6 376 | 6 799  |
| MFN200V000 | Profim FAN 20V<br>• 2-seat sofa<br>• cantilever<br>• frame: black  |  | 6 150       | 7 122 | 8 472 | 8 812 | 11 303 | 9 832 | 13 345 |
| MFN100R000 | Profim FAN 10R<br>• swivel armchair<br>• round base<br>• Gas lift with memory<br>• base: MetallicPro, Black RAL 9005, White RAL 9016, Deep Green RAL 6004, Navy Blue RAL 5003, Burgundy RAL 3005, Salvia/Green RAL 6021, Blue RAL 5014, Terracota RAL 3012 |  | 5 591       | 6 272 | 6 892 | 7 171 | 8 569  | 8 058 | 10 075 |
| MFN100F000 | Profim FAN 10F<br>• swivel armchair<br>• 4-star base<br>• base: polished aluminum  |  | 6 102       | 6 733 | 7 353 | 7 645 | 9 030  | 8 569 | 10 538 |
| MFN100Z000 | Profim FAN 10Z<br>• swivel armchair<br>• Rocker mechanism<br>• base: black   |  | 4 509       | 5 141 | 5 761 | 5 992 | 7 353  | 6 892 | 8 824  |

| Item no    | Base model +   | Price Group (PG)  | Price Group |       |       |       |       |       | Price |
|------------|--|---|-------------|-------|-------|-------|-------|-------|-------|
|            |  |   | 0           | ①     | ②     | ③     | ④     | ⑤     |       |
| MFN100E000 | Profim FAN 10E<br>swivel armchair<br>Economic mechanism<br>base: black |  | 4 072       | 4 704 | 5 335 | 5 542 | 6 940 | 6 466 | 8 422 |

|            |  |   |     |     |     |     |       |       |       |
|------------|--|---|-----|-----|-----|-----|-------|-------|-------|
| MFN1000000 | Profim FAN CU<br>• seat cushion for FAN 10 version |  | 556 | 580 | 674 | 956 | 1 162 | 1 236 | 1 310 |
|------------|--|---|-----|-----|-----|-----|-------|-------|-------|

#### Accessories/Options/Surcharges:

|          |  |       |
|----------|--|-------|
| 7TFRA010 | Frame: HS - swivel version on glides (Only for: 10H)   | 374   |
| 7TFRA009 | Frame: HC - version with castors (Only for: 10H)   | 447   |
| 7TFRA011 | Frame: HW - wooden legs - beech wood: H5, H6, H12 (Only for: 10H)  | 1 661 |
| 7COPR002 | Frames colours: MetallicPro, White RAL 9016, Deep Green RAL 6004, Navy Blue RAL 5003, Burgundy RAL 3005, Salvia/Green RAL 6021, Blue RAL 5014, Terracota RAL 3012 (Only for: 10H, 10V) | 36    |
| 7COPR002 | Frames colours: MetallicPro, White RAL 9016, Deep Green RAL 6004, Navy Blue RAL 5003, Burgundy RAL 3005, Salvia/Green RAL 6021, Blue RAL 5014, Terracota RAL 3012 (Only for: 20V)      | 61    |
| 7COPR006 | Frame colour: Gold (Only for: 10H, 10V)  | 522   |
| 7COPR006 | Frame colour: Gold (Only for: 20V)   | 1 033 |
| 7COPR003 | Frames colours: Lightgrey NCS S 2500-N; Grey NCS S 6500-N, Metalsilver, Steelgray (Only for: 10H, 10R, 10V, 20V)   | 218   |
| 7BASC027 | Base: MetallicPro (Only for: 10E, 10Z)   | 377   |
| 7BASC003 | Base: polished aluminum (Only for: 10Z, 10E)   | 802   |
| 7CPLY010 | Oak wood - HO6, HO12, HO11 (Only for: 10H)   | 329   |
| 7TGAS003 | Gas lift with memory (Only for: 10F)   | 838   |

**0 price group: Evo**

**1 price group: Cura, Tonal, Xtreme**

**2 price group: Select**

**3 price group: Capture, Oceanic, Step, Synergy**

**4 price group: Steelcut 3, Steelcut Trio 3**

**6 price group: Paloma**

Castors / glides

Standard:

- universal castors (models 10Z/10E/10HC),
- teflon glides – universal (models 10F/10H/10HS/10HW),
- hard glides - for soft floors (models 10V/20V).

Option:

- teflon glides – universal (10Z/10E),
- felt glides - for hard floors (10H/10HS/10HW/10V/20V/10F),
- felt pads under the base - for hard floors (model 10R).

When ordering please clearly indicate the chosen option.

Model 10HW: wooden legs: beech wood - H5, H6, H12,

Two options of threads:

- upholstery matching threads
  - decorative threads:
    - black upholstery - threads always white,
    - all other colours of upholstery - threads always black.
- Option is available at no extra charge.



Frame version: 10HC



Frame version: 10HW









# Profim NU

## Paul Brooks

- The inner and outer sections of the shell may have different coloured fabrics
- The shell is mounted on several types of bases
- The cushion will increase the comfort of rest
- Möbelfakta certificate - a guarantee of durability, safety, environmental care and social responsibility during the production process

| Item no    | Base model +  | Price Group (PG)  | Price Group |       |       |       |        |        | Price  |
|------------|---|---|-------------|-------|-------|-------|--------|--------|--------|
|            |   |   | 0           | ①     | ②     | ③     | ④      | ⑤      |        |
| MNU200H000 | Profim NU 20H<br>• armchair<br>• swivel<br>• 4-legged<br>• frame: black   |    | 4 962       | 5 169 | 5 685 | 5 942 | 6 202  | 7 234  | 11 863 |
| MNU200V000 | Profim NU 20V3<br>• armchair<br>• wire frame<br>• frame: black  |    | 4 854       | 5 056 | 5 560 | 5 812 | 6 067  | 7 077  | 11 619 |
| MNU200R000 | Profim NU 20R<br>• swivel armchair<br>• round base<br>• base: MetallicPro, White RAL 9016, Deep Green RAL 6004, Navy Blue RAL 5003, Burgundy RAL 3005, Salvia/Green RAL 6021, Blue RAL 5014, Terracota RAL 3012 |  | 7 001       | 7 632 | 8 350 | 8 678 | 10 878 | 12 615 | 14 451 |
| MNU200F000 | Profim NU 20F<br>• swivel armchair<br>• 4-star base<br>• base: polished aluminum  |  | 6 507       | 6 777 | 7 455 | 7 794 | 8 132  | 9 488  | 15 193 |

### Accessories/Options/Surcharges:

|          |   |       |
|----------|---|-------|
| 7TFRA009 | Frame: HC - version with castors - white / graphite / polished aluminum (Only for: 20H)   | 624   |
| 7TFRA011 | Frame: HW - wooden legs - beech wood: H5, H6, H7, H8, H11, H12, H13 (Only for: 20H)   | 1 141 |
| 7COPR002 | Frames colours: MetallicPro, White RAL 9016, Deep Green RAL 6004, Navy Blue RAL 5003, Burgundy RAL 3005, Salvia/Green RAL 6021, Blue RAL 5014, Terracota RAL 3012 (Only for: 20H, 20V3) | 48    |
| 7COPR003 | Frames colours: Lightgrey NCS S 2500-N; Grey NCS S 6500-N, Metalsilver, Steelgray (Only for: 20H, 20R, 20V3)  | 218   |
| 7COPR006 | Frame colour: Gold (Only for: 20H, 20V3)  | 522   |
| 7SHQU006 | Quilting - front side of the seat (Q5)  | 499   |
| 7TGAS003 | Gas lift with memory (Only for: 20F, 20R)   | 838   |

0 price group: Evo

1 price group: Cura, Tonal, Xtreme

2 price group: Select

**3 price group: Capture, Oceanic, Step, Synergy**

**4 price group: Steelcut 3, Steelcut Trio 3**

Glides

Standard:

- teflon glides – universal (models 20HS/20HW/20V3/20F).

Option:

- hard castors - for soft floors (model 20H/20HC),

- soft castors - for hard floors (model 20H/20HC),

- teflon glides – universal (models 20H/20HS, 20HW),

- felt glides - for hard floors

When ordering please clearly indicate the chosen option.

Model 20HW: wooden legs: beech wood - H5, H6, H12.

Option of mixing colours of the same fabric according to below scheme:

A - cushion, B - inner part of the shell, C - outer part of the shell.

In case of order of such option, following example should be specified: SC-67097/SC-60132/SC-60999 (where SC-67097 - A, SC-60132 - B, SC-60999 - C).

Option is available at no extra charge.

Quilting - extra charge to all price groups, lead time 30-40 working days.



Frame version: 20HC



Frame version: 20HW







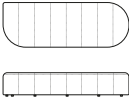

# Profim REVO

Pearson Lloyd

- Represents a radical rethinking of the way office furniture is made.
- Created from recycled and infinitely recyclable REPP, instead of plywood
- Includes sofas, benches, screens, stools and tables in softly contoured, organic shapes
- With 96 configurations can be customised to suit every workspace, whatever its function or size
- The weight of the product is reduced by 40% lowering the carbon footprint during production and transportation by 13% and 40% respectively.
- Manufactured without the use of glue or staples for easy disassembly

| Item no    | Base model +   | Price Group (PG)   | Price Group |        |        |        |        |        | Price  |
|------------|--|--|-------------|--------|--------|--------|--------|--------|--------|
|            |  |  | 0           | ①      | ②      | ③      | ④      | ⑤      |        |
| MRVP400000 | Profim REVO P40<br>• Pouffe,<br>• Ø 40 cm              | <br>     | 5 000       | 5 208  | 5 734  | 6 020  | 6 261  | 7 325  | 9 920  |
| MRVP600000 | Profim REVO P60<br>• Pouffe,<br>• Ø 60 cm              | <br>    | 6 053       | 6 306  | 7 084  | 7 439  | 7 736  | 9 051  | 14 050 |
| MRVSN15000 | Profim REVO SN150<br>• Seat narrow,<br>• lenght 150 cm | <br> | 11 767      | 12 257 | 13 150 | 13 807 | 14 359 | 16 800 | 22 750 |
| MRVSN21000 | Profim REVO SN210<br>• Seat narrow,<br>• lenght 210 cm | <br> | 15 063      | 15 690 | 16 881 | 17 724 | 18 434 | 21 567 | 33 484 |
| MRVSW12000 | Profim REVO SW120<br>• Seat wide,<br>• lenght 120 cm   | <br> | 12 459      | 12 978 | 13 847 | 14 541 | 15 121 | 17 692 | 23 956 |
| MRVSW18000 | Profim REVO SW180<br>• Seat wide,<br>• lenght 180 cm   | <br> | 16 590      | 17 281 | 18 426 | 19 346 | 20 121 | 23 542 | 31 876 |

| Item no    | Base model +   | Price Group (PG)  | Price Group |        |        |        |        |        | Price  |
|------------|--|---|-------------|--------|--------|--------|--------|--------|--------|
|            |  |   | 0           | ①      | ②      | ③      | ④      | ⑤      |        |
| MRVSW24000 | Profim REVO SW240<br>• Seat wide,<br>• lenght 240 cm |    | 20 589      | 21 447 | 22 866 | 24 009 | 24 969 | 29 215 | 39 558 |
| MRVB900000 | Profim REVO B90<br>• Backrest,<br>• lenght 90 cm     |    | 4 483       | 4 669  | 5 092  | 5 348  | 5 561  | 6 507  | 8 810  |
| MRVB120000 | Profim REVO B120<br>• Backrest,<br>• lenght 120 cm   |    | 5 361       | 5 585  | 6 100  | 6 405  | 6 661  | 7 793  | 10 552 |
| MRVB180000 | Profim REVO B180<br>• Backrest,<br>• lenght 180 cm   |  | 7 614       | 7 931  | 8 686  | 9 121  | 9 485  | 11 098 | 15 027 |
| MRVW900000 | Profim REVO W90<br>• Screen,<br>• wide 90 cm         |  | 6 460       | 6 729  | 7 702  | 8 088  | 8 411  | 9 841  | 13 325 |
| MRVW120000 | Profim REVO W120<br>• Screen,<br>• wide 120 cm       |  | 8 196       | 8 538  | 9 830  | 10 323 | 10 736 | 12 560 | 17 006 |
| MRVW180000 | Profim REVO W180<br>• Screen,<br>• wide 180 cm       |  | 10 964      | 11 422 | 13 401 | 14 015 | 14 625 | 17 063 | 23 184 |

### Accessories/Options/Surcharges:

|          |   |       |
|----------|---|-------|
| 7ELEC004 | Mediaport - electrical outlet 230V and 2 USB ports (Only for: P60, SN150, SN210, SW120, SW180, SW240) | 2 735 |
| 7TFOA003 | Flame retardant foam BS 5852 (Only for: B120, B180, B90, P40, P60, SN150, SN210, SW120, SW180, SW240) | 831   |

**0 price group: Evo**

**1 price group: Cura, Tonal, Xtreme**

**2 price group: Select**

**3 price group: Capture, Oceanic, Step, Synergy**

**4 price group: Steelcut 3, Steelcut Trio 3**

For Valencia and Silvertex (extended) fabrics - no quilting on the seat modules

Individual modules allow to create various types of systems / sets depending on your needs. A full list of possible configurations is available through the configurator on the website [www.proffim.eu](http://www.proffim.eu) or directly at the link: [CONFIGURATOR pCon](#).

The price for a configured set is the amount of the value of each module of a given set.

Possibility to freely choose the type of upholstery for individual elements within a given set (e.g. seat: Select, backrest: Synergy, screen: Sprint).

The screens can only be combined with wide seats: SW120, SW160 or SW240.

It is not possible to purchase the screen as a free-standing module.



# Profim SORRISO

Jarosław Szymański, Studio 1:1

- Three base options: cantilever, four-star base or flat base
- Möbelfakta certificate - a guarantee of durability, safety, environmental care and social responsibility during the production process

| Item no    | Base model +   | Price Group (PG)  | Price Group |       |       |       |       |       | Price  |
|------------|--|---|-------------|-------|-------|-------|-------|-------|--------|
|            |  |   | 0           | ①     | ②     | ③     | ④     | ⑤     |        |
| MSY100V000 | Profim SORRISO 10V<br>• armchair<br>• wire frame<br>• frame: black |  | 5 494       | 6 089 | 7 171 | 7 450 | 9 736 | 8 872 | 11 729 |

### Accessories/Options/Surcharges:

|          |  |     |
|----------|--|-----|
| 7SHQU006 | Quilting - front side of the seat (Q5) | 511 |
| 7CFRA051 | Frame: MetallicPro                     | 36  |

**0 price group: Evo**

**1 price group: Cura, Tonal, Xtreme**

**2 price group: Select**

**3 price group: Capture, Oceanic, Step, Synergy**

**4 price group: Steelcut 3, Steelcut Trio 3**

**6 price group: Paloma**

Castors / glides

Standard:

- teflon glides - universal

Option:

- felt glides - for hard floors

When ordering please clearly indicate the chosen option.

Option of mixing colours of the same fabric on shell and cushion according to below scheme:

A - cushion colour, B - shell colour.





In case of order of such option, following example should be specified: SC-67097/SC-60132 (where SC-67097 - A, SC-60132 - B). Option is available at no extra charge.



Quilting - extra charge to all price groups, lead time 30-40 working days.

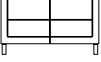
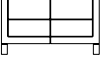

# Profim VANCOUVER LITE

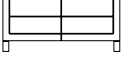
- Armchairs and sofas (in three sizes) come on metal cantilever and metal or wooden legs
- Complementary elements include a TV mount and media ports
- The collection is complemented by a simple wall which is used to connect the set in the shape of the letter "U"

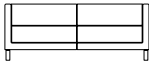
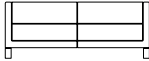
| Item no    | Base model +  | Price Group (PG)  | Price Group |       |        |        |        |        | Price  |
|------------|---|---|-------------|-------|--------|--------|--------|--------|--------|
|            |   |   | 0           | ①     | ②      | ③      | ④      | ⑤      |        |
| MVT100H000 | Profim VANCOUVER LITE VL1 H<br>• armchair<br>• legs<br>• frame: black / MetallicPro / wooden legs       |    | 6 074       | 6 327 | 6 961  | 7 278  | 7 593  | 8 859  | 9 494  |
| MVT100V000 | Profim VANCOUVER LITE VL1 V<br>• armchair<br>• cantilevers<br>• frame: black / MetallicPro              |    | 6 596       | 6 871 | 7 557  | 7 901  | 8 244  | 9 619  | 10 305 |
| MVT200H000 | Profim VANCOUVER LITE VL2 H<br>• 2-seat sofa<br>• legs<br>• frame: black / MetallicPro / wooden legs    |  | 7 567       | 7 883 | 8 670  | 11 206 | 15 046 | 11 035 | 11 822 |
| MVT200V000 | Profim VANCOUVER LITE VL2 V<br>• 2-seat sofa<br>• cantilevers<br>• frame: black / MetallicPro           |  | 8 089       | 8 425 | 9 267  | 9 688  | 10 109 | 11 795 | 12 638 |
| MVT250H000 | Profim VANCOUVER LITE VL2,5H<br>• 2,5-seat sofa<br>• legs<br>• frame: black / MetallicPro / wooden legs |  | 8 518       | 8 873 | 9 760  | 10 205 | 10 648 | 12 423 | 13 311 |
| MVT250V000 | Profim VANCOUVER LITE VL2,5V<br>• 2,5-seat sofa<br>• cantilevers<br>• frame: black / MetallicPro        |  | 8 969       | 9 417 | 10 359 | 10 830 | 11 299 | 13 184 | 14 125 |

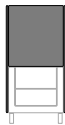
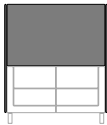
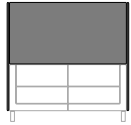
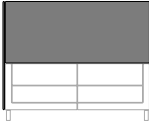
| Item no    | Base model +   | Price Group<br>(PG)   | Price Group |        |        |        |        |        | Price  |
|------------|--|---|-------------|--------|--------|--------|--------|--------|--------|
|            |  |   | 0           | ①      | ②      | ③      | ④      | ⑤      |        |
| MVT300H000 | Profim VANCOUVER LITE VL3 H<br>• 3-seat sofa<br>• legs<br>• frame: black / MetallicPro / wooden legs |    | 10 452      | 12 847 | 15 266 | 12 681 | 13 231 | 15 437 | 16 541 |
| MVT300V000 | Profim VANCOUVER LITE VL3 V<br>• 3-seat sofa<br>• cantilevers<br>• frame: black / MetallicPro        |    | 11 108      | 11 570 | 12 728 | 13 307 | 13 883 | 16 199 | 17 354 |
| MVTSW00000 | Profim VANCOUVER LITE VL SW<br>• straight connecting wall  |    | 2 175       | 2 266  | 2 493  | 2 605  | 2 718  | 3 170  |        |
| MVTW100000 | Profim VANCOUVER LITE VL W1<br>• set of partition walls to be connected with armchair                |  | 7 044       | 7 338  | 8 073  | 8 440  | 8 808  | 10 274 |        |
| MVTW200000 | Profim VANCOUVER LITE VL W2<br>• set of partition walls to be connected with 2-seater sofa           |  | 7 997       | 8 331  | 9 166  | 9 582  | 9 996  | 11 664 |        |
| MVTW250000 | Profim VANCOUVER LITE VL W2,5<br>• set of partition walls to be connected with 2,5-seater sofa       |  | 9 113       | 9 494  | 10 440 | 10 917 | 11 391 | 13 288 |        |
| MVTW300000 | Profim VANCOUVER LITE VL W3<br>• set of partition walls to be connected with 3-seater sofa           |  | 11 359      | 11 833 | 13 014 | 13 607 | 14 199 | 16 564 |        |



**Accessories/Options/Surcharges:**

|          |   |       |
|----------|---|-------|
| 7TFRA013 | Connecting with walls (HW/VW) (Only for: VL1 H, VL1 V)  | 438   |
| 7TFRA013 | Connecting with walls (HW/VW) (Only for: VL2 H, VL2 V)  | 765   |
| 7TFRA013 | Connecting with walls (HW/VW) (Only for: VL2,5H, VL2,5V, VL3 H, VL3 V)  | 1021  |
| 7QUEL004 | Quilting - inner surface (Q6) (Only for: VL SW)   | 2625  |
| 7QUEL004 | Quilting - inner surface (Q6) (Only for: VL W1)   | 3014  |
| 7QUEL004 | Quilting - inner surface (Q6) (Only for: VL W2)   | 4181  |
| 7QUEL004 | Quilting - inner surface (Q6) (Only for: VL W2,5)   | 4765  |
| 7QUEL004 | Quilting - inner surface (Q6) (Only for: VL W3)   | 10696 |
| 7QUEL006 | Quilting - outer surface (Q7) (Only for: VL1 H, VL1 V)  | 1264  |
| 7QUEL006 | Quilting - outer surface (Q7) (Only for: VL2 H, VL2 V)  | 1653  |
| 7QUEL006 | Quilting - outer surface (Q7) (Only for: VL2,5H, VL2,5V)  | 1835  |
| 7QUEL006 | Quilting - outer surface (Q7) (Only for: VL3 H, VL3 V)  | 2334  |
| 7QUEL006 | Quilting - outer surface (Q7) (Only for: VL SW)   | 3099  |
| 7QUEL006 | Quilting - outer surface (Q7) (Only for: VL W1)   | 3707  |
| 7QUEL006 | Quilting - outer surface (Q7) (Only for: VL W2)   | 5069  |
| 7QUEL006 | Quilting - outer surface (Q7) (Only for: VL W2,5)   | 5627  |
| 7QUEL006 | Quilting - outer surface (Q7) (Only for: VL W3)   | 13030 |
| 7TFRA016 | TV handle (SW HA) (Only for: VL SW)   | 2079  |
| 7ELEC004 | Mediaport - electrical outlet 230V and 2 USB ports (Only for: VL1 H, VL1 V, VL2 H, VL2 V, VL2,5H, VL2,5V, VL3 H, VL3 V) | 2735  |

**0 price group: Evo**

**1 price group: Cura, Tonal, Xtreme**

**2 price group: Select**

**3 price group: Capture, Oceanic, Step, Synergy**

**4 price group: Steelcut 3, Steelcut Trio 3**

**6 price group: Paloma**

Glides

Standard:

- hard glides - for soft floors (models H)

- felt pads - for hard floors (models V)

Option:

- felt glides - for hard floors (models H)

When ordering please clearly indicate the chosen option.

Wooden legs: beech wood - H5, H6, H12.

In VL W1, VL W2, VL W2,5, VL W3 option of mixing colours of the same fabric on inner and outer part of the partition wall according to below scheme:

A - inner part of shell, B - outer part of shell.

In case of order of such option, following example should be specified: SC-67097/SC-60132 (gdzie SC-67097 - A, SC-60132 - B). Option is available at no extra charge.

While ordering set of "U-shape" armchairs/sofas (including wall VL SW) please indicate clearly this option on your order. Distance between the seats in "U-shape set" - 940 mm.

Quilting - extra charge to all price groups, lead time 30-40 working days.

SW HA - acceptable dimension of TV: max. diagonal of the screen - 40 inches, max. weight - 10 kg.



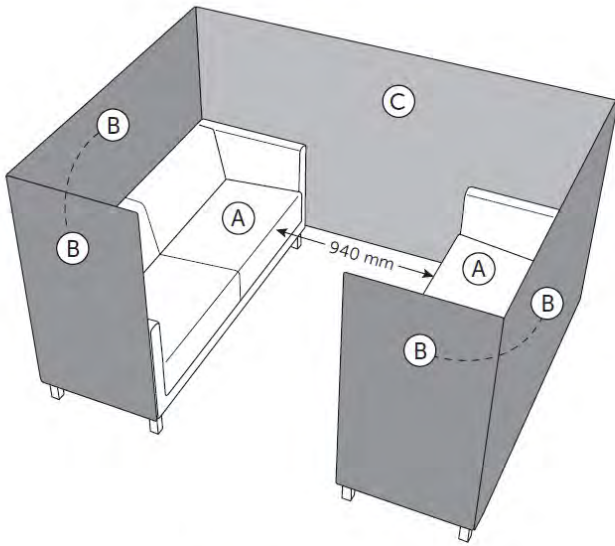

Sample of „U-shape” set with 3-seater sofas.

2 x A: VL 3 HW/VW  
(3-seat sofa, to be connected with partition walls)

2x B: VL W3  
(set of partition walls to be connected with 3-seater sofa)

1 x SW: VL SW  
(wall)

While ordering set of "U-shape" armchairs/sofas (including wall VL SW) please indicate clearly this option on your order.

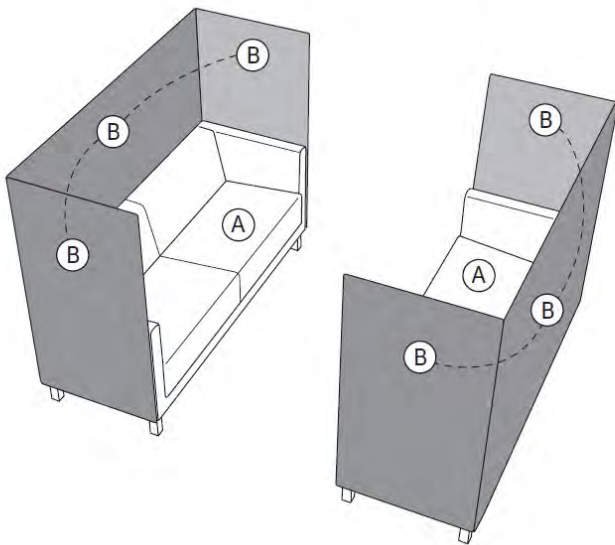









Sample of set with separate 3-seater sofas.

2 x A: VL 3 HW/VW  
(3-seat sofa, to be connected with partition walls)

2 x B: VL W3  
(set of partition walls to be connected with 3-seater sofa).

# Profim VANCOUVER OTO

- Available in two sizes and two shapes
- The set is also available as a pouffe + table in the version with an added glass top
- Possibility of connecting cubic pouffes by means of a linking element
- The mediaport is a complementary element

| Item no    | Base model +   | Price Group (PG)   | Price Group |       |       |       |       |       | Price |
|------------|--|--|-------------|-------|-------|-------|-------|-------|-------|
|            |  |  | 0           | ①     | ②     | ③     | ④     | ⑤     |       |
| MVOR200000 | Profim VANCOUVER OTO VOR2<br>• small round pouffe<br>• ø 410 mm      | <br>     | 1 761       | 1 834 | 2 019 | 2 109 | 2 201 | 2 568 | 2 753 |
| MVOR100000 | Profim VANCOUVER OTO VOR1<br>• large round pouffe<br>• ø 540 mm      | <br>     | 1 961       | 2 042 | 2 244 | 2 346 | 2 449 | 2 857 | 3 061 |
| MVOS200000 | Profim VANCOUVER OTO VOS2<br>• small square pouffe<br>• 410 x 410 mm | <br> | 1 920       | 2 212 | 2 795 | 2 196 | 2 291 | 3 659 | 5 056 |
| MVOS100000 | Profim VANCOUVER OTO VOS1<br>• large square pouffe<br>• 540 x 540 mm | <br> | 2 228       | 2 321 | 2 553 | 2 671 | 2 786 | 3 250 | 3 481 |

## Accessories/Options/Surcharges:

|          |   |       |
|----------|---|-------|
| 7TATO002 | Table top milky tempered glass (Only for: VOR1, VOR2)                     | 972   |
| 7TATO002 | Table top milky tempered glass (Only for: VOS1, VOS2)                     | 1 130 |
| 7ELEC004 | Mediaport - electrical outlet 230V and 2 USB ports (Only for: VOS1, VOS2) | 2 735 |
| 7QUEL006 | Quilting - outer surface (Q7)   | 1 069 |

**0 price group: Evo**

**1 price group: Cura, Tonal, Xtreme**

**2 price group: Select**

**3 price group: Capture, Oceanic, Step, Synergy**

**4 price group: Steelcut 3, Steelcut Trio 3**

**6 price group: Paloma**

Glides

Standard:

- hard glides - for soft floors.

Option:

- felt glides - for hard floors.

When ordering please clearly indicate the chosen option.

Table top G1 - lead time 20-30 working days.



Quilting - extra charge to all price groups, lead time 30-40 working days.







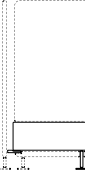

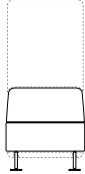
# Profim WALL IN

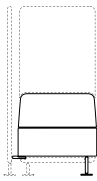
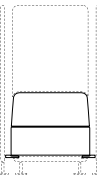

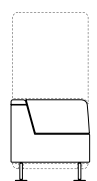
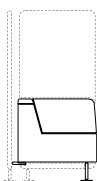
Tomek Rygalik, Studio Rygalik

- Walls enabling the division of the interior and the introduction of distance
- Possibility to choose upholstery colour
- Legs finished with aesthetic plates, available in three colours
- The mediaport is a complementary element

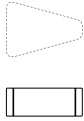
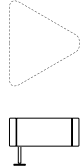
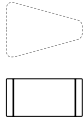
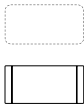
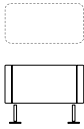
| Item no    | Base model +  | Price Group (PG)  | Price Group |       |       |       |       |       | Price |
|------------|---|---|-------------|-------|-------|-------|-------|-------|-------|
|            |   |   | 0           | ①     | ②     | ③     | ④     | ⑤     |       |
| MWA1000000 | Profim WALL IN 10<br>• pouffe<br>• frame: black / MetallicPro   |    | 4 260       | 4 437 | 4 880 | 5 102 | 5 325 | 6 211 | 6 657 |
| MWA1100000 | Profim WALL IN 11<br>• pouffe to be connected with 1 partition wall<br>• frame: black / MetallicPro   |    | 4 260       | 4 437 | 4 880 | 5 102 | 5 325 | 6 211 | 6 657 |
| MWA1200000 | Profim WALL IN 12<br>• pouffe to be connected with 2 partition walls<br>• frame: black / MetallicPro  |  | 4 402       | 4 586 | 5 044 | 5 276 | 5 502 | 6 421 | 6 879 |
| MWA1300000 | Profim WALL IN 13<br>• pouffe to be connected with 3 partition walls<br>• frame: black / MetallicPro  |  | 4 402       | 4 586 | 5 044 | 5 276 | 5 502 | 6 421 | 6 879 |
| MWA2000000 | Profim WALL IN 20<br>• armchair<br>• frame: black / MetallicPro                                       |  | 5 572       | 5 804 | 6 383 | 6 674 | 6 964 | 8 126 | 8 708 |
| MWA2100000 | Profim WALL IN 21<br>• armchair to be connected with 1 partition wall<br>• frame: black / MetallicPro |  | 5 572       | 5 804 | 6 383 | 6 674 | 6 964 | 8 126 | 8 708 |

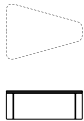
| Item no    | Base model +  | Price Group<br>(PG)   | Price Group |       |       |       |       |       | Price  |
|------------|---|---|-------------|-------|-------|-------|-------|-------|--------|
|            |   |   | 0           | ①     | ②     | ③     | ④     | ⑤     |        |
| MWA2200000 | Profim WALL IN 22<br><ul style="list-style-type: none"> <li>armchair to be connected with 2 partition walls</li> <li>frame: black / MetallicPro</li> </ul>        |    | 5 715       | 5 953 | 6 548 | 6 845 | 7 145 | 8 334 | 8 930  |
| MWA2300000 | Profim WALL IN 23<br><ul style="list-style-type: none"> <li>armchair to be connected with 3 partition walls</li> <li>frame: black / MetallicPro</li> </ul>        |    | 5 715       | 5 953 | 6 548 | 6 845 | 7 145 | 8 334 | 8 930  |
| MWA3000000 | Profim WALL IN 30<br><ul style="list-style-type: none"> <li>corner armchair</li> <li>frame: black / MetallicPro</li> </ul>  |    | 6 362       | 6 627 | 7 290 | 7 621 | 7 953 | 9 279 | 9 941  |
| MWA3100000 | Profim WALL IN 31<br><ul style="list-style-type: none"> <li>corner armchair to be connected with 1 partition wall</li> <li>frame: black / MetallicPro</li> </ul>  |  | 6 362       | 6 627 | 7 290 | 7 621 | 7 953 | 9 279 | 9 941  |
| MWA3200000 | Profim WALL IN 32<br><ul style="list-style-type: none"> <li>corner armchair to be connected with 2 partition walls</li> <li>frame: black / MetallicPro</li> </ul> |  | 6 507       | 6 777 | 7 455 | 7 794 | 8 132 | 9 488 | 10 166 |
| MWAW110000 | Profim WALL IN W11<br><ul style="list-style-type: none"> <li>single partition wall to be connected with 1 seat</li> <li>frame: black / MetallicPro</li> </ul>     |  | 2 840       | 2 958 | 3 254 | 3 401 | 3 550 | 4 142 |        |
| MWAW120000 | Profim WALL IN W12<br><ul style="list-style-type: none"> <li>single partition wall to be connected with 2 seats</li> <li>frame: black / MetallicPro</li> </ul>    |  | 2 840       | 2 958 | 3 254 | 3 401 | 3 550 | 4 142 |        |

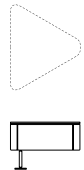
| Item no    | Base model +   | Price Group<br>(PG)   | Price Group |       |       |       |       |       | Price  |
|------------|--|---|-------------|-------|-------|-------|-------|-------|--------|
|            |  |   | 0           | ①     | ②     | ③     | ④     | ⑤     |        |
| MWAC100000 | Profim WALL IN C1<br>• pouffe<br>• 30°connector  |    | 2 606       | 2 714 | 2 986 | 3 123 | 3 257 | 3 800 | 4 073  |
| MWAC200000 | Profim WALL IN C2<br>• pouffe<br>• 60°connector<br>• frame: black / MetallicPro                |    | 3 361       | 3 501 | 3 852 | 4 025 | 4 201 | 4 900 | 5 252  |
| MWAP100000 | Profim WALL IN P1<br>• pouffe<br>• 30° armrest   |    | 2 805       | 2 921 | 3 213 | 3 360 | 3 505 | 4 088 | 4 381  |
| MWAP300000 | Profim WALL IN P3<br>• pouffe<br>• rectangular armrest   |  | 2 534       | 2 640 | 2 904 | 3 036 | 3 168 | 3 696 | 3 961  |
| MWAP400000 | Profim WALL IN P4<br>• pouffe<br>• rectangular armrest on legs<br>• frame: black / MetallicPro |  | 3 380       | 3 522 | 3 872 | 4 047 | 4 224 | 4 928 | 5 279  |
| MWAB000000 | Profim WALL IN B<br>• square table<br>• frame: black / MetallicPro                             |  | 5 033       | 5 243 | 5 767 | 6 028 | 6 291 | 7 338 | 7 862  |
| MWAB100000 | Profim WALL IN B1<br>• table<br>• 30°connector   |  | 6 633       | 6 909 | 7 600 | 7 944 | 8 290 | 9 670 | 10 361 |

| Item no    | Base model +  | Price Group (PG)  | Price Group |       |       |       |       |       | Price  |
|------------|---|---|-------------|-------|-------|-------|-------|-------|--------|
|            |   |   | 0           | ①     | ②     | ③     | ④     | ⑤     |        |
| MWAB200000 | Profim WALL IN B2<br>• table<br>• 60°connector<br>• frame: black / MetallicPro                              |  | 5 177       | 5 392 | 5 932 | 6 202 | 6 470 | 7 549 | 8 087  |
| MWABW10000 | Profim WALL IN BW1<br>• square table to be connected with 1 partition wall<br>• frame: black / MetallicPro  |  | 6 633       | 6 909 | 7 600 | 7 944 | 8 290 | 9 670 | 10 361 |
| MWABW20000 | Profim WALL IN BW2<br>• square table to be connected with 2 partition walls<br>• frame: black / MetallicPro |  | 5 033       | 5 243 | 5 767 | 6 028 | 6 291 | 7 338 | 7 862  |

#### Accessories/Options/Surcharges:

|          |   |       |
|----------|---|-------|
|          | Table top HPL (Only for: B, BW1, BW2)   | 1 981 |
|          | Table top HPL (Only for: B1)  | 1 653 |
|          | Table top HPL (Only for: B2)  | 2 309 |
| 7JIRO001 | Possibility of joining in rows  | 48    |
| 7ELEC004 | Mediaport - electrical outlet 230V and 2 USB ports (Only for: 10, 11, 12, 13, 20, 21, 22, 23, 30, 31, 32) | 2 795 |
| 7QUEL004 | Quilting - inner surface (Q6) (Only for: 10, 11, 12, 13, C2)  | 572   |
| 7QUEL004 | Quilting - inner surface (Q6) (Only for: 20, 21, 22, 23)  | 705   |
| 7QUEL004 | Quilting - inner surface (Q6) (Only for: 30, 31, 32)  | 790   |
| 7QUEL004 | Quilting - inner surface (Q6) (Only for: C1, P1, P3, P4)  | 413   |

**0 price group: Evo**

**1 price group: Cura, Tonal, Xtreme**

**2 price group: Select**

**3 price group: Capture, Oceanic, Step, Synergy**

**4 price group: Steelcut 3, Steelcut Trio 3**

**6 price group: Paloma**

Glides

Standard:

- metal glides - for soft floors.

Option:

- felt glides - for hard floors.

When ordering please clearly indicate the chosen option.

Model P4 (on legs) allows the completion of any system.

Glides and linking parts for partition walls are provided with the seat to be connected with the partition wall.

Wall In W11/W12 models never occur as freestanding elements.



Table top G1 - lead time 20-30 working days.

Colours of HPL (LW): White (LW01), Light Grey (LW03); Grey (LW04), Black (LW02), Navy Blue (LW06), Light Burgundy (LW07) - lead time 20-30 working days.

Quilting - extra charge to all price groups, lead time 30-40 working days.









Tables







Coat stands





Accessories

# Profim ALLROUND

- Table top in Laminate and Linoleum (24 mm) or Melamine Beech (22 mm)
- Table edge band will match table top colour as standard. Optionally choose black, white or grey table edge band to any table top colour within our rangewithout extra charge.

| Item no | Base model +   | Price Group (PG)  | ①     | ②     | ③     | Price |
|---------|--|---|-------|-------|-------|-------|
| 5180-30 | Profim ALLROUND 5180-30 (E) <ul style="list-style-type: none"> <li>• Tables, height 73/90 cm</li> <li>• 80 x 80 cm with column frame base with 4 star footbase</li> </ul>  |    | 3 246 | 4 383 | 5 697 |       |
| 5180-10 | Profim ALLROUND 5180-10 (E) <ul style="list-style-type: none"> <li>• Table, height 73/90 cm</li> <li>• 180 x 90 cm with T frame</li> <li>• Distance between legs 110 cm</li> </ul>   |    | 4 802 | 7 299 | 9 488 |       |
| 5180-22 | Profim ALLROUND 5180-22 (S) <ul style="list-style-type: none"> <li>• Table, height 73/90 cm</li> <li>• 180 x 80 cm with T frame</li> <li>• Distance between table legs 110 cm</li> </ul>                                       |   | 4 676 | 6 932 | 9 011 |       |
| 5180-24 | Profim ALLROUND 5180-24 (E) <ul style="list-style-type: none"> <li>• Table, height 73/90 cm</li> <li>• 160 x 80 cm with T frame</li> <li>• Distance between table legs 110 cm</li> </ul>                                       |  | 4 555 | 6 593 | 8 572 |       |
| 5180-25 | Profim ALLROUND 5180-25 (S) <ul style="list-style-type: none"> <li>• Table, height 73/90 cm</li> <li>• 140 x 80 cm with T frame</li> <li>• Distance between table legs 80 cm</li> <li>• Weight approx. 24.5 kg Lam.</li> </ul> |  | 4 436 | 6 500 | 8 450 |       |
| 5180-27 | Profim ALLROUND 5180-27 (S) <ul style="list-style-type: none"> <li>• Table, height 73/90 cm</li> <li>• 120 x 80 cm with T frame</li> <li>• Distance between table legs 80 cm</li> </ul>  |  | 4 349 | 6 290 | 8 176 |       |

| Item no  | Base model +   | Price Group (PG)  | ①     | ②     | ③     | Price |
|----------|--|---|-------|-------|-------|-------|
| 5180-36  | Profim ALLROUND 5180-36 (E) <ul style="list-style-type: none"> <li>• Table, height 73/90 cm</li> <li>• 180 x 70 cm with T frame</li> <li>• Distance between table legs 110 cm</li> </ul> |    | 4 555 | 6 567 | 8 538 |       |
| 5180-38  | Profim ALLROUND 5180-38 (S) <ul style="list-style-type: none"> <li>• Table, height 73/90 cm</li> <li>• 140 x 70 cm with T frame</li> <li>• Distance between table legs 80 cm</li> </ul>  |    | 4 373 | 6 350 | 8 255 |       |
| 5180-39  | Profim ALLROUND 5180-39 (S) <ul style="list-style-type: none"> <li>• Table, height 73/90 cm</li> <li>• 120 x 70 cm with T frame</li> <li>• Distance between table legs 80 cm</li> </ul>  |    | 4 260 | 5 997 | 7 795 |       |
| 5182-10  | Profim ALLROUND 5182-10 (E) <ul style="list-style-type: none"> <li>• Round table with frame base, height 50/73 cm</li> <li>• Ø60 cm - 4 star footbase</li> </ul>                         |  | 3 229 | 4 560 | 5 928 |       |
| 5182-102 | Profim ALLROUND 5182-102 (E) <ul style="list-style-type: none"> <li>• High table, height 90/110 cm</li> <li>• Ø60 cm - 4 star footbase</li> </ul>  |  | 3 444 | 4 728 | 6 146 |       |
| 5182-15  | Profim ALLROUND 5182-15 (S) <ul style="list-style-type: none"> <li>• Round table with frame base, height 50/73 cm</li> <li>• Ø70 cm - 4 star footbase</li> </ul>                         |  | 3 390 | 4 790 | 6 226 |       |
| 5182-152 | Profim ALLROUND 5182-152 (E) <ul style="list-style-type: none"> <li>• High table, height 90/110 cm</li> <li>• Ø70 cm - 4 star footbase</li> </ul>  |  | 3 556 | 4 954 | 6 441 |       |

| Item no  | Base model +   | Price Group (PG)  | ①     | ②     | ③      | Price |
|----------|--|---|-------|-------|--------|-------|
| 5182-20  | Profim ALLROUND 5182-20 (E) <ul style="list-style-type: none"> <li>• Round table with frame base, height 50/73 cm</li> <li>• Ø80 cm - 4 star footbase</li> </ul>   |    | 3 597 | 5 077 | 6 600  |       |
| 5182-202 | Profim ALLROUND 5182-202 (E) <ul style="list-style-type: none"> <li>• High table, height 90/110 cm</li> <li>• Ø80 cm - 4 star footbase</li> </ul>  |    | 3 767 | 5 242 | 6 813  |       |
| 5182-25  | Profim ALLROUND 5182-25 (E) <ul style="list-style-type: none"> <li>• Round table with frame base, height 50/73 cm</li> <li>• Ø100 cm - 5 star footbase</li> </ul>  |    | 4 123 | 5 908 | 7 680  |       |
| 5182-30  | Profim ALLROUND 5182-30 (E) <ul style="list-style-type: none"> <li>• Round table with frame base, height 50/73 cm</li> <li>• Ø120 cm - 5 star footbase</li> </ul>  |  | 4 456 | 6 603 | 8 584  |       |
| 5184-01  | Profim ALLROUND 5184-01 (E) <ul style="list-style-type: none"> <li>• Ellipse table</li> <li>• Height 73/90 cm</li> <li>• 180 x 100 cm with T frame, seats 6</li> <li>• Distance between table legs 110 cm</li> </ul> |  | 6 059 | 8 280 | 10 765 |       |

1. Melamine on chipboard (only beech)

2. Laminate on chipboard

3. Linoleum on chipboard

Height: 50/73/90/110 cm

Profim Allround table tops (rectangular and squared shapes) can be made available with MDF table core, chamfered edges of 20 degr and with a 10 mm black, white or grey edge band and black paint

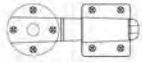

RS091003



S=Standard Collection - normal production time 20-30 working days. Applicable when table top and base are standard (S).

E=Extended Collection - normal production time 30-35 working days (Linoleum: 35 working days). Applicable when any or all component options selected are extended (E).





For larger orders, please contact Customer Service for delivery details.



MÖBELFAKTA

# Profim EMINENT

- Ø38 mm tubular table leg in various colours. See below Accessories/options. Incl. levelling feet (up to 17 mm on all legs)
- Table tops in various colours, see below Accessories/options.
- Table edge band will match table top colour as standard. Optionally choose black, white or grey table edge band to any table top colour within our range without extra charge.
- Table suspension brackets for several tables available for Profim Ana and Noor (except 6080/85). Cannot be attached to round tables

| Item no | Base model +  | Price Group (PG)  | ①     | ②     | ③     | Price |
|---------|---|---|-------|-------|-------|-------|
| 4590-22 | Profim EMINENT 4590-22<br>• 180 x 80 cm<br>• Distance between the table legs 164 cm<br>• Weight appr 33.2 kg Lam. |    | 4 646 | 5 729 | 7 447 |       |
| 4590-24 | Profim EMINENT 4590-24<br>• 160 x 80 cm<br>• Distance between the table legs 144 cm<br>• Weight appr 29.8 kg Lam. |    | 4 406 | 5 288 | 6 874 |       |
| 4590-25 | Profim EMINENT 4590-25<br>• 140 x 80 cm<br>• Distance between the table legs 124 cm<br>• Weight appr 27.3 kg Lam. |  | 4 420 | 5 300 | 6 892 |       |
| 4590-27 | Profim EMINENT 4590-27<br>• 120 x 80 cm<br>• Distance between the table legs 104 cm<br>• Weight appr 24.2 kg Lam. |  | 3 869 | 4 682 | 6 088 |       |
| 4590-30 | Profim EMINENT 4590-30<br>• 80 x 80 cm<br>• Distance between the table legs 64 cm<br>• Weight appr 18.7 kg Lam.   |  | 3 334 | 4 063 | 5 283 |       |

| Item no | Base model +  | Price Group (PG)  | ①     | ②     | ③     | Price |
|---------|---|---|-------|-------|-------|-------|
| 4590-38 | Profim EMINENT 4590-38<br>• 140 x 70 cm<br>• Distance between the table legs 124 cm<br>• Weight appr 25.2 kg Lam.       |    | 4 346 | 5 212 | 6 775 |       |
| 4590-52 | Profim EMINENT 4590-52<br>• 140 x 60 cm<br>• Distance between the table legs 124 cm<br>• Weight appr 23 kg Lam.         |    | 4 166 | 5 027 | 6 536 |       |
| 4590-54 | Profim EMINENT 4590-54<br>• 120 x 60 cm<br>• Distance between the table legs 104 cm<br>• Weight appr 20.4 kg Lam        |    | 3 250 | 4 245 | 5 518 |       |
| 4592-30 | Profim EMINENT 4592-30<br>• Ø120 cm with 4 legs<br>• Distance between the table legs 60 cm                              |  | 4 332 | 6 056 | 7 873 |       |
| 4592-50 | Profim EMINENT 4592-50<br>• Ø160 cm with 4 legs<br>• Distance between the table legs 91 cm                              |  | 6 681 |       |       |       |
| 4593-15 | Profim EMINENT 4593-15<br>• Trapezium 140 x 70 x 70 x 70, depth 60 cm<br>• Distance between the table legs 116/53/60 cm |  | 4 519 | 5 419 | 7 044 |       |

**1. Melamine on chipboard (only beech)**

**2. Laminate on chipboard**

**3. Linoleum on chipboard**

Table top in Laminate and Linoleum (24 mm) or Melamine Beech (22 mm)  
 Height approx. 73.5 cm. Table leg adjustment screw on legs



\*\* See separate page "Table/chair suspension bracket system" for details



S=Standard Collection – normal production time 20-30 working days. Applicable when table top and base are standard (S).

E=Extended Collection – normal production time 30-35 working days (Linoleum: 35 working days). Applicable when any or all component options selected are extended (E).

For larger orders, please contact Customer Service for delivery details.

## Table/chair suspension bracket system for Eminent table



| Table size<br>(Length x width) | Width between legs<br>(width chair) | Noor 6050/6055*<br>(M30410 Bracket) | Noor 6060/6065*<br>(M30410 Bracket) | Noor 6070/6075*<br>(M30410 Bracket) | Ana                              | Com H/V<br>(M30403 Bracket) |
|--------------------------------|-------------------------------------|-------------------------------------|-------------------------------------|-------------------------------------|----------------------------------|-----------------------------|
| 1200x600                       | 1046x(446)                          | 1                                   | 1                                   | 1                                   | 1 (M130350)                      | 1 or 2                      |
| 800x800                        | 646x(646)                           | 1 on both sides                     | 1 on both sides                     | 1 on both sides                     | 2 on same side<br>(M130355)      | 1 on both sides             |
| 1200x800                       | 1046                                | 1 on both sides                     | 1 on both sides                     | 1 or 2 on both sides                | 2 (1 on both sides)<br>(M130360) | 1 or 2 on both sides        |
| 1400x600                       | 1246                                | 1 or 2 on one side                  | 1 or 2 on one side                  | 1 or 2 on one side                  | 4 (2 on both sides)<br>(M130365) | 1 or 2                      |
| 1400x700                       | 1246                                | 1 or 2 on both sides                | 1 or 2 on both sides                | 1 or 2 on both sides                | -                                | 1 or 2 on both sides        |
| 1400x800                       | 1246                                | 1 or 2 on both sides                | 1 or 2 on both sides                | 1 or 2 on both sides                | -                                | 1 or 2 on both sides        |
| 1600x800                       | 1446                                | 1 or 2 on both sides                | 1 or 2 on both sides                | 1 or 2 on both sides                | -                                | 1 or 2 on both sides        |
| 1800x800                       | 1646                                | 1, 2 or 3 on both<br>sides          | 1 or 2 on both sides                | 1 or 2 on both sides                | 6 (3 on both sides)<br>(M130370) | 1, 2 or 3 on both<br>sides  |



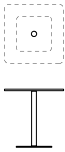
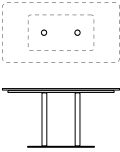
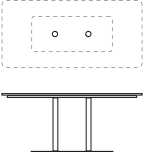

\* Valid for unupholstered chair, upholstered Seat (S), upholstered Seat and Back (SB) and Fully upholstered (F) variants. Table suspension bracket not applicable for Noor 6080/6085

# Profim REVO TABLES

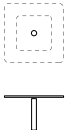
Pearson Lloyd

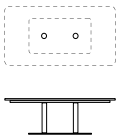
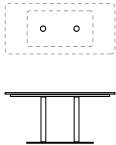
- tables and table frames of different length and height and shape
- designed with comfort in mind
- versatile and lightweight design
- various color palette of table tops and frames

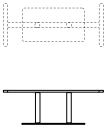
| Item no    | Base model +   | Price Group (PG)  | ①      | ②      | Price |
|------------|--|---|--------|--------|-------|
| MRVT750000 | Profim REVO T75<br>• table 750 x 750 mm<br>• height 740 mm<br>• square, flat base        |    | 8 642  | 9 201  |       |
| MRVT150000 | Profim REVO T150<br>• table 1500 x 750 mm<br>• height 740 mm<br>• rectangular, flat base |    | 16 190 | 16 955 |       |
| MRVT180000 | Profim REVO T180<br>• table 1800 x 850 mm<br>• height 740 mm<br>• rectangular, flat base |  | 18 644 | 20 310 |       |
| MRVLS65000 | Profim REVO LS65<br>• table 650 x 350 mm<br>• height 665 mm<br>• rectangular, flat base  |  | 5 809  | 6 174  |       |
| MRVLR48000 | Profim REVO LR48<br>• table round Ø 480 mm<br>• height 665 mm<br>• round base, flat base |  | 5 809  | 6 174  |       |
| MRVC750000 | Profim REVO C75<br>• low table 750 x 750 mm<br>• height 450 mm<br>• square, flat base    |  | 8 374  | 8 946  |       |

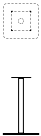
| Item no    | Base model +   | Price Group (PG)  | ①      | ②      | Price  |
|------------|--|---|--------|--------|--------|
| MRVC150000 | Profim REVO C150<br>• low table 1500 x 750 mm<br>• height 450 mm<br>• rectangular, flat base     |    | 15 643 | 16 396 |        |
| MRVT140000 | Profim REVO MT140<br>• medium table 1400 x 700 mm<br>• height 650 mm<br>• rectangular, flat base |    | 12 569 | 13 149 |        |
| MRVC75000F | Profim REVO FRAME C75<br>• table's frame<br>• height 440 mm<br>• square, flat base               |    |        |        | 5 253  |
| MRVC15000F | Profim REVO FRAME C150<br>• table's frame<br>• height 440 mm<br>• rectangular, flat base         |  |        |        | 10 156 |
| MRVLR4800F | Profim REVO FRAME LR48<br>• table's frame<br>• height 655 mm<br>• round base, flat base          |  |        |        | 4 295  |
| MRVLS6500F | Profim REVO FRAME LS65<br>• table's frame<br>• height 655 mm<br>• rectangular, flat base         |  |        |        | 4 460  |
| MRVT75000F | Profim REVO FRAME T75<br>• table's frame<br>• height 730 mm<br>• square, flat base               |  |        |        | 5 665  |

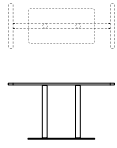
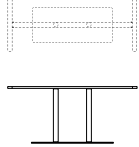
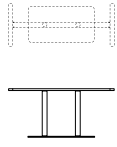
| Item no    | Base model +  | Price Group (PG)  | ① | ② | Price  |
|------------|---|---|---|---|--------|
| MRVT15000F | Profim REVO FRAME T150<br><ul style="list-style-type: none"> <li>• table's frame</li> <li>• height 730 mm</li> <li>• rectangular, flat base</li> </ul>        |  |   |   | 11 093 |
| MRVT18000F | Profim REVO TABLES FRAME T180<br><ul style="list-style-type: none"> <li>• table's frame</li> <li>• height 730 mm</li> <li>• rectangular, flat base</li> </ul> |  |   |   | 12 597 |
| MRVT14000F | Profim REVO FRAME MT140<br><ul style="list-style-type: none"> <li>• table's frame</li> <li>• height 640 mm</li> <li>• rectangular, flat base</li> </ul>       |  |   |   | 10 815 |

## **1. Natural veneers / Natural colored veneers (ash)Frame**

### **2. HPL**

MetallicPro; Black RAL 9005; White RAL 9016; Light Grey NCS S 2500 N; Grey NCS S 6500 N; Deep Green RAL 6004; Navy Blue RAL 5003; Burgundy RAL 3005; Salvia/Green RAL 6021, Blue RAL 5014; Terracota RAL 3012

#### **Natural veneers**

Ash (NA), Beech (NB), Oak (NO), Walnut (NW)

#### **Natural colored veneers (ash)**

White (CNA01), Black (CNA02), Dark green (CNA05), Navy blue (CNA06), Burgundy (CNA07)

#### **HPL**

White (LW01), Light Grey (LW03); Grey (LW04), Black (LW02), Navy Blue (LW06), Light Burgundy (LW07)

There is a possibility of any combination of the top and frame colors.

Natural veneers: Ash (NA); Beech (NB); Oak (NO); Orzech (NW) - delivery time 30 business days.

Natural colored veneers: delivery time 30 business days.

HPL worktops: delivery time 30 business days.

Frame in Revo Tables is dedicated for assembly table tops made only from chipboard, plywood or wood.

Maximum parameters of the table top:

C75- 750 x 750 mm, weight 4kg.

C150 - 1500 x 750 mm, weight 8 kg.

LR48 - Ø 480 mm, weight 1,5 kg.

LS65 - 350 x 650 mm, weight 2kg

T75 - 750 x 750 mm, weight 4kg.





T150 - 1500 x 750 mm, weight 8 kg.

T180 - 1800 x 850 mm, weight 11kg.

MT140 - 1400 x 700 mm, weight 7kg.







# Profim STANDARD FOLDING TABLE

- Folding table - 100 mm height when collapsed (with 22 mm table top)
- Frame in various colours. See below Accessories/options.
- For table top colours, see below Accessories/options.
- Table top edge band will match table top as standard. Optionally choose black, white or grey table edge band to any table top colour within our range without extra charge.
- Table top in Laminate (24 mm) or Melamine Beech (22 mm)

| Item no | Base model +  | Price Group (PG)  | ①     | ②     | ③     | Price |
|---------|---|---|-------|-------|-------|-------|
| 4680-10 | Profim STANDARD FOLDING TABLE<br>4680-10<br>• 180 x 90 cm<br>• Distance between the table legs 103 cm<br>• Weight appr 30.9 kg Lam. |    | 3 758 | 5 615 | 7 125 |       |
| 4680-15 | Profim STANDARD FOLDING TABLE<br>4680-15<br>• 120 x 90 cm<br>• Distance between the table legs 103 cm<br>• Weight appr 22.6 kg Lam. |    | 3 234 | 4 553 | 6 164 |       |
| 4680-22 | Profim STANDARD FOLDING TABLE<br>4680-22<br>• 180 x 80 cm<br>• Distance between the table legs 103 cm<br>• Weight appr 28.1 kg Lam. |  | 3 267 | 5 205 | 6 602 |       |
| 4680-24 | Profim STANDARD FOLDING TABLE<br>4680-24<br>• 160 x 80 cm<br>• Distance between the table legs 103 cm<br>• Weight appr 25.7 kg Lam. |  | 3 169 | 4 879 | 6 127 |       |
| 4680-25 | Profim STANDARD FOLDING TABLE<br>4680-25<br>• 140 x 80 cm<br>• Distance between the table legs 103 cm<br>• Weight appr 23.2 kg Lam. |  | 3 131 | 4 565 | 5 657 |       |

| Item no | Base model +  | Price Group (PG)  | ①     | ②     | ③     | Price |
|---------|---|---|-------|-------|-------|-------|
| 4680-27 | Profim STANDARD FOLDING TABLE<br>4680-27<br><ul style="list-style-type: none"> <li>• 120 x 80 cm</li> <li>• Distance between the table legs 103 cm</li> <li>• Weight appr 20.8 kg Lam.</li> </ul> |    | 2 708 | 4 196 | 5 014 |       |
| 4680-36 | Profim STANDARD FOLDING TABLE<br>4680-36<br><ul style="list-style-type: none"> <li>• 180 x 70 cm</li> <li>• Distance between the table legs 103 cm</li> <li>• Weight appr 25.4 kg Lam.</li> </ul> |    | 3 169 | 4 623 | 5 918 |       |
| 4680-38 | Profim STANDARD FOLDING TABLE<br>4680-38<br><ul style="list-style-type: none"> <li>• 140 x 70 cm</li> <li>• Distance between the table legs 103 cm</li> <li>• Weight appr 21.1 kg Lam.</li> </ul> |    | 2 869 | 4 123 | 5 154 |       |
| 4680-39 | Profim STANDARD FOLDING TABLE<br>4680-39<br><ul style="list-style-type: none"> <li>• 120 x 70 cm</li> <li>• Distance between the table legs 103 cm</li> <li>• Weight appr 18.9 kg Lam.</li> </ul> |  | 2 708 | 3 961 | 4 847 |       |
| 4680-52 | Profim STANDARD FOLDING TABLE<br>4680-52<br><ul style="list-style-type: none"> <li>• 140 x 60 cm</li> <li>• Distance between the table legs 103 cm</li> <li>• Weight appr 18.9 kg Lam.</li> </ul> |  | 3 021 | 4 153 | 4 797 |       |
| 4680-54 | Profim STANDARD FOLDING TABLE<br>4680-54<br><ul style="list-style-type: none"> <li>• 120 x 60 cm</li> <li>• Distance between the table legs 103 cm</li> <li>• Weight appr 17.1 kg Lam.</li> </ul> |  | 2 503 | 3 747 | 4 360 |       |



| Item no | Base model +   | Price Group (PG)  | ①    | ②    | ③    | Price |
|---------|--|---|------|------|------|-------|
| 4680-58 | Profim STANDARD FOLDING TABLE<br>4680-58<br><ul style="list-style-type: none"> <li>Exam table 90 x 60 cm</li> <li>Distance between the table legs 75 cm</li> <li>Weight appr 14.3 kg Lam.</li> </ul>         |    | 2256 | 3169 | 3727 |       |
| 4680-90 | Profim STANDARD FOLDING TABLE<br>4680-90<br><ul style="list-style-type: none"> <li>120 x 45 cm</li> <li>Distance between the table legs 103 cm</li> <li>Weight appr 14.3 kg Lam.</li> </ul>                  |    | 2329 | 3306 | 3838 |       |
| 4681-45 | Profim STANDARD FOLDING TABLE<br>4681-45<br><ul style="list-style-type: none"> <li>1/2 circle with folding frame, Ø160 cm</li> <li>Distance between the table legs 74 cm</li> </ul>                          |    | 3595 | 5503 | 5810 |       |
| 4688-52 | Profim STANDARD FOLDING TABLE<br>4688-52<br><ul style="list-style-type: none"> <li>L-frame</li> <li>140 x 60 cm</li> <li>Distance between the table legs 103 cm</li> <li>Weight appr 18.9 kg Lam.</li> </ul> |  | 3021 | 4153 | 4797 |       |
| 4688-54 | Profim STANDARD FOLDING TABLE<br>4688-54<br><ul style="list-style-type: none"> <li>L-frame</li> <li>120 x 60 cm</li> <li>Distance between the table legs 103 cm</li> <li>Weight appr 17.1 kg Lam.</li> </ul> |  | 2503 | 3747 | 4360 |       |
| 4688-90 | Profim STANDARD FOLDING TABLE<br>4688-90<br><ul style="list-style-type: none"> <li>L-frame</li> <li>120 x 45 cm</li> <li>Distance between the table legs 103 cm</li> <li>Weight appr 14.3 kg Lam.</li> </ul> |  | 2329 | 3306 | 3838 |       |

1. Melamine on chipboard (only beech)

2. Laminate on chipboard

Height, approx: 74.5 cm

Trolley with frame. 3211 for transport of 5 upright Profim Standard folding tables. 3212 for transport of 13 upright Profim Standard folding tables. Both trolleys can hold 12 tables lying down

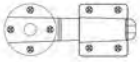
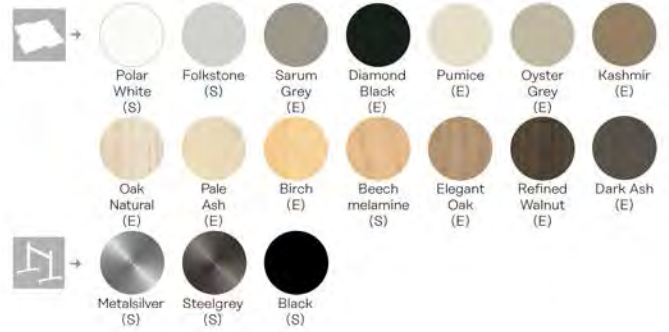

RS091003

S=Standard Collection - normal production time 20-30 working days. Applicable when table top and base are standard (S).

E=Extended Collection - normal production time 30-35 working days. Applicable when any or all component options selected are extended (E).

For larger orders, please contact Customer Service for delivery details.





Lightweight core on request.







# Profim U-CONNECT

Acer Design a/s, Justus Kolberg, Erik Simonsen

- Folding tables
- A smart mobile folding table with wheels and can nest together when lined up in the vertical position. The table top is anchored with a bracket in the upright position. The table top can be tipped along its long axis
- Table top edge band will match table top colour as standard. Optionally choose black, white or grey table edge band to any table top colour within our range without extra charge.
- Table top in Laminate or Linoleum (24 mm) and Melamine Beech (22 mm)

| Item no | Base model +   | Price Group (PG)  | ①     | ②     | ③      | ④      | Price |
|---------|--|---|-------|-------|--------|--------|-------|
| 3490-22 | Profim U-CONNECT 3490-22 <ul style="list-style-type: none"> <li>• 180 x 80 cm</li> <li>• Distance between the table legs 163 cm</li> <li>• Weight appr 31.6 kg Lam.</li> </ul> |    | 7 843 | 9 698 | 11 082 | 12 608 |       |
| 3490-36 | Profim U-CONNECT 3490-36 <ul style="list-style-type: none"> <li>• 180 x 70 cm</li> <li>• Distance between the table legs 163 cm</li> <li>• Weight appr 28.7 kg Lam.</li> </ul> |   | 7 755 | 9 477 | 10 669 | 12 320 |       |
| 3490-24 | Profim U-CONNECT 3490-24 <ul style="list-style-type: none"> <li>• 160 x 80 cm</li> <li>• Distance between the table legs 143 cm</li> <li>• Weight appr 28.7 kg Lam.</li> </ul> |  | 7 132 | 8 817 | 10 076 | 11 462 |       |
| 3490-37 | Profim U-CONNECT 3490-37 <ul style="list-style-type: none"> <li>• 160 x 70 cm</li> <li>• Distance between the table legs 143 cm</li> <li>• Weight appr 26.1 kg Lam.</li> </ul> |  | 7 049 | 8 613 | 9 698  | 11 197 |       |
| 3490-25 | Profim U-CONNECT 3490-25 <ul style="list-style-type: none"> <li>• 140 x 80 cm</li> <li>• Distance between the table legs 123 cm</li> <li>• Weight appr 25.4 kg Lam.</li> </ul> |  | 6 483 | 8 016 | 9 158  | 10 422 |       |

| Item no | Base model +  | Price Group (PG)  | ①     | ②     | ③     | ④      | Price |
|---------|---|---|-------|-------|-------|--------|-------|
| 3490-38 | Profim U-CONNECT 3490-38<br>• 140 x 70 cm<br>• Distance between the table legs 123 cm<br>• Weight appr 23.2 kg Lam. |    | 6 410 | 7 836 | 8 817 | 10 187 |       |
| 3490-52 | Profim U-CONNECT 3490-52<br>• 140 x 60 cm<br>• Distance between the table legs 123 cm<br>• Weight appr 21 kg Lam.   |    | 6 335 | 7 697 | 8 483 | 10 006 |       |
| 3490-27 | Profim U-CONNECT 3490-27<br>• 120 x 80 cm<br>• Distance between the table legs 103 cm<br>• Weight appr 22.6 kg Lam. |    | 6 384 | 7 795 | 8 752 | 10 134 |       |
| 3490-39 | Profim U-CONNECT 3490-39<br>• 120 x 70 cm<br>• Distance between the table legs 103 cm<br>• Weight appr 21.6 kg Lam. |  | 6 511 | 7 637 | 8 460 | 9 929  |       |
| 3490-54 | Profim U-CONNECT 3490-54<br>• 120 x 60 cm<br>• Distance between the table legs 103 cm<br>• Weight appr 18.5 kg Lam. |  | 6 261 | 7 479 | 8 167 | 9 722  |       |

**1. Melamine on chipboard (only beech)**

**2. Laminate on chipboard**

**3. Linoleum on chipboard**

Height 73.5 cm

Features Ø65 mm castors with soft rim and brake

Profim u-Connect table tops (rectangular and squared shapes) can be made available with MDF table core, chamfered edges of 20 degr and with a 10 mm black, white or grey edge band and black paint (see extra charge below)



RBM u-Connect

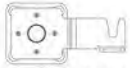

115000338008

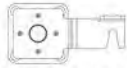

115000338009



S=Standard Collection – normal production time 20-30 working days. Applicable when table top and base are standard (S).

E=Extended Collection – normal production time 30-35 working days (Linoleum: 35 working days). Applicable when any or all component options selected are extended (E).

For larger orders, please contact Customer Service for delivery details.

Lightweight core on request.



MÖBELFAKTA

# Profim SEVEN

Tomek Rygalik, Studio Rygalik

- Option of combining colours, it is possible to play with colours (hanger and hooks are available in different shades)

| Item no    | Base model +                  | Price Group (PG)  | Coat hanger | Price |
|------------|-------------------------------|---|-------------|-------|
| MSZ0000000 | Profim SEVEN<br>• coat hanger |  | 2002        |       |

Hard glides - for soft floors (set).



Colours of frame:

- Black RAL 9005
- MetallicPro
- White RAL 9016
- Lightgrey NCS S 2500-N
- Grey NCS S 6500-N
- Deep green RAL 6004
- Navy blue RAL 5003
- Burgundy RAL 3005
- Salvia/Green RAL 6021
- Blue RAL 5014
- Terracota RAL 3012
- Steelgray

It is possible to order hooks in different colour than the coat stand frame.

# Profim CUSHION

- Two sizes
- Several types of fabric

| Item no    | Base model +   | Price Group (PG)  | ①   | ②   | ③   | ④     | Price |
|------------|--|---|-----|-----|-----|-------|-------|
| MCU3000000 | Profim CUSHION CU30<br>• cushions with filling<br>• 300 x 300 mm |  | 461 | 717 | 754 | 1 130 |       |
| MCU4000000 | Profim CUSHION CU40<br>• cushions with filling<br>• 400 x 400 mm |  | 547 | 790 | 826 | 1 325 |       |

**1 price group: Cura, Tonal, Xtreme**

**2 price group: Select**

**3 price group: Capture, Oceanic, Step, Synergy**

**4 price group: Steelcut 3, Steelcut Trio 3**

Filling: silicon.

Weight:

CU30 - 0,15 kg,

CU40 - 0,25 kg.

Colour of pillowcase is always white.

# Allround

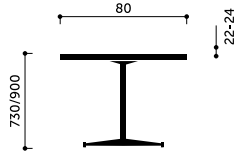

**Allround 5180-30**

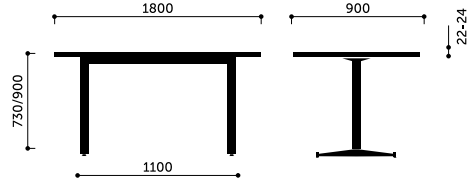

**Allround 5180-10**

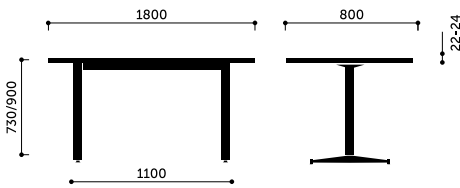

**Allround 5180-22**

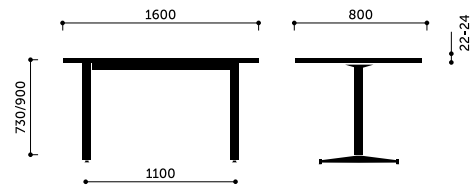

**Allround 5180-24**

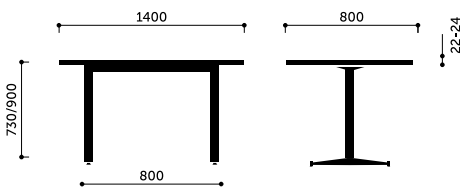

**Allround 5180-25**

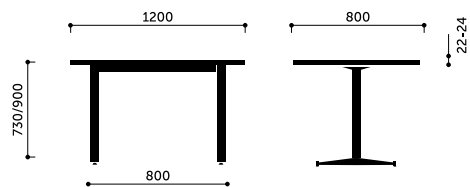

**Allround 5180-27**



# Technical details

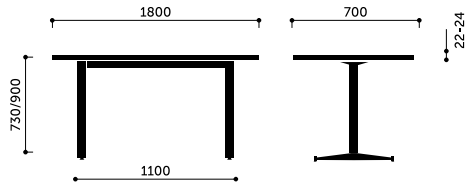

**Allround 5180-36**

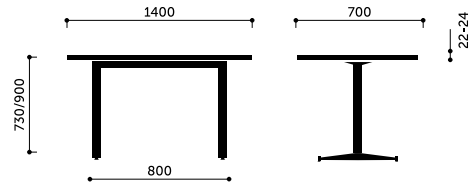

**Allround 5180-38**

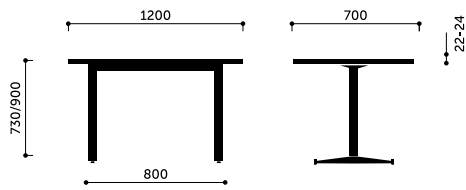

**Allround 5180-39**

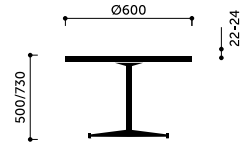

**Allround 5182-10**

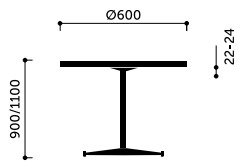

**Allround 5182-102**

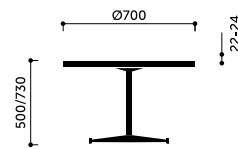

**Allround 5182-15**

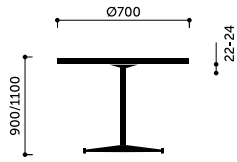

**Allround 5182-152**

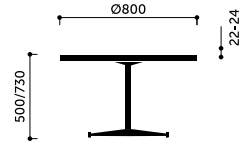

**Allround 5182-20**

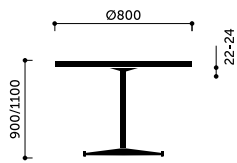

**Allround 5182-202**

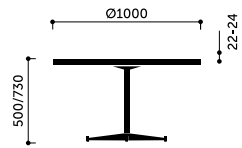

**Allround 5182-25**

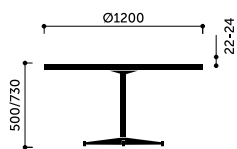

**Allround 5182-30**

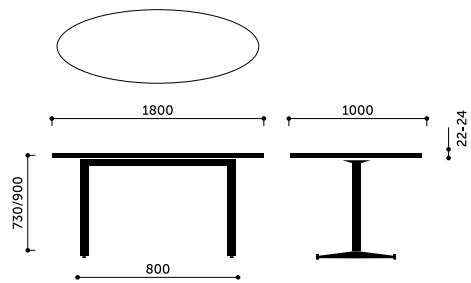

**Allround 5184-01**

# Technical details

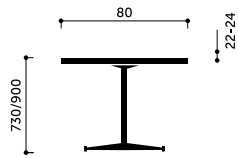

**Allround 5180-30**

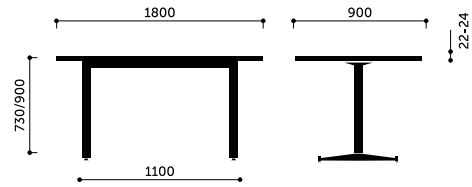

**Allround 5180-10**

# Ana

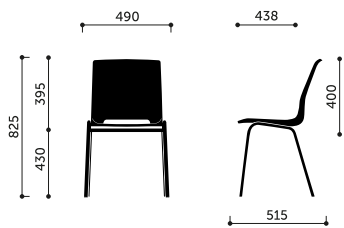

**4340 / 4340S / 4340SR**

# Ariz

550V 580  
550V 2P 610  
470  
450  
420 (450)

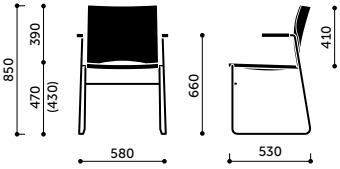

**550V / 550V 2P**

555V 580  
555V 2P 610  
470  
450  
410 (450)

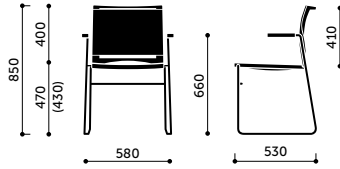

**555V / 555V 2P**

560V 580  
560V 2P 610  
470  
460  
430 (470)

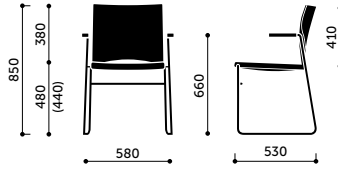

**560V / 560V 2P**

|      |         |    |     |                     |
|------|---------|----|-----|---------------------|
| V    | kg 10,5 | 15 | 710 | 1090                |
|      | kg 6,5  | 45 |     |                     |
| V 2P | kg 12,0 | 10 | 650 | 0,50 m <sup>3</sup> |
|      | kg 8,0  | 45 |     |                     |

|      |         |    |     |                     |
|------|---------|----|-----|---------------------|
| V    | kg 10,0 | 15 | 710 | 1090                |
|      | kg 6,0  | 45 |     |                     |
| V 2P | kg 11,5 | 10 | 650 | 0,50 m <sup>3</sup> |
|      | kg 7,5  | 45 |     |                     |

|      |         |    |     |                     |
|------|---------|----|-----|---------------------|
| V    | kg 11,0 | 5  | 710 | 1090                |
|      | kg 7,0  | 20 |     |                     |
| V 2P | kg 12,5 | 5  | 650 | 0,50 m <sup>3</sup> |
|      | kg 8,5  | 20 |     |                     |

570V 580  
570V 2P 610  
500  
460  
420 (470)

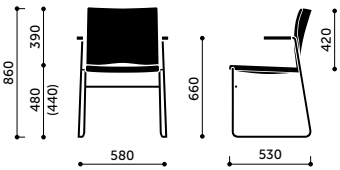

**570V / 570V 2P**

575V 580  
575V 2P 610  
470  
460  
420 (470)

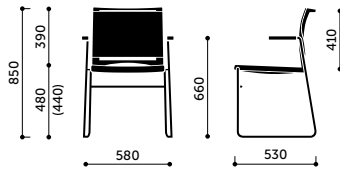

**575V / 575V 2P**

|      |         |    |     |                     |
|------|---------|----|-----|---------------------|
| V    | kg 11,5 | 5  | 710 | 1090                |
|      | kg 7,5  | 20 |     |                     |
| V 2P | kg 13,0 | 5  | 650 | 0,50 m <sup>3</sup> |
|      | kg 9,0  | 20 |     |                     |

|      |         |    |     |                     |
|------|---------|----|-----|---------------------|
| V    | kg 10,5 | 5  | 710 | 1090                |
|      | kg 6,5  | 20 |     |                     |
| V 2P | kg 12,0 | 5  | 650 | 0,50 m <sup>3</sup> |
|      | kg 8,0  | 20 |     |                     |

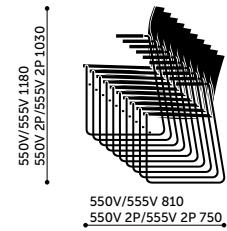

**stacking**

# Technical details

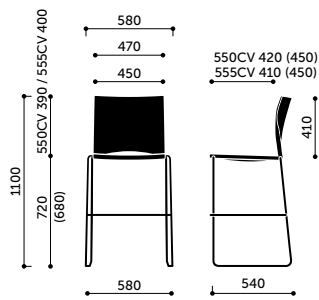

**550CV / 555CV**

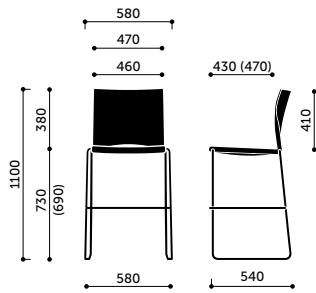

**560CV**

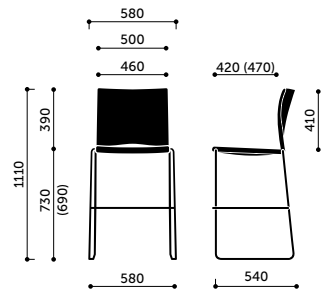

**570CV / 575CV**

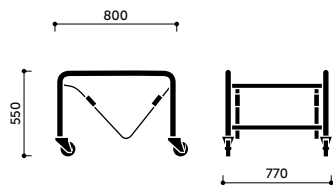
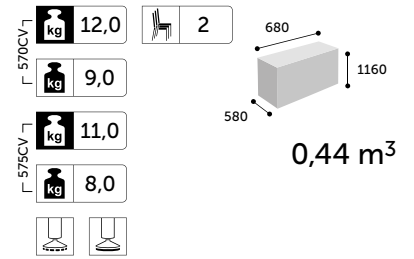
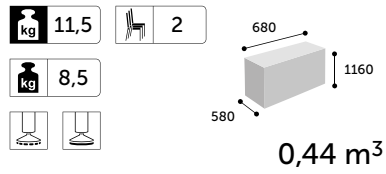
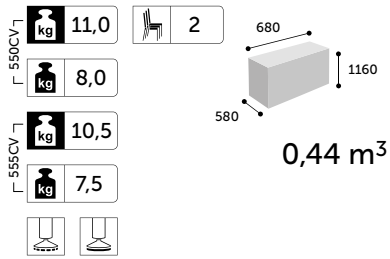

**W (chairs trolley)**

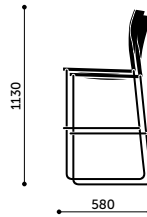

**stacking CV**

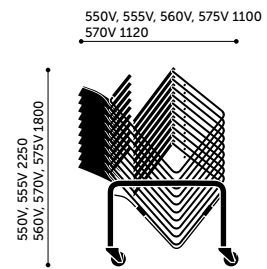

**stacking on trolley**

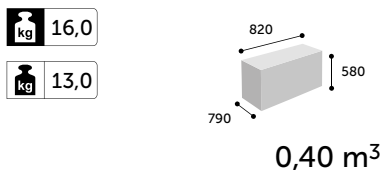

# Bit

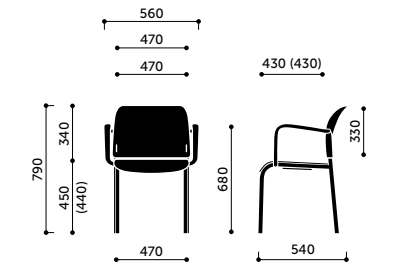

**550H / 550H 2P**

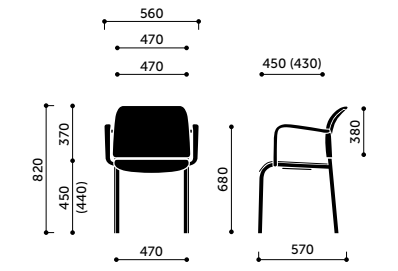

**555H / 555H 2P**

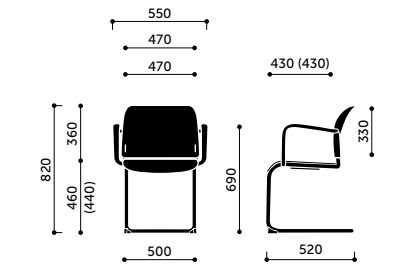

**550V / 550V 2P**

**9,5** kg  
**5**  
**710**  
**1090**  
**0,50 m<sup>3</sup>**

**5,5** kg  
**10,0** kg  
**6,0** kg

**550H**  
**550H 2P**

**9,5** kg  
**5**  
**710**  
**1090**  
**0,50 m<sup>3</sup>**

**5,5** kg  
**10,0** kg  
**6,0** kg

**555H**  
**555H 2P**

**11,5** kg  
**3**  
**710**  
**1090**  
**0,50 m<sup>3</sup>**

**7,5** kg  
**12,5** kg  
**8,5** kg

**550V**  
**550V 2P**

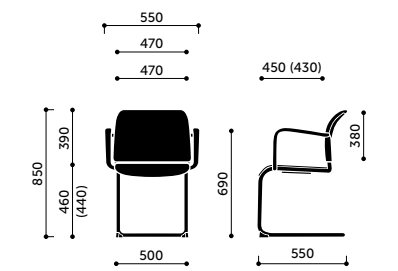

**555V / 555V 2P**

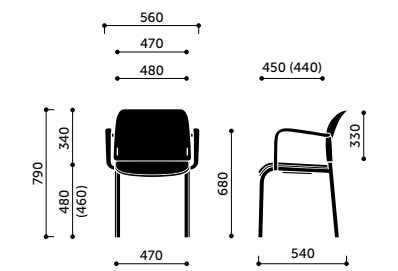

**560H / 560H 2P**

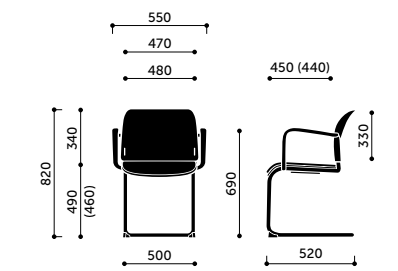

**560V / 560V 2P**

**11,5** kg  
**3**  
**710**  
**1090**  
**0,50 m<sup>3</sup>**

**7,5** kg  
**12,5** kg  
**8,5** kg

**555V**  
**555V 2P**

**10,5** kg  
**3**  
**710**  
**1090**  
**0,50 m<sup>3</sup>**

**6,5** kg  
**11,0** kg  
**7,0** kg

**560H**  
**560H 2P**

**12,0** kg  
**3**  
**710**  
**1090**  
**0,50 m<sup>3</sup>**

**8,0** kg  
**13,0** kg  
**9,0** kg

**560V**  
**560V 2P**

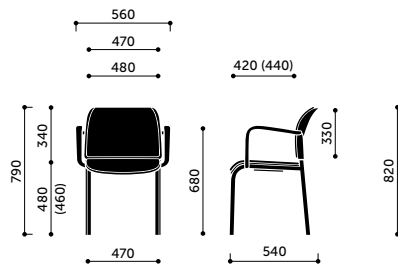

**570H / 570H 2P**

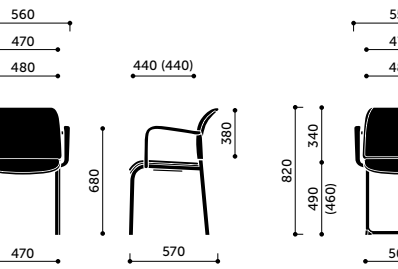

**575H / 575H 2P**

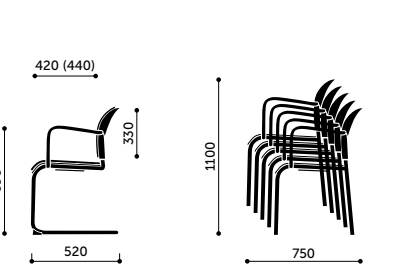

**570V / 570V 2P**

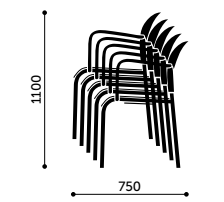

**stacking H**

**11,0** kg  
**3**  
**710**  
**1090**  
**0,50 m<sup>3</sup>**

**7,0** kg  
**11,5** kg  
**7,5** kg

**570H**  
**570H 2P**

**10,5** kg  
**3**  
**710**  
**1090**  
**0,50 m<sup>3</sup>**

**6,5** kg  
**11,0** kg  
**7,0** kg

**575H**  
**575H 2P**

**12,5** kg  
**3**  
**710**  
**1090**  
**0,50 m<sup>3</sup>**

**8,5** kg  
**13,5** kg  
**9,5** kg

**570V**  
**570V 2P**

# Technical details

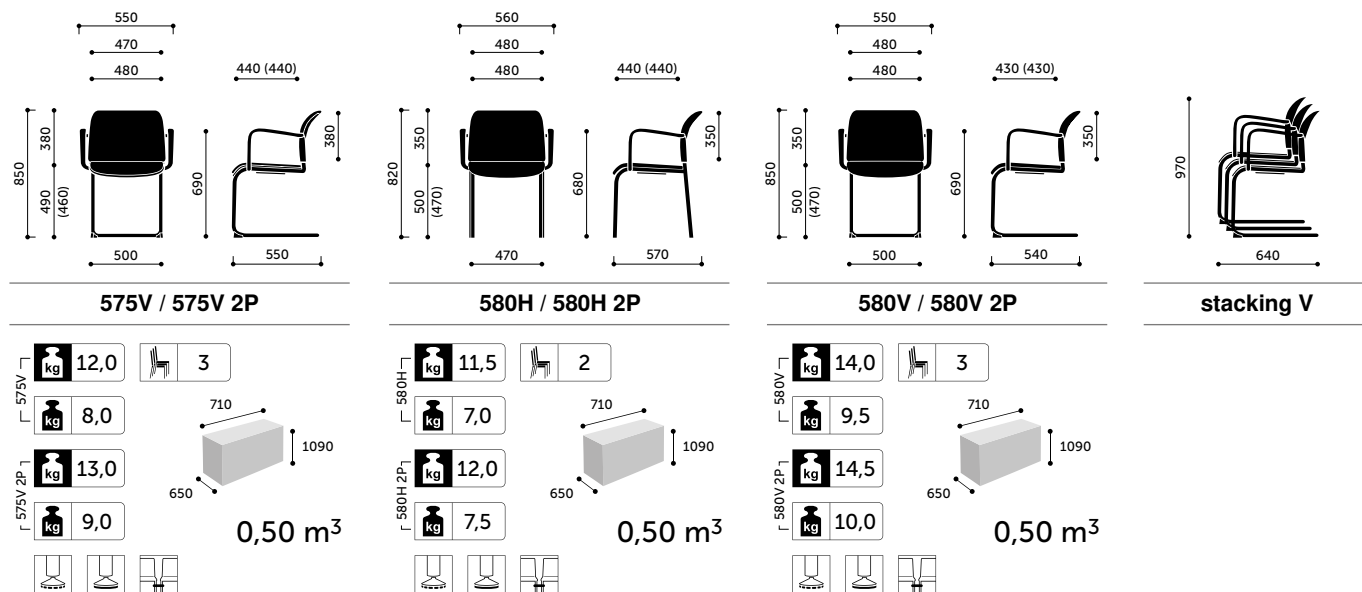

# Chic

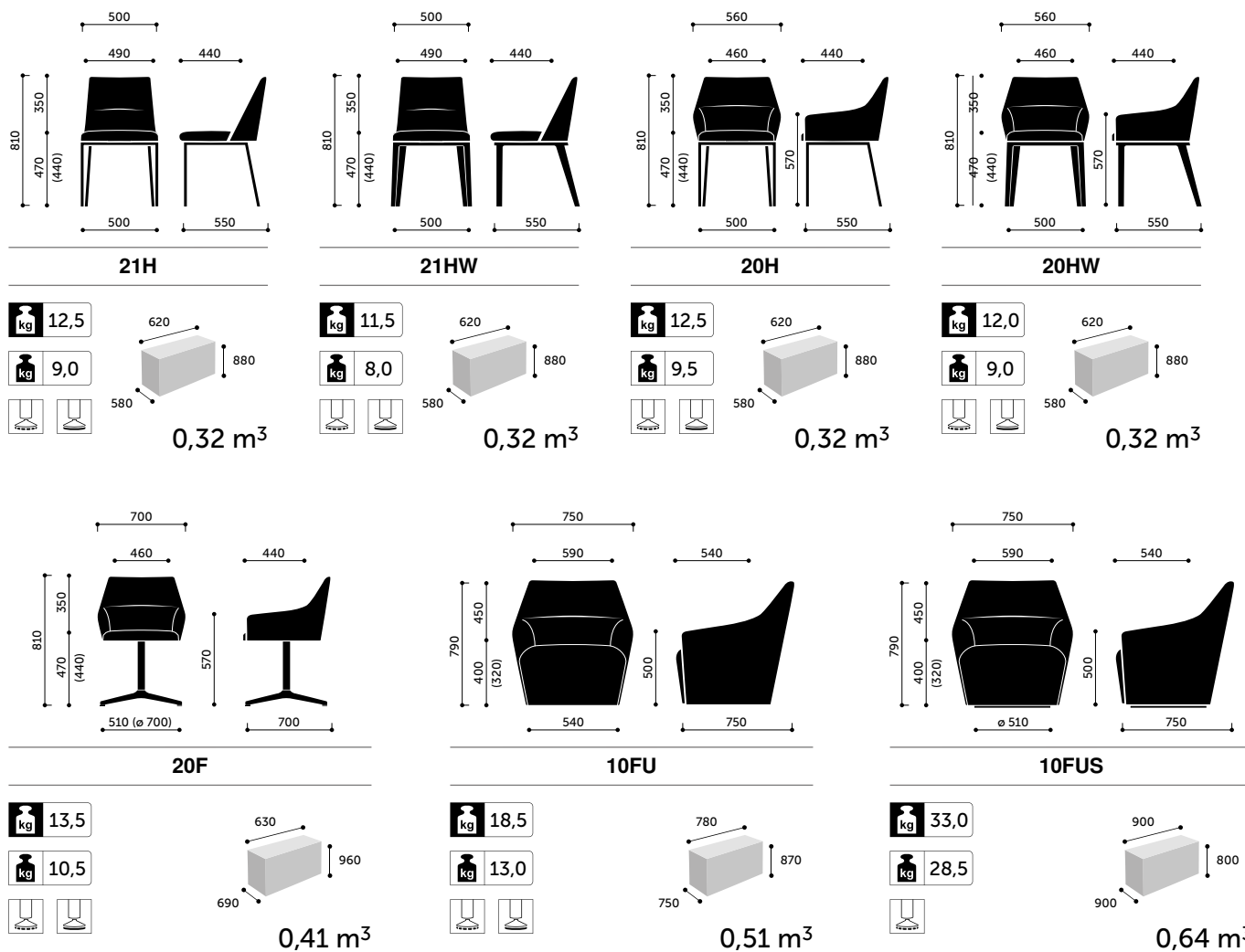

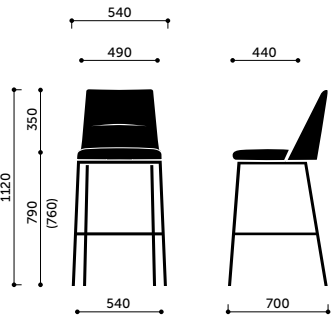

**21CH**

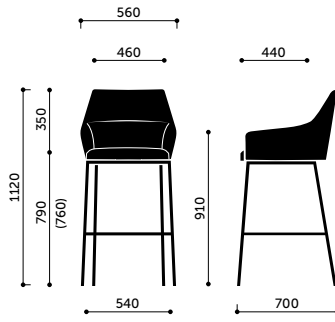
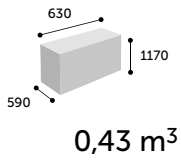
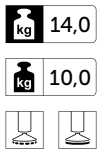

**20CH**

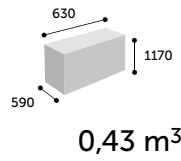
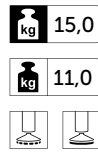

**Chic Lounge**

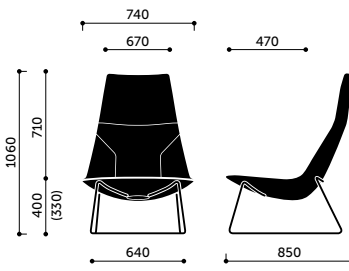

**A10V3**

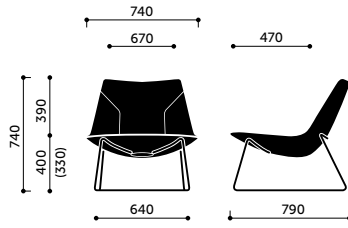
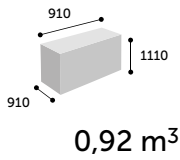
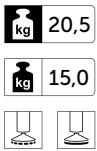

**A20V3**

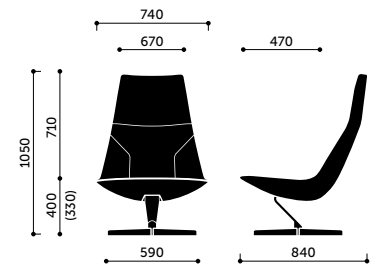
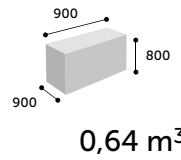
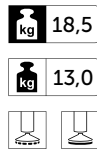

**A10F**

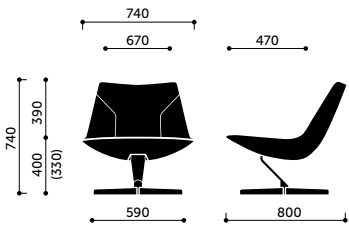
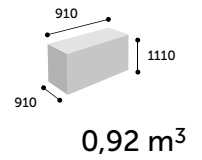
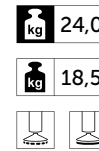

**A20F**

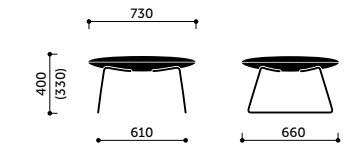
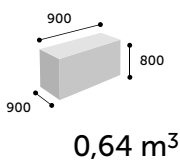
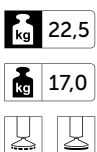

**PV3**

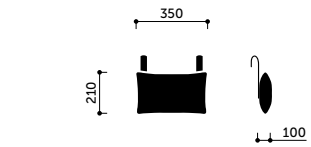
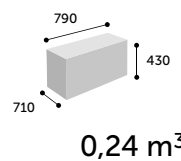
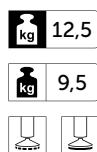

**CU**

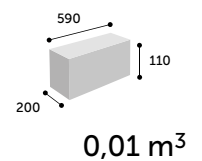
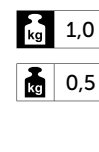



# Technical details

## Com

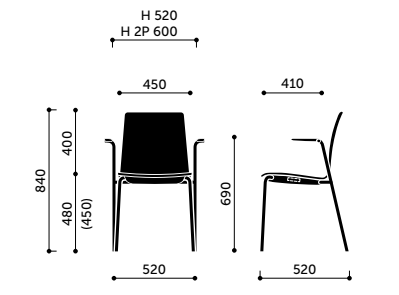

**K12H / K12H 2P**

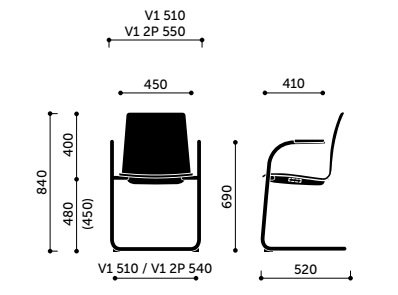
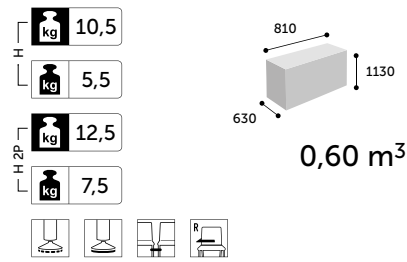

**K12V1 / K12V1 2P**

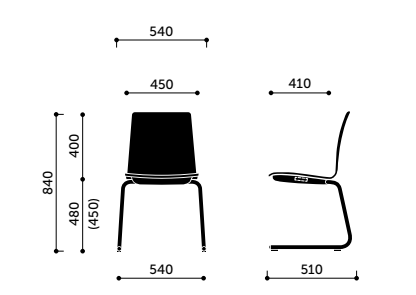
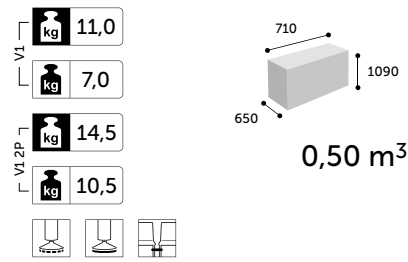

**K12V2**

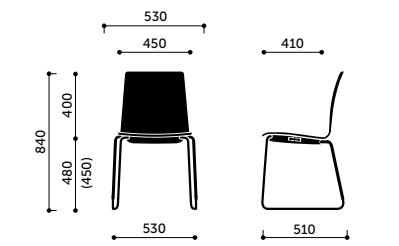
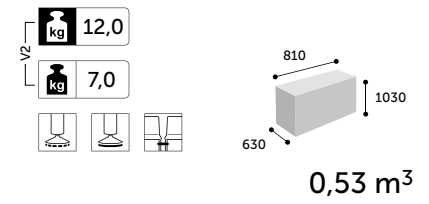

**K12V**

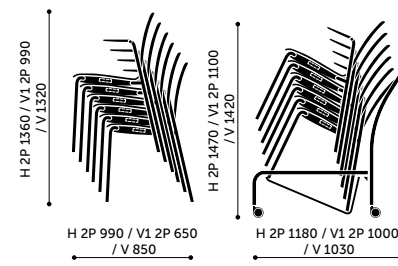
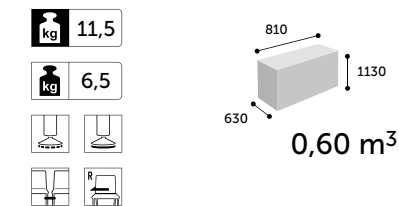

**stacking K12**

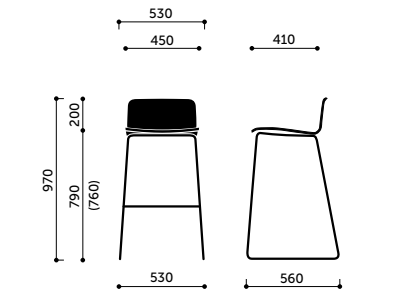
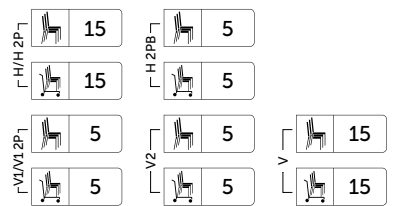

**K12CV**

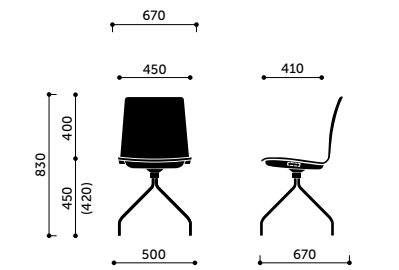
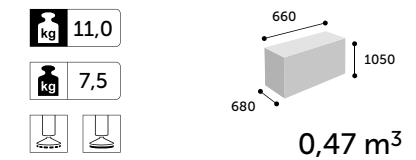

**K12HF/HS**

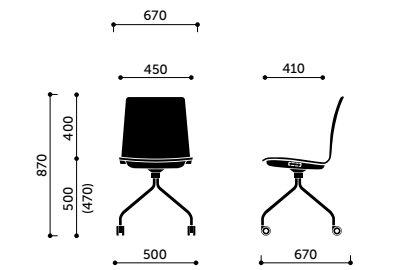
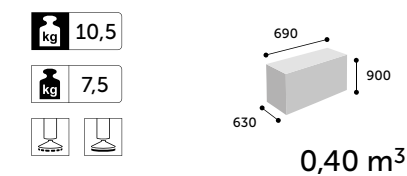

**K12HC**

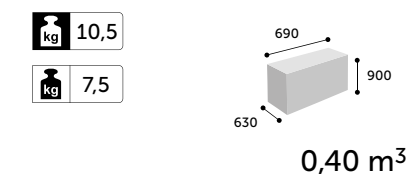

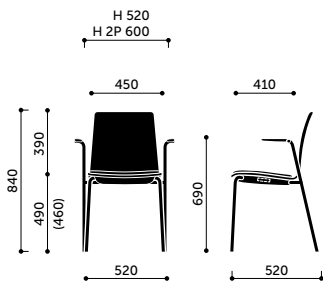

**K22H / K22H 2P**

- 11,0
- 6,0
- 13,0
- 8,0

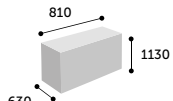

0,60 m<sup>3</sup>

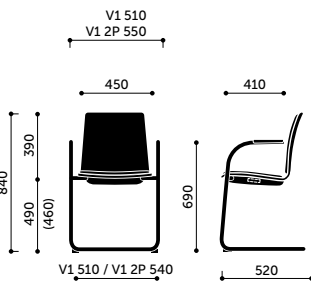

**K22V1 / K22V1 2P**

- 11,5
- 7,5
- 15,0
- 11,0

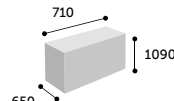

0,50 m<sup>3</sup>

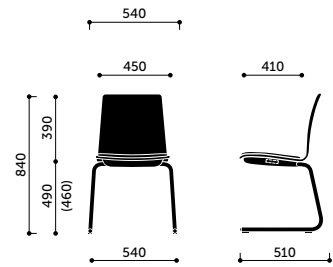

**K22V2**

- 12,5
- 7,5

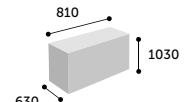

0,53 m<sup>3</sup>

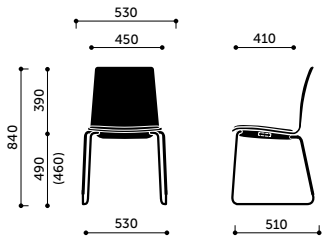

**K22V**

- 12,0
- 7,0

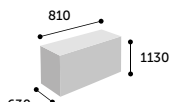

0,60 m<sup>3</sup>

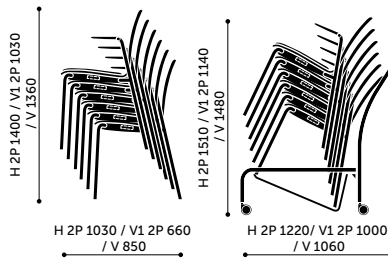

**stacking K22**

- 12
- 12
- 5
- 5
- 5
- 5
- 12
- 12

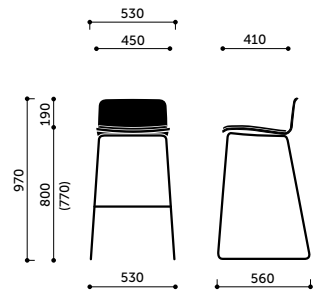

**K22CV**

- 11,5
- 8,0

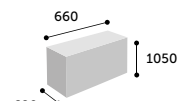

0,47 m<sup>3</sup>

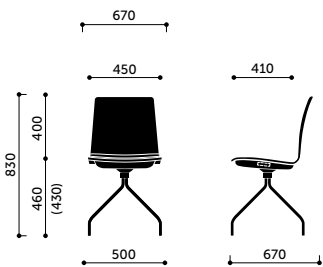

**K22HF/HS**

- 11,0
- 8,0

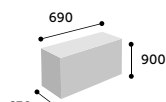

0,40 m<sup>3</sup>

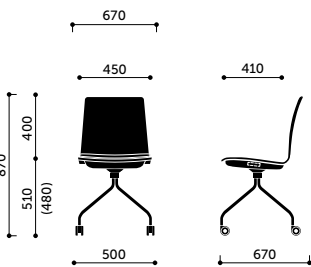

**K22HC**

- 11,0
- 8,0

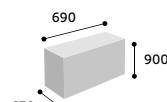

0,40 m<sup>3</sup>



# Technical details

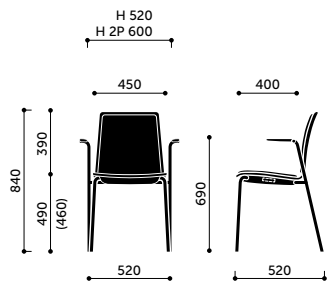

**K32H / K32H 2P**

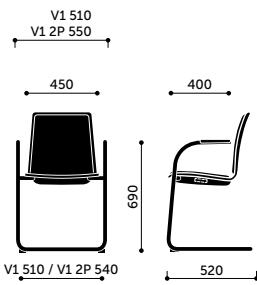
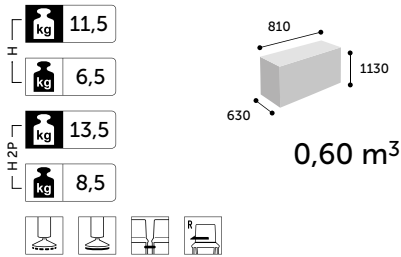

**K32V1 / K32V1 2P**

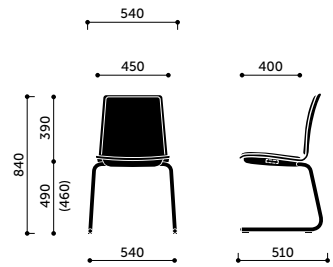
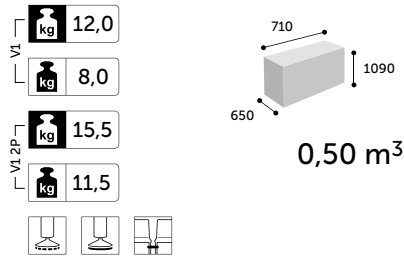

**K32V2**

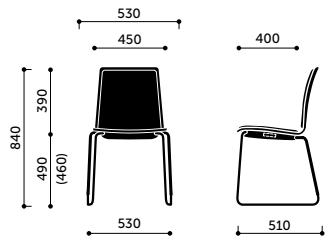
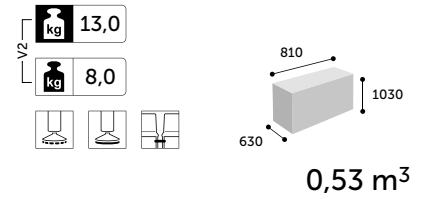

**K32V**

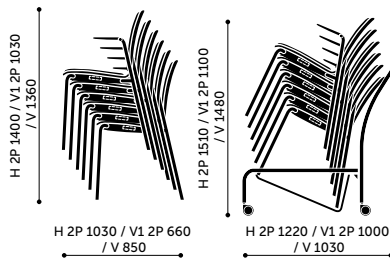
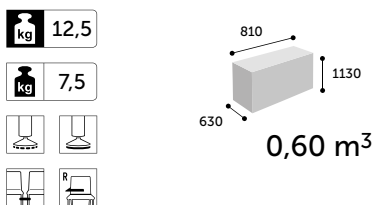

**stacking K32**

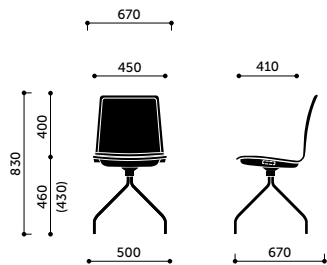
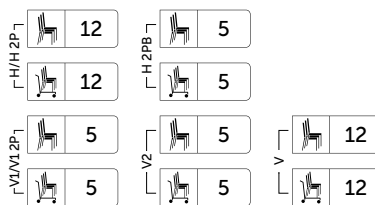

**K32HF/HS**

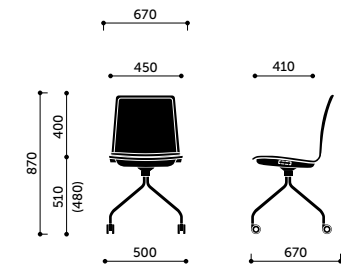
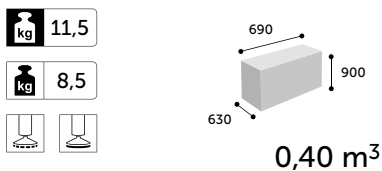

**K32HC**

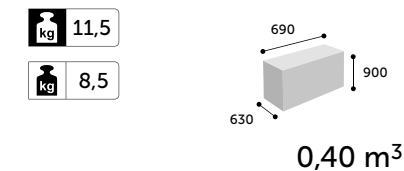

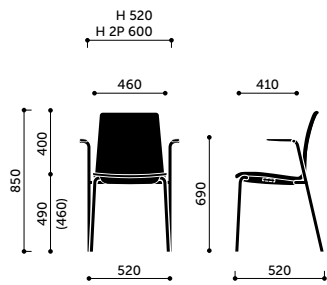

**K42H / K42H 2P**

- 11,0
- 6,0
- 13,0
- 8,0

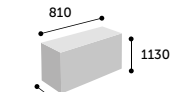

0,60 m<sup>3</sup>

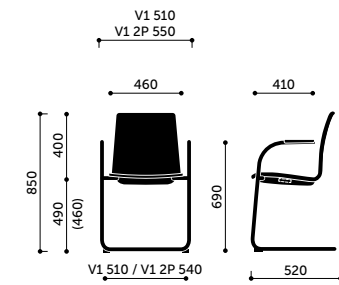

**K42V1 / K42V1 2P**

- 11,5
- 7,5
- 15,0
- 11,0

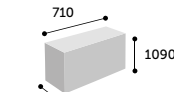

0,50 m<sup>3</sup>

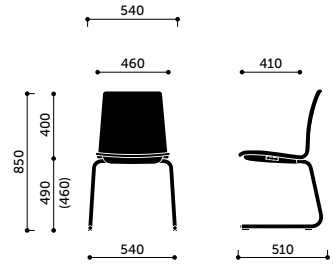

**K42V2**

- 12,5
- 7,5

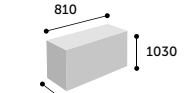

0,53 m<sup>3</sup>

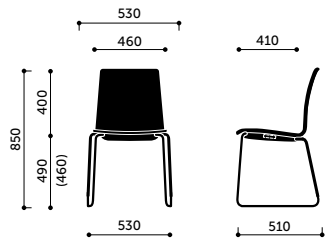

**K42V**

- 12,0
- 7,0

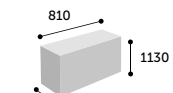

0,60 m<sup>3</sup>

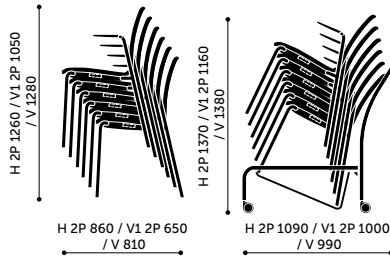

**stacking K42**

- 10
- 10
- 5
- 5
- 5
- 5
- 10
- 10

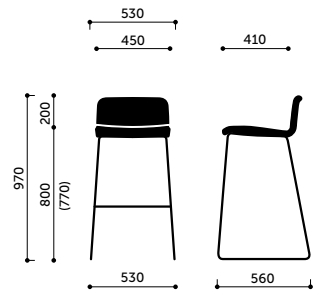

**K42CV**

- 11,5
- 8,0

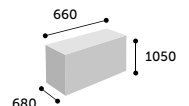

0,47 m<sup>3</sup>

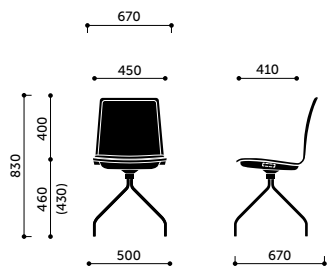

**K32HF/HS**

- 11,5
- 8,5

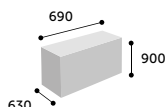

0,40 m<sup>3</sup>

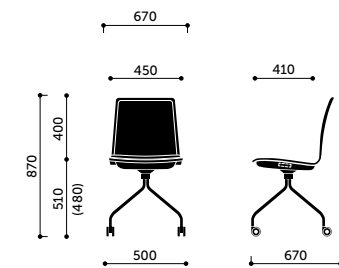

**K32HC**

- 11,5
- 8,5

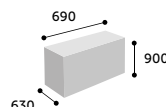

0,40 m<sup>3</sup>

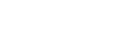

# Technical details

## Ellie<sup>Pro</sup>

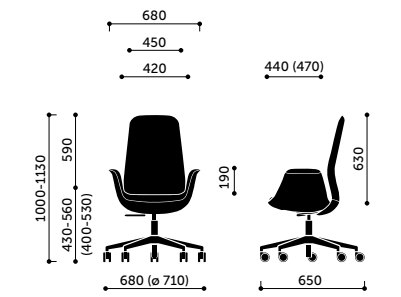

10ST

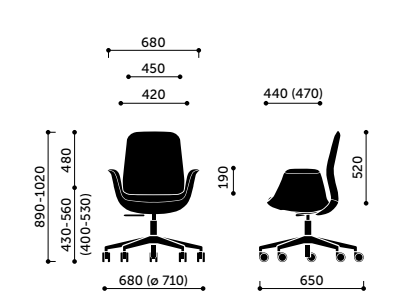

20ST

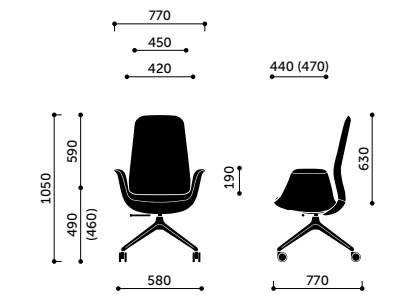

10HST

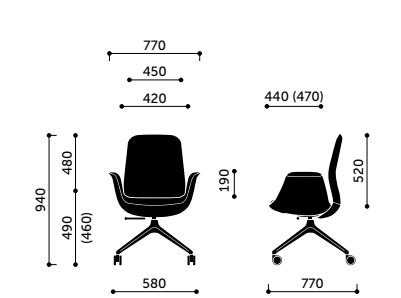
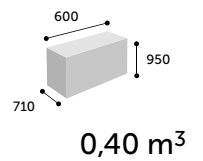
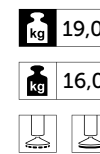
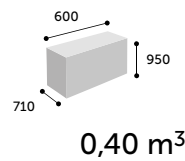
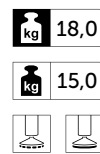
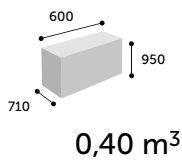
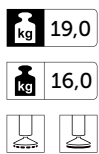

20HST

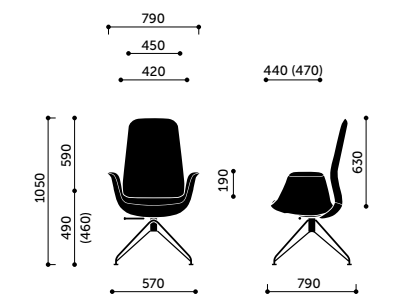

10V3

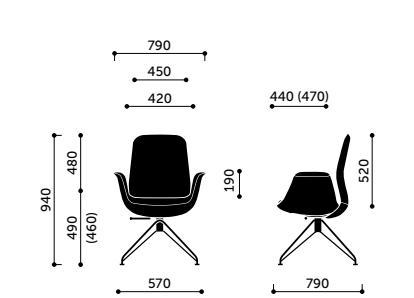

20V3

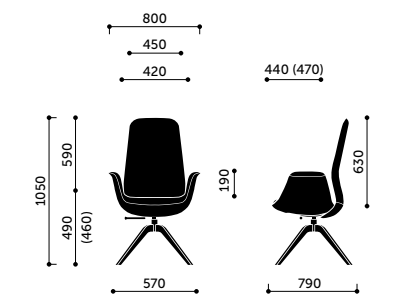
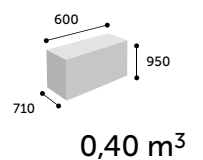
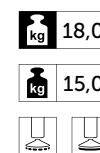
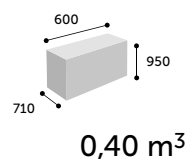
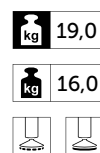
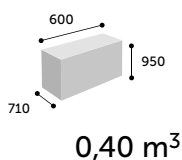
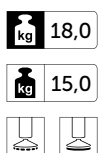

10HW

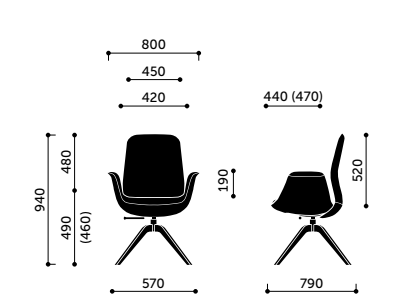

20HW

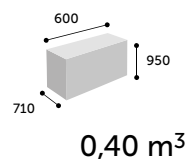
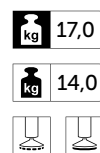
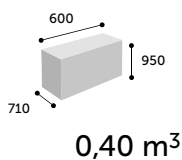
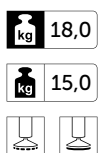

# Eminent

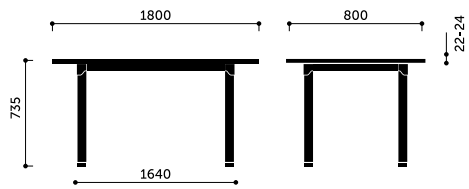

**Eminent 4590-22**

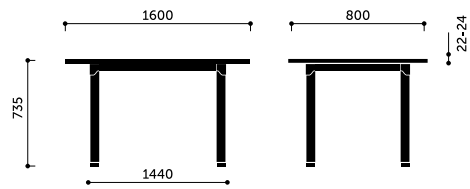

**Eminent 4590-24**

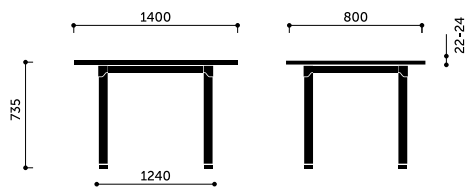

**Eminent 4590-25**

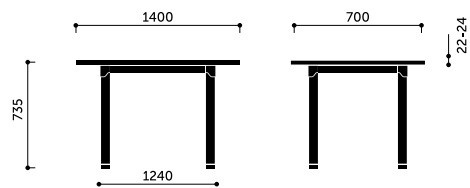

**Eminent 4590-38**

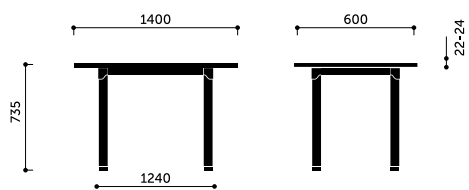

**Eminent 4590-52**

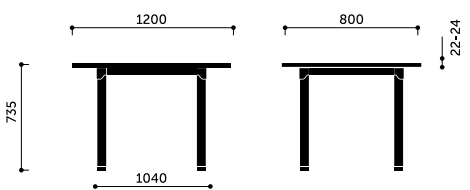

**Eminent 4590-27**

# Technical details

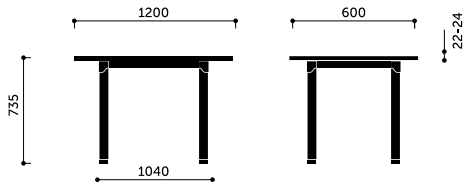

**Eminent 4590-54**

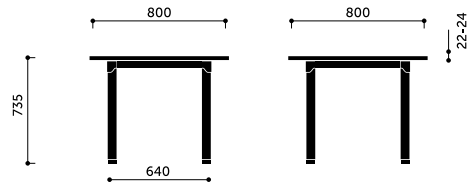

**Eminent 4590-30**

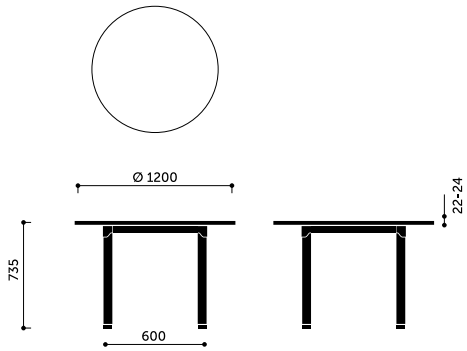

**Eminent 4592-30**

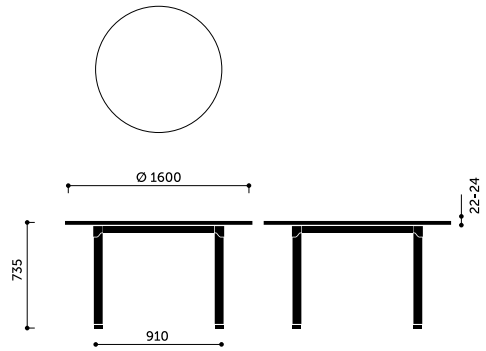

**Eminent 4592-50**

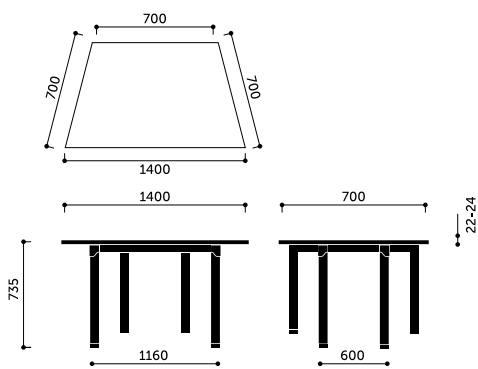

**Eminent 4592-50**

# Fan

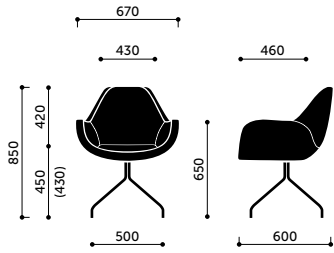

**10H / 10HS**

**kg** 13,5

**kg** 10,5

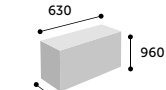

**0,41 m<sup>3</sup>**

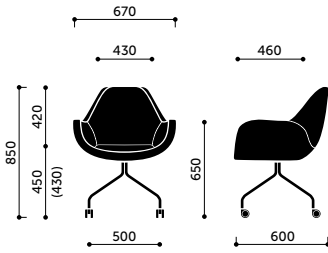

**10HC**

**kg** 13,5

**kg** 10,5

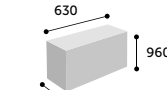

**0,41 m<sup>3</sup>**

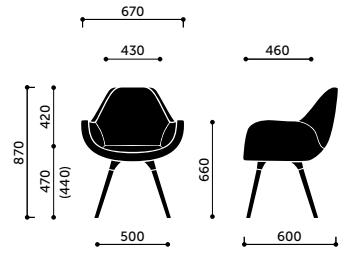

**10HW**

**kg** 12,5

**kg** 9,5

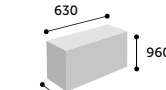

**0,41 m<sup>3</sup>**

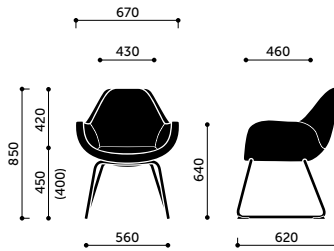

**10V**

**kg** 13,5

**kg** 10,5

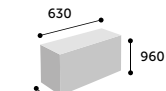

**0,41 m<sup>3</sup>**

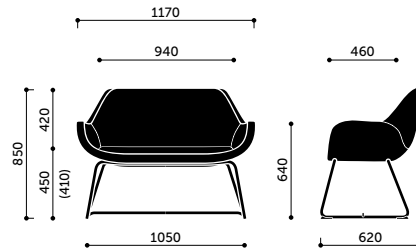

**20V**

**kg** 24,0

**kg** 17,0

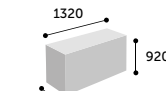

**0,91 m<sup>3</sup>**

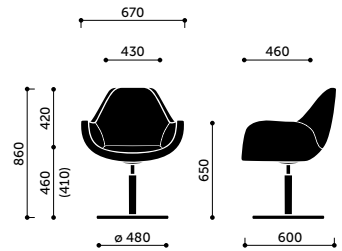

**10R**

**kg** 27,0

**kg** 23,0

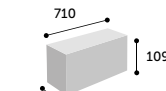

**0,50 m<sup>3</sup>**

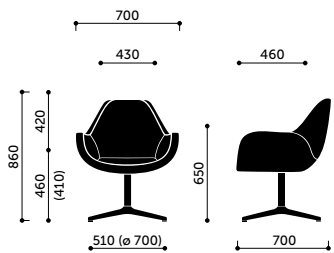

**10F**

**kg** 14,5

**kg** 11,5

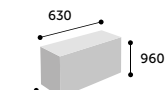

**0,41 m<sup>3</sup>**

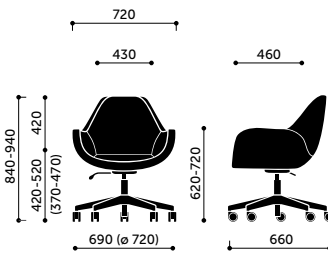

**10Z**

**kg** 16,5

**kg** 12,0

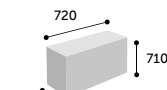

**0,35 m<sup>3</sup>**

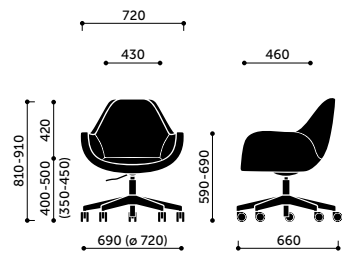

**10E**

**kg** 17,5

**kg** 13,0

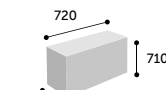

**0,35 m<sup>3</sup>**

# Mickey



# Technical details

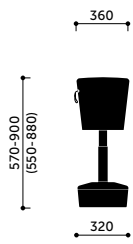

**Mickey**

 13,5

 11,5

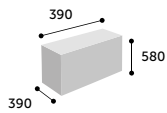

0,09 m<sup>3</sup>

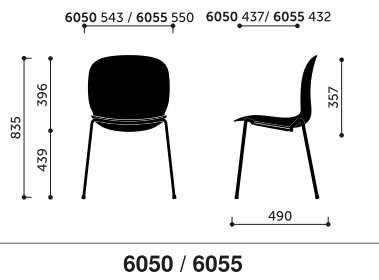

**6050 / 6055**

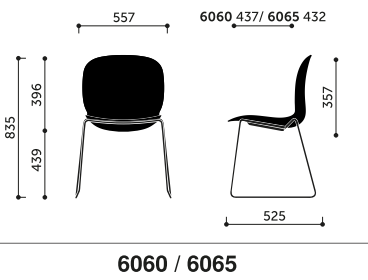

**6060 / 6065**

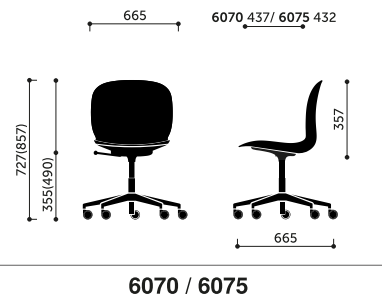

**6070 / 6075**

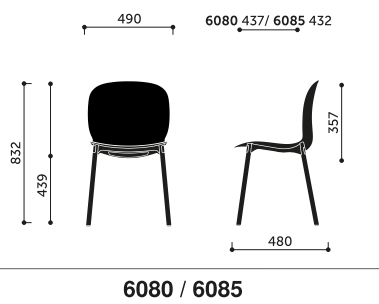

**6080 / 6085**

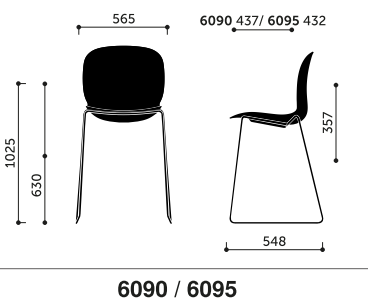

**6090 / 6095**

# Technical details

## Normo

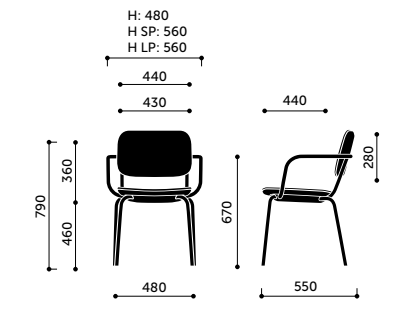

**H / H SP / H LP**

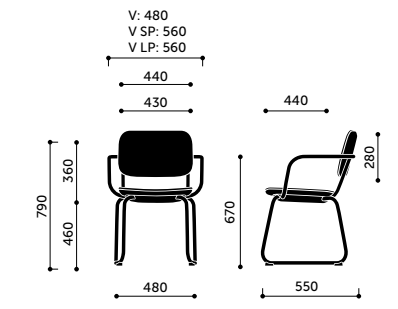
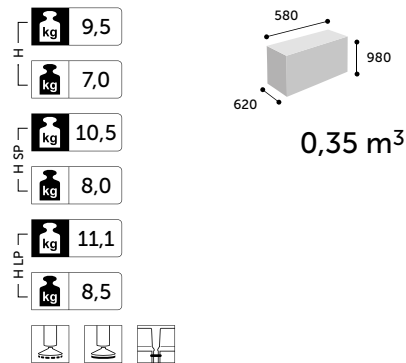

**V / V SP / V LP**

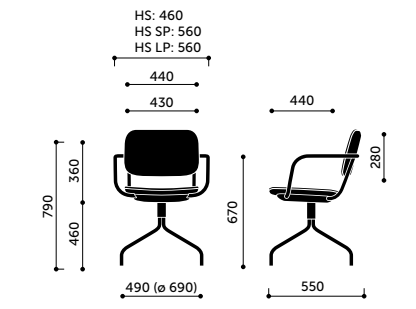
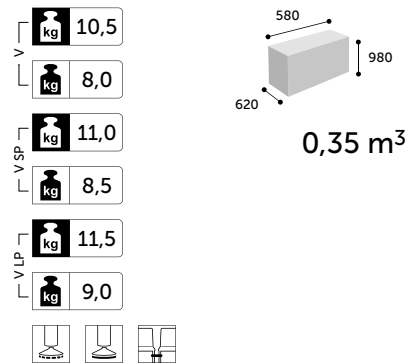

**HS / HS SP / HS LP**

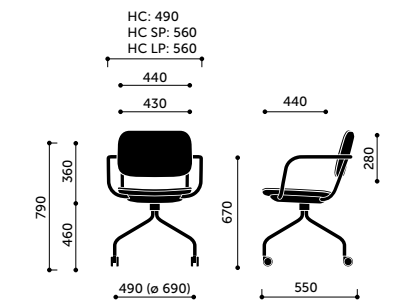
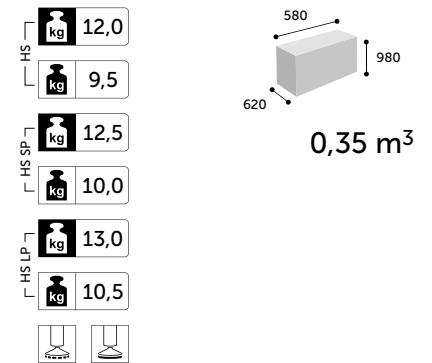

**HC / HC SP / HC LP**

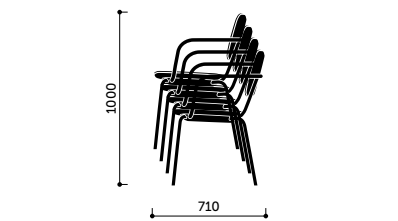
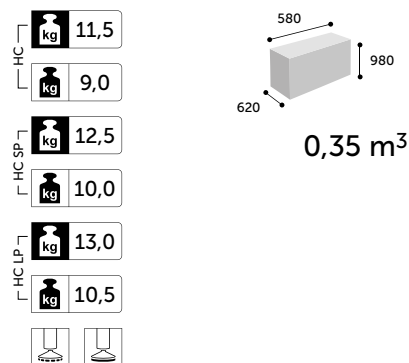

**stacking H / H SP / H LP / V / V SP**



Nu

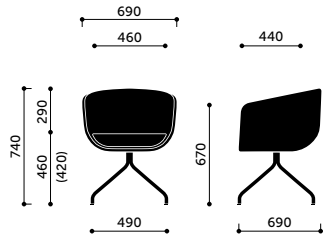

**20HS**

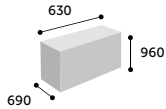
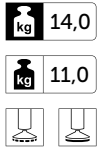

**0,41 m<sup>3</sup>**

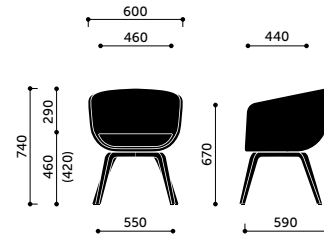

**20HW**

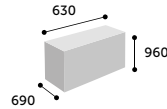
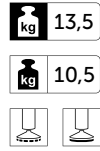

**0,41 m<sup>3</sup>**

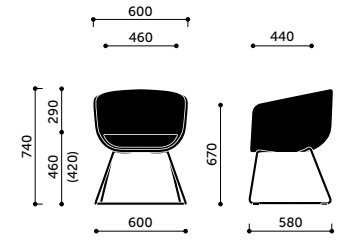

**20V3**

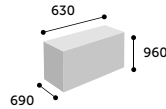
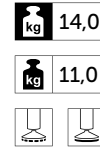

**0,41 m<sup>3</sup>**

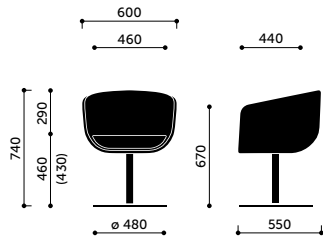

**20R**

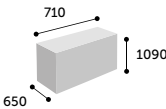
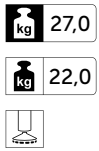

**0,50 m<sup>3</sup>**

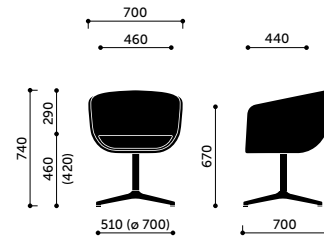

**20F**

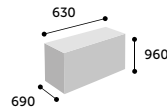
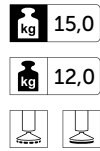

**0,41 m<sup>3</sup>**

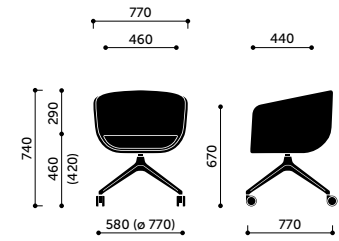

**20HC**

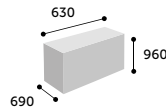
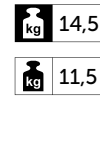

**0,41 m<sup>3</sup>**

# Revo

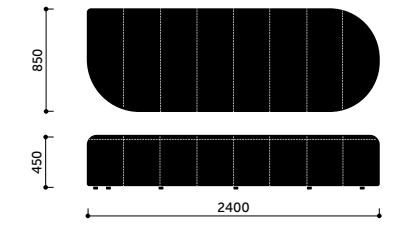

**SW240**

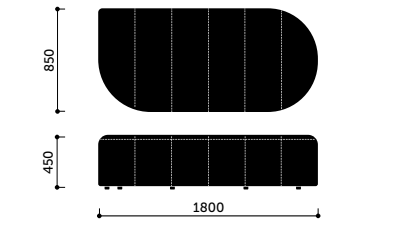

**SW180**

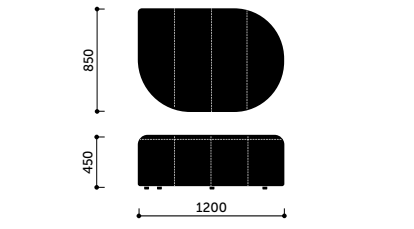

**SW120**

50,5  
 42,0

**1,10 m<sup>3</sup>**

40,5  
 34,0

**0,85 m<sup>3</sup>**

27,0  
 21,0

**0,60 m<sup>3</sup>**

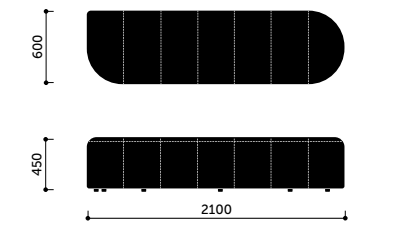

**SN210**

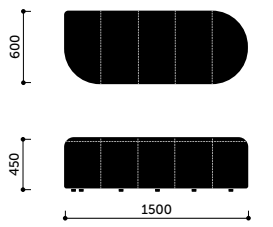

**SN150**

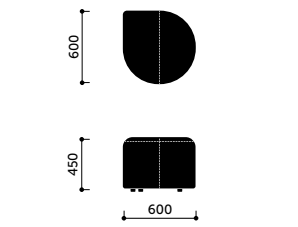

**P60**

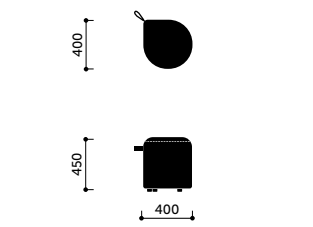

**P40**

34,0  
 27,0

**0,70 m<sup>3</sup>**

23,5  
 19,0

**0,60 m<sup>3</sup>**

8,5  
 6,5

**0,25m<sup>3</sup>**

4,5  
 3,5

**0,12m<sup>3</sup>**

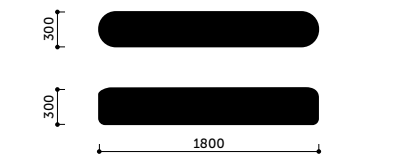

**B180**

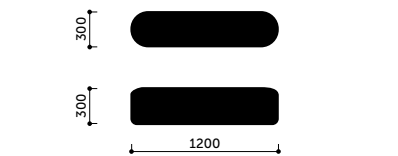

**B120**

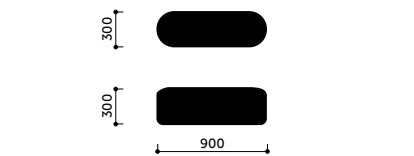

**B90**

14,0  
 10,0

**0,35 m<sup>3</sup>**

11,5  
 8,0

**0,25 m<sup>3</sup>**

8,0  
 5,0

**0,18m<sup>3</sup>**

# Technical details

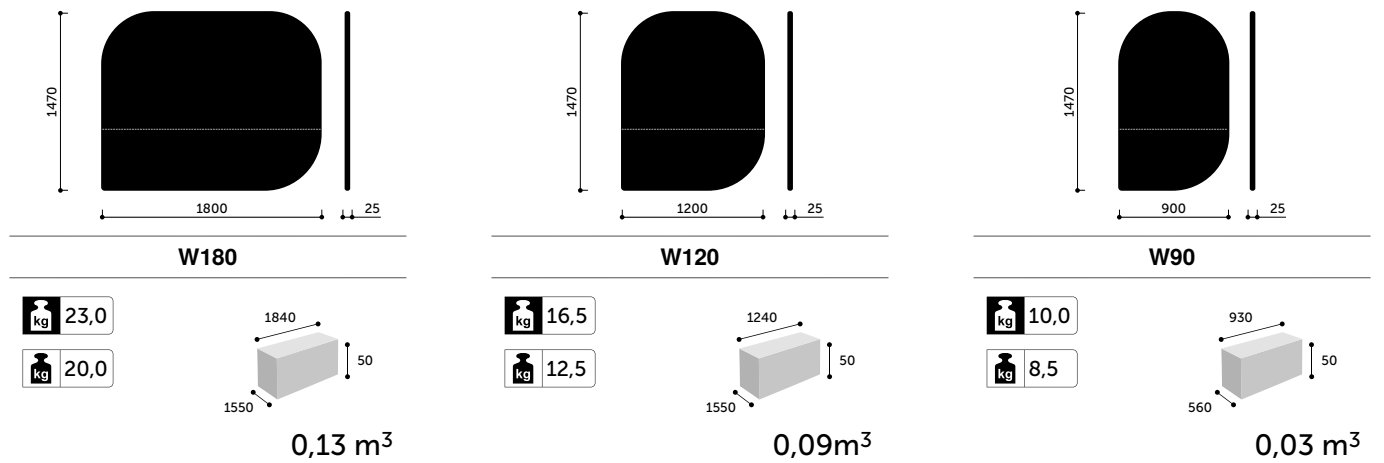

# Revo Tables

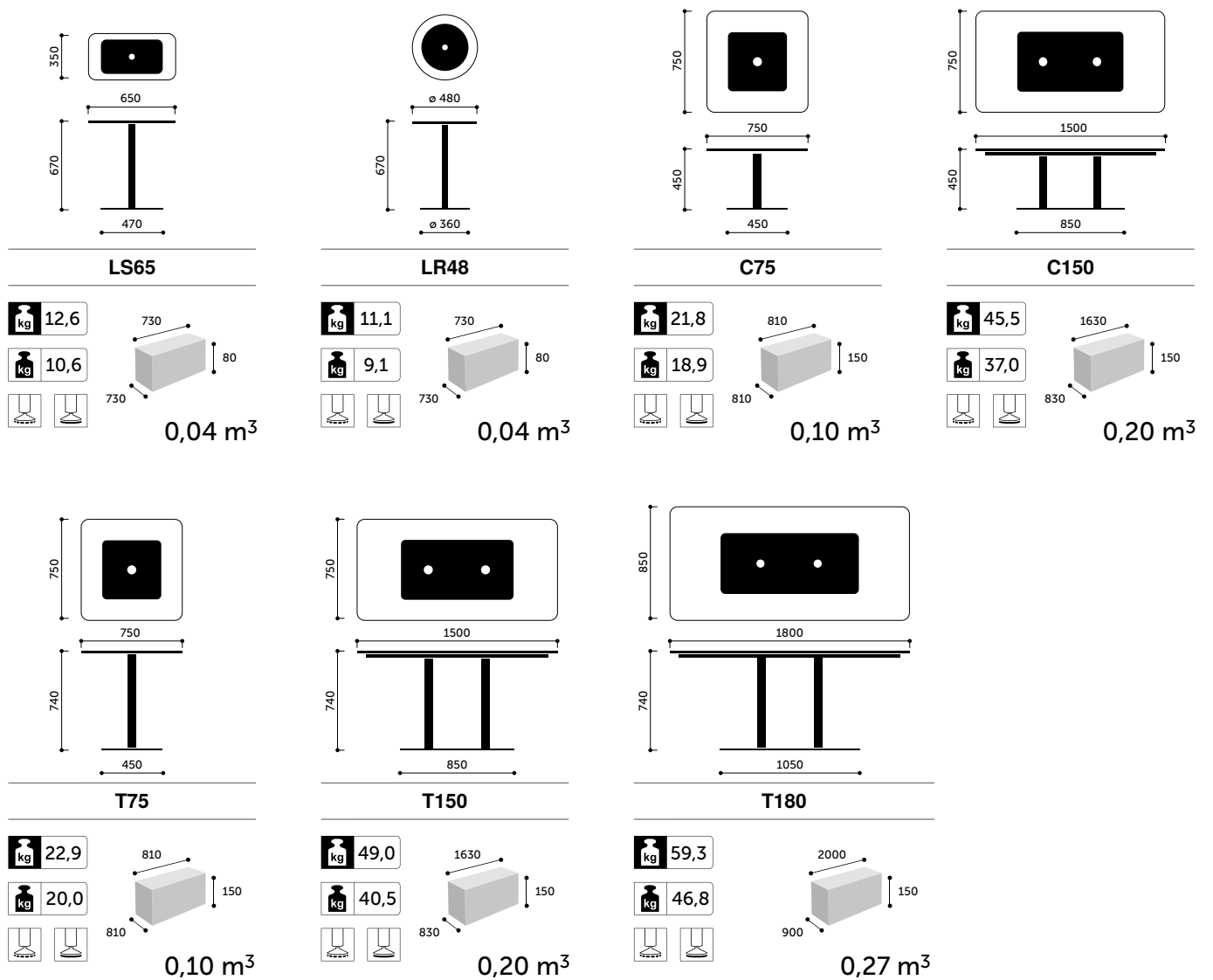

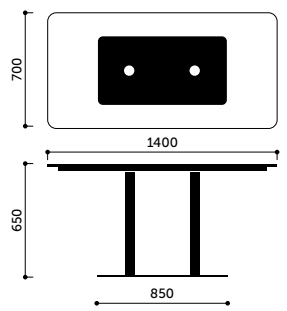

**MT140**

**kg** 47,5

**kg** 39,0

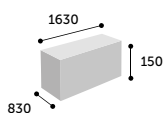

0,20 m<sup>3</sup>

## Seven

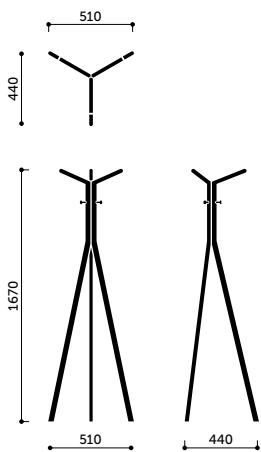

**Seven**

**kg** 6,0

**kg** 5,0

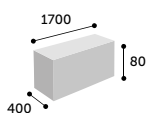

0,05 m<sup>3</sup>

## Sorriso

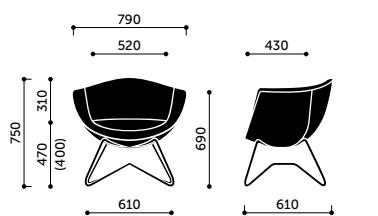

10V

 17,5

 13,5

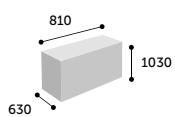

0,53 m<sup>3</sup>



# Technical details

## Standard Folding Table

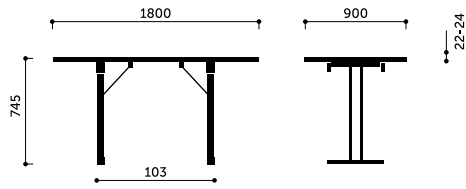

**Standard Folding Table 4680-10**

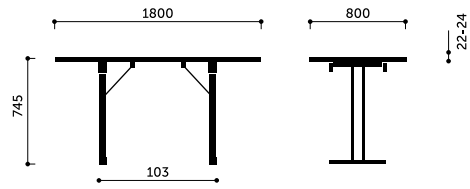

**Standard Folding Table 4680-22**

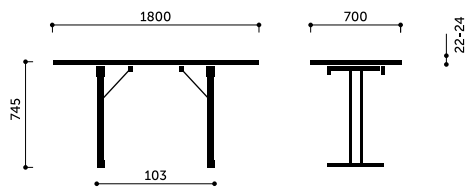

**Standard Folding Table 4680-36**

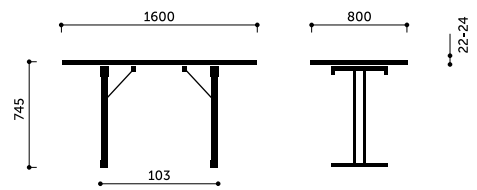

**Standard Folding Table 4680-24**

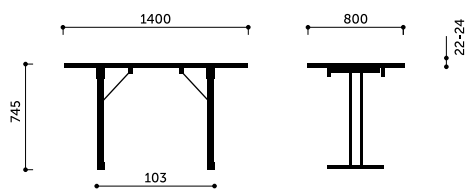

**Standard Folding Table 4680-25**

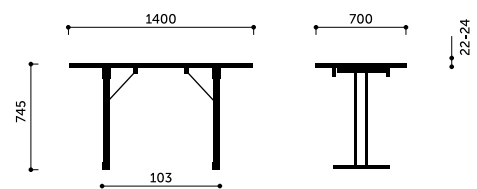

**Standard Folding Table 4680-38**

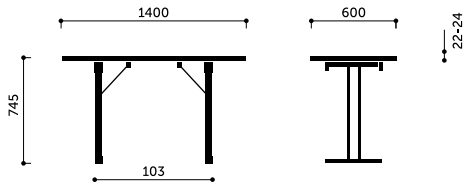

**Standard Folding Table 4680-52**

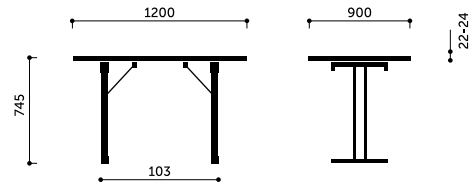

**Standard Folding Table 4680-15**

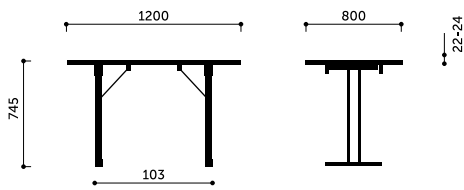

**Standard Folding Table 4680-27**

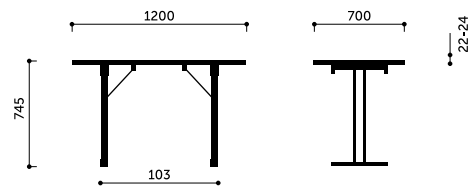

**Standard Folding Table 4680-39**

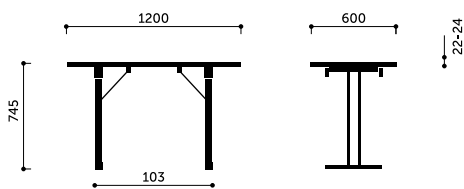

**Standard Folding Table 4680-54**

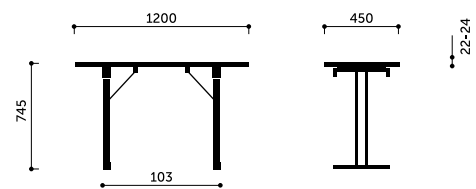

**Standard Folding Table 4680-90**

# Technical details

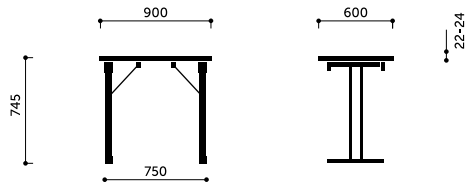

**Standard Folding Table 4680-58**

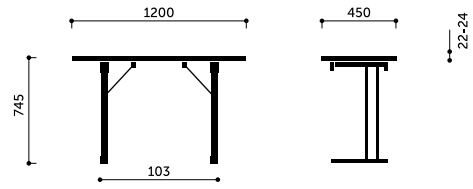

**Standard Folding Table 4688-90**

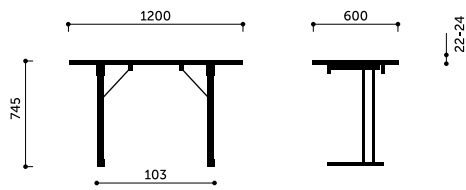

**Standard Folding Table 4688-54**

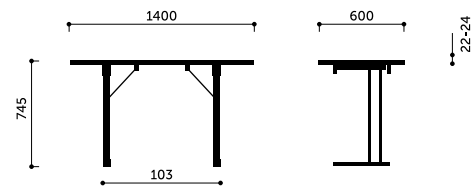

**Standard Folding Table 4688-52**

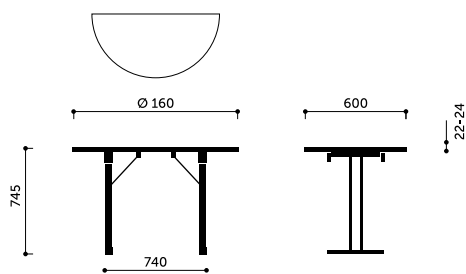

**Standard Folding Table 4681-45**

# Technical details

## Trillo<sup>Pro</sup>

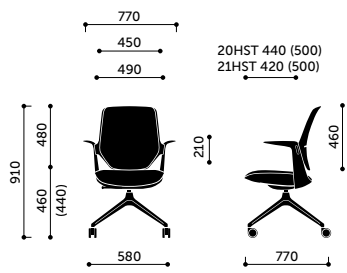

20HST/21HST

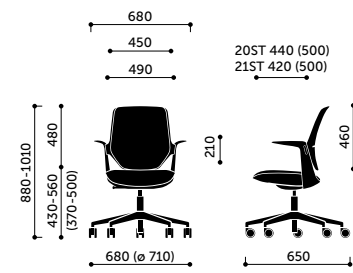

20ST/21ST

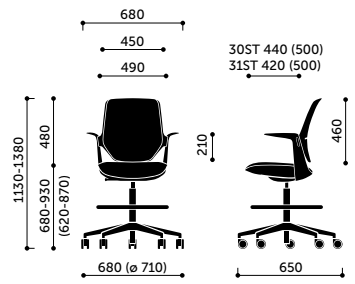

30ST/31ST

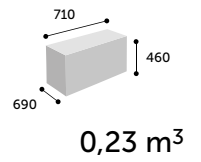
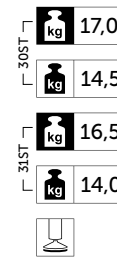
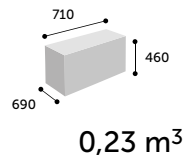
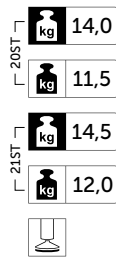
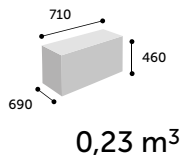
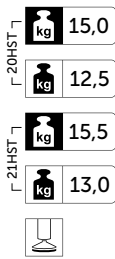

# Trillo<sup>Pro</sup>

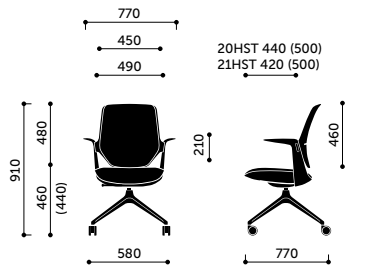

**20HST/21HST**

- 20HST 15,0 kg
- 20HST 12,5 kg
- 21HST 15,5 kg
- 21HST 13,0 kg

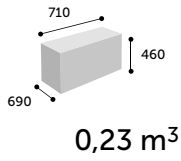

# u-Connect

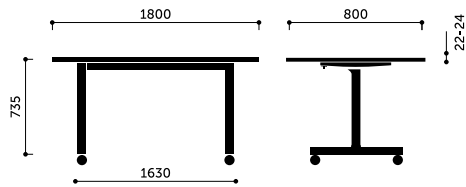

**u-Connect 3490-22**

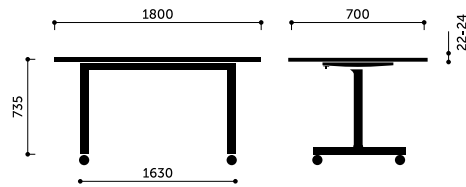

**u-Connect 3490-36**

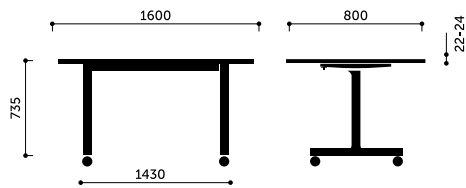

**u-Connect 3490-24**

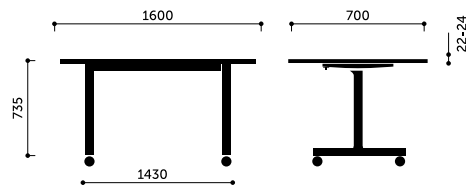

**u-Connect 3490-37**

# Technical details

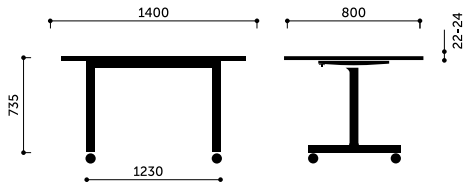

**u-Connect 3490-25**

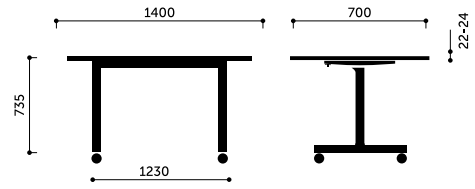

**u-Connect 3490-38**

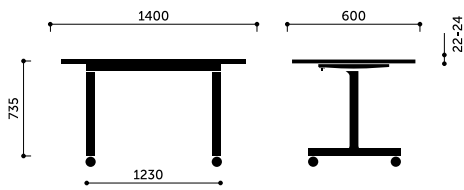

**u-Connect 3490-52**

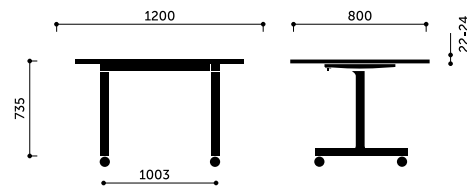

**u-Connect 3490-27**

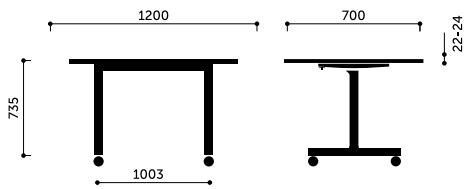

**u-Connect 3490-39**

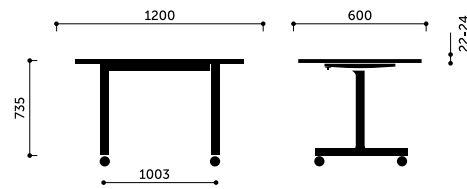

**u-Connect 3490-54**

# Vancouver Lite

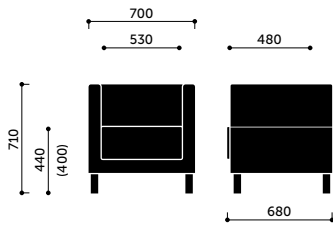

VL1 H / VL1 V

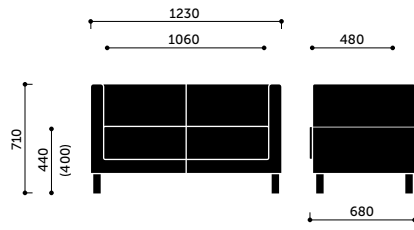

VL2 H / VL2 V

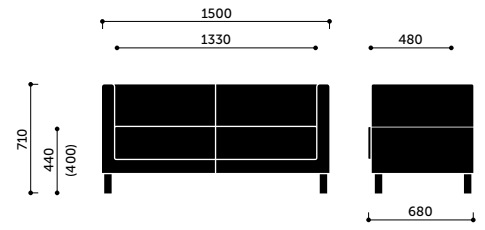

VL2,5 H / VL2,5 V

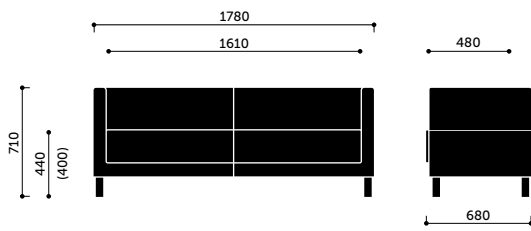
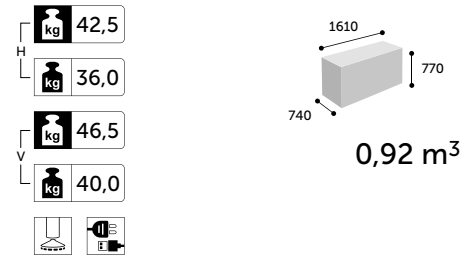
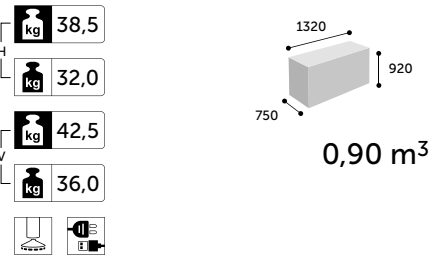
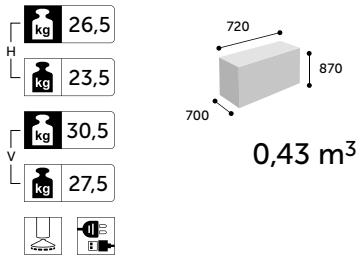

VL3 H / VL3 V

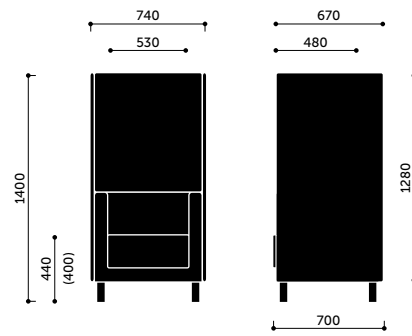

VL1 HW / VL1 VW + VL W1

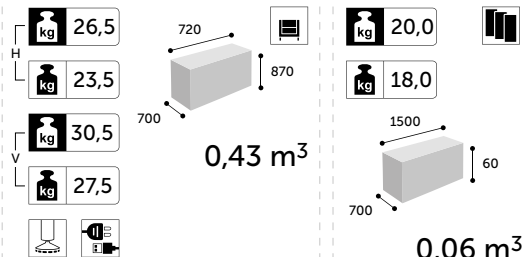
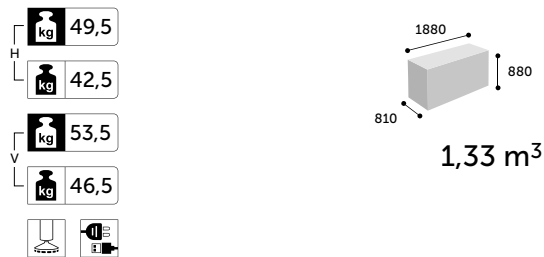

# Technical details

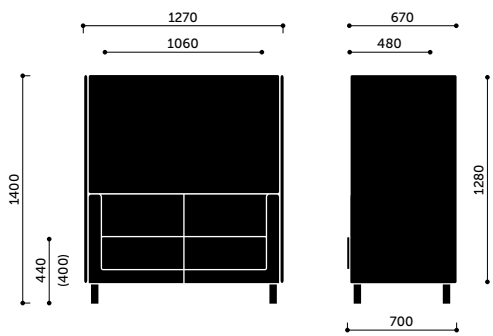

**VL2 HW / VL2 VW + VL W2**

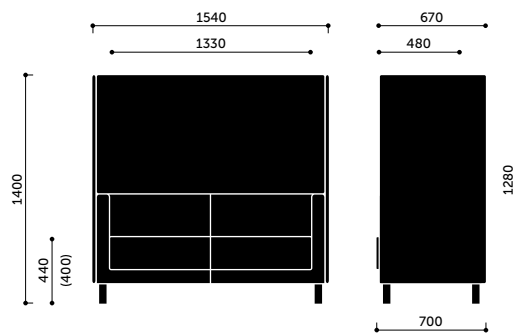

**VL2,5 HW / VL2,5 VW + VL W2,5**

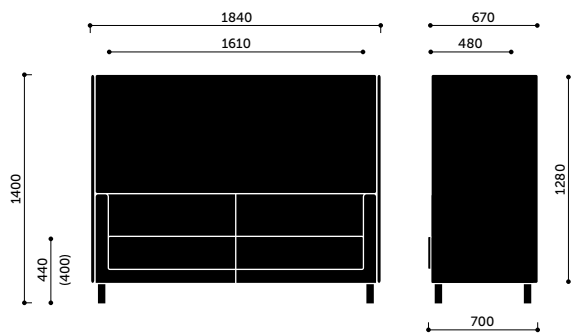
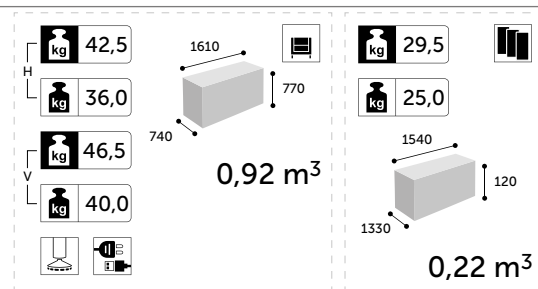
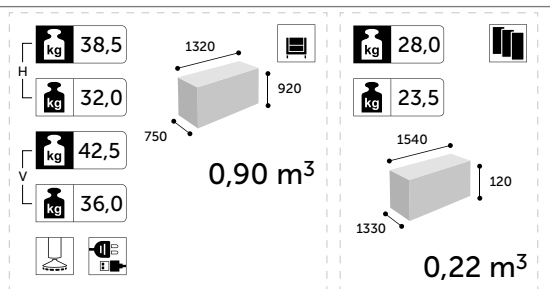

**VL3 HW / VL3 VW + VL W3**

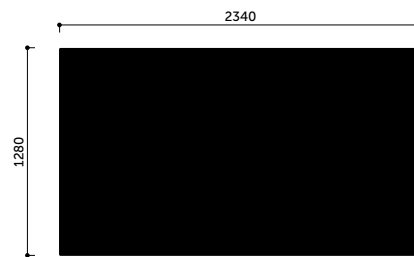

**VL SW / VL SW HA**

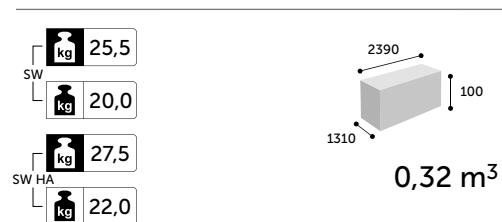
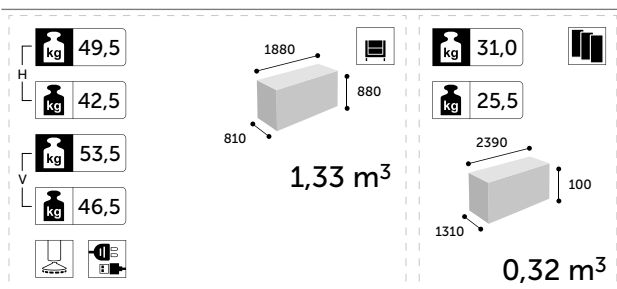



## Vancouver Oto

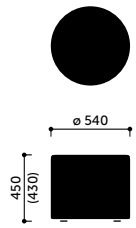

VOR1

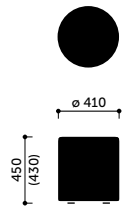
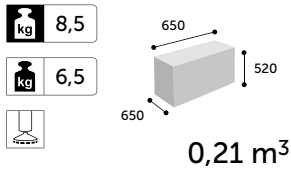

VOR2

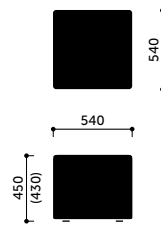
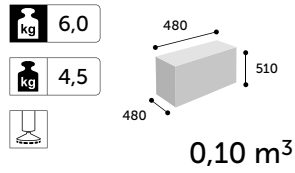

VOS1

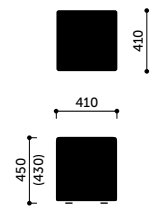
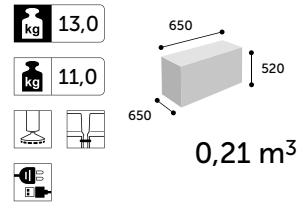

VOS2

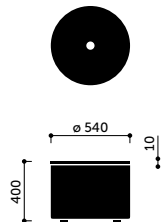
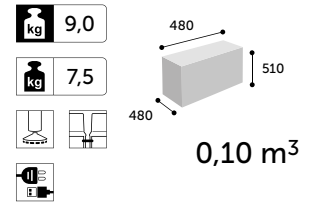

VOR1B

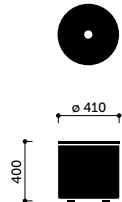
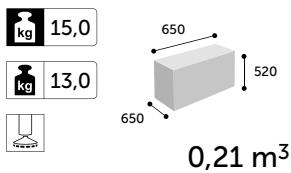

VOR2B

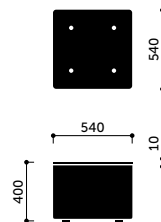
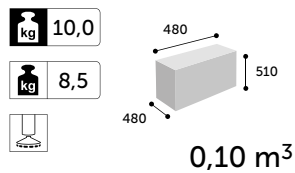

VOS1B

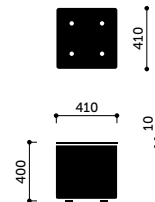
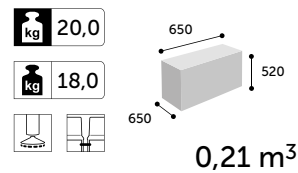

VOS2B

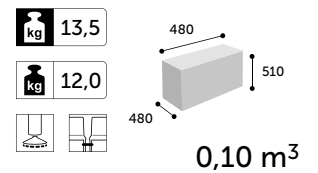

## Wall In

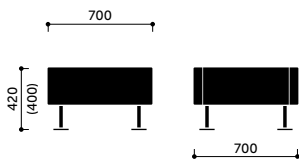

10 / 11 / 12 / 13

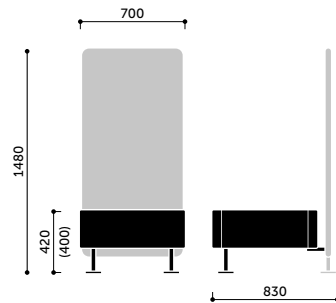
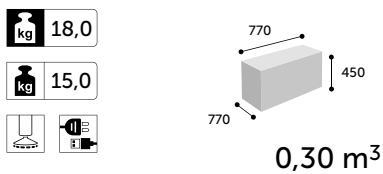

11 + W11

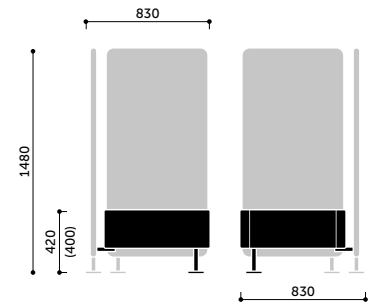

12 + 2xW11 (version I)

# Technical details

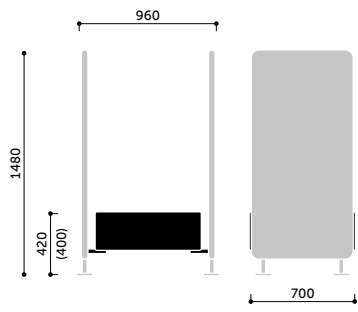

**12 + 2xW11 (version II)**

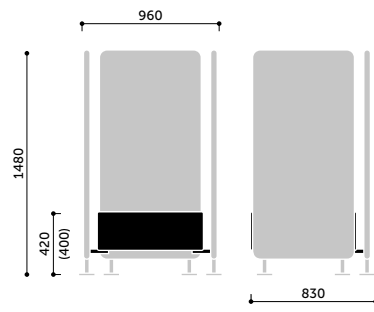

**13 + 3xW11**

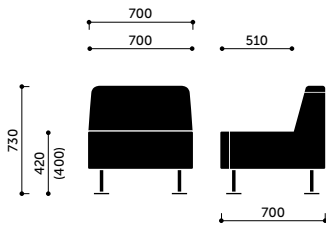

**20 / 21 / 22 / 23**

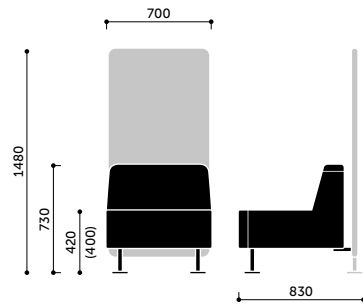

**21 + W11**

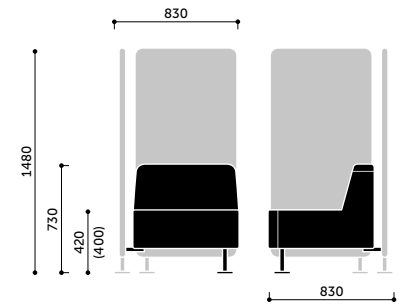

**22 + 2xW11 (version I)**

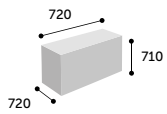
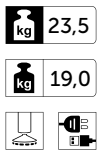

**0,35 m<sup>3</sup>**

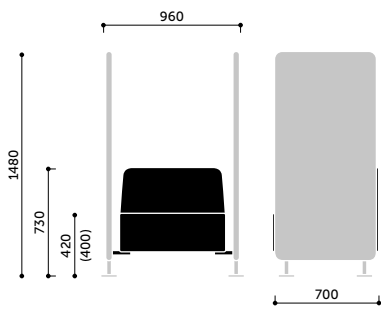

**22 + 2xW11 (version II)**

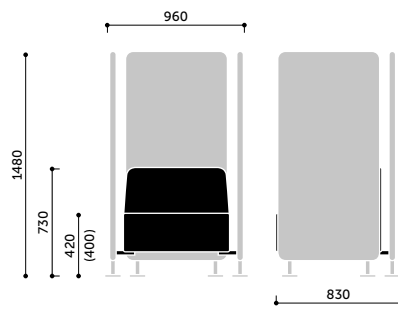

**23 + 3xW11**

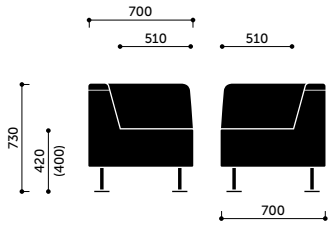

**30 / 31 / 32**

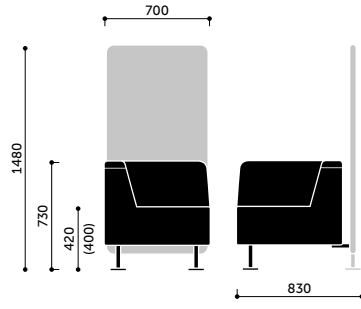

**31**

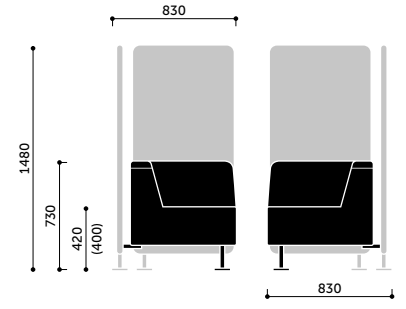

**32**

**kg** 24,5

**kg** 20,0

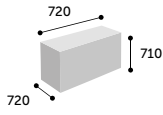

0,35 m<sup>3</sup>

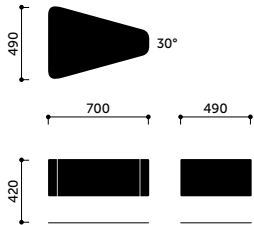

**C1**

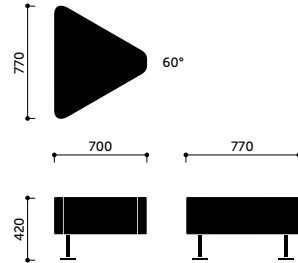

**C2**

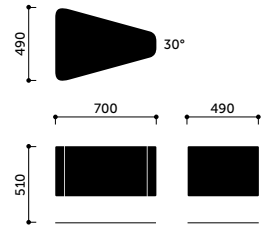

**P1**

**kg** 8,5

**kg** 7,0

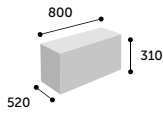

0,13 m<sup>3</sup>

**kg** 11,5

**kg** 9,0

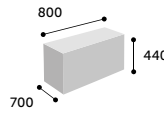

0,25 m<sup>3</sup>

**kg** 12,0

**kg** 9,5

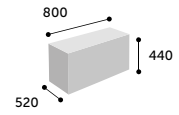

0,20 m<sup>3</sup>

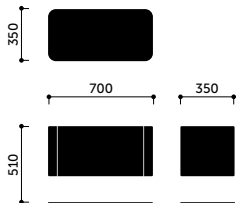

**P3**

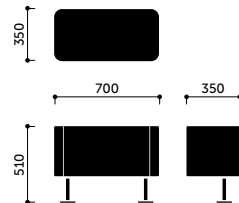

**P4**

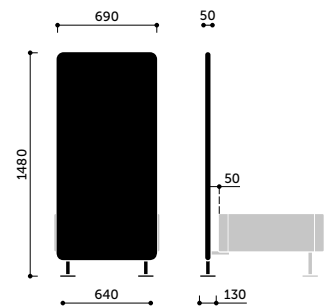

**W11 / W12**

**kg** 12,5

**kg** 10,0

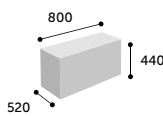

0,20 m<sup>3</sup>

**kg** 13,5

**kg** 11,0

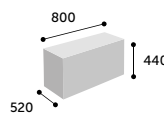

0,20 m<sup>3</sup>

**kg** 11,5

**kg** 9,5

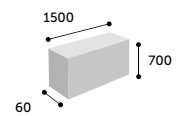
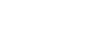

0,06 m<sup>3</sup>

# Technical details

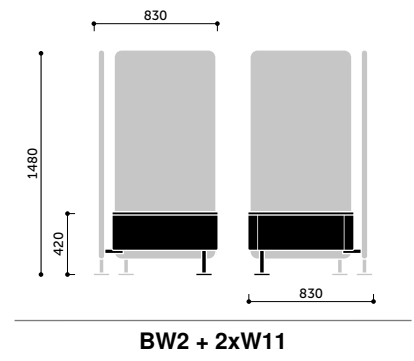
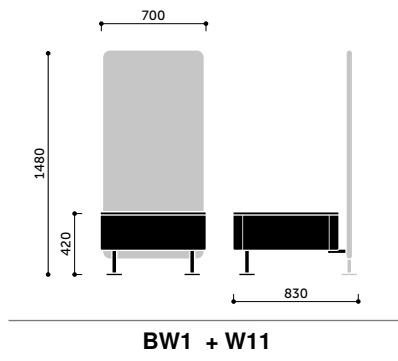
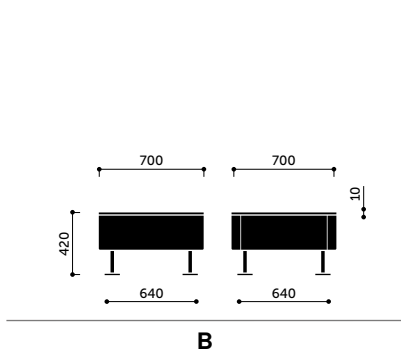

- 28,5
- 25,5
- 

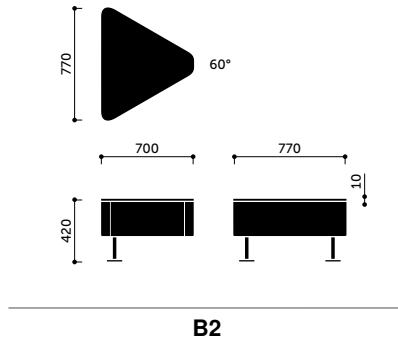
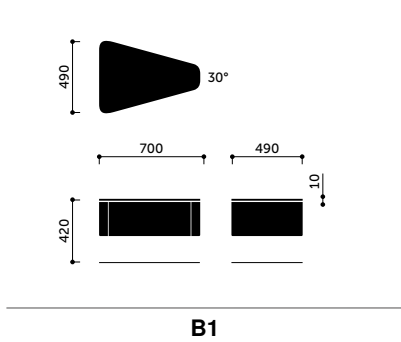
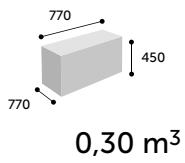

- 14,5
- 13,0
- 

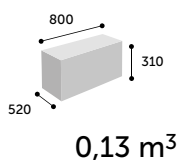

- 20,5
- 18,0
- 

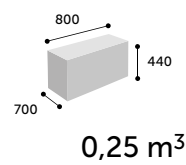

# Zoo

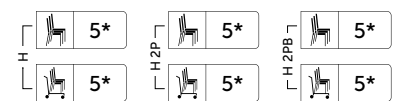
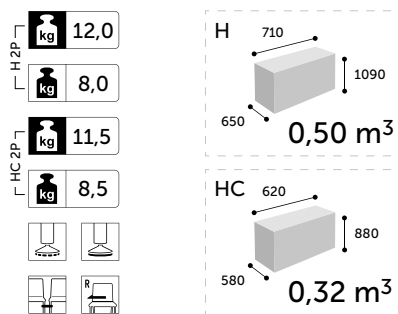
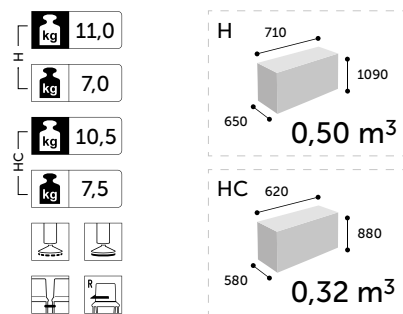
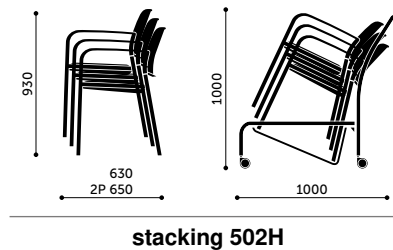
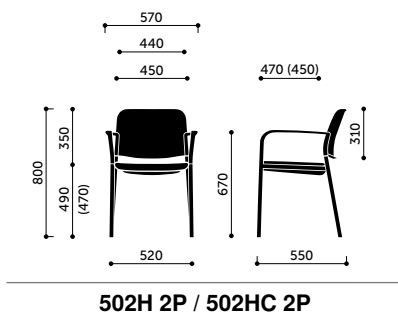
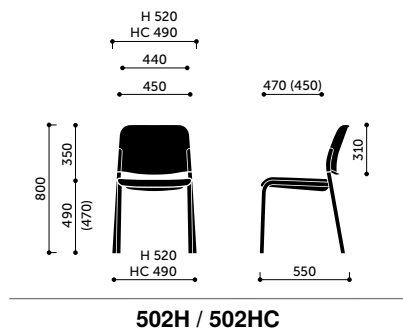
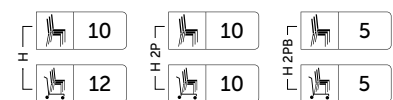
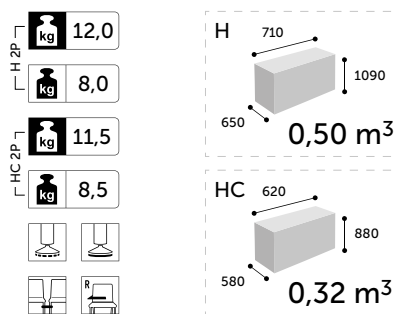
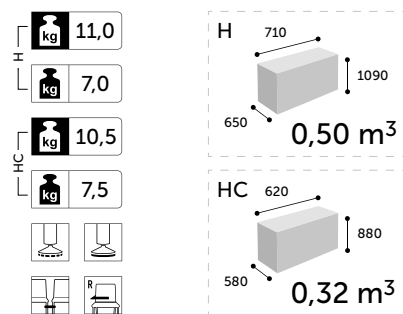
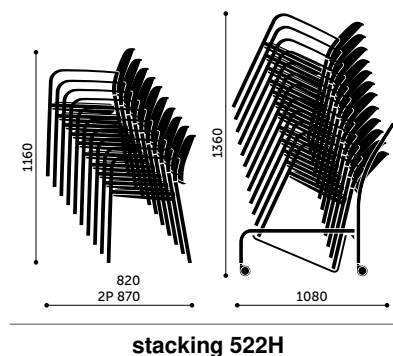
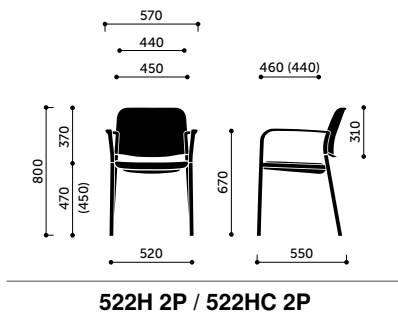
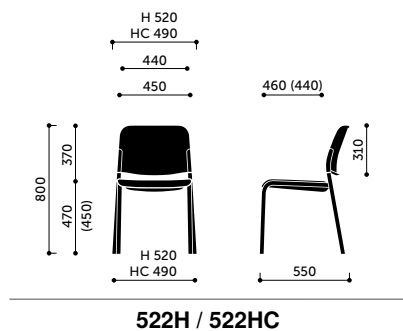

\* chairs upholstered in Valencia: 3 pcs.

# Technical details

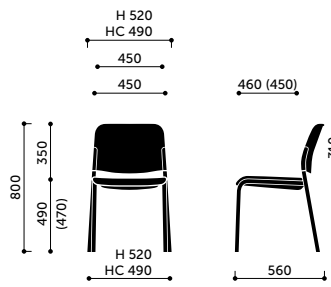

**500H / 500HC**

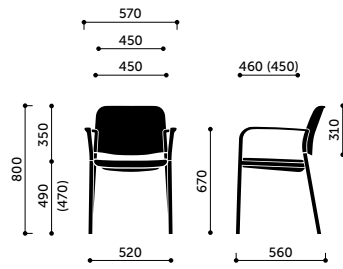

**500H 2P / 500HC 2P**

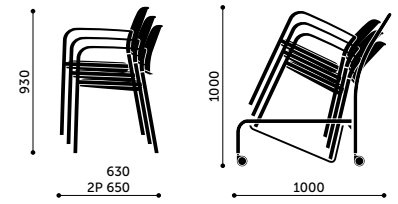

**stacking 500H**

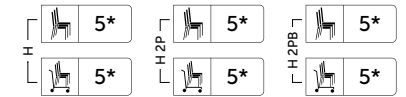
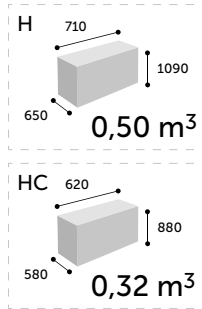
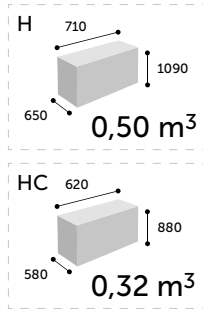
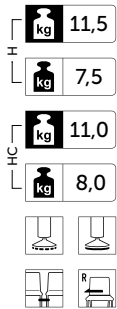

\* chairs upholstered in Valencia: 3 pcs.

# Castors / glides

| Castors / glides  | Models   | Type                     | Castors / glides  | Models   | Type                |
|---|--|--------------------------|---|--|---------------------|
|    | Ellie <sup>Pro</sup> , Noor, Trillo <sup>Pro</sup> | soft / hard<br>(ø 65 mm) |    | Com V  | felt / teflon       |
|    | Trillo <sup>Pro</sup> 30ST/31ST                    | soft / hard<br>(ø 65 mm) |    | Chic H   | felt / teflon       |
|    | Acos <sup>Pro</sup> 30VN                           | felt / teflon            |    | Chic 20F, Fan 10F, Nu 20F  | felt / teflon       |
|    | Acos <sup>Pro</sup> 30H                            | felt / teflon            |    | Chic 20HW, Nu 20HW   | felt / teflon       |
|   | Ariz - without armrests                            | felt / teflon            |   | Ellie <sup>Pro</sup> 10HW, Ellie <sup>Pro</sup> 20HW   | felt / teflon       |
|  | Ariz - with armrests                               | felt / teflon            |  | Chic Lounge V3, Nu 20V3  | felt / teflon       |
|  | Bit H  | felt / teflon            |  | Ellie <sup>Pro</sup> 10V3, Ellie <sup>Pro</sup> 20V3   | felt / teflon       |
|  | Bit V, Zoo H                                       | felt / teflon            |  | Ellie <sup>Pro</sup> 10ST, Ellie <sup>Pro</sup> 20ST,<br>Ellie <sup>Pro</sup> 10HST, Ellie <sup>Pro</sup> 20HST,<br>Trillo <sup>Pro</sup> 20, Trillo <sup>Pro</sup> 21,<br>Nu HC | teflon<br>(ø 50 mm) |
|  | Com H  | felt / teflon            |  | Fan 10H, Fan 10HS,<br>Nu 20HS  | felt / teflon       |
|  | Com V1   | felt / teflon            |  | Fan 10HW   | felt / teflon       |
|  | Com V2   | felt / teflon            |  | Fan 10V, Fan 20V   | felt / teflon       |
|  | Ana  | felt / hard              |   |  |                     |









## Castors / glides

| Castors / glides  | Models                                    | Type                   |
|---|---|------------------------|
|    | Fan 10HC,<br>Fan 10Z, Fan 10E,<br>Nu 20HC | Universal<br>(ø 65 mm) |
|    | Com HC, Normo HC                          | Universal<br>(ø 55 mm) |
|    | Fan 10Z, Fan 10E                          | teflon                 |
|    | Sorriso 10V                               | felt / teflon          |
|   | Noor 6090/6095                            | felt / hard            |
|  | Noor 6060/6065                            | felt / hard            |
|  | Noor 6050/6055                            | felt / hard            |
|  | Noor 6080/6085                            | felt / hard            |





Castors are equipped with a brake that prevents the chair from "moving away" without a load.  
In models LightUp 330ST/350ST and Trillo<sup>®</sup> 30ST/31ST castors are equipped with a reverse brake that prevents the chair from "moving away" with a load.



# Bases

| Base  | Applied to the models   | Colour            | Type of material                 | Diameter (mm) |
|---|---|-------------------|----------------------------------|---------------|
|    | Ellie <sup>Pro</sup> 10HST, Ellie <sup>Pro</sup> 20HST, Trillo <sup>Pro</sup> 20HST, Trillo <sup>Pro</sup> 21HST, Nu HC | black             | aluminium powder coated aluminum | 770           |
|    | Ellie <sup>Pro</sup> 10HST, Ellie <sup>Pro</sup> 20HST, Trillo <sup>Pro</sup> 20HST, Trillo <sup>Pro</sup> 21HST, Nu HC | white             | powder coated aluminum           | 770           |
|    | Ellie <sup>Pro</sup> 10HST, Ellie <sup>Pro</sup> 20HST, Trillo <sup>Pro</sup> 20HST, Trillo <sup>Pro</sup> 21HST, Nu HC | graphite          | powder coated aluminum           | 770           |
|   | Ellie <sup>Pro</sup> 10HST, Ellie <sup>Pro</sup> 20HST, Trillo <sup>Pro</sup> 20HST, Trillo <sup>Pro</sup> 21HST, Nu HC | polished aluminum | aluminium                        | 770           |
|  | Ellie <sup>Pro</sup> 10ST, Ellie <sup>Pro</sup> 20ST  | black             | plastic - polyamide              | 710           |
|  | Ellie <sup>Pro</sup> 10ST, Ellie <sup>Pro</sup> 20ST  | light grey        | plastic - polyamide              | 710           |
|  | Noor 6070, Noor 6075  | polished aluminum | aluminium                        | 665           |
|  | Noor 6070, Noor 6075  | black             | aluminium                        | 665           |
|  | Noor 6070, Noor 6075  | white             | aluminum                         | 665           |

# Bases

| Base  | Applied to the models | Colour            | Type of material       | Diameter (mm) |
|---|-----------------------|-------------------|------------------------|---------------|
|    | Fan                   | black             | plastic - polyamide    | 720           |
|    | Fan                   | MetallicPro       | powder coated aluminum | 720           |
|    | Fan                   | polished aluminum | aluminum               | 720           |
|   | Sorriso 10F           | polished aluminum | aluminium              | 760           |
|  | Fan 10F, Nu 20F       | polished aluminum | aluminium              | 700           |

# Mechanisms



## Rocker

Fan 10Z

A - Seat height  
B - Tilt angle of the backrest and the seat



## Economic

Fan 10E

A - Seat height



## Economic

Noor 6070/6075

A - Seat height



## Synchro Self\*

Trillo<sup>Pro</sup>, Ellie<sup>Pro</sup>

A - Seat height  
B - Tilt angle of the backrest and the seat



## Synchro Self\*

Trillo<sup>Pro</sup>, Ellie<sup>Pro</sup>

A - Tilt angle of the backrest and the seat



## Rocker

MyTurn 10FZ, 20FZ

A - Seat height (only in Z models)  
B - Tilt angle of the backrest and the seat

The Synchro mechanisms used in Profim products are equipped with Anti-Shock system after releasing the mechanism, the back does not hit the sitting person, but remains in the previous position. The Synchro mechanism is activated only when the person leans on the backrest again.

# Linking parts

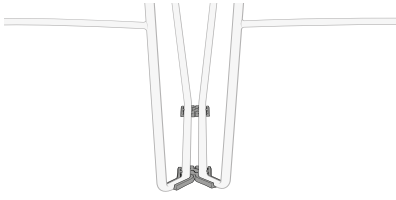

## Linking part Ariz

Price - no extra charge.

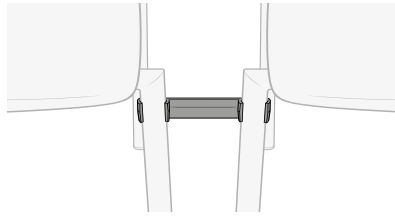

## Universal FIXED 1 Linking part

Available in models without armrests: Bit.

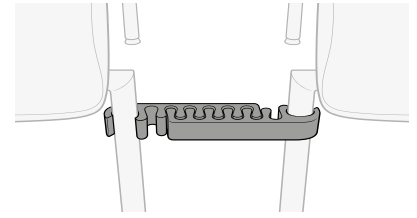

## Universal ADJUSTABLE Linking part

Available in Bit without armrests.  
Available in Com.

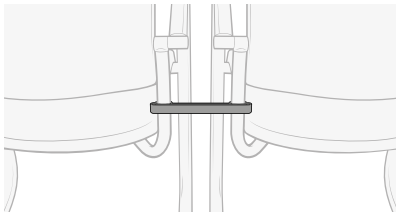

## Universal FIXED 2 Linking part

Available in models: Acos<sup>PRO</sup>.

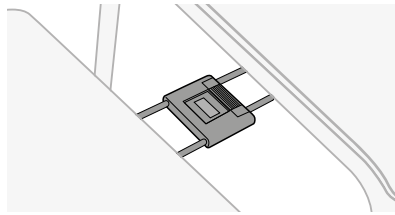

## Linking part Com, Zoo

Available in 4-legged Com and Zoo.

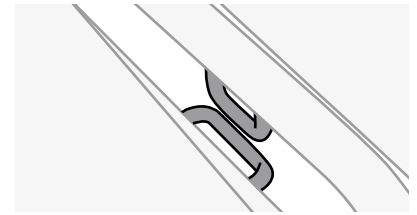

## Linking part Ana

Available in Ana.

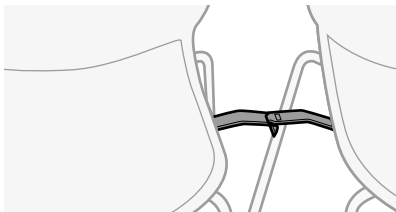

## Linking part Noor

Available in Noor.

# Stacking

|                           | Maximum quantity<br>in stack (pc.) | Maximum quantity<br>in stack on trolley (pc.) |
|---------------------------|------------------------------------|---|
| <b>Acos<sup>Pro</sup></b> |                                    |   |
| 30V                       | 2                                  | -   |
| <b>Ana</b>                |                                    |   |
| 4340                      | 12                                 | -   |
| 4340S                     | 10                                 | -   |
| 4340SR                    | 7                                  | -   |
| <b>Ariz</b>               |                                    |   |
| 550V, 555V                | 15                                 | 45  |
| 550V 2P, 555V 2P          | 10                                 | 45  |
| 560V, 560V 2P             | 5                                  | 20  |
| 570V, 570V 2P             | 5                                  | 20  |
| 575V, 575V 2P             | 5                                  | 20  |
| 550CV                     | 2                                  | -   |
| 555CV                     | 2                                  | -   |
| 560CV                     | 2                                  | -   |
| 570CV                     | 2                                  | -   |
| 575CV                     | 2                                  | -   |
| <b>Bit</b>                |                                    |   |
| 550H, 550H 2P             | 5                                  | -   |
| 555H, 555H 2P             | 5                                  | -   |
| 560H, 560H 2P             | 3                                  | -   |
| 570H, 570H 2P             | 3                                  | -   |
| 575H, 575H 2P             | 3                                  | -   |
| 550V, 550V 2P             | 3                                  | -   |
| 555V, 555V 2P             | 3                                  | -   |
| 560V, 560V 2P             | 3                                  | -   |
| 570V, 570V 2P             | 3                                  | -   |
| 575V, 575V 2P             | 3                                  | -   |
| <b>Com</b>                |                                    |   |
| 12H (+2P)                 | 15                                 | 15  |
| 12H 2PB                   | 5                                  | 5   |
| 12V1 (+2P)                | 5                                  | 5   |
| 12V2                      | 5                                  | 5   |
| 12V                       | 15                                 | 15  |
| 22H (+2P)                 | 12                                 | 12  |
| 22H 2PB                   | 5                                  | 5   |
| 22V1 (+2P)                | 5                                  | 5   |
| 22V2                      | 5                                  | 5   |
| 22V                       | 12                                 | 12  |
| 32H (+2P)                 | 12                                 | 12  |
| 32H 2PB                   | 5                                  | 5   |

|                               | Maximum quantity<br>in stack (pc.) | Maximum quantity<br>in stack on trolley (pc.) |
|-------------------------------|------------------------------------|---|
| 32V1 (+2P)                    | 5                                  | 5   |
| 32V2                          | 5                                  | 5   |
| 32V                           | 12                                 | 12  |
| 42H (+2P)                     | 10                                 | 10  |
| 42H 2PB                       | 5                                  | 5   |
| 42V1 (+2P)                    | 5                                  | 5   |
| 42V2                          | 5                                  | 5   |
| 42V                           | 10                                 | 10  |
| <b>Noor</b>                   |                                    |   |
| 4-leg 6050/6055               | 10                                 | -   |
| 4-leg 6050/6055 with armrests | 10                                 | -   |
| 4-leg 6060/6065               | 5                                  | -   |
| 4-leg 6060/6065 with armrests | 5                                  | -   |
| <b>Normo</b>                  |                                    |   |
| H, H LP, H SP                 | 4                                  | -   |
| V, V SP                       | 4                                  | -   |
| <b>Zoo</b>                    |                                    |   |
| 522H                          | 10                                 | 12  |
| 522H 2P                       | 10                                 | 10  |
| 522H 2PB                      | 5                                  | 5   |
| 502H, 502H 2P, 502H 2PB       | 5*                                 | 5*  |
| 500H, 500H 2P, 500H 2PB       | 5*                                 | 5*  |

\* Chairs upholstered in Valencia - 3 pcs.

## Glides, table tops, joining in rows

|                       | Joining<br>in rows | Felt glides<br>(for hard surfaces) | Teflon glides<br>(universal) | Left-sided<br>table top | Right-sided<br>table top |
|-----------------------|--------------------|------------------------------------|------------------------------|-------------------------|--------------------------|
| Ana                   | •                  | •                                  |                              | •                       | •                        |
| Ariz                  | •                  | •                                  | •                            | •                       | •                        |
| Bit                   | •                  | •                                  | •                            |                         |                          |
| Chic                  |                    | •                                  | •                            |                         |                          |
| Chic Lounge           |                    | •                                  | •                            |                         |                          |
| Chic Tables           |                    | •                                  | •                            |                         |                          |
| Com                   | •                  | •                                  | •                            | •                       |                          |
| Ellie <sup>Pro</sup>  |                    | •                                  | •                            |                         |                          |
| Fan                   |                    | •                                  | •                            |                         |                          |
| Mickey                |                    |                                    | •                            |                         |                          |
| MyTurn Sofa           |                    | •                                  |                              |                         |                          |
| Noor                  | •                  | •                                  |                              |                         |                          |
| Normo                 |                    | •                                  | •                            |                         |                          |
| Nu                    |                    | •                                  | •                            |                         |                          |
| October               |                    | •                                  |                              |                         |                          |
| Revo                  |                    |                                    | •                            |                         |                          |
| Revo Tables           |                    | •                                  |                              |                         |                          |
| Seven                 |                    |                                    |                              |                         |                          |
| SoftBox               | •                  | •                                  |                              |                         |                          |
| Sorriso               |                    | •                                  | •                            |                         |                          |
| Tables SH/SR/SV/SW    |                    | •                                  | •                            |                         |                          |
| Trillo <sup>Pro</sup> |                    |                                    | •                            |                         |                          |
| Vancouver Lite        |                    | •                                  |                              |                         |                          |
| Vancouver Oto         | •                  | •                                  |                              |                         |                          |
| Wall In               | •                  | •                                  |                              |                         |                          |
| Zoo                   | •                  | •                                  | •                            | •                       |                          |

Details in additional information on specific models.

# Consumption of fabric and leather

The quantities below are only estimated. The real quantity of fabric- or leather-consumption may vary in accordance to the quantity of pieces on order. Please notice that before we accept any order in customer's own material we need to make sample trials. Please be aware that not every type of fabric/leather is suitable for upholstery. Volume of customer's own material must be agreed each time with Profim sales organization

Column A - Estimated consumption of fabric (roll width: 1,40 m)

Column B - Estimated consumption of leather (m<sup>2</sup>)

|                           | A   | B   |                            | A    | B    |                | A   | B   |
|---------------------------|-----|-----|----------------------------|------|------|----------------|-----|-----|
| <b>Acos<sup>Pro</sup></b> |     |     | <b>Ellie<sup>Pro</sup></b> |      |      | <b>Revo</b>    |     |     |
| 30H, 30HC, 30V            | 1,2 | 1,8 | 10                         | 2,5  | -    | P40            | 1,5 | -   |
|                           |     |     | 20                         | 2,4  | -    | P60            | 2,2 | -   |
| <b>Ariz</b>               |     |     | <b>Fan</b>                 |      |      | SW120          | 2,4 | -   |
| 560, 575                  | 0,6 | -   | 10                         | 1,4  | 1,9  | SW180          | 3,2 | -   |
| 570                       | 1,6 | -   | 20                         | 2,4  | 3,3  | SW240          | 3,9 | -   |
| <b>Bit</b>                |     |     | cushion                    | 0,5  | 0,5  | SN150          | 2,6 | -   |
| 560, 575                  | 0,6 | -   | <b>Mickey</b>              |      |      | SN210          | 3,3 | -   |
| 570                       | 1,0 | -   | seating                    | 0,7  | -    | B90            | 1,2 | -   |
| 580                       | 1,2 | -   | side of the base           | 0,25 | -    | B120           | 1,5 | -   |
| <b>Chic</b>               |     |     | <b>MyTurn Sofa</b>         |      |      | B180           | 2,1 | -   |
| 10                        | 2,2 | 3,5 | 10                         | 3,8  | 7,4  | W90            | 2,9 | -   |
| 20                        | 1,2 | 1,4 | 20                         | 6,0  | 10,0 | W120           | 3,8 | -   |
| 21                        | 1,0 | 1,1 | 30                         | 8,7  | 13,0 | W180           | 5,6 | -   |
| <b>Chic Lounge</b>        |     |     | <b>Normo</b>               |      |      | <b>SoftBox</b> |     |     |
| A10                       | 2,2 | 4,0 | 500                        | 1,0  | -    | 10, S2         | 2,2 | 2,4 |
| A20                       | 2,1 | 3,3 | <b>Nu</b>                  |      |      | 1C             | 2,5 | 4,0 |
| PV3                       | 1,2 | 1,6 | 20                         | 1,6  | -    | 11             | 3,2 | 5,5 |
| CU                        | 0,4 | 0,3 | <b>October</b>             |      |      | 20             | 3,0 | 4,0 |
| <b>Cushion</b>            |     |     | 10                         | 2,0  | 2,1  | 2B             | 4,4 | 6,0 |
| CU30                      | 0,4 | -   | 20                         | 3,5  | 4,0  | 2R, 2L         | 4,8 | 6,5 |
| CU40                      | 0,5 | -   | 11                         | 3,6  | 5,7  | 21             | 4,5 | 7,2 |
| <b>Com</b>                |     |     | 21                         | 5,5  | 9,2  | 3B             | 6,6 | 8,7 |
| 22                        | 0,5 | 0,3 | 31                         | 7,7  | 12,2 | 3R, 3L         | 5,8 | 8,9 |
| 32                        | 1,0 | 0,7 | 12                         | 6,5  | 8,5  | 31             | 5,9 | 9,6 |
| 42                        | 1,1 | 1,1 | 22                         | 8,0  | 12,5 | 1CW*           | 1,6 | -   |
| 22CV                      | 0,5 | 0,3 | 32                         | 10,5 | 18,5 | 11W*           | 1,8 | -   |
| 42CV                      | 0,7 | 0,8 |                            |      |      | 2BW*           | 1,7 | -   |
|                           |     |     |                            |      |      | 2RW*, 2LW*     | 2,1 | -   |
|                           |     |     |                            |      |      | 21W*           | 2,6 | -   |
|                           |     |     |                            |      |      | 3BW*           | 2,4 | -   |
|                           |     |     |                            |      |      | 3RW*, 3LW*     | 2,9 | -   |
|                           |     |     |                            |      |      | 31W *          | 3,3 | -   |

\*refers only to screens

## Consumption of fabric and leather

|                             | A   | B   |                   | A   | B   |
|-----------------------------|-----|-----|-------------------|-----|-----|
| <b>Sorriso</b>              |     |     | <b>Wall In</b>    |     |     |
| 10                          | 2,1 | 2,6 | 10, 11, 12, 13, B | 1,5 | 2,0 |
| <b>Trillo<sup>Pro</sup></b> |     |     | 20, 21            | 1,8 | 2,7 |
| 20                          | 0,6 | -   | 22, 23            | 1,8 | 2,7 |
| 21                          | 1,2 | -   | 30, 31, 32        | 2,3 | 3,2 |
| <b>Vancouver Lite</b>       |     |     | C1, B1            | 1,6 | 1,4 |
| 1 H/V                       | 2,6 | 4,1 | C2, B2, P1        | 1,6 | 1,7 |
| 2 H/V                       | 3,6 | 5,9 | P3, P4            | 1,2 | 1,7 |
| 2,5 H/V                     | 4,0 | 6,7 | W                 | 1,7 | -   |
| 3 H/V                       | 5,1 | 8,4 | <b>Zoo</b>        |     |     |
| 1 HW/VW                     | 1,9 | 3,2 | 502               | 0,7 | -   |
| 2 HW/VW                     | 2,6 | 4,8 | 500               | 1,1 | -   |
| 2,5 HV/VW                   | 2,9 | 5,5 |                   |     |     |
| 3 HV/VW                     | 3,5 | 6,5 |                   |     |     |
| W1                          | 6,7 | -   |                   |     |     |
| W2                          | 6,7 | -   |                   |     |     |
| W2,5                        | 8,9 | -   |                   |     |     |
| W3                          | 8,9 | -   |                   |     |     |
| SW                          | 5,5 | -   |                   |     |     |
| <b>Vancouver Oto</b>        |     |     |                   |     |     |
| R1, R1B                     | 1,2 | 1,6 |                   |     |     |
| R2, R2B                     | 1,0 | 1,1 |                   |     |     |
| S1, S1B                     | 1,8 | 2,6 |                   |     |     |
| S2, S2B                     | 1,1 | 1,3 |                   |     |     |



# Quilting



Bit / Com

Q1 - quilting on the seat pad  
Q2 - quilting on the backrest pad

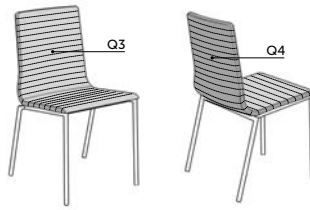

Acos<sup>Pro</sup> / Com

Q3 - quilting on the whole front part  
Q4 - quilting on the whole rear part



Nu / Sorriso

Q5 - quilting on the seat cushion

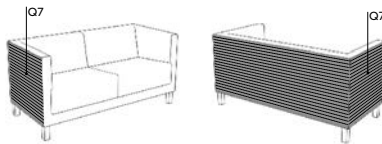

MyTurn Sofa / Vancouver Lite

Q7 - quilting on the outer part of the sides and the back

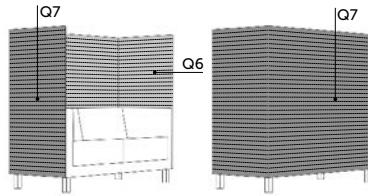

Vancouver Lite

Q6 - quilting on the inner part of the wall  
Q7 - quilting on the outer part of the wall

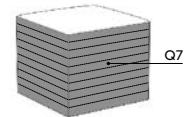

Vancouver Oto

Q7 - quilting on all of the sides

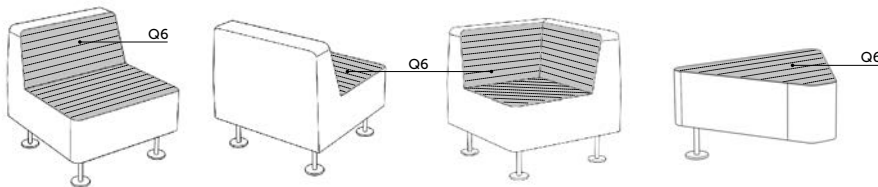

Wall In

Q6 - quilting on the seat and backrest



# Measuring methodology

Swivel armchairs and chairs are measured with a mechanism adjusted in such a way that the seat is as much as it is possible positioned levelly, while the backrest vertically. Swivel armchairs and chairs are measured on their castors, whereas visitor and reception chairs on hard glides. The measurements are approximate and can differ depending on the product configuration.

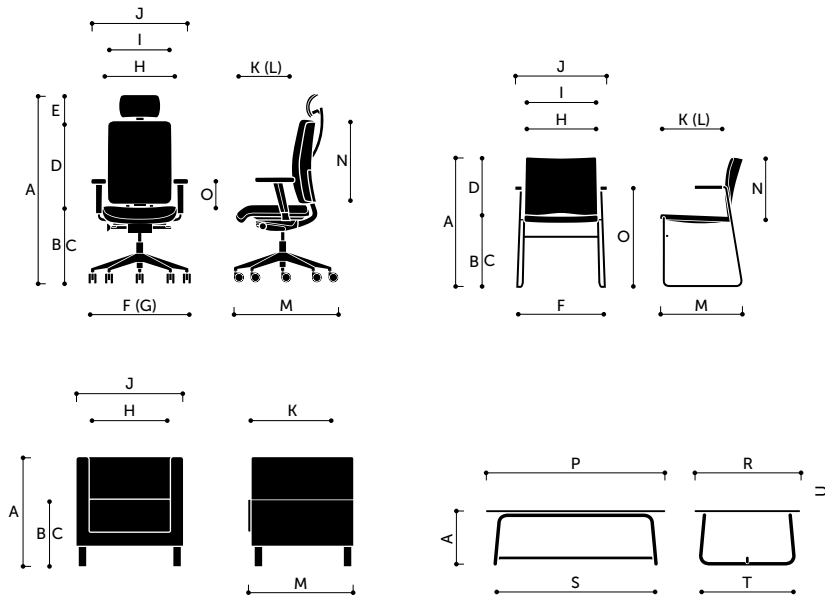

## A - Total height

For products fitted with a gas lift - it is measured with gas lift's minimum and maximum extension. For products fitted with an additional backrest and headrest height adjustment - it is measured in both minimum and maximum positions of the backrest, headrest and gas lift.

## B - Seat height

Measured at the highest point of the seat. For products fitted with a gas lift - it is measured with absorber's minimum and maximum extension.

## C - Seat height with the burden

Seat measured according to EN standards (with seat burden). For products fitted with a gas lift - it is measured with gas lift's minimum and maximum extension.

## D - Backrest height

Measured from the seat to the backrest upper edge. For products with adjustable backrest height - it is measured in the minimum and maximum position.

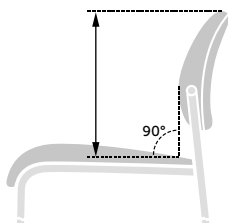

## E - Headrest height

Measured from the backrest upper edge to the headrest upper edge. The headrest adjusted in maximum vertical position in relation to the upper and lower edge of the headrest. Measured in the headrest's minimum and maximum position.

## F - Base, frame width

Measured at the uttermost points of the base according to the following figures.

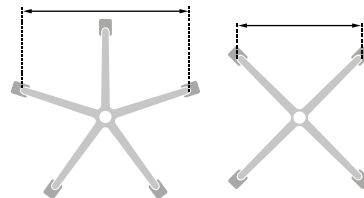

## G - Base diameter

Measured according to the figure underneath.

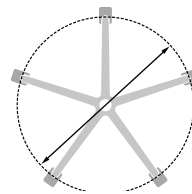

## H - Seat width

Measured at the uttermost points of the seat.

## I - Backrest width

Measured at the uttermost points of the backrest.

## J - Total width

Measured at the uttermost points. For products fitted with adjustable armrests - it is measured with the armrests slid apart to maximum. For products fitted with armrests with adjustable pads - it is measured with the pads slid apart to maximum.

# Measuring methodology

## K - Seat depth

Measuring the distance between the uttermost point on the seat and the point it touches the backrest (the contact point is determined with a level positioned vertically to the backrest by projecting the S point from the backrest onto the seat) (1). For some shell chairs, where there is no distinct border-line between the seat and the backrest, the depth is measured on the bend halfway between the seat and the backrest (2). For products with additional adjustable seat depth - it is measured with minimum and maximum slide.

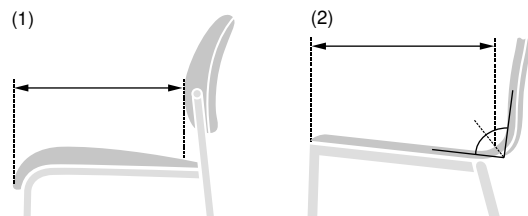

## L - Seat (element) length

Measured at the uttermost points of the seat.

## M - Total depth

Measured at the uttermost points. Swivel armchairs and chairs are measured according to the drawing underneath. For products with adjustable seat depth - it is measured with minimum and maximum slide.

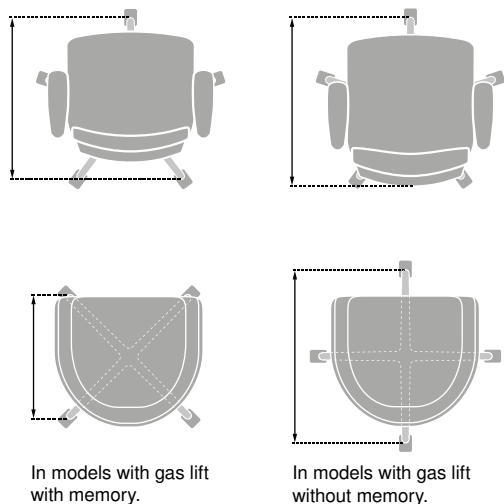

## N - Backrest (element) length

Measured at the uttermost points of the backrest.

## O - Armrest height

For swivel armchairs and chairs – it is measured from the seat surface to the armrest upper edge. For armrests with adjustable height – it is measured in the minimum and maximum position. For visitor chairs – it is measured from the floor to the armrest upper edge.

## P - Table top length

Measured at the uttermost points of the table top.

## R - Table top width

Measured at the uttermost points of the table top.

## S - Table frame length

Measured at the uttermost points of the table frame.

## T - Table frame width

Measured at the uttermost points of the table frame.

## U - Table top thickness

Table top (element) thickness is measured.

# Terms of guarantee

applies to products manufactured after January 15th, 2019

1. Profim (the Guarantor) guarantees the efficient operation of its products.
2. Claims must be submitted at the purchase location, on a claims form (which can be downloaded from [www.profim.eu](http://www.profim.eu)), together with a purchase document (invoice or guarantee) and the guarantee certificate, if the certificate in question was issued to the Purchaser.
3. Claimed products will be accepted only if cleaned, packaged, and secured against damage in shipping.
4. The claimed product should be delivered, along with the documents listed in point 2, to the purchase location. If the claim is rejected, the product is sent back to the purchase location at the cost of the Purchaser.
5. The Guarantor shall determine whether the claim is justified within 14 days from the claimed products' delivery to manufacturer (together with claim application). A claims department employee will contact the Purchaser by phone or e-mail in order to determine the date and manner of product repair/replacement. Any doubts related to the claims procedure may be clarified with our customer service at +46 380 55 53 80 or [info-se@flok.com](mailto:info-se@flok.com). Submitting a claim does not entitle the Purchaser to withhold payment for the product.
6. In order to enable the manufacturer to identify the product, the claim notice should include information from the product's LABEL, i.e. the date of manufacture, order number, product number, and configuration. Any tampering with the LABEL will cause the guarantee to become null and void.
7. Guarantee period.  
Refers to the products listed in the current price list and on the website [www.profim.eu](http://www.profim.eu).

| Guarantee period   | Offer                                   | Operating mode   |
|--|---|--|
| <b>5 years</b><br>not longer however than 7 years from production date | Standard<br>Classic - selected products | 5 days a week,<br>8 hours per day<br>(single shift work) |
| <b>3 years</b><br>not longer however than 4 years from production date | Classic                                 | 5 days a week,<br>8 hours per day<br>(single shift work) |

8. If the product is used for more than 8 hours per day, the guarantee period is reduced to three years.
9. Chair parts (e.g. castors, mechanisms, plastic parts) sold to the Purchaser are covered by a 2 years warranty.
10. If the product is replaced with another product free of defects or repaired by having one of its parts replaced, the course of the guarantee for such product or element is restarted. The guarantee period is extended by the period in which the Purchaser could not make use of the product.
11. If a defect cannot be removed or the removal involves excessive costs, the Guarantor may replace the product with another product free of defects. Any replaced defective products or parts thereof become the property of the Guarantor.
12. In case where an identical product is not available, the Guarantor may replace it with another product free of defects and with identical/similar parameters.

13. Claims concerning mechanical damage (scratches, dents, abrasions, upholstery soiling, missing parts etc.) will be accepted only if submitted within 7 days from the date of handing the product over to the Purchaser. By the above deadline, the Purchaser should unpack the product and remove the wrapping and protective elements in order to rule out mechanical damage. If reservations are made upon delivery with respect to the delivered product, a damage protocol must be drawn up in the presence of the courier or carrier and sent to the Guarantor together with the claims notice.
14. The refusal to hand the product (or any part thereof) over for repair in factory conditions, or preventing repair at the site of the Purchaser, causes the Guarantor to be released from its guarantee obligations and any guarantee claims to be waived.
15. The date of product repair at the site of the Purchaser is scheduled by the Guarantor.
16. Customized products i.e. chairs covered with fabric provided by the Purchaser and manufactured using technology that is not standard for a given product (such as using another base, armrests, covered by a fabric that is not part of standard offer etc.) are covered by one year guarantee.
17. The guarantee covers solely products located on the territory of the Republic of Poland or the country of the Distributor.
18. The Guarantor reserves the right to make innovations in the products that do not alter their durability and usability.
19. Repairs conducted by unauthorized persons or using unauthorized parts will cause the guarantee to become null and void.
20. The Purchaser's rights hereunder do not include the right to pursue lost profits and be indemnified for any potential damage caused by product failure.
21. The Guarantor's liability covers solely defects inherent in the product sold.
22. If the product is damaged after the expiry of the guarantee, the Guarantor may send, if possible, the Purchaser the required element or cure the defect using its factory service. In both cases the Purchaser will be charged accordingly.

# Terms of guarantee

applies to products manufactured after January 15th, 2019

## THE GUARANTEE DOES NOT COVER:

- a) defects caused by assembling the product in a manner not compliant with the manual and using it in a manner not compliant with its purpose,
- b) damage caused during transport and transloading (does not apply to transport provided by the Guarantor),
- c) failure to observe the recommendations contained in the user's manual, damage to castors, glides or floor caused by the inappropriate choice of available options (e.g. using hard castors on hard surfaces); the proper choice of options does not rule out damages that may be caused by using the chairs on carpets, panels, parquet floors etc. of inappropriate quality or on soiled surfaces (e.g. by sand),
- d) damage resulting from extreme climate conditions or environmental factors (e.g. acids, humidity etc.),
- e) damage caused by departing from standard specifications at the customer's request,
- f) operational wear and tear of wheels or upholstery materials,
- g) wear and tear of felt glides, which can be replaced under warranty, only in case the felt come away,
- h) differences in the fabrics shade, if the products come from different manufacturing series of the fabric manufacturer, and differences in individual products purchased by the Purchaser successively are claimed,
- i) discoloration of upholstery caused by some of the clothing colourants and additional colourants (such as those used in denim) which may transfer onto lighter upholstery (the effect can be intensified due to humidity and temperature and is irreversible),
- j) soiling and permanent discolouring of upholstery caused by external factors,
- k) leather upholstery products, where the natural features of the material, such as smell, difference in the structure, texture and shade differences, scars and insects pricks are claimed; during use (e.g. on the seat) the leather takes on shine and becomes looser; the Guarantor does not accept claims motivated by the above features,
- l) foam deformations,
- m) differences in the hardness of polyurethane cold-moulded foam resulting from parameter variations, which according to the DIN 53576/ISO 2439 norm are acceptable if within the range of +/- 10%,
- n) damaging the surface of wooden elements as a result of contact with the edges of desks or other office furniture; mechanical damage of wooden surfaces is not considered to be a product defect,
- o) wooden components used in products, if the slight differences occurring in individual elements are claimed; the character of the raw material makes it impossible to precisely determine the final aesthetic effects, defined by the wood colour, shade, and figure,
- p) differences in geometry of plywood shells, which, because of their natural properties, may differ in tolerance of +/- 1.5 degrees,
- r) small variations in HPL colours, in accordance with PN-EN 438 norm.
- s) differences in colour, gloss, tone or pattern in ceramic table tops. It is natural material and above features are characteristic of this type of surface.

## GENERAL REMARKS CONCERNING PRODUCT USE:

- 23. The products should be protected against the direct influence of sunrays.
- 24. Leather products should not be placed next to a heater or another heat source. Please observe a minimum distance of 30 cm from the heat source.
- 25. Leather should be maintained using special care products that create a protective layer resistant to water and oil substances.
- 26. Products should be protected against becoming wet.
- 27. The upholstery fabric should be protected against soiling by grease, sweat, lubricants etc. In case of soiling, apply appropriate cleaning agents.
- 28. Avoid exposing upholstery to extensive, focused tension (for example standing on a chair) that can result in splitting or a rip of stitching as well as mechanical damage to upholstery.
- 29. Upholstered furniture is supposed to be used to sit evenly on the seat surface to avoid natural tendency of fabrics and leather to creasing and wrinkling due to ongoing pressure, temperature and the moist of the body (wrinkling and creasing is not a product fault but a natural effect; the bigger the upholstered surface the higher tendency for this effect to occur).
- 30. Products should be dusted at least once a week.
- 31. Hard castors are used with soft carpeting and carpets.
- 32. Soft castors are used with hard floors (e.g. PVC, parquet floors, floor panels).
- 33. Remarks concerning the use of products containing plywood elements:
  - temperature range from +15 °C to +30 °C,
  - humidity range from 40% to 65%.
- 34. Ceramic tops meet the frost resistance requirements per EN 10545-12.
- 35. Table Chic RH and RR with metal and ceramic table top (apply only when frame/column is made of EPO1, EPO2, EPO3, with hard or teflon glides) can be for outdoor use according to EN 12944-2 cat. C3.
- 36. Plastic elements of the products like bases, armrests cover (especially light grey colours) require regular cleaning adequate to density of usage.

# Fabrics and finishings

# Profim Standard fabrics

## EVO - PRICE GROUP 0

Evo is a uni-coloured polyester crepe fabric. The irregular weave structure add shine and good stretch.

**Composition:** 100% polyester

**Weight:** 320 g/m<sup>2</sup>

**Abrasion resistance:** 180 000 Martindale (EN ISO 12947-2)

**Flammability:** BS EN 1021: 1-2 (Cigarette & match)

**Light fastness:** 4-5 (EN ISO 105-B02)

**Rubbing fastness:** 4-5 (Wet/Dry) (EN ISO 105-X12)

**Pilling resistance:** 5 (EN ISO 12945-2)

**Environmental facts:** EU Ecolabel, Oeko-Tex® Standard 100, ISO 14001 certified company

**Design:** Miranda Design Team

**Produced in:** Poland

**Cleaning & disinfection:** Dry cleaning with tetrachloroethylene and water solution of carbonate fluoride

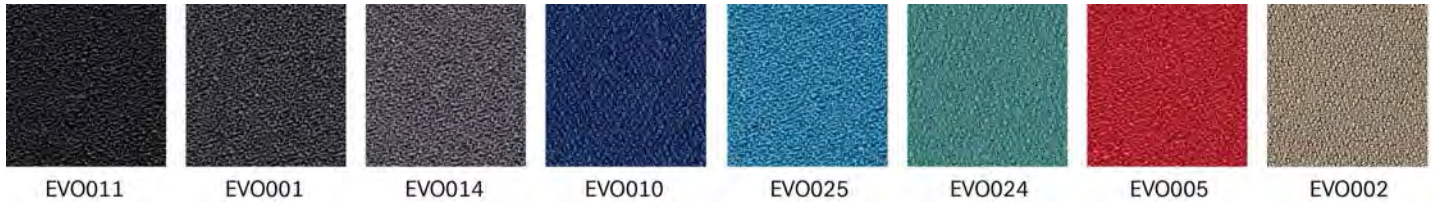

## CURA (GABRIEL) - PRICE GROUP 1

Cura is a two-coloured fabric made from 98% post-consumer recycled polyester. It has a matt, slightly irregular and natural-looking texture where the dark, underlying grey fibers create a discreet yet vibrant melange effect. High durability and stretchability and its soft, voluminous touch make Cura suitable for both office and lounge furniture.

**Composition:** 98% post-consumer recycled polyester, 2% polyester

**Weight:** 420 g/m<sup>2</sup>

**Abrasion resistance:** 100 000 Martindale (EN ISO 12947-2)

**Flammability:** BS EN 1021: 1-2, BS 5852 0&1, CA TB 117-2013, ASTM E 84 Class I

**Light fastness:** 5-8 (EN ISO 105 - B02)

**Rubbing fastness:** 4-5/4-5 (Wet/Dry) (EN ISO 105X12)

**Pilling:** 4-5 (EN ISO 12945-2)

**Environmental facts:** EU Ecolabel, Oeko-Tex® Standard 100, Contains no Flame Retardant chemicals, ISO 14001 certified company

**Design:** Cenk Kivrikoglu

**Produced in:** Lithuania

**Cleaning:** Wash or dry cleaning, Can be disinfected with ethanol and is bleach-cleanable (For further info follow Gabriel´s cleaning guidelines – [www.gabriel.dk](http://www.gabriel.dk))

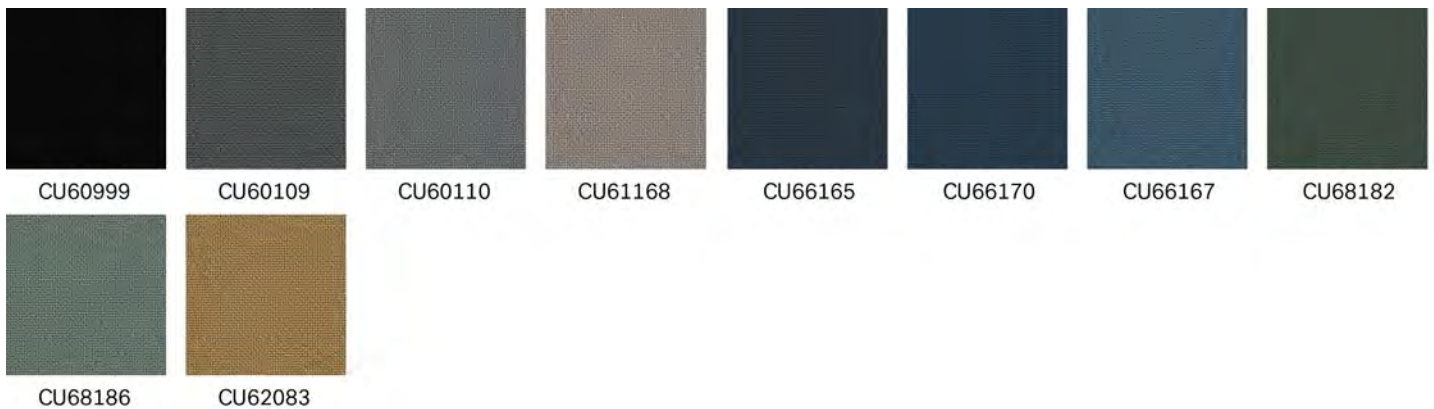



## TONAL (GABRIEL) - PRICE GROUP 1

Tonal is a post-consumer recycled polyester fabric in a two-coloured melange. It has a discreet textured look with a fusion of light and dark tones adding depth to the colours.

**Composition:** 99% post-consumer recycled polyester, 1% polyester

**Weight:** 315 g/lm

**Abrasion resistance:** 100 000 Martindale (EN ISO 12947-2)

**Flammability:** BS EN 1021: 1-2, BS 476 Part 7 class 1, CA TB 117-2013, ASTM E 84 Class I

**Light fastness:** 6-8 (EN ISO 105 - B02)

**Rubbing fastness:** 4-5/4-5 (Wet/Dry) (EN ISO 105X12)

**Pilling:** 4-5 (EN ISO 12945-2)

**Environmental facts:** EU Ecolabel, Oeko-Tex® Standard 100, Contains no Flame Retardant chemicals, ISO 14001 certified company

**Design:** Cenk Kivrikoglu

**Produced in:** Lithuania

**Cleaning:** Wash or dry cleaning. Can be disinfected with ethanol and is bleach-cleanable (For further info follow Gabriel's cleaning guidelines - [www.gabriel.dk](http://www.gabriel.dk))

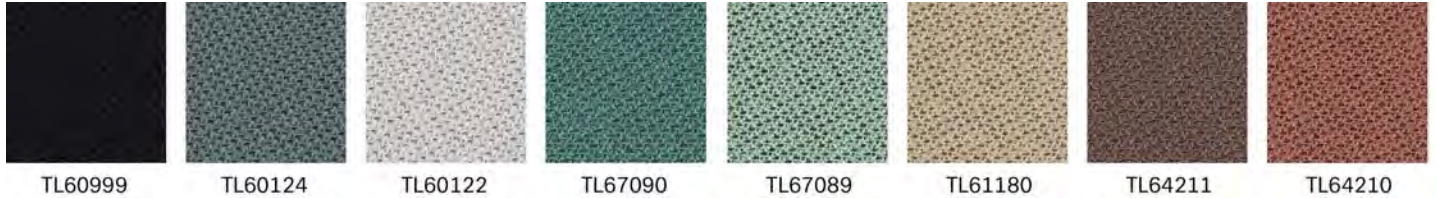

## XTREME (CAMIRA) - PRICE GROUP 1

Xtreme is a crepe fabric made from 100% post-consumer recycled polyester that features exceptional Euro flammability performance. Extra stretch and structure gives an irregular, shiny finish.

**Composition:** 100% post-consumer recycled polyester

**Weight:** 310 g/m<sup>2</sup>

**Abrasion resistance:** >100 000 Martindale (EN ISO 12947-2)

**Flammability:** BS EN 1021: 1-2 (Cigarette & match), BS 7176 Low & Medium Hazard, BS 5852 Section 4 Crib 5, DIN 4102 B1, UNI 9175 Class 1 IM, NF D 60-013

**Light fastness:** 6 (EN ISO 105 - B02: 2013)

**Rubbing fastness:** 4/4 (Wet/Dry) (EN ISO 105X12)

**Pilling:** 5 (EN ISO 12945-2)

**Environmental facts:** EU Ecolabel, Oeko-Tex® Standard 100, Indoor Advantage™ "Gold", non metallic dyestuffs, ISO 14001 certified company.

**Design:** Camira Design Studio

**Produced in:** United Kingdom

**Cleaning & disinfection:** Washable to 60 °C and bleach cleanable (For further info follow Camira's cleaning guidelines - [www.camirafabrics.com](http://www.camirafabrics.com))

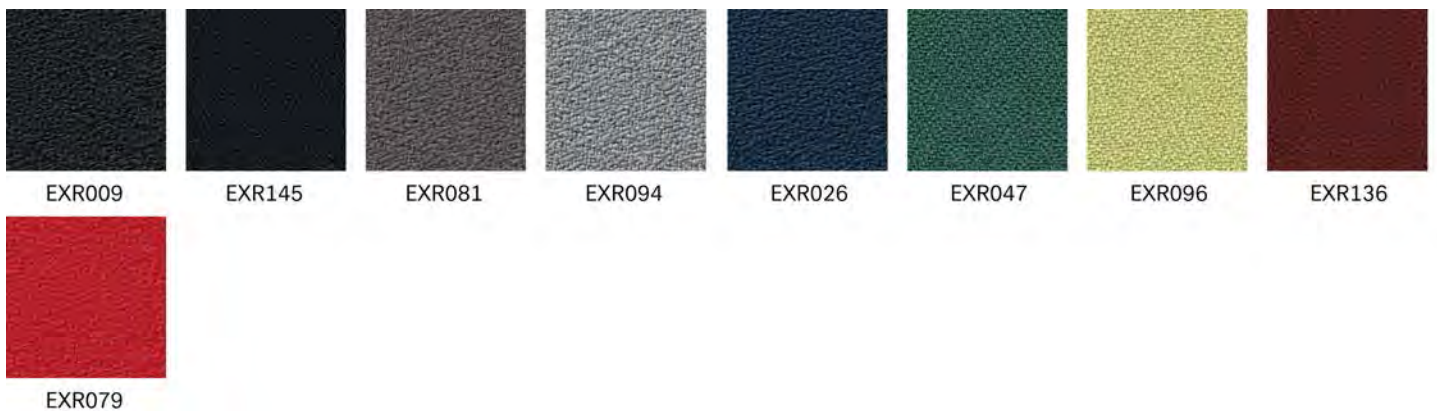

## SELECT (GABRIEL) - PRICE GROUP 2

Select is a classic woolen fabric with a tightly woven relief structure, combining excellent softness, stretch and durability. Its rich texture with the interplay of light and shadow add depth in all the colours in the palette.

**Composition:** 85% New Zealand wool, 15% polyamide

**Abrasion resistance:** 200 000 Martindale (EN ISO 12947-2)

**Flammability:** BS EN 1021: 1-2, BS 5852 0&1, BS5852 Crib 5, CA TB 117-2013, IMO MSC 307(88) Annex 1 part 8/MED registration IMO

**Light fastness:** 5-8 (EN ISO 105 - B02)

**Rubbing fastness:** 4-5/4-5 (Wet/Dry) (EN ISO 105X12)

**Pilling:** 4 (EN ISO 12945-2)

**Environmental facts:** EU Ecolabel, Oeko-Tex® Standard 100, 100% free of heavy metals, ISO 14001 certified company

**Design:** Cenk Kivrikoglu

**Produced in:** Lithuania

**Cleaning:** Professional dry cleaning (For further info follow Gabriel's cleaning guidelines - [www.gabriel.dk](http://www.gabriel.dk))

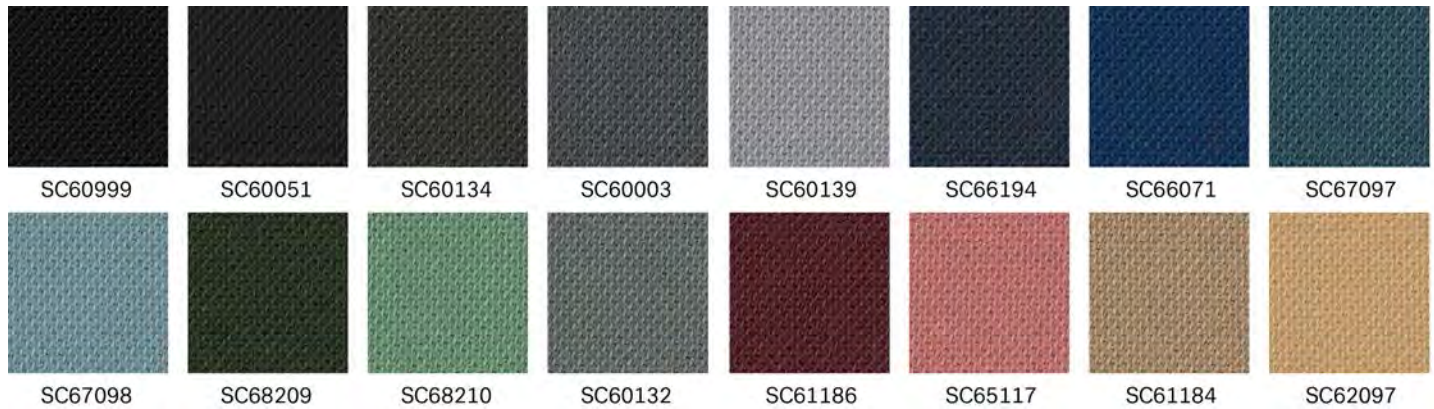

## CAPTURE (GABRIEL) - PRICE GROUP 3

Capture is a lightly felted and multi-coloured wool fabric combining softness, stretch and strenght. It fuses light and dark colours to a refined melange pattern in subtle nuances, which add richness and depth to the design.

**Composition:** 85% New Zealand wool, 15% polyamide

**Abrasion resistance:** 200.000 Martindale (EN ISO 12947-2)

**Flammability:** BS EN 1021: 1-2 (Cigarette & match), BS 5852 Part 1 0,1 (Cigarette & match), CA TB 117-2013, Class Uno UNI 9175 Class 1 IM

**Light fastness:** 5-7 (EN ISO 105-B02)

**Rubbing fastness:** 4-5/4-5 (Wet/Dry) (EN ISO 105X12)

**Pilling:** 4-5 (EN-ISO 12945-2)

**Environmental facts:** EU Ecolabel, Oeko-Tex® Standard 100, 100% free of heavy metals, ISO 14001 certified company

**Design:** Cenk Kivrikoglu

**Produced in:** Lithuania

**Cleaning:** Professional dry cleaning (For further info follow Gabriel's cleaning guidelines - [www.gabriel.dk](http://www.gabriel.dk))



## OCEANIC (CAMIRA) - PRICE GROUP 3

Oceanic is made from 100 % post-consumer recycled polyester yarn where 90% are created from post-consumer plastic bottles diverted from landfill and 10% is upcycled marine plastic(from marine litter). It is a fabric born out of the SEAQUAL Initiative designed to combat marine plastic pollution and achieve a waste free environment. Oceanic has a two coloured diagonal structure with a matte surface and soft touch.

**Composition:** 100 % post-consumer recycled polyester, including 50% SEAQUAL yarn

**Weight:** 497 g/m<sup>2</sup> ±5%

**Abrasion resistance:** >100 000 Martindale (EN ISO 12947-2)

**Flammability:** BS EN 1021: 1-2 (Cigarette & match), BS 7176 Low, BS 7176 Medium Hazard with EnviroFlam5, CA TB 117-2013

**Light fastness:** 5 (EN ISO 105 - B02: 2013)

**Rubbing fastness:** 4/4 (Wet/Dry) (EN ISO 105X12)

**Pilling:** 4 (EN ISO 12945-2)

**Environmental facts:** EU Ecolabel, Oeko-Tex® Standard 100, Indoor Advantage™ "Gold", non metallic dyestuffs, ISO 14001 certified company.

**Design:** Camira Design Studio

**Produced in:** United Kingdom

**Cleaning & disinfection:** Washable at 60 °C and bleach cleanable (For further info follow Camira´s cleaning guidelines – [www.camirafabrics.com](http://www.camirafabrics.com))

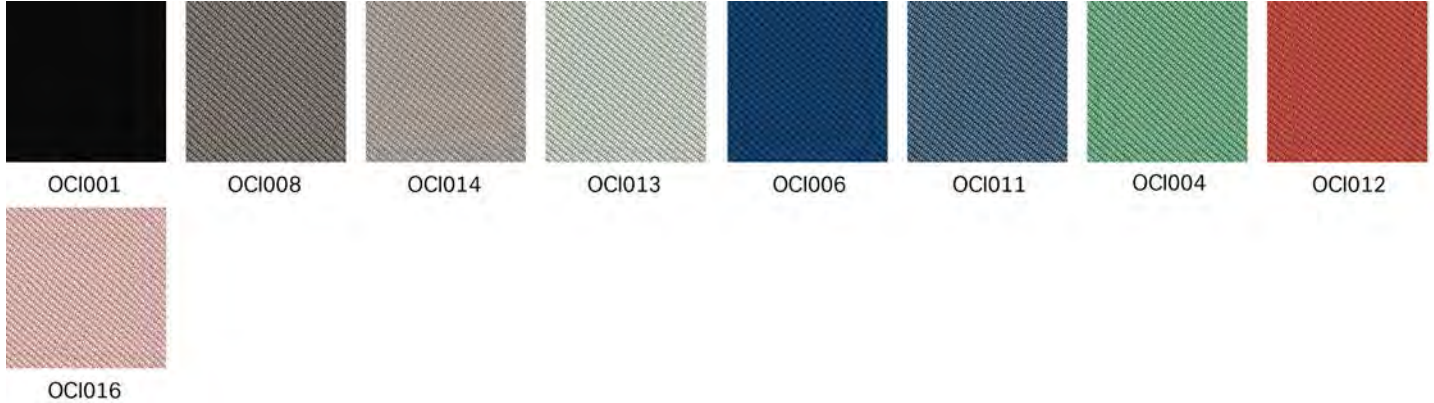

## STEP (GABRIEL) - PRICE GROUP 3

Step is unique in both texture and performance. With its delicate surface, Step is perceived as vivid and interesting. The texture with the fire-resistant Trevira CS yarn ensures that the fabric is suited for use in environments with high fire safety and durability requirements.

**Composition:** 100% Trevira CS

**Weight:** 336 g/m<sup>2</sup>

**Composition:** 100% Trevira cs

**Abrasion resistance:** 100 000 Martindale (EN ISO 12947-2)

**Flammability:** BS EN 1021: 1&2 (Cigarette & match), BS 5852 0&1 (Cigarette & match), BS 5852 Crib 5, CA TB 117-2013, MED Certificate IMO, Class Uno UNI 9175 Class 1 EMME, ÖNORM

**Light fastness:** 5-7 (EN ISO 105 - B02)

**Rubbing fastness:** 4-5/4-5 (Wet/Dry) (EN ISO 105X12)

**Pilling:** 4-5 (EN ISO 12945-2)

**Environmental facts:** EU Ecolabel, Oeko-Tex® Standard 100, 100% free of heavy metals, ISO 14001 certified company

**Design:** Inger Mosholt Nielsen

**Produced in:** Lithuania

**Cleaning:** Professional dry cleaning (For further info follow Gabriel's cleaning guidelines [www.gabriel.dk](http://www.gabriel.dk))

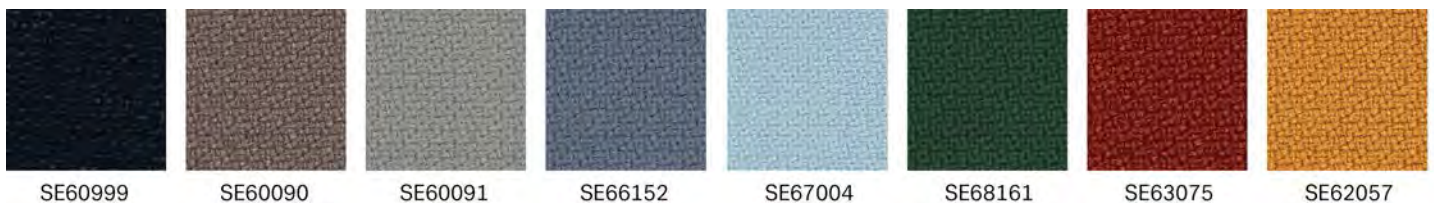

## SYNERGY (CAMIRA) - PRICE GROUP 3

Epitomising natural simplicity, Synergy is a wool rich fabric which is at once both irresistibly soft and ultra-high performing. Delicately felted, with a beautifully relaxed drape, the understated aesthetics showcase the intriguing coloration of this considered textile.

---

**Composition:**

- 95% wool
- 5% polyamide
- **Weight:** 400 g/m<sup>2</sup>

---

**Certificates:**

- **Abrasion resistance:** 100000 Martindale cycles (BS-EN ISO 12947-2)
- **Pilling resistance:** 4 (BS-EN ISO 12945-2)
- **Flammability:** cigarette (BS-EN 1021-1)
- **Flammability:** match (BS-EN 1021-2)
- **Flammability:** (UNI 9175 Class 1IM)
- **Light fastness:** 5 (ISO 105-B02)
- **Maintenance:**
  - -vacuum regularly
  - -use dry-clean preparations
  - -do not bleach

---

Because of the fact that the fabric Synergy is composed of 95% natural fiber, each of the batches shows variations in shade, which may be visible in products of follow-up orders. Additionally, an inherent feature of all natural fibers is the tendency to delicate fabric pilling.

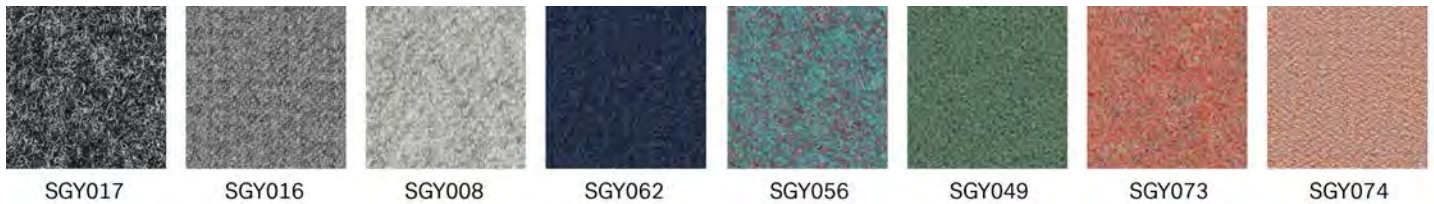

## STEELCUT 3 (KVADRAT) - PRICE GROUP 4

Steelcut 3 is a unicoloured strong worsted wool and polyamide woven fabric, combining durability, soft touch and colour depth. The construction create a three-dimensional surface resembling small pyramids or steel points. Despite its complex weaving technique, it has a simple and precise expression.

**Composition:** 90% worsted new wool, 10% polyamide

**Weight:** 825 g/lm

**Abrasion resistance:** 100 000 Martindale (EN ISO 12947-2)

**Flammability:** BS EN 1021: 1-2 (Cigarette & match, CA TB 117-2013, BS 5852 Crib 5 (with treatment), BS 5852 part 1, IMO FTP Code 2010 Part 8, NF D 60 013, NFPA 260, UNI 9175 1IM, ÖNORM B1/Q1, AS/NZS 3837 Class 2, ASTM E84 Class A Unadhered, ASTM 84 Class B Adhered

**Light fastness:** 5 6 (EN ISO 105-B02)

**Rubbing fastness:** 3-5/4-5 (Wet/Dry) (EN ISO 105X12)

**Pilling:** 3-4 (EN ISO 12945-2)

**Environmental facts:** EU Ecolabel, 100% free of heavy metals, ISO 14001 certified company, GREENGUARD Gold

**Design:** Frans Dijkmeijer, Giulio Ridolfo (updated colourways)

**Produced in:** United Kingdom

**Cleaning:** Professional dry cleaning with tetrachloroethylene, normal process (For further info follow Kvadrat´s cleaning guidelines – [www.kvadrat.dk](http://www.kvadrat.dk))

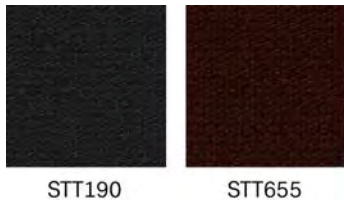

## STEELCUT TRIO 3 (KVADRAT) - PRICE GROUP 4

Steelcut Trio 3 is a strong worsted wool and polyamide woven fabric, made with three different coloured yarns. The colours and the special weave create a three-dimensional surface where the colours seem to change depending on the angle of perspective. Like Steelcut 3, despite the complexity of the textile's innovative weave, it has a simple, precise expression.

**Composition:** 90% worsted new wool, 10% polyamide

**Weight:** 770 g/lm

**Abrasion resistance:** 100 000 Martindale (EN ISO 12947-2)

**Flammability:** BS EN 1021: 1-2 (Cigarette & match, CA TB 117-2013, . BS 5852 Crib 5 (with treatment), BS 5852 part 1, BS 5852 ignition source 3, IMO FTP Code 2010 Part 8, NF D 60 013, NFPA 260, UNI 9175 1IM, ÖNORM B1/Q1, AS/NZS 3837 Class 2, GB 50222 B1 with treatment (Chinese)

**Light fastness:** 6-7 (EN ISO 105-B02)

**Rubbing fastness:** 3-5/4-5 (Wet/Dry) (EN ISO 105X12)

**Pilling:** 4 (EN ISO 12945-2)

**Environmental facts:** EU Ecolabel, 100% free of heavy metals, ISO 14001 certified company, GREENGUARD Gold

**Design:** Frans Dijkmeijer, Giulio Ridolfo (updated colourways)

**Produced in:** United Kingdom

**Cleaning:** Professional dry cleaning with tetrachloroethylene, normal process (For further info follow Kvadrat's cleaning guidelines – [www.kvadrat.dk](http://www.kvadrat.dk))



## PALOMA SOFT (WOLLSDORF) - PRICE GROUP 6

High quality semi-aniline leather. All our standard colours from Paloma have a special finish adding a particular softness to the leather. Excellent friction and breathing properties. The surface may feature small scars and marks resulting from insect bites etc. These are proof of the natural origin of the product and are part of its character.

**Flammability:** BS EN 1021: 1-2 (Cigarette & match), BS 5852 Crib 5, IMO A.652 (16)

**Light fastness:** 6 (EN ISO 105-B02)

**Rubbing:** Wet 80/4 -Dry 2000/4 - Sweat 50/4 - ISO 11640

**Finish-adhesion:** 2.0 N/cm ISO 11644

**Tear-strength:** 20 N/mm DIN 53329- A

**Environmental facts:** Tanned without using chromium salts, BlueAngel, ECO2L-certificate, ISO 14001 certified company

**Produced in:** Austria

**Animal Welfare:** All hides are by-products from the meat and dairy industries, only use hides from healthy and uninjured animal. Following European standards as a minimum and the "Five Freedoms" of livestock as defined by FAWC (Farm Animal Welfare Council)

**Cleaning:** Follow the leather care guide from our supplier – [www.wollsdorf.com](http://www.wollsdorf.com)



# Fabrics and finishings

## Mesh

Ariz

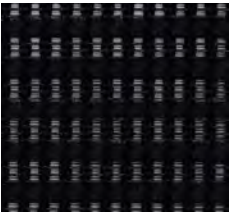

GZ-21

## Mesh

Bit



Runner 60061

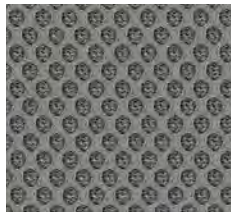

Runner 60011



Runner 60999

## Mesh

Zoo



Runner 60061

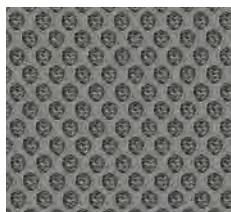

Runner 60011



Runner 60999

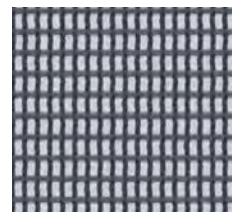

String 60118

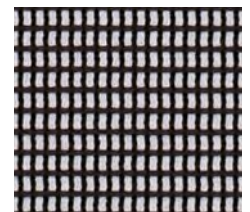

String 60999

# Fabrics and finishings

## Plastics

Ariz

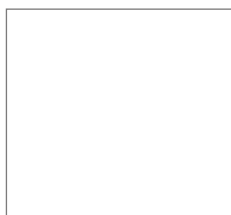

CODE 20



CODE 517

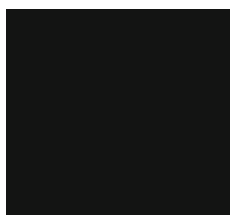

CODE 01



CODE 516



CODE 503



CODE 513



CODE 3020

## Plastics

Ellie<sup>Pro</sup>/ Trillo<sup>Pro</sup>

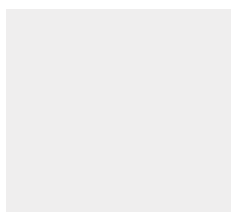

Light grey (RAL 7047)



Black

## Plastics

Mickey

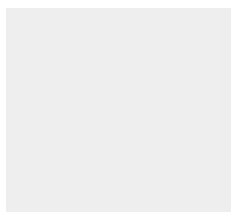

Light grey (RAL 7047)



Grey (RAL 7043)



Beige (RAL 7036)

# Fabrics and finishings

## Plastics / frames

Zoo

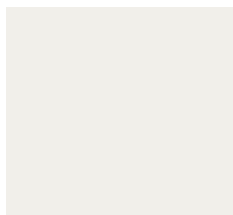

Light grey (NCS S 2500-N)



Grey (NCS S 6500-N)

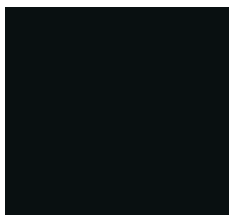

Black (RAL 9005)

## Tempered glass

Chic Tables



G1 (Milky)

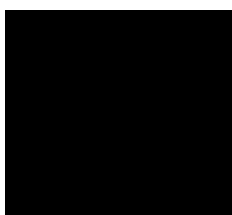

G2 (Black)



G3 (RAL 7044)



G4 (RAL 7042)



# Kolor stelaży / Frame colours / Gestellfarben

Legenda / Legend / Legende:

- Nowość / New colour / Neue Farbe
- Bez zmian / No changes / Keine Änderungen



|                                      |                               | MetallicPro | Chrome | Black / RAL 9005 | White / RAL 9016 | Light Grey / NCS S 2500 N | Grey / NCS S 6500 N | Deep Green / RAL 6004 | Navy Blue / RAL 5003 | Burgundy / RAL 3005 | Salvia/Green / RAL 6021 | Blue / RAL 5014 | Terracota / RAL 3012 | Gold | Metalsilver | Graphite |
|--------------------------------------|-------------------------------|-------------|--------|------------------|------------------|---------------------------|---------------------|-----------------------|----------------------|---------------------|-------------------------|-----------------|----------------------|------|-------------|----------|
| Acos <sup>Pro</sup>                  | V, H, HC                      | ●           | ○      | ○                | ●                | ●                         | ●                   | ●                     | ●                    | ●                   | ●                       | ●               | ●                    |      |             |          |
| Arca                                 | V, V PP                       | ●           | ○      | ○                | ●                |                           |                     |                       |                      |                     |                         |                 |                      |      |             |          |
| Ariz                                 | V, V 2P, CV                   | ●           | ○      | ○                | ●                | ●                         | ●                   | ●                     | ●                    | ●                   | ●                       | ●               | ●                    |      |             |          |
| Bit                                  | H, V                          | ●           | ○      | ○                | ●                |                           |                     |                       |                      |                     |                         |                 |                      |      |             |          |
| Chic                                 | H                             | ●           | ○      | ○                | ○                | ●                         | ●                   | ●                     | ●                    | ●                   | ●                       | ●               | ●                    | ●    |             |          |
| Chic                                 | CH                            | ●           | ○      | ●                | ●                | ●                         | ●                   | ●                     | ●                    | ●                   | ●                       | ●               | ●                    |      |             |          |
| Chic Lounge                          | V3, PV3, F                    | ●           | ○      | ○                | ●                | ●                         | ●                   | ●                     | ●                    | ●                   | ●                       | ●               | ●                    | ●    |             |          |
| Chic Tables                          | RR                            | ●           | ○      | ○                | ●                | ●                         | ●                   | ●                     | ●                    | ●                   | ●                       | ●               | ●                    |      |             |          |
| Chic Tables                          | RH, CS, CR                    | ●           | ○      | ○                | ●                | ●                         | ●                   | ●                     | ●                    | ●                   | ●                       | ●               | ●                    | ●    |             |          |
| Com                                  | HC, HF, HS                    | ●           | ○      | ○                | ●                | ●                         | ●                   | ●                     | ●                    | ●                   | ●                       | ●               | ●                    | ●    |             |          |
| Com                                  | H, H 2P, V, CV, V1, V1 2P, V2 | ●           | ○      | ○                | ●                | ●                         | ●                   | ●                     | ●                    | ●                   | ●                       | ●               | ●                    |      |             |          |
| Ellie <sup>Pro</sup> (polished alu)  | HST                           | ●           | ○      | ○                | ○                |                           |                     |                       |                      |                     |                         |                 |                      |      |             | ○        |
| Ellie <sup>Pro</sup>                 | V3                            | ●           |        | ○                | ●                | ●                         | ●                   |                       |                      |                     |                         |                 |                      | ●    | ○           |          |
| Fan                                  | H, HC, HS, V                  | ●           | ○      | ○                | ●                | ●                         | ●                   | ●                     | ●                    | ●                   | ●                       | ●               | ●                    | ●    |             |          |
| Fan                                  | R                             | ●           | ○      | ●                | ●                | ●                         | ●                   | ●                     | ●                    | ●                   | ●                       | ●               | ●                    |      |             |          |
| MyTurn Sofa                          | H, V                          | ●           | ○      | ○                |                  |                           |                     |                       |                      |                     |                         |                 |                      |      |             |          |
| MyTurn Sofa Tables                   | H, V                          | ●           | ○      | ○                |                  |                           |                     |                       |                      |                     |                         |                 |                      |      |             |          |
| MyTurn                               | VN                            |             | ○      |                  |                  |                           |                     |                       |                      |                     |                         |                 |                      |      |             |          |
| Normo                                | H, V, HS, HC                  | ○           |        | ○                | ○                | ○                         | ○                   | ○                     | ○                    | ○                   | ○                       | ○               | ○                    |      |             |          |
| Nu                                   | H, V3                         | ●           | ○      | ○                | ●                | ●                         | ●                   | ●                     | ●                    | ●                   | ●                       | ●               | ●                    | ●    |             |          |
| Nu (polished alu)                    | HC                            | ●           | ○      | ○                | ○                |                           |                     |                       |                      |                     |                         |                 |                      |      |             | ○        |
| Nu                                   | R                             | ●           | ○      | ●                | ●                | ●                         | ●                   | ●                     | ●                    | ●                   | ●                       | ●               | ●                    |      |             |          |
| October                              | -                             | ●           | ○      | ○                |                  |                           |                     |                       |                      |                     |                         |                 |                      |      |             |          |
| October Tables                       | -                             | ●           | ○      | ○                |                  |                           |                     |                       |                      |                     |                         |                 |                      |      |             |          |
| Revo Tables                          | -                             | ○           |        | ○                | ○                | ●                         | ●                   | ○                     | ○                    | ○                   | ○                       | ○               | ○                    |      |             |          |
| Seven                                | -                             | ●           |        | ○                | ○                | ●                         | ●                   | ●                     | ●                    | ●                   | ●                       | ●               | ●                    |      |             |          |
| SoftBox (polished alu)               | -                             |             | ○      | ○                |                  |                           |                     |                       |                      |                     |                         |                 |                      |      |             |          |
| SoftBox Tables                       | -                             |             | ○      | ○                |                  |                           |                     |                       |                      |                     |                         |                 |                      |      |             |          |
| Sorriso                              | V                             | ●           | ○      | ○                |                  |                           |                     |                       |                      |                     |                         |                 |                      |      |             |          |
| Sun                                  | H, V, H 2P, H 2PB             | ●           | ○      | ○                |                  |                           |                     |                       |                      |                     |                         |                 |                      |      |             |          |
| Tables                               | SV, SH, SR                    | ●           | ○      | ○                | ●                | ●                         | ●                   | ●                     | ●                    | ●                   | ●                       | ●               | ●                    |      |             |          |
| Trillo <sup>Pro</sup> (polished alu) | HST                           | ●           | ○      | ○                | ○                |                           |                     |                       |                      |                     |                         |                 |                      |      |             | ○        |
| Vancouver Lite                       | H, V                          | ●           | ○      | ○                |                  |                           |                     |                       |                      |                     |                         |                 |                      |      |             |          |
| Wall In                              | -                             | ●           | ○      | ○                |                  |                           |                     |                       |                      |                     |                         |                 |                      |      |             |          |
| Xenon                                | H, V, H 2P, V 2P              | ●           | ○      | ○                |                  |                           |                     |                       |                      |                     |                         |                 |                      |      |             |          |
| Xenon Net                            | H, V, H 2P, V 2P              | ●           | ○      | ○                |                  |                           |                     |                       |                      |                     |                         |                 |                      |      |             |          |
| Zoo                                  | H, H 2P, HC, HC 2P            | ●           | ○      | ○                | ●                | ○                         | ○                   |                       |                      |                     |                         |                 |                      |      |             |          |

# Kolory drewna i sklejkki / Wood colours / Holzfarben

Legenda / Legend / Legende:

- Nowość / New colour / Neue Farbe
- Bez zmian / No changes / Keine Änderungen

|                      | Sklejka bukowa / Stained beech / Holz (Schichtholz Buche) |     |    | Okleiny naturalne / Natural veneers / Beiztöne Holz |            |          |             | Okleiny naturalne barwione / Coloured natural veneers / Farben von Edeleurnier |                 |                                 |                                |                               |
|----------------------|---|-----|----|---|------------|----------|-------------|--|-----------------|---------------------------------|--------------------------------|-------------------------------|
|                      | H6  | H12 | H5 | Ash (NA)  | Beech (NB) | Oak (NO) | Walnut (NW) | White Ash CNA01  | Black Ash CNA02 | Deep Green Ash CNA05 (RAL 6004) | Navy Blue Ash CNA06 (RAL 5003) | Burgundy Ash CNA07 (RAL 3005) |
| Chic                 | ○   | ○   | ○  |   |            |          |             |  |                 |                                 |                                |                               |
| Chic Tables          |   |     |    | ●   | ●          | ●        | ●           | ●  | ●               | ●                               | ●                              | ●                             |
| Com                  | ○   | ○   | ○  | ●   |            | ●        | ●           | ●  | ●               | ●                               | ●                              | ●                             |
| Ellie <sup>Pro</sup> | ○   | ○   | ○  |   |            |          |             |  |                 |                                 |                                |                               |
| Fan                  | ○   | ○   | ○  |   |            |          |             |  |                 |                                 |                                |                               |
| MyTurn Sofa Tables   |   |     |    |   |            |          |             |  |                 |                                 |                                |                               |
| Nu                   | ○   | ○   | ○  |   |            |          |             |  |                 |                                 |                                |                               |
| October              | ○   | ○   | ○  |   |            |          |             |  |                 |                                 |                                |                               |
| October Tables       | ○   | ○   | ○  |   |            |          |             |  |                 |                                 |                                |                               |
| Revo Tables          |   |     |    | ○   | ○          | ○        | ○           | ○  | ○               | ○                               | ○                              | ○                             |
| SoftBox Tables       |   |     |    |   |            |          |             |  |                 |                                 |                                |                               |
| Tables SH/SR         |   |     |    |   |            |          |             |  |                 |                                 |                                |                               |
| Tables SW            | ○   | ○   | ○  |   |            |          |             |  |                 |                                 |                                |                               |
| Wall In              |   |     |    |   |            |          |             |  |                 |                                 |                                |                               |

# Kolory drewna i sklejkki / Wood colours / Holzfarben

Legenda / Legend / Legende:

- Nowość / New colour / Neue Farbe
- Bez zmian / No changes / Keine Änderungen

|                      | Okleiny naturalne modyfikowane / Natural modified veneers / Beiztöne Holz |      |      |      |     |                       |                                | Drewno (dąb) / Wood (Oak) / Holz (Buche) |                       |                           |                                |     |      |      |
|----------------------|---|------|------|------|-----|-----------------------|--------------------------------|--|-----------------------|---------------------------|--------------------------------|-----|------|------|
|                      | HM10  | HM11 | HM12 | HM20 | HPL | White LW01 (RAL 9016) | Light Grey LW03 (NCS S 2500-N) | Grey LW04 (RAL 7037)                     | Black LW02 (RAL 9011) | Navy Blue LW06 (RAL 5003) | Light Burgundy LW07 (RAL 3004) | HO6 | HO12 | HO11 |
| Chic                 |   |      |      |      |     |                       |                                |  |                       |                           |                                |     |      |      |
| Chic Tables          |   |      |      |      |     |                       |                                |  |                       |                           |                                |     |      |      |
| Com                  |   |      |      |      |     | ○                     | ●                              | ○  | ○                     | ●                         | ●                              |     |      |      |
| Ellie <sup>Pro</sup> |   |      |      |      |     |                       |                                |  |                       |                           |                                |     |      |      |
| Fan                  |   |      |      |      |     |                       |                                |  |                       |                           |                                | ○   | ○    | ○    |
| MyTurn Sofa Tables   | ○   | ○    | ○    | ○    |     | ●                     |                                | ●  | ●                     |                           |                                |     |      |      |
| Nu                   |   |      |      |      |     |                       |                                |  |                       |                           |                                |     |      |      |
| October              |   |      |      |      |     |                       |                                |  |                       |                           |                                |     |      |      |
| October Tables       |   |      |      |      |     |                       |                                |  |                       |                           |                                |     |      |      |
| Revo Tables          |   |      |      |      |     | ○                     | ●                              | ●  | ○                     | ○                         | ○                              |     |      |      |
| SoftBox Tables       | ○   | ○    | ○    | ○    |     | ○                     |                                | ○  | ○                     |                           |                                |     |      |      |
| Tables SH/SR         |   |      |      |      |     | ○                     | ●                              | ○  | ○                     | ●                         | ●                              |     |      |      |
| Tables SW            |   |      |      |      |     |                       |                                |  |                       |                           |                                | ○   | ○    | ○    |
| Wall In              |   |      |      |      |     | ○                     | ●                              | ○  | ○                     | ●                         | ●                              |     |      |      |

## Kolory kubelków / Shell colours / Schalenfarbe

Legenda / Legend / Legende:

- Standardowy czas realizacji / Standard delivery time / Standardlieferzeit
- Wydłużony czas realizacji / Extended delivery time / Verlängerte Lieferzeit

|                   | Plastics |         |       |      |       |     |           |           |        |            |      |          |                        |          | Veneer shell |                  |  |
|-------------------|----------|---------|-------|------|-------|-----|-----------|-----------|--------|------------|------|----------|------------------------|----------|--------------|------------------|--|
|                   | Poppy    | Vanilla | Straw | Rose | Coral | Sky | Sea Green | Teal Blue | Forest | Misty Grey | Clay | Graphite | Graphite – recycled PP | Charcoal | Oak          | Dark stained Oak |  |
| Ana               | ●        | ●       |       |      |       |     | ○         | ●         |        | ●          |      | ●        | ●                      |          |              |                  |  |
| Noor 6050/6055    | ○        | ●       | ○     | ○    | ○     | ○   | ●         | ●         | ○      | ●          | ●    | ●        |                        |          | ●            | ○                |  |
| Noor 6060/6065    | ○        | ●       | ○     | ○    | ○     | ○   | ●         | ●         | ○      | ●          | ●    | ●        |                        |          | ●            | ○                |  |
| Noor 6070/6075    | ○        | ●       | ○     | ○    | ○     | ○   | ●         | ●         | ○      | ●          | ●    | ●        |                        |          | ●            | ○                |  |
| Noor 6080/6085    | ○        | ●       | ○     | ○    | ○     | ○   | ●         | ●         | ○      | ●          | ●    | ●        |                        |          | ●            | ○                |  |
| Noor Up 6090/6095 | ○        | ●       | ○     | ○    | ○     | ○   | ●         | ●         | ○      | ●          | ●    | ●        |                        |          | ●            | ○                |  |

## Kolory stelaży / Frame colours / Gestellfarbe

Legenda / Legend / Legende:

- Standardowy czas realizacji / Standard delivery time / Standardlieferzeit
- Wydłużony czas realizacji / Extended delivery time / Verlängerte Lieferzeit

|                   | Frames          |                       |        |      |      |           |           |        |            |                |             | Aluminium elements |              |                   |             | Wood (Ash)       |                               |                          | Aluminium elements for base 6080/6085 |  |
|-------------------|-----------------|-----------------------|--------|------|------|-----------|-----------|--------|------------|----------------|-------------|--------------------|--------------|-------------------|-------------|------------------|-------------------------------|--------------------------|---------------------------------------|--|
|                   | Lingon RAL 3000 | Snow (White) RAL 9016 | Canola | Rose | Aqua | Sea Green | Teal Blue | Forest | Misty Grey | Black RAL 9005 | Metalsilver | Steelgrey          | Polished Alu | White stained Ash | Stained Ash | Dark stained Ash | Black painted Aluminium frame | Polished Aluminium frame |                                       |  |
| Ana               | ○               | ●                     |        |      |      | ○         | ●         |        | ●          | ●              | ●           |                    |              |                   |             |                  | ●                             |                          |                                       |  |
| Noor 6050/6055    | ○               | ○                     |        | ○    |      | ●         | ●         | ○      | ○          | ●              | ●           |                    |              |                   |             |                  |                               |                          |                                       |  |
| Noor 6060/6065    | ○               | ●                     | ○      | ○    | ○    | ●         | ●         | ○      | ○          | ●              | ●           |                    |              |                   |             |                  |                               |                          |                                       |  |
| Noor 6070/6075    |                 | ○                     |        |      |      |           |           |        | ●          |                |             | ○                  |              |                   |             |                  |                               |                          |                                       |  |
| Noor 6080/6085    |                 |                       |        |      |      |           |           |        |            |                |             |                    |              | ○                 | ●           | ○                | ●                             | ○                        |                                       |  |
| Noor Up 6090/6095 | ○               | ●                     | ○      | ○    | ○    | ●         | ●         | ○      | ○          | ●              | ●           |                    |              |                   |             |                  | ●                             |                          |                                       |  |

## Kolory blatów / Table tops colours / Plattefarbe

Legenda / Legend / Legende:

- Standardowy czas realizacji / Standard delivery time / Standardlieferzeit
- Wydłużony czas realizacji / Extended delivery time / Verlängerte Lieferzeit

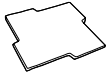

|                        | <b>HPL</b>                    |                         |                          |                             |                           |                     |                            |                               |                                  |                            |                           |                               |                          | <b>Linoleum</b>          |                                |                             |                         |             | <b>Melamine</b> |  |
|------------------------|-------------------------------|-------------------------|--------------------------|-----------------------------|---------------------------|---------------------|----------------------------|-------------------------------|----------------------------------|----------------------------|---------------------------|-------------------------------|--------------------------|--------------------------|--------------------------------|-----------------------------|-------------------------|-------------|-----------------|--|
|                        | Polar White Mat Formica F2255 | Folkstone Formica F7927 | Sarum Grey Formica F2770 | Diamond Black Formica F2253 | Oak natural Formica F1079 | Birch Formica F7921 | Pale Ash Nat Formica F1004 | Elegant Oak Nat Formica F5374 | Refined Walnut Nat Formica F5872 | Dark Ash Nat Formica F8575 | Kashmir Mat Formica F0187 | Oyster Grey Mat Formica F7929 | Pumice Mat Formica F7858 | Olive Forbo Desktop 4184 | Smokey Blue Forbo Desktop 4179 | Burgundy Forbo Desktop 4154 | Iron Forbo Desktop 4178 | Beech M3227 |                 |  |
| Allround               | ●                             | ●                       | ○                        | ○                           | ○                         | ○                   | ○                          | ○                             | ○                                | ○                          | ○                         | ○                             | ○                        | ○                        | ○                              | ○                           | ○                       | ●           |                 |  |
| u-Connect              | ●                             | ●                       | ○                        | ○                           | ○                         | ○                   | ○                          | ○                             | ○                                | ○                          | ○                         | ○                             | ○                        | ○                        | ○                              | ○                           | ○                       | ●           |                 |  |
| Eminent                | ●                             | ●                       | ○                        | ○                           | ○                         | ○                   | ○                          | ○                             | ○                                | ○                          | ○                         | ○                             | ○                        | ○                        | ○                              | ○                           | ○                       | ●           |                 |  |
| Standard Folding table | ●                             | ●                       | ○                        | ○                           | ○                         | ○                   | ○                          | ○                             | ○                                | ○                          | ○                         | ○                             | ○                        | ○                        | ○                              | ○                           | ○                       | ●           |                 |  |

## Kolory stelaży / Frame colours / Gestellfarbe

Legenda / Legend / Legende:

- Standardowy czas realizacji / Standard delivery time / Standardlieferzeit
- Wydłużony czas realizacji / Extended delivery time / Verlängerte Lieferzeit



|                        | Snow RAL 9016 | Misty Grey | Metalsilver | Steelgrey | Black RAL 9005/RAL9011 | Polished aluminium |
|------------------------|---------------|------------|-------------|-----------|------------------------|--------------------|
| Allround               | ●             | ●          | ●           | ●         | ●                      | ○                  |
| u-Connect              | ●             | ●          | ○           | ●         | ●                      | ○                  |
| Eminent                | ●             | ○          | ●           | ●         | ●                      | ○                  |
| Standard Folding table | ○             | ●          | ●           | ●         | ○                      | ○                  |

# Rozmiary blatów / Table top sizes / Plattenmaßen

Legenda / Legend / Legende:

- Standardowy czas realizacji / Standard delivery time / Standardlieferzeit
- Wydłużony czas realizacji / Extended delivery time / Verlängerte Lieferzeit
- Standard / Extended

| cm                     | ø60 | ø70 | ø80 | ø100 | ø120 | ø160 | 1/2 circle ø160 | Ellipse 180 x 100 | Trapezium 140x70x70x70, depth 60 | 80 x 80 | 90 x 60 | 120 x 45 | 120 x 60 | 120 x 70 | 120 x 80 | 120 x 90 | 140 x 60 | 140 x 70 | 140 x 80 | 160 x 70 | 160 x 80 | 180 x 70 | 180 x 80 | 180 x 90 |   |
|------------------------|-----|-----|-----|------|------|------|-----------------|-------------------|----------------------------------|---------|---------|----------|----------|----------|----------|----------|----------|----------|----------|----------|----------|----------|----------|----------|---|
| Allround               | ○   | ●   | ○   | ○    | ○    |      |                 | ○                 |                                  | ○       |         |          |          | ●        | ●        |          |          | ●        | ●        |          |          | ○        | ○        | ●        | ○ |
| u-Connect              |     |     |     |      |      |      |                 |                   |                                  |         |         |          | ●        | ●        | ●        |          | ●        | ●        | ●        | ●        | ●        | ●        | ●        | ●        | ● |
| Eminent                |     |     |     |      | ○    | ○    |                 |                   | ○                                | ○       |         |          | ●        |          | ●        |          | ○        | ●        | ●        |          | ●        |          | ●        |          |   |
| Standard Folding table |     |     |     |      |      |      | ○               |                   |                                  |         | ●       | ●        | ●        | ●        | ●        | ●        | ●        | ●        | ●        | ●        | ●        | ●        | ○        | ●        | ○ |

# Fabrics - Extended

Lead time 30-40 working days

- Legend: ● Possibility of making the product in the given upholstery  
 ○ Possibility of making only the seat in the given upholstery  
 □ No possibility of making the walls in the given upholstery  
 ◇ Handle always in fabric Next  
 - Impossibility of making a product in a given upholstery

|                       | <b>Camira</b> |                     |            |                |                       |              |              |              |              |           |                      | <b>Gabriel</b> |                 |              |              |             |              |                      |                 |                    |                     |  |
|-----------------------|---------------|---------------------|------------|----------------|-----------------------|--------------|--------------|--------------|--------------|-----------|----------------------|----------------|-----------------|--------------|--------------|-------------|--------------|----------------------|-----------------|--------------------|---------------------|--|
|                       | Blazer (PG 3) | Craggan Flax (PG 4) | Era (PG 3) | Gravity (PG 3) | Main Line Flax (PG 3) | Rivet (PG 3) | Nexus (PG 3) | Rivet (PG 3) | Urban (PG 3) | X2 (PG 3) | Breeze Fusion (PG 4) | Chilli (PG 3)  | Comfort+ (PG 5) | Crisp (PG 3) | Cyber (PG 3) | Fame (PG 2) | Focus (PG 3) | Focus Melange (PG 3) | Go_Check (PG 3) | Focus Royal (PG 3) | Gaja Classic (PG 3) |  |
| Ana                   | ●             | ●                   | ●          | ●              | ●                     | ●            | ●            | ●            | ●            | ●         | ●                    | ●              | ●               | ●            | -            | ●           | ●            | ●                    | ●               | ●                  | ●                   |  |
| Ariz                  | ●             | ●                   | ●          | ●              | ●                     | ●            | ●            | -            | ●            | ●         | ●                    | ●              | ●               | -            | ●            | ●           | ●            | ●                    | ●               | -                  | ●                   |  |
| Bit                   | ●             | -                   | ●          | -              | ●                     | ●            | -            | -            | ●            | ●         | -                    | ●              | ●               | -            | ●            | ●           | ●            | ●                    | ●               | -                  | -                   |  |
| Chic                  | ●             | -                   | ●          | -              | ●                     | ●            | ●            | -            | ●            | ●         | -                    | ●              | ●               | -            | ●            | ●           | ●            | ●                    | ●               | -                  | -                   |  |
| Chic Lounge           | ●             | -                   | ●          | -              | ●                     | ●            | -            | -            | ●            | ●         | -                    | ●              | ●               | -            | ●            | ●           | ●            | ●                    | ●               | -                  | -                   |  |
| Com                   | ●             | -                   | ●          | -              | ●                     | ●            | ●            | -            | ●            | ●         | -                    | ●              | ●               | -            | ●            | ●           | ●            | ●                    | ●               | -                  | -                   |  |
| Ellie <sup>Pro</sup>  | ●             | -                   | ●          | -              | ●                     | ●            | -            | -            | ●            | ●         | -                    | ●              | ●               | -            | ●            | ●           | ●            | ●                    | ●               | -                  | -                   |  |
| Fan                   | ●             | -                   | ●          | ●              | ●                     | ●            | ●            | -            | ●            | ●         | -                    | ●              | ●               | -            | ●            | ●           | ●            | ●                    | ●               | -                  | ●                   |  |
| Mickey                | ●             | -                   | ●          | -              | ●                     | ●            | ●            | -            | ●            | ●         | -                    | ●              | ●               | -            | ●            | ●           | ●            | ●                    | ●               | -                  | -                   |  |
| MyTurn Sofa           | ●             | -                   | ●          | -              | ●                     | ●            | -            | -            | ●            | ●         | -                    | ●              | ●               | -            | ●            | ●           | ●            | ●                    | ●               | -                  | -                   |  |
| Noor                  | ●             | ●                   | ●          | ●              | ●                     | ●            | ●            | ●            | ●            | ●         | ●                    | ●              | ●               | ●            | ●            | ●           | ●            | ●                    | ●               | ●                  | ●                   |  |
| Noor F                | ●             | -                   | -          | -              | ●                     | -            | ●            | -            | -            | ●         | -                    | ●              | ●               | -            | ●            | ●           | ●            | ●                    | ●               | ●                  | ●                   |  |
| Normo                 | ●             | -                   | ●          | -              | ●                     | ●            | -            | -            | ●            | ●         | -                    | ●              | ●               | -            | ●            | ●           | ●            | ●                    | ●               | -                  | -                   |  |
| Nu                    | ●             | -                   | ●          | -              | ●                     | ●            | ●            | -            | ●            | ●         | -                    | ●              | ●               | -            | ●            | ●           | ●            | ●                    | ●               | -                  | ●                   |  |
| October               | ●             | ●                   | ●          | -              | ●                     | ●            | ●            | -            | ●            | ●         | -                    | ●              | ●               | -            | ●            | ●           | ●            | ●                    | ●               | -                  | -                   |  |
| Revo                  | ●             | -                   | ●          | -              | ●                     | ●            | -            | -            | ●            | ●         | -                    | ●              | ●               | -            | ●            | ●           | ●            | ●                    | ●               | -                  | -                   |  |
| SoftBox               | ●             | -                   | ●          | -              | ●                     | ●            | ●            | -            | ●            | ●         | -                    | ●              | ●               | -            | ●            | ●           | ●            | ●                    | ●               | -                  | -                   |  |
| Sorriso               | ●             | -                   | ●          | -              | ●                     | ●            | ●            | -            | ●            | ●         | -                    | ●              | ●               | -            | ●            | ●           | ●            | ●                    | ●               | -                  | ●                   |  |
| Trillo <sup>Pro</sup> | ●             | -                   | ●          | -              | ●                     | ●            | -            | -            | ●            | ●         | -                    | ●              | ●               | -            | ●            | ●           | ●            | ●                    | ●               | -                  | -                   |  |
| Vancouver Lite        | ●             | -                   | ●          | -              | ●                     | ●            | ●            | -            | ●            | ●         | -                    | ●              | ●               | -            | ●            | ●           | ●            | ●                    | ●               | -                  | -                   |  |
| Vancouver Oto         | ●             | -                   | ●          | ●              | ●                     | ●            | ●            | -            | ●            | ●         | -                    | ●              | ●               | -            | ●            | ●           | ●            | ●                    | ●               | -                  | ●                   |  |
| Wall In               | ●             | -                   | ●          | -              | ●                     | ●            | ●            | -            | ●            | ●         | -                    | ●              | ●               | -            | ●            | ●           | ●            | ●                    | ●               | -                  | -                   |  |
| Zoo                   | ●             | -                   | ●          | -              | ●                     | ●            | ●            | -            | ●            | ●         | -                    | ●              | ●               | -            | ●            | ●           | ●            | ●                    | ●               | -                  | -                   |  |
| Cushions              | ●             | -                   | ●          | -              | ●                     | ●            | -            | -            | ●            | ●         | -                    | ●              | ●               | -            | ●            | ●           | ●            | ●                    | ●               | -                  | -                   |  |

# Fabrics - Extended

Lead time 30-40 working days

| Gaja C2C (PG 3) | Passion (PG 4) | Step Melange (PG 3) | GU            |               |                 |               |                 |               |                 |                 |               |               |              | Kvadrat       |             |                       |               |                 |                |   |                       |  |
|-----------------|----------------|---------------------|---------------|---------------|-----------------|---------------|-----------------|---------------|-----------------|-----------------|---------------|---------------|--------------|---------------|-------------|-----------------------|---------------|-----------------|----------------|---|-----------------------|--|
|                 |                |                     | Arndal (PG 4) | Bardal (PG 4) | Gandal + (PG 4) | Heidal (PG 4) | Hemsedal (PG 3) | Mandal (PG 4) | Morgedal (PG 4) | Setesdal (PG 4) | Sirdal (PG 4) | Suldal (PG 4) | Atlas (PG 3) | Canvas (PG 4) | Coda (PG 6) | Divina Melange (PG 5) | Divina (PG 5) | Divina MD(PG 5) | Flord 2 (PG 4) |   |                       |  |
| ●               | ●              | ●                   | ●             | ●             | ●               | ●             | ●               | ●             | ●               | ●               | ●             | ●             | ●            | ●             | ●           | ●                     | ●             | ●               | ●              | ● | Ana                   |  |
| ●               | -              | ●                   | ●             | ●             | ●               | ●             | ●               | -             | ●               | ●               | ●             | ●             | ●            | ●             | -           | ●                     | ●             | ●               | -              | ● | Ariz                  |  |
| -               | -              | ●                   | -             | -             | -               | -             | -               | -             | -               | -               | -             | -             | ●            | ●             | -           | ●                     | ●             | -               | -              | ● | Bit                   |  |
| -               | -              | ●                   | ●             | ●             | ●               | ●             | ●               | -             | ●               | ●               | ●             | ●             | ●            | ●             | ●           | ●                     | ●             | ●               | -              | ● | Chic                  |  |
| -               | -              | ●                   | ●             | ●             | ●               | ●             | ●               | -             | ●               | ●               | ●             | ●             | ●            | ●             | ●           | -                     | ●             | ●               | -              | ● | Chic Lounge           |  |
| -               | -              | ●                   | ●             | ●             | ●               | ●             | ●               | -             | ●               | ●               | ●             | ●             | ●            | ●             | -           | ●                     | ●             | ●               | -              | ● | Com                   |  |
| -               | -              | ●                   | ●             | ●             | ●               | ●             | ●               | -             | ●               | ●               | ●             | ●             | ●            | ●             | -           | ●                     | ●             | ●               | -              | ● | Ellie <sup>Pro</sup>  |  |
| -               | -              | ●                   | ●             | ●             | ●               | ●             | ●               | -             | ●               | ●               | ●             | ●             | ●            | ●             | ●           | ●                     | ●             | ●               | -              | ● | Fan                   |  |
| -               | -              | ●                   | ●             | ●             | ●               | ●             | ●               | -             | ●               | ●               | ●             | ●             | ●            | ●             | ◇           | ◇                     | ◇             | ●               | -              | ● | Mickey                |  |
| -               | -              | ●                   | ●             | ●             | ●               | ●             | ●               | -             | ●               | ●               | ●             | ●             | ●            | ●             | ●           | ●                     | ●             | ●               | -              | ● | MyTurn Sofa           |  |
| ●               | ●              | ●                   | ●             | ●             | ●               | ●             | ●               | ●             | ●               | ●               | ●             | ●             | ●            | ●             | ●           | ●                     | ●             | ●               | ●              | ● | Noor                  |  |
| ●               | -              | ●                   | ●             | ●             | -               | ●             | ●               | -             | ●               | ●               | ●             | ●             | -            | -             | ●           | ●                     | ●             | ●               | ●              | ● | Noor F                |  |
| -               | -              | ●                   | ●             | ●             | ●               | ●             | ●               | -             | ●               | ●               | ●             | ●             | ●            | ●             | ●           | ●                     | ●             | ●               | -              | ● | Normo                 |  |
| -               | -              | ●                   | ●             | ●             | ●               | ●             | ●               | -             | ●               | ●               | ●             | ●             | ●            | ●             | ●           | ●                     | ●             | ●               | -              | ● | Nu                    |  |
| -               | -              | ●                   | -             | -             | -               | -             | -               | -             | -               | -               | -             | -             | ●            | ●             | ●           | ●                     | ●             | -               | -              | ● | October               |  |
| -               | -              | ●                   | -             | -             | -               | ●             | -               | -             | -               | -               | -             | -             | ●            | ●             | ●           | ●                     | ●             | -               | -              | ● | Revo                  |  |
| -               | -              | ●                   | ●             | ●             | ●               | ●             | ●               | -             | ●               | ●               | ●             | ●             | ●            | ●             | ●           | ●                     | ●             | ●               | -              | ● | SoftBox               |  |
| -               | -              | ●                   | -             | -             | -               | -             | -               | -             | -               | -               | -             | -             | ●            | ●             | ●           | ●                     | ●             | -               | -              | ● | Sorriso               |  |
| -               | -              | ●                   | -             | -             | -               | -             | -               | -             | -               | -               | -             | -             | ●            | ●             | -           | ●                     | ●             | -               | -              | ● | Trillo <sup>Pro</sup> |  |
| -               | -              | ●                   | ●             | ●             | ●               | ●             | ●               | -             | ●               | ●               | ●             | ●             | ●            | ●             | ●           | ●                     | ●             | ●               | -              | ● | Vancouver Lite        |  |
| -               | -              | ●                   | ●             | ●             | ●               | ●             | ●               | -             | ●               | ●               | ●             | ●             | ●            | ●             | ●           | ●                     | ●             | ●               | -              | ● | Vancouver Oto         |  |
| -               | -              | ●                   | ●             | ●             | ●               | ●             | ●               | -             | ●               | ●               | ●             | ●             | ●            | ●             | ●           | ●                     | ●             | ●               | -              | ● | Wall In               |  |
| -               | -              | ●                   | -             | -             | -               | -             | -               | -             | -               | -               | -             | -             | ●            | ●             | -           | ●                     | ●             | -               | -              | ● | Zoo                   |  |
| -               | -              | ●                   | -             | -             | -               | -             | -               | -             | -               | -               | -             | -             | ●            | ●             | ●           | ●                     | ●             | -               | -              | ● | Cushions              |  |



# Fabrics - Extended

Lead time 30-40 working days

- Legend: ● Possibility of making the product in the given upholstery  
 ○ Possibility of making only the seat in the given upholstery  
 □ No possibility of making the walls in the given upholstery  
 ◇ Handle always in fabric Next  
 - Impossibility of making a product in a given upholstery

























|                       | Foss (PG 5) | Hallingdal 65 (PG 5) | Melange Nap (PG 4) | Naveit (PG 4) | Remix (PG 3) | Re-wood (PG 3) | Twill Weave (PG 5) | Tonus 4 (PG 5) | <b>Nevotex</b> | Illusion (PG 4) | Illusion Full Grain(PG 4) | <b>Oniro</b> | PUxx 1 (PG 3) | PUxx 2 (PG 3) | <b>Spradling</b> | Silvertex (PG 3) | Valencia (PG 1) | <b>Svensson</b> | Khaki (PG 3) | Node (PG 3) | Semi (PG 3) | Step (PG 3) |
|-----------------------|-------------|----------------------|--------------------|---------------|--------------|----------------|--------------------|----------------|----------------|-----------------|---------------------------|--------------|---------------|---------------|------------------|------------------|-----------------|-----------------|--------------|-------------|-------------|-------------|
| Ana                   | ●           | ●                    | ●                  | ●             | ●            | ●              | ●                  | ●              |                | ●               | ●                         |              | ●             | ●             |                  | ●                | ●               |                 | ●            | ●           | ●           | ●           |
| Ariz                  | ●           | ●                    | ●                  | -             | ●            | ●              | ●                  | ●              |                | ○               | -                         |              | ○             | ○             |                  | ●                | ●               |                 | ●            | -           | ●           | ●           |
| Bit                   | -           | -                    | ●                  | -             | ●            | ●              | ●                  | -              |                | -               | -                         |              | -             | -             |                  | ●                | ●               |                 | -            | -           | ●           | -           |
| Chic                  | -           | ●                    | ●                  | -             | ●            | ●              | ●                  | ●              |                | -               | -                         |              | -             | -             |                  | ●                | ●               |                 | -            | -           | ●           | -           |
| Chic Lounge           | -           | ●                    | ●                  | -             | ●            | ●              | ●                  | ●              |                | -               | -                         |              | -             | -             |                  | -                | -               |                 | -            | -           | ●           | -           |
| Com                   | -           | ●                    | ●                  | -             | ●            | ●              | ●                  | ●              |                | -               | -                         |              | ○             | ○             |                  | ●                | ●               |                 | -            | -           | ●           | -           |
| Ellie <sup>Pro</sup>  | -           | ●                    | ●                  | -             | ●            | ●              | ●                  | ●              |                | -               | -                         |              | -             | -             |                  | -                | -               |                 | -            | -           | ●           | -           |
| Fan                   | -           | ●                    | ●                  | -             | ●            | ●              | ●                  | ●              |                | -               | -                         |              | -             | -             |                  | ●                | ●               |                 | -            | -           | ●           | -           |
| Mickey                | -           | ●                    | ●                  | -             | ●            | ●              | ●                  | ●              |                | -               | -                         |              | -             | -             |                  | ◇                | ●               |                 | -            | -           | ●           | -           |
| MyTurn Sofa           | -           | ●                    | ●                  | -             | ●            | ●              | ●                  | ●              |                | -               | -                         |              | -             | -             |                  | ●                | ●               |                 | -            | -           | -           | -           |
| Noor                  | ●           | ●                    | ●                  | ●             | ●            | ●              | ●                  | ●              |                | ●               | ●                         |              | ●             | ●             |                  | ●                | ●               |                 | ●            | ●           | ●           | ●           |
| Noor F                | -           | ●                    | ●                  | -             | ●            | ●              | ●                  | -              |                | -               | -                         |              | -             | -             |                  | -                | -               |                 | -            | ●           | ●           | ●           |
| Normo                 | -           | ●                    | ●                  | -             | ●            | ●              | ●                  | ●              |                | -               | -                         |              | -             | -             |                  | -                | -               |                 | -            | -           | ●           | -           |
| Nu                    | ●           | ●                    | ●                  | -             | ●            | ●              | ●                  | ●              |                | -               | -                         |              | -             | -             |                  | ●                | ●               |                 | -            | -           | ●           | -           |
| October               | -           | -                    | ●                  | -             | ●            | ●              | ●                  | -              |                | -               | -                         |              | -             | -             |                  | ●                | ●               |                 | -            | -           | ●           | -           |
| Revo                  | -           | -                    | ●                  | -             | ●            | ●              | ●                  | -              |                | -               | -                         |              | -             | -             |                  | ●                | ●               |                 | -            | -           | ●           | -           |
| SoftBox               | -           | ●                    | ●                  | -             | ●            | ●              | ●                  | ●              |                | -               | -                         |              | -             | -             |                  | □                | □               |                 | -            | -           | ●           | -           |
| Sorriso               | -           | -                    | ●                  | -             | ●            | ●              | ●                  | ●              |                | -               | -                         |              | -             | -             |                  | ●                | ●               |                 | -            | -           | ●           | -           |
| Trillo <sup>Pro</sup> | -           | -                    | ●                  | -             | ●            | ●              | ●                  | -              |                | -               | -                         |              | -             | -             |                  | ●                | ●               |                 | -            | -           | ●           | -           |
| Vancouver Lite        | -           | ●                    | ●                  | -             | ●            | ●              | ●                  | ●              |                | -               | -                         |              | -             | -             |                  | ●                | ●               |                 | -            | -           | ●           | -           |
| Vancouver Oto         | -           | ●                    | ●                  | -             | ●            | ●              | ●                  | ●              |                | -               | -                         |              | -             | -             |                  | ●                | ●               |                 | -            | -           | ●           | -           |
| Wall In               | -           | ●                    | ●                  | -             | ●            | ●              | ●                  | ●              |                | -               | -                         |              | -             | -             |                  | □                | □               |                 | -            | -           | ●           | -           |
| Zoo                   | -           | -                    | ●                  | -             | ●            | ●              | ●                  | -              |                | -               | -                         |              | -             | -             |                  | ●                | ●               |                 | -            | -           | ●           | -           |
| Cushions              | -           | -                    | ●                  | -             | ●            | ●              | ●                  | -              |                | -               | -                         |              | -             | -             |                  | ●                | ●               |                 | -            | -           | ●           | -           |

# Fabrics - Extended

Lead time 30-40 working days

|  |                       |
|--|-----------------------|
|  | Ana                   |
|  | Ariz                  |
|  | Bit                   |
|  | Chic                  |
|  | Chic Lounge           |
|  | Com                   |
|  | Ellie <sup>Pro</sup>  |
|  | Fan                   |
|  | Mickey                |
|  | MyTurn Sofa           |
|  | Noor                  |
|  | Noor F                |
|  | Normo                 |
|  | Nu                    |
|  | October               |
|  | Revo                  |
|  | SoftBox               |
|  | Sorriso               |
|  | Trillo <sup>Pro</sup> |
|  | Vancouver Lite        |
|  | Vancouver Oto         |
|  | Wall In               |
|  | Zoo                   |
|  | Cushions              |

# Legend

|  |   |   |  |
|--|---|---|--|
|  20,0 | net weight  |    | Ergonomie geprüft                        |
|  22,5 | gross weight  |    | GS (geprüfte Sicherheit)                 |
|  10   | stacking (max. quantity)  |    | Quality Office                           |
|  15   | stacking on trolley for transportation (max. quantity)                                      |    | Möbelfakta                               |
|       | right-sided table top   |    | The Blue Angel                           |
|       | left-sided table top  |   | Forest Stewardship Council®              |
|       | joining in rows   |  | Environmental Product Declarations (EPD) |
|       | two-colour upholstery   |   |  |
|      | teflon glides   |   |  |
|     | felt glides   |   |  |
|     | special threads   |   |  |
|     | clothes hanger  |   |  |
|     | Mediaport   |   |  |
|     | guarantee period  |   |  |
|     | ISO 9001  |   |  |
|     | ISO 14001   |   |  |
|     | Chrom (III)   |   |  |
|     | The mark of responsible forestry.<br>Concerns only products<br>indicated as FSC® certified. |   |  |

Office

Flokk AB  
Rosenlundsgatan 40,  
trapphus B, vån 3  
118 52 Stockholm  
Sweden

Social Media

Facebook  
YouTube  
Instagram  
Pinterest  
LinkedIn

Factory

Flokk AB  
Vallgatan 1  
571 41 Nässjö  
Sweden

# Price List

Valid from the 1st of April 2024  
edition 1  
Swivel chairs

All prices: SEK

**ADDA RAMAVTAL**

# Contents

Profim VIOLLE     

Profim XENON     

Profim XENON NET     

Technical details



Fabrics and finishings

Profim Standard fabrics Fabrics

and finishings - Extended

Legend

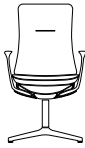
Swivel chairs

| Item no    | Base model +   | Price Group (PG)  | Price Group |       |       |       |        |        | Price  |
|------------|--|---|-------------|-------|-------|-------|--------|--------|--------|
|            |  |   | 0           | ①     | ②     | ③     | ④      | ⑤      |        |
| MLX130F000 | Profim VIOLLE 130F<br><ul style="list-style-type: none"> <li>• visitor</li> <li>• swivel</li> <li>• high backrest</li> <li>• 4-star base</li> <li>• base: white / black/ polished aluminum</li> <li>• non-arm version</li> <li>• teflon glides - universal</li> </ul>      |  | 8 271       | 8 740 | 9 233 | 9 603 | 11 124 | 10 475 | 11 870 |
| MLX150F000 | Profim VIOLLE 150F<br><ul style="list-style-type: none"> <li>• visitor</li> <li>• swivel</li> <li>• high mesh backrest</li> <li>• 4-star base</li> <li>• base: white / black/ polished aluminum</li> <li>• non-arm version</li> <li>• teflon glides - universal</li> </ul> |  | 7 778       | 8 006 | 8 271 | 8 602 | 8 897  | 9 005  | 9 559  |

#### Accessories/Options/Surcharges:

|          |  |       |
|----------|--|-------|
| 7BASC006 | Base: lightgray (Only for: 130SFL, 131SFL, 150SFL, 151SFL)   | 108   |
| 7BASC002 | Base: white (Only for: 130SFL, 131SFL, 150SFL, 151SFL)   | 734   |
| 7BASC003 | Base: polished aluminum (Only for: 130SFL, 131SFL, 150SFL, 151SFL)                                     | 734   |
| 7ARMR016 | Armrests P62PU - black (set) (Only for: 130SFL, 131SFL, 150SFL, 151SFL)                                | 1 794 |
| 7ARMR017 | Armrests P62PU - lightgrey (set) (Only for: 130SFL, 131SFL, 150SFL, 151SFL)                            | 1 987 |
| 7ARMR001 | Armrests - fixed, aluminum, polyurethane pad (set) (Only for: 130F, 150F)                              | 1 854 |
| 7LUSU003 | Lumbar support TYPE B - height and depth adjustable (Only for: 150SFL, 151SFL)                         | 349   |
| 7HANG002 | Clothes hanger (HA) black or light grey - maximum load 4 kg (Only for: 130SFL, 131SFL, 150SFL, 151SFL) | 494   |
| 7PLAP003 | Plastic colours - lightgrey (Only for: 130SFL, 131SFL, 150SFL, 151SFL)                                 | 542   |

**0 price group: Evo**

**1 price group: Cura, Tonal, Xtreme**

**2 price group: Select**

**3 price group: Capture, Oceanic, Step, Synergy**

**4 price group: Steelcut 3, Steelcut Trio 3**

Castors/glides:

- hard castors - for soft floors (set),
- soft castors - for hard floors (set),
- teflon glides - universal (set).

Glides in models 130F / 150F:

- standard - teflon glides (universal),
- option - felt glides (for hard floors).

When ordering please clearly indicate the chosen option.

Armrest P62PU black - height adjustable armrest (range 90 mm), sliding pad (range +/- 50 mm) with span option (+/- 28 mm), polyurethane pad.

Armrest PU - fixed, aluminum, polyurethane pad.

Seat covers can be made also for Rhythm and Runner upholstery. When ordering please clearly indicate the chosen option.

Gas lift with shock absorber - colour of column cover always the same as base colour.

Models Violle 130,150, 151 can be upholstered in Runner or Rhythm mesh.

Headrest may be covered in seat-upholstery or in Rhythm or Runner-mesh. Please clearly indicate on your order the chosen option.

Plastic elements: seat cover+adjustments levers, outer frame in mesh backrest, lumbar support, rear part of headrest.



Aluminium elements: armrest frame, backrest frame. It is not possible to mix different colours in particular group of elements.

In models Violle 130F / 150F gas lift with memory as standard (without height adjustment). Colour of column cover - always the same as base colour.

In models Violle 130F:

- base white and polished aluminium - cover colour lightgrey,

In models Violle 150F:

- cover colour always the same as frame of backrest.

In models with armrests:

- base white and polished aluminium, armpad lightgrey - cover colour lightgrey.

When ordering please clearly indicate the chosen option.



| Item no | Base model + | Price Group (PG) | Price Group |   |   |   |   |   | Price |
|---------|--------------|------------------|-------------|---|---|---|---|---|-------|
|         |              |                  | 0           | ① | ② | ③ | ④ | ⑤ |       |

|            |   |   |       |       |       |       |       |       |       |
|------------|---|---|-------|-------|-------|-------|-------|-------|-------|
| MBC021H000 | Profim XENON 20H<br>• visitor chair<br>• 4-legged<br>• base: black<br>• non-arm version |  | 3 002 | 3 352 | 3 532 | 3 673 | 4 507 | 4 327 | 5 399 |
|------------|---|---|-------|-------|-------|-------|-------|-------|-------|

|            |  |   |       |       |       |       |       |       |       |
|------------|--|---|-------|-------|-------|-------|-------|-------|-------|
| MBC021V000 | Profim XENON 20V<br>• visitor chair<br>• cantilever<br>• stackable<br>• base: black<br>• non-arm version |  | 3 134 | 3 497 | 3 640 | 3 785 | 4 653 | 4 435 | 5 542 |
|------------|--|---|-------|-------|-------|-------|-------|-------|-------|

#### Accessories/Options/Surcharges:

|          |  |     |
|----------|--|-----|
| 7BASC003 | Base: polished aluminum (Only for: 10S, 10SFL, 10SL, 11S, 11SFL, 11SL)                 | 734 |
| 7COPR002 | Frames colours: MetallicPro, (Only for: 20H, 20V)                                      | 33  |
| 7CFRA001 | Frame: chrome (Only for: 20H, 20V)   | 374 |
| 7ARMR006 | Armrests P61PU - black (set) (Only for: 10S, 10SFL, 10SL, 11S, 11SFL, 11SL)            | 589 |
| 7ARMR003 | Armrests P59PU (set) (Only for: 10S, 10SFL, 10SL, 11S, 11SFL, 11SL)                    | 867 |
| 7ARMR001 | Armrests - metal with a polypropylene pad (set) (Only for: 20H, 20V)                   | 289 |
| 7TGAS005 | Gas lift with shock absorber (Only for: 10S, 10SFL, 10SL, 11S, 11SFL, 11SL)            | 252 |
| 7HANG002 | Clothes hanger (HA) - maximum load 4 kg (Only for: 10S, 10SFL, 10SL, 11S, 11SFL, 11SL) | 434 |
| 7SBQU002 | Quilting - front side of the seat (Q1) (Only for: 10S, 10SFL, 10SL, 11S, 11SFL, 11SL)  | 434 |
| 7SBQU003 | Quilting - front of the backrest (Q2) (Only for: 10S, 10SFL, 10SL, 11S, 11SFL, 11SL)   | 517 |
| 7SEQU004 | Quilting - front side of the seat (Q1) (Only for: 20H, 20V)                            | 434 |

**0 price group: Evo**

**1 price group: Cura, Tonal, Xtreme**

**2 price group: Select**

**3 price group: Capture, Oceanic, Step, Synergy**

**4 price group: Steelcut 3, Steelcut Trio 3**

Castors/glides:

- hard castors - for soft floors (set),
- soft castors - for hard floors (set),
- teflon glides - universal (set).

Glides in models 20H / 20V:

- standard - teflon glides (universal),
- option - felt glides (for hard floors).

When ordering please clearly indicate the chosen option.

Armrest P61PU - height adjustable armrest (range 80 mm), polyurethane pad.

Armrest P59PU - height adjustable armrest (range 80 mm), sliding pad (+/- 50 mm) with span option (+/- 30 mm), polyurethane pad.

Armrests P61PU and P59PU are always black, irrespective of the colour of base.

J-bar (backrest bracket) - always in grey colour.

SmartADLS - patented solution and a unique feature of the Xenon collection ensuring proper support of the lower spine.

When ordering please clearly indicate the chosen option.

Quilting - extra charge to all price groups, lead time 30-40 working days.



[www.blauer-engel.de/uz117](http://www.blauer-engel.de/uz117)

| Item no    | Base model +   | Price Group<br>(PG)   | 0     | ①     | ②     | ③     | ④     | ⑤     | ⑥     | Price |
|------------|--|---|-------|-------|-------|-------|-------|-------|-------|-------|
| MBC201H000 | Profim XENON NET 20H<br>• visitor chair<br>• 4-legged<br>• frame: black<br>• non-arm version |  | 3 015 | 3 256 | 3 412 | 3 549 | 4 327 | 3 785 | 4 423 |       |

| Item no    | Base model +  | Price Group (PG)  | Price Group |       |       |       |       |       | Price |
|------------|---|---|-------------|-------|-------|-------|-------|-------|-------|
|            |   |   | 0           | ①     | ②     | ③     | ④     | ⑤     |       |
| MBC201V000 | Profim XENON NET 20V<br>• visitor chair<br>• cantilever<br>• stackable<br>• frame: black<br>• non-arm version |  | 3 148       | 3 400 | 3 545 | 3 687 | 4 435 | 3 894 | 4 544 |

#### Accessories/Options/Surcharges:

|          |   |     |
|----------|---|-----|
| 7BASC003 | Base: polished aluminum   | 734 |
| 7COPR002 | Frames colours: MetallicPro, (Only for: 20H, 20V)   | 33  |
| 7CFRA001 | Frame: chrome (Only for: 20H, 20V)  | 374 |
| 7ARMR006 | Armrests P61PU - black (set) (Only for: 100S, 100SFL, 100SL, 101S, 101SFL, 101SL, 110S, 110SFL, 110SL, 111S, 111SFL, 111SL) | 589 |
| 7ARMR003 | Armrests P59PU (set) (Only for: 100S, 100SFL, 100SL, 101S, 101SFL, 101SL, 110S, 110SFL, 110SL, 111S, 111SFL, 111SL)         | 867 |
| 7ARMR001 | Armrests - metal with a polypropylene pad (set) (Only for: 20H, 20V)  | 289 |
| 7TGAS005 | Gas lift with shock absorber (Only for: 100S, 100SFL, 100SL, 101S, 101SFL, 101SL, 110S, 110SFL, 110SL, 111S, 111SFL, 111SL) | 252 |
| 7HANG002 | Clothes hanger (Only for: 100S, 100SFL, 100SL, 101S, 101SFL, 101SL, 110S, 110SFL, 110SL, 111S, 111SFL, 111SL)               | 434 |
| 7SEQU004 | Quilting - front side of the seat (Q1)  | 434 |

**0 price group: Evo**

**1 price group: Cura, Tonal, Xtreme**

**2 price group: Select**

**3 price group: Capture, Oceanic, Step, Synergy**

**4 price group: Steelcut 3, Steelcut Trio 3**

Castors/glides:

- hard castors - for soft floors (set),
- soft castors - for hard floors (set),
- teflon glides - universal (set).

Glides in models 20H / 20V:

- standard - teflon glides (universal),
- option - felt glides (for hard floors),

When ordering please clearly indicate the chosen option.

Armrest P61PU - height adjustable armrest (range 80 mm), polyurethane pad.

Armrest P59PU - height adjustable armrest (range 80 mm), sliding pad (+/- 50 mm) with span option (+/- 30 mm), polyurethane pad.

Armrests P61PU and P59PU are always black, irrespective of the colour of base.

Type of mesh: Runner, String. Please clearly indicate on your order the chosen option.

In models Xenon Net 110/111 headrest may be covered in seat-upholstery or in Runner-mesh. Please clearly indicate on your order the chosen option.

J-bar (backrest bracket) - always in grey colour.

SmartADLS - patented solution and a unique feature of the Xenon Net collection ensuring proper support of the lower spine.

When ordering please clearly indicate the chosen option.

Quilting - extra charge to all price groups, lead time 30-40 working days.



[www.blauer-engel.de/uz117](http://www.blauer-engel.de/uz117)

# Consumption of fabric and leather

The quantities below are only estimated. The real quantity of fabric- or leather-consumption may vary in accordance to the quantity of pieces on order. Please notice that before we accept any order in customer's own material we need to make sample trials. Please be aware that not every type of fabric/leather is suitable for upholstery. Volume of customer's own material must be agreed each time with Profim sales organization

Column A - Estimated consumption of fabric (roll width: 1,40 m)

Column B - Estimated consumption of leather (m<sup>2</sup>)

|                            | <b>A</b> | <b>B</b> |
|----------------------------|----------|----------|
| <b>Accis<sup>Pro</sup></b> |          |          |
| 150                        | 0,7      | 0,8      |

|               |     |     |
|---------------|-----|-----|
| <b>Action</b> |     |     |
| 100, 110      | 1,5 | 2,0 |
| 105, 115      | 0,6 | 0,8 |
| 580           | 1,2 | -   |

|                |     |   |
|----------------|-----|---|
| <b>LightUp</b> |     |   |
| 230, 330       | 1,2 | - |
| 250, 350       | 0,5 | - |

|              |     |   |
|--------------|-----|---|
| <b>Motto</b> |     |   |
| 10           | 1,4 | - |
| 11           | 1,8 | - |

|               |     |     |
|---------------|-----|-----|
| <b>MyTurn</b> |     |     |
| 10            | 1,7 | 2,3 |
| 20            | 1,6 | 2,1 |

|              |     |     |
|--------------|-----|-----|
| <b>Veris</b> |     |     |
| 10, 101      | 1,5 | 1,2 |
| 11, 111      | 1,8 | 1,2 |

|               |     |     |
|---------------|-----|-----|
| <b>Violle</b> |     |     |
| 130SFL        | 1,8 | 1,5 |
| 131SFL        | 2,1 | 1,7 |
| 150SFL        | 0,6 | 0,6 |
| 151SFL        | 0,9 | 0,8 |
| 130F          | 1,8 | 1,5 |
| 150F          | 0,6 | 0,6 |

|              |     |     |
|--------------|-----|-----|
| <b>Xenon</b> |     |     |
| 10           | 1,5 | 1,5 |
| 11           | 1,9 | 1,7 |

|                  |     |     |
|------------------|-----|-----|
| <b>Xenon Net</b> |     |     |
| 100, 101         | 0,7 | 0,7 |
| 110, 111         | 1,1 | 0,9 |

# Measuring methodology

Swivel armchairs and chairs are measured with a mechanism adjusted in such a way that the seat is as much as it is possible positioned levelly, while the backrest vertically. Swivel armchairs and chairs are measured on their castors, whereas visitor and reception chairs on hard glides. The measurements are approximate and can differ depending on the product configuration.

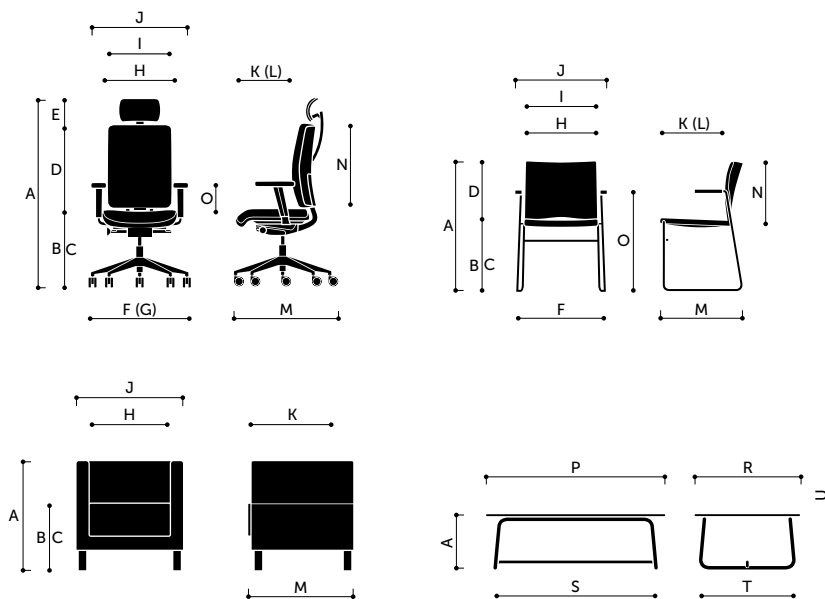

## A - Total height

For products fitted with a gas lift - it is measured with gas lift's minimum and maximum extension. For products fitted with an additional backrest and headrest height adjustment - it is measured in both minimum and maximum positions of the backrest, headrest and gas lift.

## B - Seat height

Measured at the highest point of the seat. For products fitted with a gas lift - it is measured with absorber's minimum and maximum extension.

## C - Seat height with the burden

Seat measured according to EN standards (with seat burden). For products fitted with a gas lift - it is measured with gas lift's minimum and maximum extension.

## D - Backrest height

Measured from the seat to the backrest upper edge. For products with adjustable backrest height - it is measured in the minimum and maximum position.

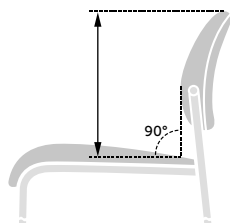

## E - Headrest height

Measured from the backrest upper edge to the headrest upper edge. The headrest adjusted in maximum vertical position in relation to the upper and lower edge of the headrest. Measured in the headrest's minimum and maximum position.

## F - Base, frame width

Measured at the uttermost points of the base according to the following figures.

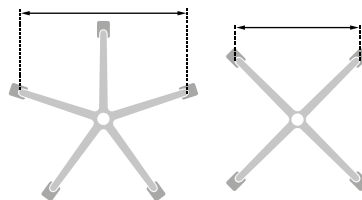

## G - Base diameter

Measured according to the figure underneath.

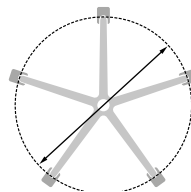

## H - Seat width

Measured at the uttermost points of the seat.

## I - Backrest width

Measured at the uttermost points of the backrest.

## J - Total width

Measured at the uttermost points. For products fitted with adjustable armrests - it is measured with the armrests slid apart to maximum. For products fitted with armrests with adjustable pads - it is measured with the pads slid apart to maximum.



# Measuring methodology

## K - Seat depth

Measuring the distance between the uttermost point on the seat and the point it touches the backrest (the contact point is determined with a level positioned vertically to the backrest by projecting the S point from the backrest onto the seat) (1). For some shell chairs, where there is no distinct border-line between the seat and the backrest, the depth is measured on the bend halfway between the seat and the backrest (2). For products with additional adjustable seat depth - it is measured with minimum and maximum slide.

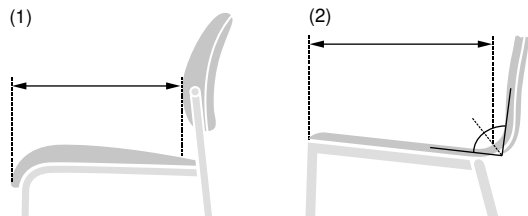

## L - Seat (element) length

Measured at the uttermost points of the seat.

## M - Total depth

Measured at the uttermost points. Swivel armchairs and chairs are measured according to the drawing underneath. For products with adjustable seat depth - it is measured with minimum and maximum slide.

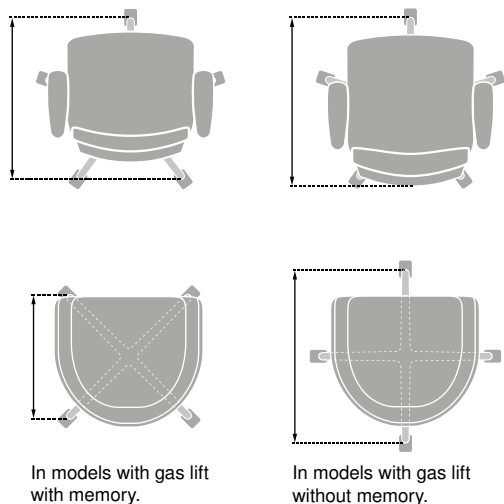

## N - Backrest (element) length

Measured at the uttermost points of the backrest.

## O - Armrest height

For swivel armchairs and chairs – it is measured from the seat surface to the armrest upper edge. For armrests with adjustable height – it is measured in the minimum and maximum position. For visitor chairs – it is measured from the floor to the armrest upper edge.

## P - Table top length

Measured at the uttermost points of the table top.

## R - Table top width

Measured at the uttermost points of the table top.

## S - Table frame length

Measured at the uttermost points of the table frame.

## T - Table frame width

Measured at the uttermost points of the table frame.

## U - Table top thickness

Table top (element) thickness is measured.

# Fabrics and finishings

# Profim Standard fabrics

## EVO - PRICE GROUP 0

Evo is a uni-coloured polyester crepe fabric. The irregular weave structure add shine and good stretch.

**Composition:** 100% polyester

**Weight:** 320 g/m<sup>2</sup>

**Abrasion resistance:** 180 000 Martindale (EN ISO 12947-2)

**Flammability:** BS EN 1021: 1-2 (Cigarette & match)

**Light fastness:** 4-5 (EN ISO 105-B02)

**Rubbing fastness:** 4-5 (Wet/Dry) (EN ISO 105-X12)

**Pilling resistance:** 5 (EN ISO 12945-2)

**Environmental facts:** EU Ecolabel, Oeko-Tex® Standard 100, ISO 14001 certified company

**Design:** Miranda Design Team

**Produced in:** Poland

**Cleaning & disinfection:** Dry cleaning with tetrachloroethylene and water solution of carbonate fluoride

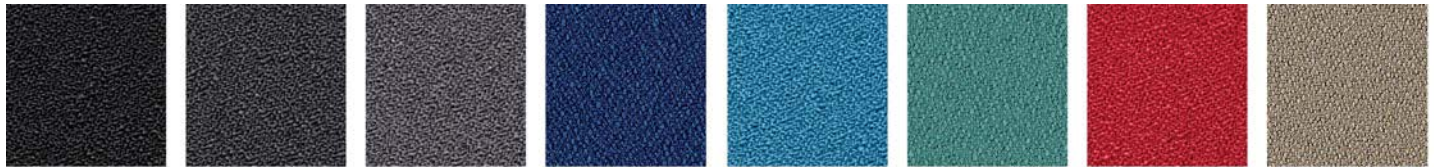

EVO011

EVO001

EVO014

EVO010

EVO025

EVO024

EVO005

EVO002

## CURA (GABRIEL) - PRICE GROUP 1

Cura is a two-coloured fabric made from 98% post-consumer recycled polyester. It has a matt, slightly irregular and natural-looking texture where the dark, underlying grey fibers create a discreet yet vibrant melange effect. High durability and stretchability and its soft, voluminous touch make Cura suitable for both office and lounge furniture.

**Composition:** 98% post-consumer recycled polyester, 2% polyester

**Weight:** 420 g/m<sup>2</sup>

**Abrasion resistance:** 100 000 Martindale (EN ISO 12947-2)

**Flammability:** BS EN 1021: 1-2, BS 5852 0&1, CA TB 117-2013, ASTM E 84 Class I

**Light fastness:** 5-8 (EN ISO 105 - B02)

**Rubbing fastness:** 4-5/4-5 (Wet/Dry) (EN ISO 105X12)

**Pilling:** 4-5 (EN ISO 12945-2)

**Environmental facts:** EU Ecolabel, Oeko-Tex® Standard 100, Contains no Flame Retardant chemicals, ISO 14001 certified company

**Design:** Cenk Kivrikoglu

**Produced in:** Lithuania

**Cleaning:** Wash or dry cleaning, Can be disinfected with ethanol and is bleach-cleanable (For further info follow Gabriel´s cleaning guidelines – [www.gabriel.dk](http://www.gabriel.dk))



CU60999

CU60109

CU60110

CU61168

CU66165

CU66170

CU66167

CU68182



CU68186

CU62083

## TONAL (GABRIEL) - PRICE GROUP 1

Tonal is a post-consumer recycled polyester fabric in a two-coloured melange. It has a discreet textured look with a fusion of light and dark tones adding depth to the colours.

**Composition:** 99% post-consumer recycled polyester, 1% polyester

**Weight:** 315 g/lm

**Abrasion resistance:** 100 000 Martindale (EN ISO 12947-2)

**Flammability:** BS EN 1021: 1-2, BS 476 Part 7 class 1, CA TB 117-2013, ASTM E 84 Class I

**Light fastness:** 6-8 (EN ISO 105 - B02)

**Rubbing fastness:** 4-5/4-5 (Wet/Dry) (EN ISO 105X12)

**Pilling:** 4-5 (EN ISO 12945-2)

**Environmental facts:** EU Ecolabel, Oeko-Tex® Standard 100, Contains no Flame Retardant chemicals, ISO 14001 certified company

**Design:** Cenk Kivrikoglu

**Produced in:** Lithuania

**Cleaning:** Wash or dry cleaning. Can be disinfected with ethanol and is bleach-cleanable (For further info follow Gabriel's cleaning guidelines - [www.gabriel.dk](http://www.gabriel.dk))

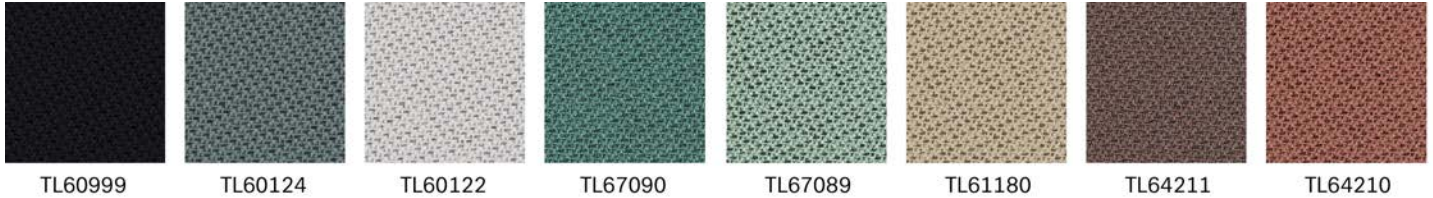

## XTREME (CAMIRA) - PRICE GROUP 1

Xtreme is a crepe fabric made from 100% post-consumer recycled polyester that features exceptional Euro flammability performance. Extra stretch and structure gives an irregular, shiny finish.

**Composition:** 100% post-consumer recycled polyester

**Weight:** 310 g/m2

**Abrasion resistance:** >100 000 Martindale (EN ISO 12947-2)

**Flammability:** BS EN 1021: 1-2 (Cigarette & match), BS 7176 Low & Medium Hazard, BS 5852 Section 4 Crib 5, DIN 4102 B1, UNI 9175 Class 1 IM, NF D 60-013

**Light fastness:** 6 (EN ISO 105 - B02: 2013)

**Rubbing fastness:** 4/4 (Wet/Dry) (EN ISO 105X12)

**Pilling:** 5 (EN ISO 12945-2)

**Environmental facts:** EU Ecolabel, Oeko-Tex® Standard 100, Indoor Advantage™ "Gold", non metallic dyestuffs, ISO 14001 certified company.

**Design:** Camira Design Studio

**Produced in:** United Kingdom

**Cleaning & disinfection:** Washable to 60 °C and bleach cleanable (For further info follow Camira's cleaning guidelines - [www.camirafabrics.com](http://www.camirafabrics.com))

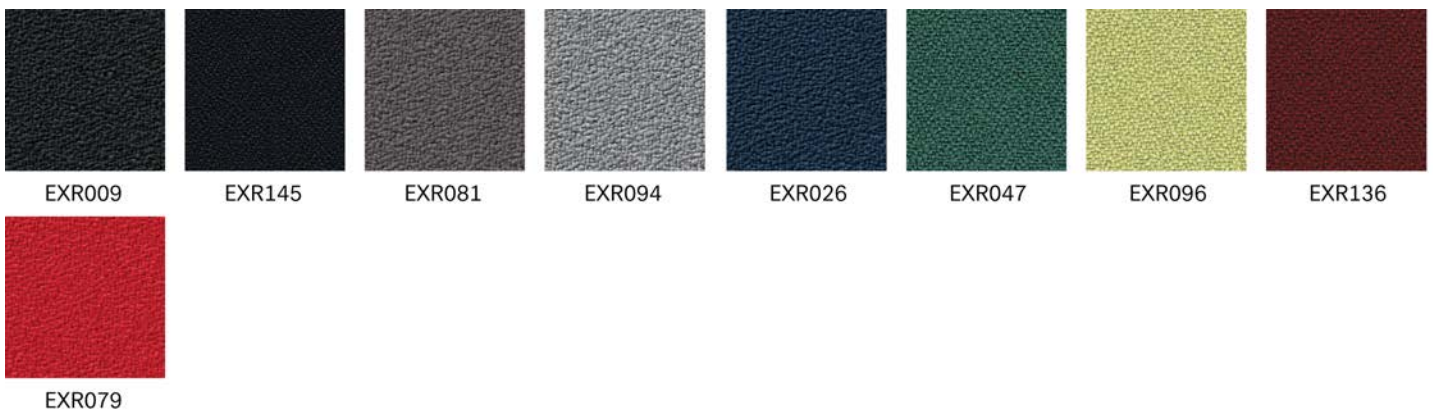

## SELECT (GABRIEL) - PRICE GROUP 2

Select is a classic woolen fabric with a tightly woven relief structure, combining excellent softness, stretch and durability. Its rich texture with the interplay of light and shadow add depth in all the colours in the palette.

**Composition:** 85% New Zealand wool, 15% polyamide

**Abrasion resistance:** 200 000 Martindale (EN ISO 12947-2)

**Flammability:** BS EN 1021: 1-2, BS 5852 0&1, BS5852 Crib 5, CA TB 117-2013, IMO MSC 307(88) Annex 1 part 8/MED registration IMO

**Light fastness:** 5-8 (EN ISO 105 - B02)

**Rubbing fastness:** 4-5/4-5 (Wet/Dry) (EN ISO 105X12)

**Pilling:** 4 (EN ISO 12945-2)

**Environmental facts:** EU Ecolabel, Oeko-Tex® Standard 100, 100% free of heavy metals, ISO 14001 certified company

**Design:** Cenk Kivrikoglu

**Produced in:** Lithuania

**Cleaning:** Professional dry cleaning (For further info follow Gabriel's cleaning guidelines - [www.gabriel.dk](http://www.gabriel.dk))

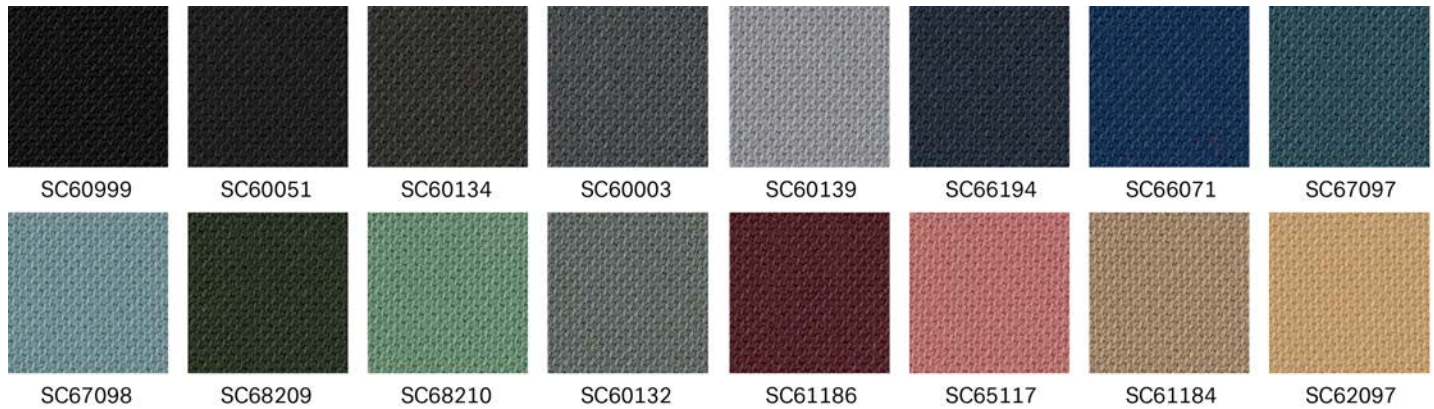

## CAPTURE (GABRIEL) - PRICE GROUP 3

Capture is a lightly felted and multi-coloured wool fabric combining softness, stretch and strenght. It fuses light and dark colours to a refined melange pattern in subtle nuances, which add richness and depth to the design.

**Composition:** 85% New Zealand wool, 15% polyamide

**Abrasion resistance:** 200.000 Martindale (EN ISO 12947-2)

**Flammability:** BS EN 1021: 1-2 (Cigarette & match), BS 5852 Part 1 0,1 (Cigarette & match), CA TB 117-2013, Class Uno UNI 9175 Class 1 IM

**Light fastness:** 5-7 (EN ISO 105-B02)

**Rubbing fastness:** 4-5/4-5 (Wet/Dry) (EN ISO 105X12)

**Pilling:** 4-5 (EN-ISO 12945-2)

**Environmental facts:** EU Ecolabel, Oeko-Tex® Standard 100, 100% free of heavy metals, ISO 14001 certified company

**Design:** Cenk Kivrikoglu

**Produced in:** Lithuania

**Cleaning:** Professional dry cleaning (For further info follow Gabriel's cleaning guidelines - [www.gabriel.dk](http://www.gabriel.dk))



## OCEANIC (CAMIRA) - PRICE GROUP 3

Oceanic is made from 100 % post-consumer recycled polyester yarn where 90% are created from post-consumer plastic bottles diverted from landfill and 10% is upcycled marine plastic (from marine litter). It is a fabric born out of the SEAQUAL Initiative designed to combat marine plastic pollution and achieve a waste free environment. Oceanic has a two coloured diagonal structure with a matte surface and soft touch.

**Composition:** 100 % post-consumer recycled polyester, including 50% SEAQUAL yarn

**Weight:** 497 g/m<sup>2</sup> ±5%

**Abrasion resistance:** >100 000 Martindale (EN ISO 12947-2)

**Flammability:** BS EN 1021: 1-2 (Cigarette & match), BS 7176 Low, BS 7176 Medium Hazard with EnviroFlam5, CA TB 117-2013

**Light fastness:** 5 (EN ISO 105 - B02: 2013)

**Rubbing fastness:** 4/4 (Wet/Dry) (EN ISO 105X12)

**Pilling:** 4 (EN ISO 12945-2)

**Environmental facts:** EU Ecolabel, Oeko-Tex® Standard 100, Indoor Advantage™ "Gold", non metallic dyestuffs, ISO 14001 certified company.

**Design:** Camira Design Studio

**Produced in:** United Kingdom

**Cleaning & disinfection:** Washable at 60 °C and bleach cleanable (For further info follow Camira's cleaning guidelines – [www.camirafabrics.com](http://www.camirafabrics.com))

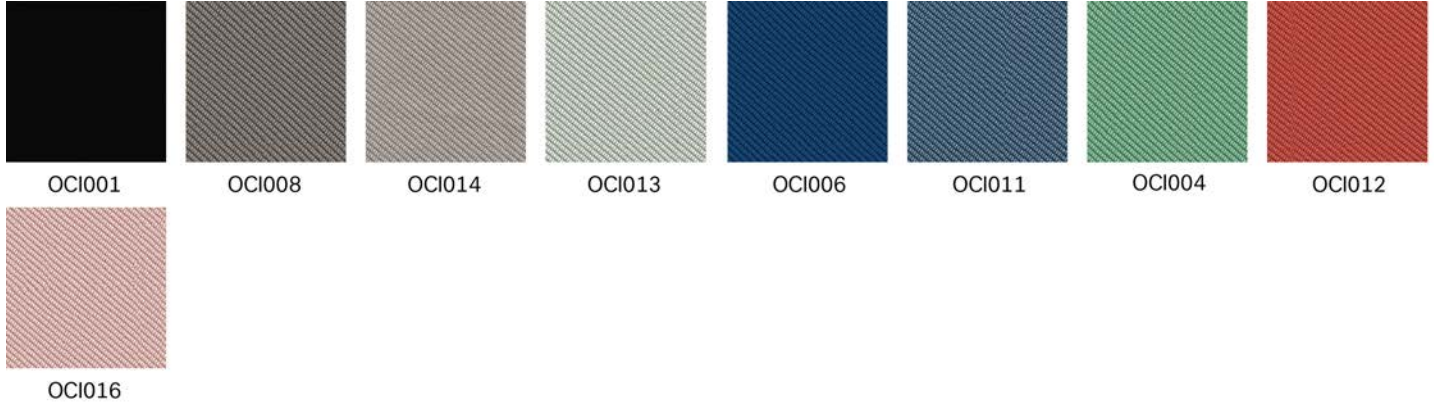

## STEP (GABRIEL) - PRICE GROUP 3

Step is unique in both texture and performance. With its delicate surface, Step is perceived as vivid and interesting. The texture with the fire-resistant Trevira CS yarn ensures that the fabric is suited for use in environments with high fire safety and durability requirements.

**Composition:** 100% Trevira CS

**Weight:** 336 g/m<sup>2</sup>

**Composition:** 100% Trevira cs

**Abrasion resistance:** 100 000 Martindale (EN ISO 12947-2)

**Flammability:** BS EN 1021: 1&2 (Cigarette & match), BS 5852 0&1 (Cigarette & match), BS 5852 Crib 5, CA TB 117-2013, MED Certificate IMO, Class Uno UNI 9175 Class 1 EMME, ÖNORM

**Light fastness:** 5-7 (EN ISO 105 - B02)

**Rubbing fastness:** 4-5/4-5 (Wet/Dry) (EN ISO 105X12)

**Pilling:** 4-5 (EN ISO 12945-2)

**Environmental facts:** EU Ecolabel, Oeko-Tex® Standard 100, 100% free of heavy metals, ISO 14001 certified company

**Design:** Inger Mosholt Nielsen

**Produced in:** Lithuania

**Cleaning:** Professional dry cleaning (For further info follow Gabriel's cleaning guidelines [www.gabriel.dk](http://www.gabriel.dk))

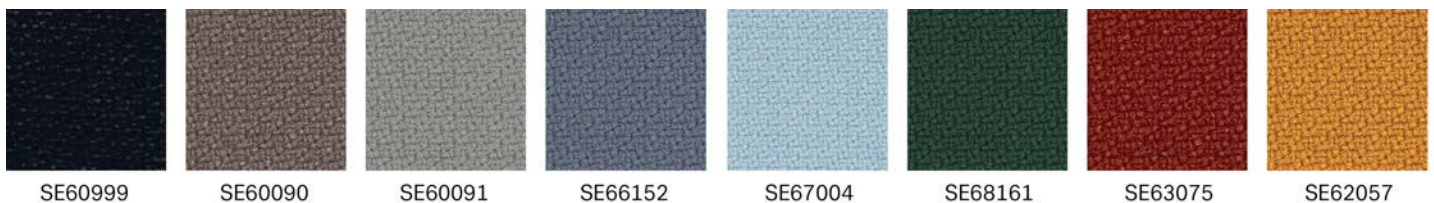

## SYNERGY (CAMIRA) - PRICE GROUP 3

Epitomising natural simplicity, Synergy is a wool rich fabric which is at once both irresistibly soft and ultra-high performing. Delicately felted, with a beautifully relaxed drape, the understated aesthetics showcase the intriguing coloration of this considered textile.

---

**Composition:**

- 95% wool
- 5% polyamide
- **Weight:** 400 g/m<sup>2</sup>

---

**Certificates:**

- **Abrasion resistance:** 100000 Martindale cycles (BS-EN ISO 12947-2)
- **Pilling resistance:** 4 (BS-EN ISO 12945-2)
- **Flammability:** cigarette (BS-EN 1021-1)
- **Flammability:** match (BS-EN 1021-2)
- **Flammability:** (UNI 9175 Class 1IM)
- **Light fastness:** 5 (ISO 105-B02)
- **Maintenance:**
  - -vacuum regularly
  - -use dry-clean preparations
  - -do not bleach

---

Because of the fact that the fabric Synergy is composed of 95% natural fiber, each of the batches shows variations in shade, which may be visible in products of follow-up orders. Additionally, an inherent feature of all natural fibers is the tendency to delicate fabric pilling.

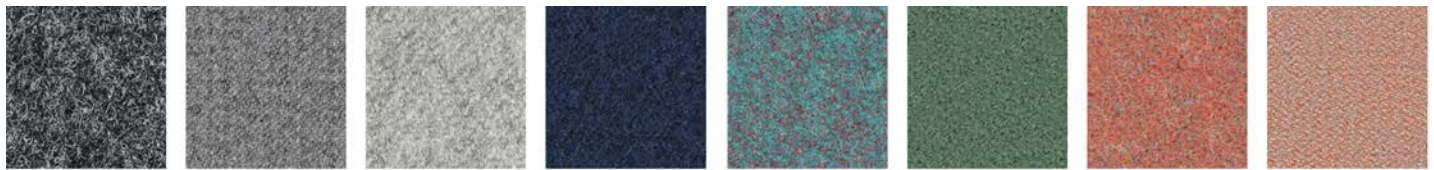

SGY017

SGY016

SGY008

SGY062

SGY056

SGY049

SGY073

SGY074

## STEELCUT 3 (KVADRAT) - PRICE GROUP 4

Steelcut 3 is a unicoloured strong worsted wool and polyamide woven fabric, combining durability, soft touch and colour depth. The construction create a three-dimensional surface resembling small pyramids or steel points. Despite its complex weaving technique, it has a simple and precise expression.

**Composition:** 90% worsted new wool, 10% polyamide

**Weight:** 825 g/lm

**Abrasion resistance:** 100 000 Martindale (EN ISO 12947-2)

**Flammability:** BS EN 1021: 1-2 (Cigarette & match, CA TB 117-2013, BS 5852 Crib 5 (with treatment), BS 5852 part 1, IMO FTP Code 2010 Part 8, NF D 60 013, NFPA 260, UNI 9175 1IM, ÖNORM B1/Q1, AS/NZS 3837 Class 2, ASTM E84 Class A Unadhered, ASTM 84 Class B Adhered

**Light fastness:** 5 6 (EN ISO 105-B02)

**Rubbing fastness:** 3-5/4-5 (Wet/Dry) (EN ISO 105X12)

**Pilling:** 3-4 (EN ISO 12945-2)

**Environmental facts:** EU Ecolabel, 100% free of heavy metals, ISO 14001 certified company, GREENGUARD Gold

**Design:** Frans Dijkmeijer, Giulio Ridolfo (updated colourways)

**Produced in:** United Kingdom

**Cleaning:** Professional dry cleaning with tetrachloroethylene, normal process (For further info follow Kvadrat´s cleaning guidelines – [www.kvadrat.dk](http://www.kvadrat.dk))



STT190

STT655

## STEELCUT TRIO 3 (KVADRAT) - PRICE GROUP 4

Steelcut Trio 3 is a strong worsted wool and polyamide woven fabric, made with three different coloured yarns. The colours and the special weave create a three-dimensional surface where the colours seem to change depending on the angle of perspective. Like Steelcut 3, despite the complexity of the textile's innovative weave, it has a simple, precise expression.

**Composition:** 90% worsted new wool, 10% polyamide

**Weight:** 770 g/lm

**Abrasion resistance:** 100 000 Martindale (EN ISO 12947-2)

**Flammability:** BS EN 1021: 1-2 (Cigarette & match, CA TB 117-2013, . BS 5852 Crib 5 (with treatment), BS 5852 part 1, BS 5852 ignition source 3, IMO FTP Code 2010 Part 8, NF D 60 013, NFPA 260, UNI 9175 1IM, ÖNORM B1/Q1, AS/NZS 3837 Class 2, GB 50222 B1 with treatment (Chinese)

**Light fastness:** 6-7 (EN ISO 105-B02)

**Rubbing fastness:** 3-5/4-5 (Wet/Dry) (EN ISO 105X12)

**Pilling:** 4 (EN ISO 12945-2)

**Environmental facts:** EU Ecolabel, 100% free of heavy metals, ISO 14001 certified company, GREENGUARD Gold

**Design:** Frans Dijkmeijer, Giulio Ridolfo (updated colourways)

**Produced in:** United Kingdom

**Cleaning:** Professional dry cleaning with tetrachloroethylene, normal process (For further info follow Kvadrat's cleaning guidelines – [www.kvadrat.dk](http://www.kvadrat.dk))

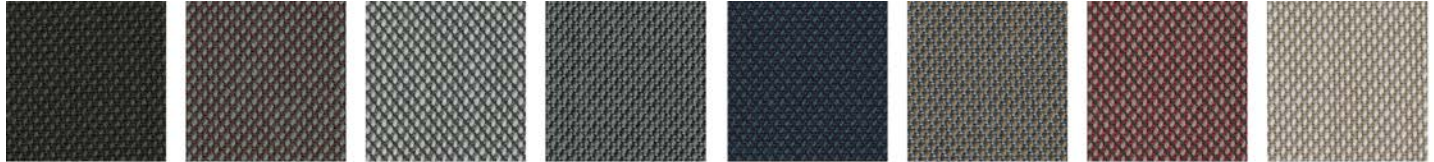

STT383

STT276

STT133

STT153

STT796

STT253

STT645

STT213

## PALOMA SOFT (WOLLSDORF) - PRICE GROUP 6

High quality semi-aniline leather. All our standard colours from Paloma have a special finish adding a particular softness to the leather. Excellent friction and breathing properties. The surface may feature small scars and marks resulting from insect bites etc. These are proof of the natural origin of the product and are part of its character.

**Flammability:** BS EN 1021: 1-2 (Cigarette & match), BS 5852 Crib 5, IMO A.652 (16)

**Light fastness:** 6 (EN ISO 105-B02)

**Rubbing:** Wet 80/4 -Dry 2000/4 - Sweat 50/4 - ISO 11640

**Finish-adhesion:** 2.0 N/cm ISO 11644

**Tear-strength:** 20 N/mm DIN 53329- A

**Environmental facts:** Tanned without using chromium salts, BlueAngel, ECO2L-certificate, ISO 14001 certified company

**Produced in:** Austria

**Animal Welfare:** All hides are by-products from the meat and dairy industries, only use hides from healthy and uninjured animal. Following European standards as a minimum and the "Five Freedoms" of livestock as defined by FAWC (Farm Animal Welfare Council)

**Cleaning:** Follow the leather care guide from our supplier – [www.wollsdorf.com](http://www.wollsdorf.com)



ATG56100

ATG55185

ATG55206

ATG55115

ATG55130



# Fabrics and finishings

## Mesh

Action

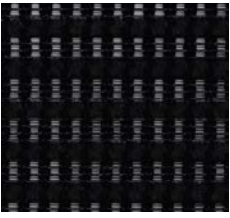

GZ-21

## Mesh

Veris



Runner 60061

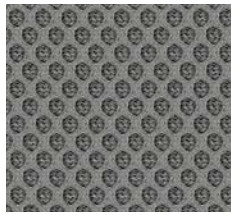

Runner 60011

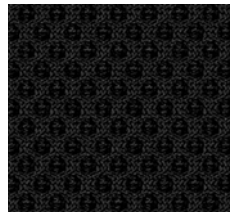

Runner 60999

## Mesh

LightUp / Xenon Net



Runner 60061

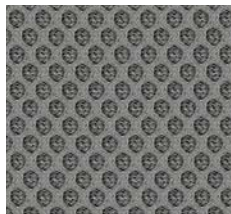

Runner 60011



Runner 60999

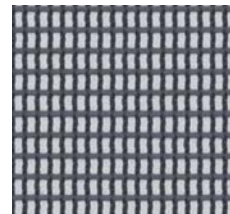

String 60118

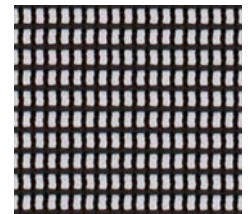

String 60999

# Fabrics and finishings

## Mesh

Accis<sup>Pro</sup> / Violle

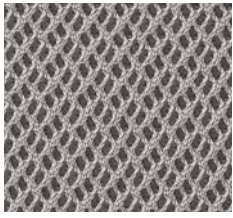

Rhythm 60165



Rhythm 60176



Rhythm 60999



Rhythm 66152

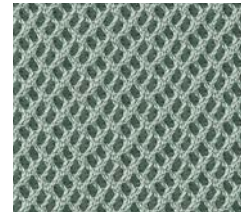

Rhythm 68121



Rhythm 63067



Runner 60061

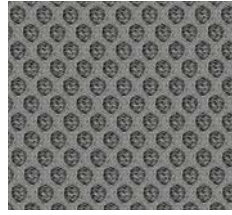

Runner 60011

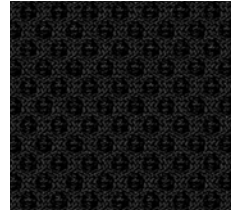

Runner 60999

## Plastics

Accis<sup>Pro</sup> / Light<sup>Up</sup> / Violle

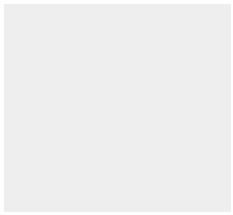

Light grey (RAL 7047)



Black

# Fabrics - Extended

Lead time 30-40 working days

- Legend: ● Possibility of making the product in the given upholstery  
 ○ Possibility of making only the seat in the given upholstery  
 - Impossibility of making a product in a given upholstery

|                      | <b>Camira</b> | Blazer (PG 3) | Era (PG 3) | Halcyon (PG 3) | Main Line Flax (PG 3) | Rivet (PG 3) | Urban (PG 3) | X2 (PG 3) | <b>Gabriel</b> | Breeze Fusion (PG 4) | Chili (PG 3) | Comfort+ (PG 5) | Crisp (PG 3) | Fame (PG 3) | Focus (PG 3) | Focus Melange (PG 3) | Go_Check (PG 3) | Go_Couture (PG 3) | Go_Uni (PG 3) | Just (PG 3) | Mica (PG 3) | Step Melange (PG 3) |
|----------------------|---------------|---------------|------------|----------------|-----------------------|--------------|--------------|-----------|----------------|----------------------|--------------|-----------------|--------------|-------------|--------------|----------------------|-----------------|-------------------|---------------|-------------|-------------|---------------------|
| Accis <sup>Pro</sup> | ●             | ●             | ●          | ●              | ●                     | ●            | ●            | ●         | -              | ●                    | ●            | ●               | -            | ●           | ●            | ●                    | ●               | ●                 | ●             | ●           | ●           | ●                   |
| Action               | ●             | ●             | -          | ●              | ●                     | ●            | ●            | ●         | -              | ●                    | ●            | ●               | -            | ●           | ●            | ●                    | ●               | ●                 | ●             | ●           | ●           | ●                   |
| LightUp              | ●             | ●             | -          | ●              | ●                     | ●            | ●            | ●         | -              | ●                    | ●            | ●               | -            | ●           | ●            | ●                    | ●               | ●                 | ●             | ●           | ●           | ●                   |
| Motto                | ●             | ●             | ●          | ●              | ●                     | ●            | ●            | ●         | ●              | ●                    | ●            | ●               | ●            | ●           | ●            | ●                    | ●               | ●                 | ●             | ●           | ●           | ●                   |
| MyTurn               | ●             | ●             | -          | ●              | ●                     | ●            | ●            | ●         | ●              | ●                    | ●            | ●               | ●            | ●           | ●            | ●                    | ●               | ●                 | ●             | ●           | ●           | ●                   |
| Veris Net            | ●             | ●             | ●          | ●              | ●                     | ●            | ●            | ●         | -              | ●                    | ●            | ●               | -            | ●           | ●            | ●                    | ●               | ●                 | ●             | ●           | ●           | ●                   |
| Violle               | ●             | ●             | ●          | ●              | ●                     | ●            | ●            | ●         | -              | ●                    | ●            | ●               | -            | ●           | ●            | ●                    | ●               | ●                 | ●             | ●           | ●           | ●                   |
| Xenon                | ●             | ●             | ●          | ●              | ●                     | ●            | ●            | ●         | -              | ●                    | ●            | ●               | -            | ●           | ●            | ●                    | ●               | ●                 | ●             | ●           | ●           | ●                   |
| Xenon Net            | ●             | ●             | ●          | ●              | ●                     | ●            | ●            | ●         | -              | ●                    | ●            | ●               | -            | ●           | ●            | ●                    | ●               | ●                 | ●             | ●           | ●           | ●                   |

# Fabrics - Extended

Lead time 30-40 working days

| Kvadrat |              |               |             |                       |               |                 |                      |                    |              |               |                | Sanwil | Softline (PG 1) | Skai |                    |               |              |                 |                      |
|---------|--------------|---------------|-------------|-----------------------|---------------|-----------------|----------------------|--------------------|--------------|---------------|----------------|--------|-----------------|------|--------------------|---------------|--------------|-----------------|----------------------|
|         | Atlas (PG 3) | Canvas (PG 4) | Coda (PG 6) | Divina Melange (PG 5) | Divina (PG 5) | Divina MD(PG 5) | Hallingdal 65 (PG 5) | Melange Nap (PG 4) | Remix (PG 3) | Revive (PG 3) | Re-wool (PG 3) |        |                 |      | Twill Weave (PG 5) | Palena (PG 3) | Palma (PG 3) | Parolega (PG 3) | Sotega (PG 3)        |
|         | ●            | ●             | ●           | ●                     | ●             | -               | -                    | ●                  | ●            | ●             | ●              | ●      | ●               |      | ●                  | ●             | ●            | ●               | Accis <sup>Pro</sup> |
|         | ●            | ●             | -           | ●                     | ●             | -               | -                    | ●                  | ●            | ●             | ●              | ●      | ●               |      | ●                  | -             | ●            | ●               | Action               |
|         | ●            | ●             | ○           | ○                     | ○             | -               | -                    | ●                  | ●            | ●             | ○              | ○      | ●               |      | ○                  | -             | ○            | ●               | LightUp              |
|         | ●            | ●             | -           | ●                     | ●             | ●               | ●                    | ●                  | ●            | ●             | ●              | ●      | ●               |      | ●                  | ●             | ●            | ●               | Motto                |
|         | ●            | ●             | ●           | ●                     | ●             | ●               | ●                    | ●                  | ●            | ●             | ●              | ●      | ●               |      | -                  | -             | ●            | -               | MyTurn               |
|         | ●            | ●             | -           | ●                     | ●             | -               | -                    | ●                  | ●            | ●             | ●              | ●      | ●               |      | ●                  | ●             | ●            | ●               | Veris Net            |
|         | ●            | ●             | ●           | ●                     | ●             | -               | -                    | ●                  | ●            | ●             | ●              | ●      | ●               |      | ●                  | ●             | ●            | ●               | Violle               |
|         | ●            | ●             | ●           | ●                     | ●             | -               | -                    | ●                  | ●            | ●             | ●              | ●      | ●               |      | ●                  | ●             | ●            | ●               | Xenon                |
|         | ●            | ●             | ●           | ●                     | ●             | -               | -                    | ●                  | ●            | ●             | ●              | ●      | ●               |      | ●                  | ●             | ●            | ●               | Xenon Net            |



























# Fabrics - Extended

Lead time 30-40 working days

- Legend:
- Possibility of making the product in the given upholstery
  - Possibility of making only the seat in the given upholstery
  - Impossibility of making a product in a given upholstery

|                      | <b>Spradling</b> |                  |                     |                    |  | <b>Svensson</b> |               |   | <b>Textafoam</b> |  |
|----------------------|------------------|------------------|---------------------|--------------------|--|-----------------|---------------|---|------------------|--|
|                      | Chronos (PG 3)   | Silvertex (PG 3) | Silvertex B1 (PG 3) | Valencia B1 (PG 3) |  | Semi (PG 3)     | Velvet (PG 1) |   |                  |  |
| Accis <sup>Pro</sup> | ●                | ●                | ●                   | ●                  |  | ●               |               | ● |                  |  |
| Action               | ○                | ●                | ●                   | ●                  |  | ●               |               | - |                  |  |
| LightUp              | ○                | ○                | ●                   | ●                  |  | ●               |               | ● |                  |  |
| Motto                | ●                | ●                | ●                   | ●                  |  | ●               |               | ● |                  |  |
| MyTurn               | -                | ●                | -                   | -                  |  | ●               |               | - |                  |  |
| Veris Net            | ●                | ●                | ●                   | ●                  |  | ●               |               | - |                  |  |
| Violle               | ●                | ●                | ●                   | ●                  |  | ●               |               | ● |                  |  |
| Xenon                | ●                | ●                | ●                   | ●                  |  | ●               |               | ● |                  |  |
| Xenon Net            | ●                | ●                | ●                   | ●                  |  | ●               |               | ● |                  |  |

# Legend

|  |  |   |  |
|--|--|---|--|
|  20,0 | net weight   |    | Ergonomie geprüft                        |
|  22,5 | gross weight   |    | GS (geprüfte Sicherheit)                 |
|  10   | stacking (max. quantity)   |    | Quality Office                           |
|  15   | stacking on trolley for transportation (max. quantity)                                   |    | MöBELFAKTA                               |
|       | right-sided table top  |    | The Blue Angel                           |
|       | left-sided table top   |   |  |
|       | joining in rows  |   | Forest Stewardship Council®              |
|       | two-colour upholstery  |  | Environmental Product Declarations (EPD) |
|      | teflon glides  |   |  |
|     | felt glides  |   |  |
|     | special threads  |   |  |
|     | clothes hanger   |   |  |
|     | Mediaport  |   |  |
|     | guarantee period   |   |  |
|     | ISO 9001   |   |  |
|     | ISO 14001  |   |  |
|     | Chrom (III)  |   |  |
|     | The mark of responsible forestry.<br>Concerns only products indicated as FSC® certified. |   |  |

Office

Flokk AB  
Rosenlundsgatan 40,  
trapphus B, vån 3  
118 52 Stockholm  
Sweden

Social Media

Facebook  
YouTube  
Instagram  
Pinterest  
LinkedIn

Factory

Flokk AB  
Vallgatan 1  
571 41 Nässjö  
Sweden